



NVIDIA cuDNN

API Reference | NVIDIA Docs

Table of Contents

Chapter 1. Introduction.....	1
Chapter 2. Added, Deprecated, And Removed API Functions.....	2
2.1. API Changes For cuDNN 8.2.0.....	2
2.2. API Changes For cuDNN 8.0.3.....	2
2.3. API Changes For cuDNN 8.0.2.....	3
2.4. API Changes For cuDNN 8.0.0 Preview.....	3
Chapter 3. cudnn_ops_infer.so Library.....	8
3.1. Data Type References.....	8
3.1.1. Pointer To Opaque Struct Types.....	8
3.1.2. Enumeration Types.....	10
3.2. API Functions.....	24
Chapter 4. cudnn_ops_train.so Library.....	108
4.1. API Functions.....	108
Chapter 5. cudnn_cnn_infer.so Library.....	154
5.1. Data Type References.....	154
5.1.1. Pointer To Opaque Struct Types.....	154
5.1.2. Struct Types.....	154
5.1.3. Enumeration Types.....	156
5.1.4. Data Types Found In cudnn_backend.h.....	164
5.2. API Functions.....	165
Chapter 6. cudnn_cnn_train.so Library.....	224
6.1. Data Type References.....	224
6.1.1. Pointer To Opaque Struct Types.....	224
6.1.2. Struct Types.....	224
6.1.3. Enumeration Types.....	225
6.2. API Functions.....	255
Chapter 7. cudnn_adv_infer.so Library.....	279
7.1. Data Type References.....	279
7.1.1. Pointer To Opaque Struct Types.....	279
7.1.2. Enumeration Types.....	280
7.2. API Functions.....	287
Chapter 8. cudnn_adv_train.so Library.....	363
8.1. Data Type References.....	363
8.1.1. Enumeration Types.....	363

8.2. API Functions.....	364
Chapter 9. cuDNN Backend API.....	430
9.1. Data Type References.....	430
9.2. Backend Descriptor Types.....	431
9.3. Use Cases.....	451
9.3.1. Setting Up An Operation Graph For A Grouped Convolution.....	451
9.3.2. Setting Up An Engine Configuration.....	453
9.3.3. Setting Up And Executing A Plan.....	453

List of Figures

Figure 1. Locations of x , y , h_x , c_x , h_y , and c_y signals in the multi-layer RNN model.328

Figure 2. Data flow when the RNN model is bi-directional. 329

Figure 3. Locations of x , y , h_x , c_x , h_y , c_y , dx , dy , dh_x , dc_x , dhy , and dcy signals a multi-layer RNN model..... 401

List of Tables

Table 1. API functions and data types that were added	2
Table 2. API functions and data types that were added	2
Table 3. API functions and data types that were added	3
Table 4. API functions and data types that were added	3
Table 5. API functions and data types that were deprecated	5
Table 6. API functions and data types that were removed	6
Table 7. Supported configurations	29
Table 8. Supported Datatypes	70
Table 9. Supported configurations	112
Table 10. Supported configurations	116
Table 11. Supported configurations	119
Table 12. Supported configurations	123
Table 13. For 2D convolutions: wDesc: _NHWC	173
Table 14. For 2D convolutions: wDesc: _NCHW	174
Table 15. For 3D convolutions: wDesc: _NCHW	178
Table 16. For 3D convolutions: wDesc: _NHWC	180
Table 17. Supported combinations of data types (X = CUDNN_DATA)	183
Table 18. Supported configurations	186
Table 19. For 2D convolutions: wDesc: _NCHW	189
Table 20. For 2D convolutions: wDesc: _NCHWC	192
Table 21. For 2D convolutions: wDesc: _NHWC	193
Table 22. For 3D convolutions: wDesc: _NCHW	193
Table 23. For 3D convolutions: wDesc: _NHWC	195
Table 24. CUDNN_FUSED_SCALE_BIAS_ACTIVATION_CONV_BNSTATS	228

Table 25. Conditions for Fully Fused Fast Path (Forward)	231
Table 26. CUDNN_FUSED_SCALE_BIAS_ACTIVATION_WGRAD	232
Table 27. Conditions for Fully Fused Fast Path (Backward)	235
Table 28. CUDNN_FUSED_BN_FINALIZE_STATISTICS_TRAINING	236
Table 29. CUDNN_FUSED_BN_FINALIZE_STATISTICS_INFERENCE	240
Table 30. CUDNN_FUSED_CONVOLUTION_SCALE_BIAS_ADD_RELU	242
Table 31. Legend For Tables in This Section	246
Table 32. CUDNN_FUSED_SCALE_BIAS_ACTIVATION_CONV_BNSTATS	246
Table 33. CUDNN_FUSED_SCALE_BIAS_ACTIVATION_WGRAD	248
Table 34. CUDNN_FUSED_BN_FINALIZE_STATISTICS_TRAINING	249
Table 35. CUDNN_FUSED_BN_FINALIZE_STATISTICS_INFERENCE	252
Table 36. CUDNN_FUSED_SCALE_BIAS_ADD_RELU	254
Table 37. For 2D convolutions: dwDesc: _NHWC	259
Table 38. For 2D convolutions: dwDesc: _NCHW	260
Table 39. For 3D convolutions: dwDesc: _NCHW	263
Table 40. For 3D convolutions: dwDesc: _NHWC	264
Table 41. Supported combinations	348
Table 42. The attribute types of cudnnBackendAttributeType_t.	431

Chapter 1. Introduction

NVIDIA® CUDA® Deep Neural Network library™ (cuDNN) offers a context-based API that allows for easy multithreading and (optional) interoperability with NVIDIA® CUDA® streams. The cuDNN Datatypes Reference API describes all the types and enums of the cuDNN library API. The cuDNN API Reference describes the API of all the routines in the cuDNN library.

The cuDNN library as well as this API document has been split into the following libraries:

- ▶ `cuda_ops_infer` - This entity contains the routines related to cuDNN context creation and destruction, tensor descriptor management, tensor utility routines, and the inference portion of common ML algorithms such as batch normalization, softmax, dropout, etc.
- ▶ `cuda_ops_train` - This entity contains common training routines and algorithms, such as batch normalization, softmax, dropout, etc. The `cuda_ops_train` library depends on `cuda_ops_infer`.
- ▶ `cuda_cnn_infer` - This entity contains all routines related to convolutional neural networks needed at inference time. The `cuda_cnn_infer` library depends on `cuda_ops_infer`.
- ▶ `cuda_cnn_train` - This entity contains all routines related to convolutional neural networks needed during training time. The `cuda_cnn_train` library depends on `cuda_ops_infer`, `cuda_ops_train`, and `cuda_cnn_infer`.
- ▶ `cuda_adv_infer` - This entity contains all other features and algorithms. This includes RNNs, CTC loss, and Multihead Attention. The `cuda_adv_infer` library depends on `cuda_ops_infer`.
- ▶ `cuda_adv_train` - This entity contains all the training counterparts of `cuda_adv_infer`. The `cuda_adv_train` library depends on `cuda_ops_infer`, `cuda_ops_train`, and `cuda_adv_infer`.
- ▶ `cuda` - This is an optional shim layer between the application layer and the cuDNN code. This layer opportunistically opens the correct library for the API at runtime.

Chapter 2. Added, Deprecated, And Removed API Functions

2.1. API Changes For cuDNN 8.2.0

The following tables show which API functions were added, deprecated, and removed for the cuDNN 8.2.0.

Table 1. API functions and data types that were added

Backend descriptor types
cudnnGetActivationDescriptorSwishBeta()
cudnnSetActivationDescriptorSwishBeta()

2.2. API Changes For cuDNN 8.0.3

The following tables show which API functions were added, deprecated, and removed for the cuDNN 8.0.3.

Table 2. API functions and data types that were added

Backend descriptor types
CUDNN_BACKEND_CONVOLUTION_DESCRIPTOR
CUDNN_BACKEND_ENGINE_DESCRIPTOR
CUDNN_BACKEND_ENGINECFG_DESCRIPTOR
CUDNN_BACKEND_ENGINEHEUR_DESCRIPTOR
CUDNN_BACKEND_EXECUTION_PLAN_DESCRIPTOR
CUDNN_BACKEND_INTERMEDIATE_INFO_DESCRIPTOR
CUDNN_BACKEND_KNOB_CHOICE_DESCRIPTOR
CUDNN_BACKEND_KNOB_INFO_DESCRIPTOR
CUDNN_BACKEND_LAYOUT_INFO_DESCRIPTOR

Backend descriptor types
CUDNN_BACKEND_OPERATION_CONVOLUTION_BACKWARD_DATA_DESCRIPTOR
CUDNN_BACKEND_OPERATION_CONVOLUTION_BACKWARD_FILTER_DESCRIPTOR
CUDNN_BACKEND_OPERATION_CONVOLUTION_FORWARD_DESCRIPTOR
CUDNN_BACKEND_OPERATION_GEN_STATS_DESCRIPTOR
CUDNN_BACKEND_OPERATION_POINTWISE_DESCRIPTOR
CUDNN_BACKEND_OPERATIONGRAPH_DESCRIPTOR
CUDNN_BACKEND_TENSOR_DESCRIPTOR
CUDNN_BACKEND_VARIANT_PACK_DESCRIPTOR

2.3. API Changes For cuDNN 8.0.2

The following tables show which API functions were added, deprecated, and removed for the cuDNN 8.0.2.

Table 3. API functions and data types that were added

New functions and data types
cudnnRNNBackwardData_v8()
cudnnRNNBackwardWeights_v8()

2.4. API Changes For cuDNN 8.0.0 Preview

The following tables show which API functions were added, deprecated, and removed for the cuDNN 8.0.0 Preview Release.

Table 4. API functions and data types that were added

New functions and data types
cudnnAdvInferVersionCheck()
cudnnAdvTrainVersionCheck()
cudnnBackendAttributeName_t
cudnnBackendAttributeType_t
cudnnBackendCreateDescriptor()
cudnnBackendDescriptor_t
cudnnBackendDescriptorType_t
cudnnBackendDestroyDescriptor()

New functions and data types

cudnnBackendExecute()
cudnnBackendFinalize()
cudnnBackendGetAttribute()
cudnnBackendHeurMode_t
cudnnBackendInitialize()
cudnnBackendKnobType_t
cudnnBackendLayoutType_t
cudnnBackendNumericalNote_t
cudnnBackendSetAttribute()
cudnnBuildRNNDynamic()
cudnnCTCLoss_v8()
cudnnDeriveNormTensorDescriptor()
cudnnForwardMode_t
cudnnGenStatsMode_t
cudnnGetCTCLossDescriptor_v8()
cudnnGetCTCLossDescriptorEx()
cudnnGetCTCLossWorkspaceSize_v8
cudnnGetFilterSizeInBytes()
cudnnGetFoldedConvBackwardDataDescriptors()
cudnnGetNormalizationBackwardWorkspaceSize()
cudnnGetNormalizationForwardTrainingWorkspaceSize()
cudnnGetNormalizationTrainingReserveSpaceSize()
cudnnGetRNNDescriptor_v8()
cudnnGetRNNMatrixMathType()
cudnnGetRNNTempSpaceSizes()
cudnnGetRNNWeightParams()
cudnnGetRNNWeightSpaceSize()
cudnnLRNDescriptor_t
cudnnNormAlgo_t
cudnnNormalizationBackward()
cudnnNormalizationForwardInference()
cudnnNormalizationForwardTraining()
cudnnNormMode_t
cudnnNormOps_t
cudnnOpsInferVersionCheck()
cudnnOpsTrainVersionCheck()
cudnnPointwiseMode_t
cudnnRNNForward()

New functions and data types
cudnnRNNGetClip_v8()
cudnnRNNSetClip_v8()
cudnnSetCTCLossDescriptor_v8()
cudnnSetRNNDescriptor_v8()
cudnnSeverity_t

For our deprecation policy, refer to the [Backward Compatibility And Deprecation Policy](#) section in the *cuDNN Developer Guide*.

Table 5. API functions and data types that were deprecated

Deprecated functions and data types	Replaced with
<code>cudnnCopyAlgorithmDescriptor()</code>	
<code>cudnnCreateAlgorithmDescriptor()</code>	
<code>cudnnCreatePersistentRNNPlan()</code>	cudnnBuildRNNDynamic()
<code>cudnnDestroyAlgorithmDescriptor()</code>	
<code>cudnnDestroyPersistentRNNPlan()</code>	
<code>cudnnFindRNNBackwardDataAlgorithmEx()</code>	
<code>cudnnFindRNNBackwardWeightsAlgorithmEx()</code>	
<code>cudnnFindRNNForwardInferenceAlgorithmEx()</code>	
<code>cudnnFindRNNForwardTrainingAlgorithmEx()</code>	
<code>cudnnGetAlgorithmDescriptor()</code>	
<code>cudnnGetAlgorithmPerformance()</code>	
<code>cudnnGetAlgorithmSpaceSize()</code>	
<code>cudnnGetRNNBackwardDataAlgorithmMaxCount()</code>	
<code>cudnnGetRNNBackwardWeightsAlgorithmMaxCount()</code>	
<ul style="list-style-type: none"> ▶ <code>cudnnGetRNNDescriptor_v6()</code> ▶ <code>cudnnGetRNNMatrixMathType()</code> ▶ <code>cudnnGetRNNBiasMode()</code> ▶ <code>cudnnGetRNNPaddingMode()</code> ▶ <code>cudnnGetRNNProjectionLayers()</code> 	cudnnGetRNNDescriptor_v8()
<code>cudnnGetRNNForwardInferenceAlgorithmMaxCount()</code>	
<code>cudnnGetRNNForwardTrainingAlgorithmMaxCount()</code>	
<ul style="list-style-type: none"> ▶ <code>cudnnGetRNNLinLayerBiasParams()</code> ▶ <code>cudnnGetRNNLinLayerMatrixParams()</code> 	cudnnGetRNNWeightParams()
<code>cudnnGetRNNParamsSize()</code>	cudnnGetRNNWeightSpaceSize()

Deprecated functions and data types	Replaced with
<ul style="list-style-type: none"> ▶ <code>cudaGetRNNWorkspaceSize()</code> ▶ <code>cudaGetRNNTrainingReserveSize()</code> 	<code>cudaGetRNNTempSpaceSizes()</code>
<code>cudaPersistentRNNPlan_t</code>	
<code>cudaRestoreAlgorithm()</code>	
<ul style="list-style-type: none"> ▶ <code>cudaRNNBackwardData()</code> ▶ <code>cudaRNNBackwardDataEx()</code> 	<code>cudaRNNBackwardData_v8()</code>
<ul style="list-style-type: none"> ▶ <code>cudaRNNBackwardWeights()</code> ▶ <code>cudaRNNBackwardWeightsEx()</code> 	<code>cudaRNNBackwardWeights_v8()</code>
<ul style="list-style-type: none"> ▶ <code>cudaRNNForwardInference()</code> ▶ <code>cudaRNNForwardInferenceEx()</code> ▶ <code>cudaRNNForwardTraining()</code> ▶ <code>cudaRNNForwardTrainingEx()</code> 	<code>cudaRNNForward()</code>
<code>cudaRNNGetClip()</code>	<code>cudaRNNGetClip_v8()</code>
<code>cudaRNNSetClip()</code>	<code>cudaRNNSetClip_v8()</code>
<code>cudaSaveAlgorithm()</code>	
<code>cudaSetAlgorithmDescriptor()</code>	
<code>cudaSetAlgorithmPerformance()</code>	
<code>cudaSetPersistentRNNPlan()</code>	
<code>cudaSetRNNAlgorithmDescriptor()</code>	
<ul style="list-style-type: none"> ▶ <code>cudaSetRNNBiasMode()</code> ▶ <code>cudaSetRNNDescriptor_v6()</code> ▶ <code>cudaSetRNNMatrixMathType()</code> ▶ <code>cudaSetRNNPaddingMode()</code> ▶ <code>cudaSetRNNProjectionLayers()</code> 	<code>cudaSetRNNDescriptor_v8()</code>

Table 6. API functions and data types that were removed

Removed functions and data types
<code>cudaConvolutionBwdDataPreference_t</code>
<code>cudaConvolutionBwdFilterPreference_t</code>
<code>cudaConvolutionFwdPreference_t</code>
<code>cudaGetConvolutionBackwardDataAlgorithm()</code>
<code>cudaGetConvolutionBackwardFilterAlgorithm()</code>

Removed functions and data types`cudaGetConvolutionForwardAlgorithm()``cudaGetRNNDescriptor()``cudaSetRNNDescriptor()`

Chapter 3. `cuda_ops_infer.so` Library

3.1. Data Type References

3.1.1. Pointer To Opaque Struct Types

3.1.1.1. `cudaActivationDescriptor_t`

`cudaActivationDescriptor_t` is a pointer to an opaque structure holding the description of an activation operation. [`cudaCreateActivationDescriptor\(\)`](#) is used to create one instance, and [`cudaSetActivationDescriptor\(\)`](#) must be used to initialize this instance.

3.1.1.2. `cudaCTCLossDescriptor_t`

`cudaCTCLossDescriptor_t` is a pointer to an opaque structure holding the description of a CTC loss operation. [`cudaCreateCTCLossDescriptor\(\)`](#) is used to create one instance, [`cudaSetCTCLossDescriptor\(\)`](#) is used to initialize this instance, and [`cudaDestroyCTCLossDescriptor\(\)`](#) is used to destroy this instance.

3.1.1.3. `cudaDropoutDescriptor_t`

`cudaDropoutDescriptor_t` is a pointer to an opaque structure holding the description of a dropout operation. [`cudaCreateDropoutDescriptor\(\)`](#) is used to create one instance, [`cudaSetDropoutDescriptor\(\)`](#) is used to initialize this instance, [`cudaDestroyDropoutDescriptor\(\)`](#) is used to destroy this instance, [`cudaGetDropoutDescriptor\(\)`](#) is used to query fields of a previously initialized instance, [`cudaRestoreDropoutDescriptor\(\)`](#) is used to restore an instance to a previously saved off state.

3.1.1.4. `cudaFilterDescriptor_t`

`cudaFilterDescriptor_t` is a pointer to an opaque structure holding the description of a filter dataset. [`cudaCreateFilterDescriptor\(\)`](#) is used to create one instance, and

[cudnnSetFilter4dDescriptor\(\)](#) or [cudnnSetFilterNdDescriptor\(\)](#) must be used to initialize this instance.

3.1.1.5. **cudnnHandle_t**

`cudnnHandle_t` is a pointer to an opaque structure holding the cuDNN library context. The cuDNN library context must be created using [cudnnCreate\(\)](#) and the returned handle must be passed to all subsequent library function calls. The context should be destroyed at the end using [cudnnDestroy\(\)](#). The context is associated with only one GPU device, the current device at the time of the call to [cudnnCreate\(\)](#). However, multiple contexts can be created on the same GPU device.

3.1.1.6. **cudnnLRNDescriptor_t**

`cudnnLRNDescriptor_t` is a pointer to an opaque structure holding the parameters of a local response normalization. [cudnnCreateLRNDescriptor\(\)](#) is used to create one instance, and the routine [cudnnSetLRNDescriptor\(\)](#) must be used to initialize this instance.

3.1.1.7. **cudnnOpTensorDescriptor_t**

`cudnnOpTensorDescriptor_t` is a pointer to an opaque structure holding the description of a Tensor Core operation, used as a parameter to [cudnnOpTensor\(\)](#). [cudnnCreateOpTensorDescriptor\(\)](#) is used to create one instance, and [cudnnSetOpTensorDescriptor\(\)](#) must be used to initialize this instance.

3.1.1.8. **cudnnPoolingDescriptor_t**

`cudnnPoolingDescriptor_t` is a pointer to an opaque structure holding the description of a pooling operation. [cudnnCreatePoolingDescriptor\(\)](#) is used to create one instance, and [cudnnSetPoolingNdDescriptor\(\)](#) or [cudnnSetPooling2dDescriptor\(\)](#) must be used to initialize this instance.

3.1.1.9. **cudnnReduceTensorDescriptor_t**

`cudnnReduceTensorDescriptor_t` is a pointer to an opaque structure holding the description of a tensor reduction operation, used as a parameter to [cudnnReduceTensor\(\)](#). [cudnnCreateReduceTensorDescriptor\(\)](#) is used to create one instance, and [cudnnSetReduceTensorDescriptor\(\)](#) must be used to initialize this instance.

3.1.1.10. **cudnnSpatialTransformerDescriptor_t**

`cudnnSpatialTransformerDescriptor_t` is a pointer to an opaque structure holding the description of a spatial transformation operation. [cudnnCreateSpatialTransformerDescriptor\(\)](#) is used to create one instance, [cudnnSetSpatialTransformerNdDescriptor\(\)](#) is used to initialize this instance, and [cudnnDestroySpatialTransformerDescriptor\(\)](#) is used to destroy this instance.

3.1.1.11. **cudnnTensorDescriptor_t**

`cudaTensorDescriptor_t` is a pointer to an opaque structure holding the description of a generic n-D dataset. [cudaCreateTensorDescriptor\(\)](#) is used to create one instance, and one of the routines [cudaSetTensorNdDescriptor\(\)](#), [cudaSetTensor4dDescriptor\(\)](#) or [cudaSetTensor4dDescriptorEx\(\)](#) must be used to initialize this instance.

3.1.1.12. `cudaTensorTransformDescriptor_t`

`cudaTensorTransformDescriptor_t` is an opaque structure containing the description of the tensor transform. Use the [cudaCreateTensorTransformDescriptor\(\)](#) function to create an instance of this descriptor, and [cudaDestroyTensorTransformDescriptor\(\)](#) function to destroy a previously created instance.

3.1.2. Enumeration Types

3.1.2.1. `cudaActivationMode_t`

`cudaActivationMode_t` is an enumerated type used to select the neuron activation function used in [cudaActivationForward\(\)](#), [cudaActivationBackward\(\)](#), and [cudaConvolutionBiasActivationForward\(\)](#).

Values

CUDNN_ACTIVATION_SIGMOID

Selects the sigmoid function.

CUDNN_ACTIVATION_RELU

Selects the rectified linear function.

CUDNN_ACTIVATION_TANH

Selects the hyperbolic tangent function.

CUDNN_ACTIVATION_CLIPPED_RELU

Selects the clipped rectified linear function.

CUDNN_ACTIVATION_ELU

Selects the exponential linear function.

CUDNN_ACTIVATION_IDENTITY

Selects the identity function, intended for bypassing the activation step in [cudaConvolutionBiasActivationForward\(\)](#). (The [cudaConvolutionBiasActivationForward\(\)](#) function must use `CUDNN_CONVOLUTION_FWD_ALGO_IMPLICIT_PRECOMP_GEMM`.) Does not work with [cudaActivationForward\(\)](#) or [cudaActivationBackward\(\)](#).

3.1.2.2. `cudaAlgorithm_t`

This function has been deprecated in cuDNN 8.0.

3.1.2.3. `cudnnBatchNormMode_t`

`cudnnBatchNormMode_t` is an enumerated type used to specify the mode of operation in [`cudnnBatchNormalizationForwardInference\(\)`](#), [`cudnnBatchNormalizationForwardTraining\(\)`](#), [`cudnnBatchNormalizationBackward\(\)`](#) and [`cudnnDeriveBNTensorDescriptor\(\)`](#) routines.

Values

CUDNN_BATCHNORM_PER_ACTIVATION

Normalization is performed per-activation. This mode is intended to be used after the non-convolutional network layers. In this mode, the tensor dimensions of `bnBias` and `bnScale` and the parameters used in the `cudnnBatchNormalization*` functions, are `1xCxHxW`.

CUDNN_BATCHNORM_SPATIAL

Normalization is performed over N+spatial dimensions. This mode is intended for use after convolutional layers (where spatial invariance is desired). In this mode the `bnBias` and `bnScale` tensor dimensions are `1xCx1x1`.

CUDNN_BATCHNORM_SPATIAL_PERSISTENT

This mode is similar to `CUDNN_BATCHNORM_SPATIAL` but it can be faster for some tasks.

An optimized path may be selected for `CUDNN_DATA_FLOAT` and `CUDNN_DATA_HALF` types, compute capability 6.0 or higher for the following two batch normalization API calls: [`cudnnBatchNormalizationForwardTraining\(\)`](#), and [`cudnnBatchNormalizationBackward\(\)`](#). In the case of [`cudnnBatchNormalizationBackward\(\)`](#), the `savedMean` and `savedInvVariance` arguments should not be `NULL`.

The rest of this section applies to NCHW mode only:

This mode may use a scaled atomic integer reduction that is deterministic but imposes more restrictions on the input data range. When a numerical overflow occurs, the algorithm may produce NaN-s or Inf-s (infinity) in output buffers.

When Inf-s/NaN-s are present in the input data, the output in this mode is the same as from a pure floating-point implementation.

For finite but very large input values, the algorithm may encounter overflows more frequently due to a lower dynamic range and emit Inf-s/NaN-s while `CUDNN_BATCHNORM_SPATIAL` will produce finite results. The user can invoke [`cudnnQueryRuntimeError\(\)`](#) to check if a numerical overflow occurred in this mode.

3.1.2.4. `cudnnBatchNormOps_t`

`cudnnBatchNormOps_t` is an enumerated type used to specify the mode of operation in [`cudnnGetBatchNormalizationForwardTrainingExWorkspaceSize\(\)`](#), [`cudnnBatchNormalizationForwardTrainingEx\(\)`](#), [`cudnnGetBatchNormalizationBackwardExWorkspaceSize\(\)`](#),

[cudaBatchNormalizationBackwardEx\(\)](#), and [cudaGetBatchNormalizationTrainingExReserveSpaceSize\(\)](#) functions.

Values

CUDNN_BATCHNORM_OPS_BN

Only batch normalization is performed, per-activation.

CUDNN_BATCHNORM_OPS_BN_ACTIVATION

First, the batch normalization is performed, and then the activation is performed.

CUDNN_BATCHNORM_OPS_BN_ADD_ACTIVATION

Performs the batch normalization, then element-wise addition, followed by the activation operation.

3.1.2.5. **cudaCTCLossAlgo_t**

`cudaCTCLossAlgo_t` is an enumerated type that exposes the different algorithms available to execute the CTC loss operation.

Values

CUDNN CTC_LOSS_ALGO_DETERMINISTIC

Results are guaranteed to be reproducible.

CUDNN CTC_LOSS_ALGO_NON_DETERMINISTIC

Results are not guaranteed to be reproducible.

3.1.2.6. **cudaDataType_t**

`cudaDataType_t` is an enumerated type indicating the data type to which a tensor descriptor or filter descriptor refers.

Values

CUDNN_DATA_FLOAT

The data is a 32-bit single-precision floating-point (`float`).

CUDNN_DATA_DOUBLE

The data is a 64-bit double-precision floating-point (`double`).

CUDNN_DATA_HALF

The data is a 16-bit floating-point.

CUDNN_DATA_INT8

The data is an 8-bit signed integer.

CUDNN_DATA_UINT8

The data is an 8-bit unsigned integer.

CUDNN_DATA_INT32

The data is a 32-bit signed integer.

CUDNN_DATA_INT8x4

The data is 32-bit elements each composed of 4 8-bit signed integers. This data type is only supported with the tensor format `CUDNN_TENSOR_NCHW_VECT_C`.

CUDNN_DATA_INT8x32

The data is 32-element vectors, each element being an 8-bit signed integer. This data type is only supported with the tensor format `CUDNN_TENSOR_NCHW_VECT_C`. Moreover, this data type can only be used with `algo 1`, meaning, `CUDNN_CONVOLUTION_FWD_ALGO_IMPLICIT_PRECOMP_GEMM`. For more information, see [cudnnConvolutionFwdAlgo_t](#).

CUDNN_DATA_UINT8x4

The data is 32-bit elements each composed of 4 8-bit unsigned integers. This data type is only supported with the tensor format `CUDNN_TENSOR_NCHW_VECT_C`.

CUDNN_DATA_BFLOAT16

The data is a 16-bit quantity, with 7 mantissa bits, 8 exponent bits, and 1 sign bit.

3.1.2.7. `cudnnDeterminism_t`

`cudnnDeterminism_t` is an enumerated type used to indicate if the computed results are deterministic (reproducible). For more information, see [Reproducibility \(determinism\)](#).

Values

CUDNN_NON_DETERMINISTIC

Results are not guaranteed to be reproducible.

CUDNN_DETERMINISTIC

Results are guaranteed to be reproducible.

3.1.2.8. `cudnnDivNormMode_t`

`cudnnDivNormMode_t` is an enumerated type used to specify the mode of operation in [cudnnDivisiveNormalizationForward\(\)](#) and [cudnnDivisiveNormalizationBackward\(\)](#).

Values

CUDNN_DIVNORM_PRECOMPUTED_MEANS

The means tensor data pointer is expected to contain means or other kernel convolution values precomputed by the user. The means pointer can also be `NULL`, in that case, it's considered to be filled with zeroes. This is equivalent to spatial LRN.



Note: In the backward pass, the means are treated as independent inputs and the gradient over means is computed independently. In this mode, to yield a net gradient over the entire LCN computational graph, the `destDiffMeans` result should be backpropagated through the user's means layer (which can be implemented using average pooling) and added to the `destDiffData` tensor produced by `cudaDivisiveNormalizationBackward()`.

3.1.2.9. `cudaErrQueryMode_t`

`cudaErrQueryMode_t` is an enumerated type passed to `cudaQueryRuntimeError()` to select the remote kernel error query mode.

Values

CUDNN_ERRQUERY_RAWCODE

Read the error storage location regardless of the kernel completion status.

CUDNN_ERRQUERY_NONBLOCKING

Report if all tasks in the user stream of the cuDNN handle were completed. If that is the case, report the remote kernel error code.

CUDNN_ERRQUERY_BLOCKING

Wait for all tasks to complete in the user stream before reporting the remote kernel error code.

3.1.2.10. `cudaFoldingDirection_t`

`cudaFoldingDirection_t` is an enumerated type used to select the folding direction. For more information, see `cudaTensorTransformDescriptor_t`.

Data Member

CUDNN_TRANSFORM_FOLD = 0U

Selects folding.

CUDNN_TRANSFORM_UNFOLD = 1U

Selects unfolding.

3.1.2.11. `cudaIndiceType_t`

`cudaIndiceType_t` is an enumerated type used to indicate the data type for the indices to be computed by the `cudaReduceTensor()` routine. This enumerated type is used as a field for the `cudaReduceTensorDescriptor_t` descriptor.

Values

CUDNN_32BIT_INDICES

Compute unsigned int indices.

CUDNN_64BIT_INDICES

Compute unsigned long indices.

CUDNN_16BIT_INDICES

Compute unsigned short indices.

CUDNN_8BIT_INDICES

Compute unsigned char indices.

3.1.2.12. `cudaLRNMode_t`

`cudaLRNMode_t` is an enumerated type used to specify the mode of operation in `cudaLRNCrossChannelForward()` and `cudaLRNCrossChannelBackward()`.

Values

CUDNN_LRN_CROSS_CHANNEL_DIM1

LRN computation is performed across tensor's dimension `dimA[1]`.

3.1.2.13. `cudaMathType_t`

`cudaMathType_t` is an enumerated type used to indicate if the use of Tensor Core operations is permitted in a given library routine.

Values

CUDNN_DEFAULT_MATH

Tensor Core operations are not used on pre-NVIDIA A100 GPU devices. On A100 GPU architecture devices, Tensor Core TF32 operation is permitted.

CUDNN_TENSOR_OP_MATH

The use of Tensor Core operations is permitted but will not actively perform datatype down conversion on tensors in order to utilize Tensor Cores.

CUDNN_TENSOR_OP_MATH_ALLOW_CONVERSION

The use of Tensor Core operations is permitted and will actively perform datatype down conversion on tensors in order to utilize Tensor Cores.

CUDNN_FMA_MATH

Restricted to only kernels that use FMA instructions.

On pre-NVIDIA A100 GPU devices, CUDNN_DEFAULT_MATH and CUDNN_FMA_MATH have the same behavior: Tensor Core kernels will not be selected. With NVIDIA Ampere GPU architecture and CUDA Toolkit 11, CUDNN_DEFAULT_MATH permits TF32 Tensor Core operation and CUDNN_FMA_MATH does not. The TF32 behavior for CUDNN_DEFAULT_MATH can be explicitly disabled by the environment variable NVIDIA_TF32_OVERRIDE=0.

3.1.2.14. cudnnNanPropagation_t

cudnnNanPropagation_t is an enumerated type used to indicate if a given routine should propagate Nan numbers. This enumerated type is used as a field for the cudnnActivationDescriptor_t descriptor and cudnnPoolingDescriptor_t descriptor.

Values

CUDNN_NOT_PROPAGATE_NAN

Nan numbers are not propagated.

CUDNN_PROPAGATE_NAN

Nan numbers are propagated.

3.1.2.15. cudnnNormAlgo_t

cudnnNormAlgo_t is an enumerated type used to specify the algorithm to execute the normalization operation.

Values

CUDNN_NORM_ALGO_STANDARD

Standard normalization is performed.

CUDNN_NORM_ALGO_PERSIST

This mode is similar to CUDNN_NORM_ALGO_STANDARD, however it only supports CUDNN_NORM_PER_CHANNEL and can be faster for some tasks.

An optimized path may be selected for CUDNN_DATA_FLOAT and CUDNN_DATA_HALF types, compute capability 6.0 or higher for the following two normalization API calls: [cudnnNormalizationForwardTraining\(\)](#) and [cudnnNormalizationBackward\(\)](#). In the case of [cudnnNormalizationBackward\(\)](#), the savedMean and savedInvVariance arguments should not be NULL.

The rest of this section applies to NCHW mode only: This mode may use a scaled atomic integer reduction that is deterministic but imposes more restrictions on the input data range. When a numerical overflow occurs, the algorithm may produce NaN-s or Inf-s (infinity) in output buffers.

When Inf-s/NaN-s are present in the input data, the output in this mode is the same as from a pure floating-point implementation.

For finite but very large input values, the algorithm may encounter overflows more frequently due to a lower dynamic range and emit Inf-s/NaN-s while CUDNN_NORM_ALGO_STANDARD will produce finite results. The user can invoke [cudaQueryRuntimeError\(\)](#) to check if a numerical overflow occurred in this mode.

3.1.2.16. [cudaNormMode_t](#)

[cudaNormMode_t](#) is an enumerated type used to specify the mode of operation in [cudaNormalizationForwardInference\(\)](#), [cudaNormalizationForwardTraining\(\)](#), [cudaBatchNormalizationBackward\(\)](#), [cudaGetNormalizationForwardTrainingWorkspaceSize\(\)](#), [cudaGetNormalizationBackwardWorkspaceSize\(\)](#), and [cudaGetNormalizationTrainingReserveSpaceSize\(\)](#) routines.

Values

CUDNN_NORM_PER_ACTIVATION

Normalization is performed per-activation. This mode is intended to be used after the non-convolutional network layers. In this mode, the tensor dimensions of `normBias` and `normScale` and the parameters used in the `cudaNormalization*` functions, are 1xCxHxW.

CUDNN_NORM_PER_CHANNEL

Normalization is performed per-channel over N+spatial dimensions. This mode is intended for use after convolutional layers (where spatial invariance is desired). In this mode, the `normBias` and `normScale` tensor dimensions are 1xCx1x1.

3.1.2.17. [cudaNormOps_t](#)

[cudaNormOps_t](#) is an enumerated type used to specify the mode of operation in [cudaGetNormalizationForwardTrainingWorkspaceSize\(\)](#), [cudaNormalizationForwardTraining\(\)](#), [cudaGetNormalizationBackwardWorkspaceSize\(\)](#), [cudaNormalizationBackward\(\)](#), and [cudaGetNormalizationTrainingReserveSpaceSize\(\)](#) functions.

Values

CUDNN_NORM_OPS_NORM

Only normalization is performed.

CUDNN_NORM_OPS_NORM_ACTIVATION

First, the normalization is performed, then the activation is performed.

CUDNN_NORM_OPS_NORM_ADD_ACTIVATION

Performs the normalization, then element-wise addition, followed by the activation operation.

3.1.2.18. cudnnOpTensorOp_t

cudnnOpTensorOp_t is an enumerated type used to indicate the Tensor Core operation to be used by the [cudnnOpTensor\(\)](#) routine. This enumerated type is used as a field for the [cudnnOpTensorDescriptor_t](#) descriptor.

Values

CUDNN_OP_TENSOR_ADD

The operation to be performed is addition.

CUDNN_OP_TENSOR_MUL

The operation to be performed is multiplication.

CUDNN_OP_TENSOR_MIN

The operation to be performed is a minimum comparison.

CUDNN_OP_TENSOR_MAX

The operation to be performed is a maximum comparison.

CUDNN_OP_TENSOR_SQRT

The operation to be performed is square root, performed on only the A tensor.

CUDNN_OP_TENSOR_NOT

The operation to be performed is negation, performed on only the A tensor.

3.1.2.19. cudnnPoolingMode_t

cudnnPoolingMode_t is an enumerated type passed to [cudnnSetPooling2dDescriptor\(\)](#) to select the pooling method to be used by [cudnnPoolingForward\(\)](#) and [cudnnPoolingBackward\(\)](#).

Values

CUDNN_POOLING_MAX

The maximum value inside the pooling window is used.

CUDNN_POOLING_AVERAGE_COUNT_INCLUDE_PADDING

Values inside the pooling window are averaged. The number of elements used to calculate the average includes spatial locations falling in the padding region.

CUDNN_POOLING_AVERAGE_COUNT_EXCLUDE_PADDING

Values inside the pooling window are averaged. The number of elements used to calculate the average excludes spatial locations falling in the padding region.

CUDNN_POOLING_MAX_DETERMINISTIC

The maximum value inside the pooling window is used. The algorithm used is deterministic.

3.1.2.20. **cudaReduceTensorIndices_t**

cudaReduceTensorIndices_t is an enumerated type used to indicate whether indices are to be computed by the [cudaReduceTensor\(\)](#) routine. This enumerated type is used as a field for the [cudaReduceTensorDescriptor_t](#) descriptor.

Values

CUDNN_REDUCE_TENSOR_NO_INDICES

Do not compute indices.

CUDNN_REDUCE_TENSOR_FLATTENED_INDICES

Compute indices. The resulting indices are relative, and flattened.

3.1.2.21. **cudaReduceTensorOp_t**

cudaReduceTensorOp_t is an enumerated type used to indicate the Tensor Core operation to be used by the [cudaReduceTensor\(\)](#) routine. This enumerated type is used as a field for the [cudaReduceTensorDescriptor_t](#) descriptor.

Values

CUDNN_REDUCE_TENSOR_ADD

The operation to be performed is addition.

CUDNN_REDUCE_TENSOR_MUL

The operation to be performed is multiplication.

CUDNN_REDUCE_TENSOR_MIN

The operation to be performed is a minimum comparison.

CUDNN_REDUCE_TENSOR_MAX

The operation to be performed is a maximum comparison.

CUDNN_REDUCE_TENSOR_AMAX

The operation to be performed is a maximum comparison of absolute values.

CUDNN_REDUCE_TENSOR_AVG

The operation to be performed is averaging.

CUDNN_REDUCE_TENSOR_NORM1

The operation to be performed is addition of absolute values.

CUDNN_REDUCE_TENSOR_NORM2

The operation to be performed is a square root of the sum of squares.

CUDNN_REDUCE_TENSOR_MUL_NO_ZEROS

The operation to be performed is multiplication, not including elements of value zero.

3.1.2.22. **cudnnRNNAlgo_t**

`cudnnRNNAlgo_t` is an enumerated type used to specify the algorithm used in the `cudnnRNNForwardInference()`, `cudnnRNNForwardTraining()`, `cudnnRNNBackwardData()` and `cudnnRNNBackwardWeights()` routines.

Values

CUDNN_RNN_ALGO_STANDARD

Each RNN layer is executed as a sequence of operations. This algorithm is expected to have robust performance across a wide range of network parameters.

CUDNN_RNN_ALGO_PERSIST_STATIC

The recurrent parts of the network are executed using a *persistent kernel* approach. This method is expected to be fast when the first dimension of the input tensor is small (meaning, a small minibatch).

`CUDNN_RNN_ALGO_PERSIST_STATIC` is only supported on devices with compute capability ≥ 6.0 .

CUDNN_RNN_ALGO_PERSIST_DYNAMIC

The recurrent parts of the network are executed using a *persistent kernel* approach. This method is expected to be fast when the first dimension of the input tensor is small (meaning, a small minibatch). When using `CUDNN_RNN_ALGO_PERSIST_DYNAMIC` persistent kernels are prepared at runtime and are able to optimize using the specific parameters of the network and active GPU. As such, when using `CUDNN_RNN_ALGO_PERSIST_DYNAMIC` a one-time plan preparation stage must be executed. These plans can then be reused in repeated calls with the same model parameters.

The limits on the maximum number of hidden units supported when using `CUDNN_RNN_ALGO_PERSIST_DYNAMIC` are significantly higher than the limits when using `CUDNN_RNN_ALGO_PERSIST_STATIC`, however throughput is likely to significantly reduce when exceeding the maximums supported by `CUDNN_RNN_ALGO_PERSIST_STATIC`. In this regime, this method will still outperform `CUDNN_RNN_ALGO_STANDARD` for some cases.

`CUDNN_RNN_ALGO_PERSIST_DYNAMIC` is only supported on devices with compute capability ≥ 6.0 on Linux machines.

3.1.2.23. `cudaSamplerType_t`

`cudaSamplerType_t` is an enumerated type passed to `cudaSetSpatialTransformerNdDescriptor()` to select the sampler type to be used by `cudaSpatialTfSamplerForward()` and `cudaSpatialTfSamplerBackward()`.

Values

CUDNN_SAMPLER_BILINEAR

Selects the bilinear sampler.

3.1.2.24. `cudaSeverity_t`

`cudaSeverity_t` is an enumerated type passed to the customized callback function for logging that users may set. This enumerate describes the severity level of the item, so the customized logging call back may react differently.

Values

CUDNN_SEV_FATAL

This value indicates a fatal error emitted by cuDNN.

CUDNN_SEV_ERROR

This value indicates a normal error emitted by cuDNN.

CUDNN_SEV_WARNING

This value indicates a warning emitted by cuDNN.

CUDNN_SEV_INFO

This value indicates a piece of information (for example, API log) emitted by cuDNN.

3.1.2.25. `cudaSoftmaxAlgorithm_t`

`cudaSoftmaxAlgorithm_t` is used to select an implementation of the softmax function used in `cudaSoftmaxForward()` and `cudaSoftmaxBackward()`.

Values

CUDNN_SOFTMAX_FAST

This implementation applies the straightforward softmax operation.

CUDNN_SOFTMAX_ACCURATE

This implementation scales each point of the softmax input domain by its maximum value to avoid potential floating point overflows in the softmax evaluation.

CUDNN_SOFTMAX_LOG

This entry performs the log softmax operation, avoiding overflows by scaling each point in the input domain as in CUDNN_SOFTMAX_ACCURATE.

3.1.2.26. cudnnSoftmaxMode_t

cudnnSoftmaxMode_t is used to select over which data the [cudnnSoftmaxForward\(\)](#) and [cudnnSoftmaxBackward\(\)](#) are computing their results.

Values

CUDNN_SOFTMAX_MODE_INSTANCE

The softmax operation is computed per image (N) across the dimensions c, H, W.

CUDNN_SOFTMAX_MODE_CHANNEL

The softmax operation is computed per spatial location (H, W) per image (N) across the dimension c.

3.1.2.27. cudnnStatus_t

cudnnStatus_t is an enumerated type used for function status returns. All cuDNN library functions return their status, which can be one of the following values:

Values

CUDNN_STATUS_SUCCESS

The operation was completed successfully.

CUDNN_STATUS_NOT_INITIALIZED

The cuDNN library was not initialized properly. This error is usually returned when a call to [cudnnCreate\(\)](#) fails or when [cudnnCreate\(\)](#) has not been called prior to calling another cuDNN routine. In the former case, it is usually due to an error in the CUDA Runtime API called by [cudnnCreate\(\)](#) or by an error in the hardware setup.

CUDNN_STATUS_ALLOC_FAILED

Resource allocation failed inside the cuDNN library. This is usually caused by an internal `cudaMalloc()` failure.

To correct, prior to the function call, deallocate previously allocated memory as much as possible.

CUDNN_STATUS_BAD_PARAM

An incorrect value or parameter was passed to the function.

To correct, ensure that all the parameters being passed have valid values.

CUDNN_STATUS_ARCH_MISMATCH

The function requires a feature absent from the current GPU device. Note that cuDNN only supports devices with compute capabilities greater than or equal to 3.0.

To correct, compile and run the application on a device with appropriate compute capability.

CUDNN_STATUS_MAPPING_ERROR

An access to GPU memory space failed, which is usually caused by a failure to bind a texture.

To correct, prior to the function call, unbind any previously bound textures.

Otherwise, this may indicate an internal error/bug in the library.

CUDNN_STATUS_EXECUTION_FAILED

The GPU program failed to execute. This is usually caused by a failure to launch some cuDNN kernel on the GPU, which can occur for multiple reasons.

To correct, check that the hardware, an appropriate version of the driver, and the cuDNN library are correctly installed.

Otherwise, this may indicate an internal error/bug in the library.

CUDNN_STATUS_INTERNAL_ERROR

An internal cuDNN operation failed.

CUDNN_STATUS_NOT_SUPPORTED

The functionality requested is not presently supported by cuDNN.

CUDNN_STATUS_LICENSE_ERROR

The functionality requested requires some license and an error was detected when trying to check the current licensing. This error can happen if the license is not present or is expired or if the environment variable `NVIDIA_LICENSE_FILE` is not set properly.

CUDNN_STATUS_RUNTIME_PREREQUISITE_MISSING

The runtime library that is required by RNN calls (`libcuda.so` or `nvcuda.dll`) cannot be found in predefined search paths.

CUDNN_STATUS_RUNTIME_IN_PROGRESS

Some tasks in the user stream are not completed.

CUDNN_STATUS_RUNTIME_FP_OVERFLOW

Numerical overflow occurred during the GPU kernel execution.

3.1.2.28. cudnnTensorFormat_t

`cudnnTensorFormat_t` is an enumerated type used by `cudnnSetTensor4dDescriptor()` to create a tensor with a pre-defined layout. For a detailed explanation of how these tensors are arranged in memory, see the [Data Layout Formats](#) section in the *cuDNN Developer Guide*.

Values

CUDNN_TENSOR_NCHW

This tensor format specifies that the data is laid out in the following order: batch size, feature maps, rows, columns. The strides are implicitly defined in such a way that the data are contiguous in memory with no padding between images, feature maps, rows, and columns; the columns are the inner dimension and the images are the outermost dimension.

CUDNN_TENSOR_NHWC

This tensor format specifies that the data is laid out in the following order: batch size, rows, columns, feature maps. The strides are implicitly defined in such a way that the data are contiguous in memory with no padding between images, rows, columns, and feature maps; the feature maps are the inner dimension and the images are the outermost dimension.

CUDNN_TENSOR_NCHW_VECT_C

This tensor format specifies that the data is laid out in the following order: batch size, feature maps, rows, columns. However, each element of the tensor is a vector of multiple feature maps. The length of the vector is carried by the data type of the tensor. The strides are implicitly defined in such a way that the data are contiguous in memory with no padding between images, feature maps, rows, and columns; the columns are the inner dimension and the images are the outermost dimension. This format is only supported with tensor data types CUDNN_DATA_INT8x4, CUDNN_DATA_INT8x32, and CUDNN_DATA_UINT8x4.

The CUDNN_TENSOR_NCHW_VECT_C can also be interpreted in the following way: The NCHW INT8x32 format is really $N \times (C/32) \times H \times W \times 32$ (32 Cs for every W), just as the NCHW INT8x4 format is $N \times (C/4) \times H \times W \times 4$ (4 Cs for every W). Hence, the VECT_C name - each W is a vector (4 or 32) of Cs.

3.2. API Functions

3.2.1. cudnnActivationForward()

```

cudnnStatus_t cudnnActivationForward(
    cudnnHandle_t handle,
    cudnnActivationDescriptor_t activationDesc,
    const void *alpha,
    const cudnnTensorDescriptor_t xDesc,
    const void *x,
    const void *beta,
    const cudnnTensorDescriptor_t yDesc,
    void *y)
    
```

This routine applies a specified neuron activation function element-wise over each input value.



Note:

- ▶ In-place operation is allowed for this routine; meaning, `xData` and `yData` pointers may be equal. However, this requires `xDesc` and `yDesc` descriptors to be identical (particularly, the strides of the input and output must match for an in-place operation to be allowed).
- ▶ All tensor formats are supported for 4 and 5 dimensions, however, the best performance is obtained when the strides of `xDesc` and `yDesc` are equal and HW-packed. For more than 5 dimensions the tensors must have their spatial dimensions packed.

Parameters

handle

Input. Handle to a previously created cuDNN context. For more information, see [cudnnHandle_t](#).

activationDesc

Input. Activation descriptor. For more information, see [cudnnActivationDescriptor_t](#).

alpha, beta

Input. Pointers to scaling factors (in host memory) used to blend the computation result with prior value in the output layer as follows:

```
dstValue = alpha[0]*result + beta[0]*priorDstValue
```

For more information, see [Scaling Parameters](#) in the *cuDNN Developer Guide*.

xDesc

Input. Handle to the previously initialized input tensor descriptor. For more information, see [cudnnTensorDescriptor_t](#).

x

Input. Data pointer to GPU memory associated with the tensor descriptor `xDesc`.

yDesc

Input. Handle to the previously initialized output tensor descriptor.

y

Output. Data pointer to GPU memory associated with the output tensor descriptor `yDesc`.

Returns

CUDNN_STATUS_SUCCESS

The function launched successfully.

CUDNN_STATUS_NOT_SUPPORTED

The function does not support the provided configuration.

CUDNN_STATUS_BAD_PARAM

At least one of the following conditions are met:

- ▶ The parameter `mode` has an invalid enumerant value.
- ▶ The dimensions `n`, `c`, `h`, `w` of the input tensor and output tensor differ.

- ▶ The datatype of the input tensor and output tensor differs.
- ▶ The strides `nStride`, `cStride`, `hStride`, `wStride` of the input tensor and output tensor differ and in-place operation is used (meaning, `x` and `y` pointers are equal).

CUDNN_STATUS_EXECUTION_FAILED

The function failed to launch on the GPU.

3.2.2. cudnnAddTensor ()

```

cudaStatus_t cudnnAddTensor(
    cudnnHandle_t          handle,
    const void             *alpha,
    const cudnnTensorDescriptor_t aDesc,
    const void             *A,
    const void             *beta,
    const cudnnTensorDescriptor_t cDesc,
    void                  *C)
    
```

This function adds the scaled values of a bias tensor to another tensor. Each dimension of the bias tensor `A` must match the corresponding dimension of the destination tensor `C` or must be equal to 1. In the latter case, the same value from the bias tensor for those dimensions will be used to blend into the `C` tensor.

 **Note:** Up to dimension 5, all tensor formats are supported. Beyond those dimensions, this routine is not supported

Parameters

handle

Input. Handle to a previously created cuDNN context. For more information, see [cudnnHandle_t](#).

alpha, beta

Input. Pointers to scaling factors (in host memory) used to blend the source value with the prior value in the destination tensor as follows:

$$dstValue = alpha[0]*srcValue + beta[0]*priorDstValue$$

For more information, see [Scaling Parameters](#) in the *cuDNN Developer Guide*.

aDesc

Input. Handle to a previously initialized tensor descriptor. For more information, see [cudnnTensorDescriptor_t](#).

A

Input. Pointer to data of the tensor described by the `aDesc` descriptor.

cDesc

Input. Handle to a previously initialized tensor descriptor.

C

Input/Output. Pointer to data of the tensor described by the `cDesc` descriptor.

Returns

CUDNN_STATUS_SUCCESS

The function executed successfully.

CUDNN_STATUS_NOT_SUPPORTED

The function does not support the provided configuration.

CUDNN_STATUS_BAD_PARAM

The dimensions of the bias tensor refer to an amount of data that is incompatible with the output tensor dimensions or the `dataType` of the two tensor descriptors are different.

CUDNN_STATUS_EXECUTION_FAILED

The function failed to launch on the GPU.

3.2.3. cudnnBatchNormalizationForwardInference()

```

cudnnStatus_t cudnnBatchNormalizationForwardInference(
    cudnnHandle_t          handle,
    cudnnBatchNormMode_t  mode,
    const void             *alpha,
    const void             *beta,
    const cudnnTensorDescriptor_t xDesc,
    const void             *x,
    const cudnnTensorDescriptor_t yDesc,
    void                   *y,
    const cudnnTensorDescriptor_t bnScaleBiasMeanVarDesc,
    const void             *bnScale,
    const void             *bnBias,
    const void             *estimatedMean,
    const void             *estimatedVariance,
    double                 epsilon)
    
```

This function performs the forward batch normalization layer computation for the inference phase. This layer is based on the paper [Batch Normalization: Accelerating Deep Network Training by Reducing Internal Covariate Shift](#), S. Ioffe, C. Szegedy, 2015.

Note:

- ▶ Only 4D and 5D tensors are supported.
- ▶ The input transformation performed by this function is defined as:

$$y = \beta * y + \alpha * [\beta_{scale} * (x - \text{estimatedMean}) / \sqrt{\epsilon + \text{estimatedVariance}}]$$
- ▶ The `epsilon` value has to be the same during training, backpropagation and inference.
- ▶ For the training phase, use [cudnnBatchNormalizationForwardTraining\(\)](#).
- ▶ Higher performance can be obtained when HW-packed tensors are used for all of `x` and `dx`.

For more information, see [cudnnDeriveBNTensorDescriptor\(\)](#) for the secondary tensor descriptor generation for the parameters used in this function.

Parameters

handle

Input. Handle to a previously created cuDNN library descriptor. For more information, see [cudaHandle_t](#).

mode

Input. Mode of operation (spatial or per-activation). For more information, see [cudaBatchNormMode_t](#).

alpha, beta

Inputs. Pointers to scaling factors (in host memory) used to blend the layer output value with prior value in the destination tensor as follows:

```
dstValue = alpha[0]*resultValue + beta[0]*priorDstValue
```

For more information, see [Scaling Parameters](#) in the *cuDNN Developer Guide*.

xDesc, yDesc

Input. Handles to the previously initialized tensor descriptors.

*x

Input. Data pointer to GPU memory associated with the tensor descriptor `xDesc`, for the layer's `x` input data.

*y

Input. Data pointer to GPU memory associated with the tensor descriptor `yDesc`, for the `y` output of the batch normalization layer.

bnScaleBiasMeanVarDesc, bnScale, bnBias

Inputs. Tensor descriptors and pointers in device memory for the batch normalization scale and bias parameters (in the [original paper](#) bias is referred to as beta and scale as gamma).

estimatedMean, estimatedVariance

Inputs. Mean and variance tensors (these have the same descriptor as the bias and scale). The `resultRunningMean` and `resultRunningVariance`, accumulated during the training phase from the [cudaBatchNormalizationForwardTraining\(\)](#) call, should be passed as inputs here.

epsilon

Input. Epsilon value used in the batch normalization formula. Its value should be equal to or greater than the value defined for `CUDNN_BN_MIN_EPSILON` in `cuda.h`.

Supported configurations

This function supports the following combinations of data types for various descriptors.

Table 7. Supported configurations

Data Type Configurations	xDesc	bnScaleBiasMean	alpha, beta	yDesc
INT8_CONFIG	CUDNN_DATA_INT8	CUDNN_DATA_FLOAT	CUDNN_DATA_FLOAT	CUDNN_DATA_INT8
PSEUDO_HALF_CONFIG	CUDNN_DATA_HALF	CUDNN_DATA_FLOAT	CUDNN_DATA_FLOAT	CUDNN_DATA_HALF
FLOAT_CONFIG	CUDNN_DATA_FLOAT	CUDNN_DATA_FLOAT	CUDNN_DATA_FLOAT	CUDNN_DATA_FLOAT
DOUBLE_CONFIG	CUDNN_DATA_DOUBLE	CUDNN_DATA_DOUBLE	CUDNN_DATA_DOUBLE	CUDNN_DATA_DOUBLE

Returns

CUDNN_STATUS_SUCCESS

The computation was performed successfully.

CUDNN_STATUS_NOT_SUPPORTED

The function does not support the provided configuration.

CUDNN_STATUS_BAD_PARAM

At least one of the following conditions are met:

- ▶ One of the pointers *alpha*, *beta*, *x*, *y*, *bnScale*, *bnBias*, *estimatedMean*, *estimatedInvVariance* is NULL.
- ▶ The number of *xDesc* or *yDesc* tensor descriptor dimensions is not within the range of [4, 5] (only 4D and 5D tensors are supported.)
- ▶ *bnScaleBiasMeanVarDesc* dimensions are not 1xCx1x1 for 4D and 1xCx1x1x1 for 5D for spatial, and are not 1xCxHxW for 4D and 1xCxDxHxW for 5D for per-activation mode.
- ▶ *epsilon* value is less than CUDNN_BN_MIN_EPSILON.
- ▶ Dimensions or data types mismatch for *xDesc*, *yDesc*.

3.2.4. cudnnCopyAlgorithmDescriptor()

This function has been deprecated in cuDNN 8.0.

3.2.5. cudnnCreate()

```
cudaStatus_t cudnnCreate(cudaHandle_t *handle)
```

This function initializes the cuDNN library and creates a handle to an opaque structure holding the cuDNN library context. It allocates hardware resources on the host and device and must be called prior to making any other cuDNN library calls.

The cuDNN library handle is tied to the current CUDA device (context). To use the library on multiple devices, one cuDNN handle needs to be created for each device.

For a given device, multiple cuDNN handles with different configurations (for example, different current CUDA streams) may be created. Because `cudnnCreate()` allocates some internal resources, the release of those resources by calling `cudnnDestroy()` will implicitly call

`cudaDeviceSynchronize`; therefore, the recommended best practice is to call `cudnnCreate/`
`cudnnDestroy` outside of performance-critical code paths.

For multithreaded applications that use the same device from different threads, the recommended programming model is to create one (or a few, as is convenient) cuDNN handle(s) per thread and use that cuDNN handle for the entire life of the thread.

Parameters

handle

Output. Pointer to pointer where to store the address to the allocated cuDNN handle. For more information, see [cudnnHandle_t](#).

Returns

CUDNN_STATUS_BAD_PARAM

Invalid (NULL) input pointer supplied.

CUDNN_STATUS_NOT_INITIALIZED

No compatible GPU found, CUDA driver not installed or disabled, CUDA runtime API initialization failed.

CUDNN_STATUS_ARCH_MISMATCH

NVIDIA GPU architecture is too old.

CUDNN_STATUS_ALLOC_FAILED

Host memory allocation failed.

CUDNN_STATUS_INTERNAL_ERROR

CUDA resource allocation failed.

CUDNN_STATUS_LICENSE_ERROR

cuDNN license validation failed (only when the feature is enabled).

CUDNN_STATUS_SUCCESS

cuDNN handle was created successfully.

3.2.6. cudnnCreateActivationDescriptor()

```

cudnnStatus_t cudnnCreateActivationDescriptor(
    cudnnActivationDescriptor_t *activationDesc)
    
```

This function creates an activation descriptor object by allocating the memory needed to hold its opaque structure. For more information, see [cudnnActivationDescriptor_t](#).

Returns

CUDNN_STATUS_SUCCESS

The object was created successfully.

CUDNN_STATUS_ALLOC_FAILED

The resources could not be allocated.

3.2.7. cudnnCreateAlgorithmDescriptor()

This function has been deprecated in cuDNN 8.0.

```
cudaStatus_t cudnnCreateAlgorithmDescriptor(
    cudaAlgorithmDescriptor_t *algoDesc)
```

This function creates an algorithm descriptor object by allocating the memory needed to hold its opaque structure.

Returns

CUDNN_STATUS_SUCCESS

The object was created successfully.

CUDNN_STATUS_ALLOC_FAILED

The resources could not be allocated.

3.2.8. cudnnCreateAlgorithmPerformance()

```
cudaStatus_t cudnnCreateAlgorithmPerformance(
    cudaAlgorithmPerformance_t *algoPerf,
    int numberToCreate)
```

This function creates multiple algorithm performance objects by allocating the memory needed to hold their opaque structures.

Returns

CUDNN_STATUS_SUCCESS

The object was created successfully.

CUDNN_STATUS_ALLOC_FAILED

The resources could not be allocated.

3.2.9. cudnnCreateDropoutDescriptor()

```
cudaStatus_t cudnnCreateDropoutDescriptor(
    cudaDropoutDescriptor_t *dropoutDesc)
```

This function creates a generic dropout descriptor object by allocating the memory needed to hold its opaque structure. For more information, see [cudaDropoutDescriptor_t](#).

Returns

CUDNN_STATUS_SUCCESS

The object was created successfully.

CUDNN_STATUS_ALLOC_FAILED

The resources could not be allocated.

3.2.10. cudnnCreateFilterDescriptor()

```
cudaStatus_t cudnnCreateFilterDescriptor(
    cudaFilterDescriptor_t *filterDesc)
```

This function creates a filter descriptor object by allocating the memory needed to hold its opaque structure. For more information, see [cudaFilterDescriptor_t](#).

Returns

CUDNN_STATUS_SUCCESS

The object was created successfully.

CUDNN_STATUS_ALLOC_FAILED

The resources could not be allocated.

3.2.11. cudnnCreateLRNDescriptor()

```
cudaStatus_t cudnnCreateLRNDescriptor(
    cudaLRNDescriptor_t *poolingDesc)
```

This function allocates the memory needed to hold the data needed for LRN and DivisiveNormalization layers operation and returns a descriptor used with subsequent layer forward and backward calls.

Returns

CUDNN_STATUS_SUCCESS

The object was created successfully.

CUDNN_STATUS_ALLOC_FAILED

The resources could not be allocated.

3.2.12. cudnnCreateOpTensorDescriptor()

```
cudaStatus_t cudnnCreateOpTensorDescriptor(
    cudaOpTensorDescriptor_t* opTensorDesc)
```

This function creates a tensor pointwise math descriptor. For more information, see [cudaOpTensorDescriptor_t](#).

Parameters

opTensorDesc

Output. Pointer to the structure holding the description of the tensor pointwise math such as add, multiply, and more.

Returns

CUDNN_STATUS_SUCCESS

The function returned successfully.

CUDNN_STATUS_BAD_PARAM

Tensor pointwise math descriptor passed to the function is invalid.

CUDNN_STATUS_ALLOC_FAILED

Memory allocation for this tensor pointwise math descriptor failed.

3.2.13. **cudaCreatePoolingDescriptor()**

```
cudaStatus_t cudaCreatePoolingDescriptor(
    cudaPoolingDescriptor_t *poolingDesc)
```

This function creates a pooling descriptor object by allocating the memory needed to hold its opaque structure.

Returns

CUDNN_STATUS_SUCCESS

The object was created successfully.

CUDNN_STATUS_ALLOC_FAILED

The resources could not be allocated.

3.2.14. **cudaCreateReduceTensorDescriptor()**

```
cudaStatus_t cudaCreateReduceTensorDescriptor(
    cudaReduceTensorDescriptor_t* reduceTensorDesc)
```

This function creates a reduced tensor descriptor object by allocating the memory needed to hold its opaque structure.

Returns

CUDNN_STATUS_SUCCESS

The object was created successfully.

CUDNN_STATUS_BAD_PARAM

reduceTensorDesc is a NULL pointer.

CUDNN_STATUS_ALLOC_FAILED

The resources could not be allocated.

3.2.15. **cudaCreateSpatialTransformerDescriptor()**

```
cudaStatus_t cudaCreateSpatialTransformerDescriptor(
    cudaSpatialTransformerDescriptor_t *stDesc)
```

This function creates a generic spatial transformer descriptor object by allocating the memory needed to hold its opaque structure.

Returns

CUDNN_STATUS_SUCCESS

The object was created successfully.

CUDNN_STATUS_ALLOC_FAILED

The resources could not be allocated.

3.2.16. **cudnnCreateTensorDescriptor()**

```

cudnnStatus_t cudnnCreateTensorDescriptor(
    cudnnTensorDescriptor_t *tensorDesc)

```

This function creates a generic tensor descriptor object by allocating the memory needed to hold its opaque structure. The data is initialized to all zeros.

Parameters

tensorDesc

Input. Pointer to pointer where the address to the allocated tensor descriptor object should be stored.

Returns

CUDNN_STATUS_BAD_PARAM

Invalid input argument.

CUDNN_STATUS_ALLOC_FAILED

The resources could not be allocated.

CUDNN_STATUS_SUCCESS

The object was created successfully.

3.2.17. **cudnnCreateTensorTransformDescriptor()**

```

cudnnStatus_t cudnnCreateTensorTransformDescriptor(
    cudnnTensorTransformDescriptor_t *transformDesc);

```

This function creates a tensor transform descriptor object by allocating the memory needed to hold its opaque structure. The tensor data is initialized to be all zero. Use the [cudnnSetTensorTransformDescriptor\(\)](#) function to initialize the descriptor created by this function.

Parameters

transformDesc

Output. A pointer to an uninitialized tensor transform descriptor.

Returns

CUDNN_STATUS_SUCCESS

The descriptor object was created successfully.

CUDNN_STATUS_BAD_PARAM

The transformDesc is NULL.

CUDNN_STATUS_ALLOC_FAILED

The memory allocation failed.

3.2.18. cudnnDeriveBNTensorDescriptor()

```

cudnnStatus_t cudnnDeriveBNTensorDescriptor(
    cudnnTensorDescriptor_t    derivedBnDesc,
    const cudnnTensorDescriptor_t xDesc,
    cudnnBatchNormMode_t      mode)
    
```

This function derives a secondary tensor descriptor for the batch normalization scale, invVariance, bnBias, and bnScale subtensors from the layer's x data descriptor.

Use the tensor descriptor produced by this function as the bnScaleBiasMeanVarDesc parameter for the [cudnnBatchNormalizationForwardInference\(\)](#) and [cudnnBatchNormalizationForwardTraining\(\)](#) functions, and as the bnScaleBiasDiffDesc parameter in the [cudnnBatchNormalizationBackward\(\)](#) function.

The resulting dimensions will be:

- ▶ 1xCx1x1 for 4D and 1xCx1x1x1 for 5D for BATCHNORM_MODE_SPATIAL
- ▶ 1xCxHxW for 4D and 1xCxDxHxW for 5D for BATCHNORM_MODE_PER_ACTIVATION mode

For HALF input data type the resulting tensor descriptor will have a FLOAT type. For other data types, it will have the same type as the input data.



Note:

- ▶ Only 4D and 5D tensors are supported.
- ▶ The derivedBnDesc should be first created using [cudnnCreateTensorDescriptor\(\)](#).
- ▶ xDesc is the descriptor for the layer's x data and has to be set up with proper dimensions prior to calling this function.

Parameters

derivedBnDesc

Output. Handle to a previously created tensor descriptor.

xDesc

Input. Handle to a previously created and initialized layer's x data descriptor.

mode

Input. Batch normalization layer mode of operation.

Returns

CUDNN_STATUS_SUCCESS

The computation was performed successfully.

CUDNN_STATUS_BAD_PARAM

Invalid Batch Normalization mode.

3.2.19. cudnnDeriveNormTensorDescriptor()

```

cudnnStatus_t CUDNNWINAPI
cudnnDeriveNormTensorDescriptor(cudnnTensorDescriptor_t derivedNormScaleBiasDesc,
                                cudnnTensorDescriptor_t derivedNormMeanVarDesc,
                                const cudnnTensorDescriptor_t xDesc,
                                cudnnNormMode_t mode,
                                int groupCnt)

```

This function derives tensor descriptors for the normalization mean, invariance, normBias, and normScale subtensors from the layer's x data descriptor and norm mode. normalization, mean, and invariance share the same descriptor while bias and scale share the same descriptor.

Use the tensor descriptor produced by this function as the normScaleBiasDesc or normMeanVarDesc parameter for the [cudnnNormalizationForwardInference\(\)](#) and [cudnnNormalizationForwardTraining\(\)](#) functions, and as the dNormScaleBiasDesc and normMeanVarDesc parameter in the [cudnnNormalizationBackward\(\)](#) function.

The resulting dimensions will be:

- ▶ 1xCx1x1 for 4D and 1xCx1x1x1 for 5D for CUDNN_NORM_PER_ACTIVATION
- ▶ 1xCxHxW for 4D and 1xCxDxHxW for 5D for CUDNN_NORM_PER_CHANNEL mode

For HALF input data type the resulting tensor descriptor will have a FLOAT type. For other data types, it will have the same type as the input data.

- ▶ Only 4D and 5D tensors are supported.
- ▶ The derivedNormScaleBiasDesc and derivedNormMeanVarDesc should be created first using [cudnnCreateTensorDescriptor\(\)](#).
- ▶ xDesc is the descriptor for the layer's x data and has to be set up with proper dimensions prior to calling this function.

Parameters

derivedNormScaleBiasDesc

Output. Handle to a previously created tensor descriptor.

derivedNormMeanVarDesc

Output. Handle to a previously created tensor descriptor.

xDesc

Input. Handle to a previously created and initialized layer's x data descriptor.

mode

Input. The normalization layer mode of operation.

Returns

CUDNN_STATUS_SUCCESS

The computation was performed successfully.

CUDNN_STATUS_BAD_PARAM

Invalid Batch Normalization mode.

3.2.20. **cudaDestroy()**

```
cudaStatus_t cudaDestroy(cudaHandle_t handle)
```

This function releases the resources used by the cuDNN handle. This function is usually the last call with a particular handle to the cuDNN handle. Because `cudaCreate()` allocates some internal resources, the release of those resources by calling `cudaDestroy()` will implicitly call `cudaDeviceSynchronize`; therefore, the recommended best practice is to call `cudaCreate/cudaDestroy` outside of performance-critical code paths.

Parameters

handle

Input. Pointer to the cuDNN handle to be destroyed.

Returns

CUDNN_STATUS_SUCCESS

The cuDNN context destruction was successful.

CUDNN_STATUS_BAD_PARAM

Invalid (NULL) pointer supplied.

3.2.21. **cudaDestroyActivationDescriptor()**

```
cudaStatus_t cudaDestroyActivationDescriptor(
    cudaActivationDescriptor_t activationDesc)
```

This function destroys a previously created activation descriptor object.

Returns

CUDNN_STATUS_SUCCESS

The object was destroyed successfully.

3.2.22. cudnnDestroyAlgorithmDescriptor()

This function has been deprecated in cuDNN 8.0.

```
cudaStatus_t cudnnDestroyAlgorithmDescriptor(
    cudnnActivationDescriptor_t algorithmDesc)
```

This function destroys a previously created algorithm descriptor object.

Returns

CUDNN_STATUS_SUCCESS

The object was destroyed successfully.

3.2.23. cudnnDestroyAlgorithmPerformance()

```
cudaStatus_t cudnnDestroyAlgorithmPerformance(
    cudnnAlgorithmPerformance_t algoPerf)
```

This function destroys a previously created algorithm descriptor object.

Returns

CUDNN_STATUS_SUCCESS

The object was destroyed successfully.

3.2.24. cudnnDestroyDropoutDescriptor()

```
cudaStatus_t cudnnDestroyDropoutDescriptor(
    cudnnDropoutDescriptor_t dropoutDesc)
```

This function destroys a previously created dropout descriptor object.

Returns

CUDNN_STATUS_SUCCESS

The object was destroyed successfully.

3.2.25. cudnnDestroyFilterDescriptor()

```
cudaStatus_t cudnnDestroyFilterDescriptor(
    cudnnFilterDescriptor_t filterDesc)
```

This function destroys a previously created tensor 4D descriptor object.

Returns

CUDNN_STATUS_SUCCESS

The object was destroyed successfully.

3.2.26. cudnnDestroyLRNDescriptor()

```
cudaStatus_t cudnnDestroyLRNDescriptor(
    cudnnLRNDescriptor_t lrnDesc)
```

This function destroys a previously created LRN descriptor object.

Returns

CUDNN_STATUS_SUCCESS

The object was destroyed successfully.

3.2.27. cudnnDestroyOpTensorDescriptor()

```
cudaStatus_t cudnnDestroyOpTensorDescriptor(
    cudnnOpTensorDescriptor_t opTensorDesc)
```

This function deletes a tensor pointwise math descriptor object.

Parameters

opTensorDesc

Input. Pointer to the structure holding the description of the tensor pointwise math to be deleted.

Returns

CUDNN_STATUS_SUCCESS

The function returned successfully.

3.2.28. cudnnDestroyPoolingDescriptor()

```
cudaStatus_t cudnnDestroyPoolingDescriptor(
    cudnnPoolingDescriptor_t poolingDesc)
```

This function destroys a previously created pooling descriptor object.

Returns

CUDNN_STATUS_SUCCESS

The object was destroyed successfully.

3.2.29. cudnnDestroyReduceTensorDescriptor()

```
cudaStatus_t cudnnDestroyReduceTensorDescriptor(
    cudnnReduceTensorDescriptor_t tensorDesc)
```

This function destroys a previously created reduce tensor descriptor object. When the input pointer is NULL, this function performs no destroy operation.

Parameters

tensorDesc

Input. Pointer to the reduce tensor descriptor object to be destroyed.

Returns

CUDNN_STATUS_SUCCESS

The object was destroyed successfully.

3.2.30. cudnnDestroySpatialTransformerDescriptor()

```
cudaStatus_t cudnnDestroySpatialTransformerDescriptor(
    cudaSpatialTransformerDescriptor_t stDesc)
```

This function destroys a previously created spatial transformer descriptor object.

Returns

CUDNN_STATUS_SUCCESS

The object was destroyed successfully.

3.2.31. cudnnDestroyTensorDescriptor()

```
cudaStatus_t cudnnDestroyTensorDescriptor(cudaTensorDescriptor_t tensorDesc)
```

This function destroys a previously created tensor descriptor object. When the input pointer is NULL, this function performs no destroy operation.

Parameters

tensorDesc

Input. Pointer to the tensor descriptor object to be destroyed.

Returns

CUDNN_STATUS_SUCCESS

The object was destroyed successfully.

3.2.32. cudnnDestroyTensorTransformDescriptor()

```
cudaStatus_t cudnnDestroyTensorTransformDescriptor(
    cudaTensorTransformDescriptor_t transformDesc);
```

Destroys a previously created tensor transform descriptor.

Parameters

transformDesc

Input. The tensor transform descriptor to be destroyed.

Returns

CUDNN_STATUS_SUCCESS

The descriptor was destroyed successfully.

3.2.33. cudnnDivisiveNormalizationForward()

```

cudnnStatus_t cudnnDivisiveNormalizationForward(
    cudnnHandle_t          handle,
    cudnnLRNDescriptor_t   normDesc,
    cudnnDivNormMode_t     mode,
    const void             *alpha,
    const cudnnTensorDescriptor_t xDesc,
    const void             *x,
    const void             *means,
    void                   *temp,
    void                   *temp2,
    const void             *beta,
    const cudnnTensorDescriptor_t yDesc,
    void                   *y)
    
```

This function performs the forward spatial `DivisiveNormalization` layer computation. It divides every value in a layer by the standard deviation of its spatial neighbors as described in [What is the Best Multi-Stage Architecture for Object Recognition, Jarrett 2009, Local Contrast Normalization Layer](#) section. Note that `DivisiveNormalization` only implements the $x/\max(c, \sigma_x)$ portion of the computation, where σ_x is the variance over the spatial neighborhood of x . The full LCN (Local Contrastive Normalization) computation can be implemented as a two-step process:

```

x_m = x - mean(x);
y = x_m / max(c, sigma(x_m));
    
```

The $x - \text{mean}(x)$ which is often referred to as "subtractive normalization" portion of the computation can be implemented using cuDNN average pooling layer followed by a call to `addTensor`.



Note: Supported tensor formats are NCHW for 4D and NCDHW for 5D with any non-overlapping non-negative strides. Only 4D and 5D tensors are supported.

Parameters

handle

Input. Handle to a previously created cuDNN library descriptor.

normDesc

Input. Handle to a previously initialized LRN parameter descriptor. This descriptor is used for both LRN and `DivisiveNormalization` layers.

divNormMode

Input. DivisiveNormalization layer mode of operation. Currently only CUDNN_DIVNORM_PRECOMPUTED_MEANS is implemented. Normalization is performed using the means input tensor that is expected to be precomputed by the user.

alpha, beta

Input. Pointers to scaling factors (in host memory) used to blend the layer output value with prior value in the destination tensor as follows:

```
dstValue = alpha[0]*resultValue + beta[0]*priorDstValue
```

For more information, see [Scaling Parameters](#) in the *cuDNN Developer Guide*.

xDesc, yDesc

Input. Tensor descriptor objects for the input and output tensors. Note that `xDesc` is shared between `x`, `means`, `temp`, and `temp2` tensors.

x

Input. Input tensor data pointer in device memory.

means

Input. Input means tensor data pointer in device memory. Note that this tensor can be `NULL` (in that case its values are assumed to be zero during the computation). This tensor also doesn't have to contain means, these can be any values, a frequently used variation is a result of convolution with a normalized positive kernel (such as Gaussian).

temp, temp2

Workspace. Temporary tensors in device memory. These are used for computing intermediate values during the forward pass. These tensors do not have to be preserved as inputs from forward to the backward pass. Both use `xDesc` as their descriptor.

y

Output. Pointer in device memory to a tensor for the result of the forward DivisiveNormalization computation.

Returns**CUDNN_STATUS_SUCCESS**

The computation was performed successfully.

CUDNN_STATUS_BAD_PARAM

At least one of the following conditions are met:

- ▶ One of the tensor pointers `x`, `y`, `temp`, `temp2` is `NULL`.
- ▶ Number of input tensor or output tensor dimensions is outside of `[4, 5]` range.
- ▶ A mismatch in dimensions between any two of the input or output tensors.
- ▶ For in-place computation when pointers `x == y`, a mismatch in strides between the input data and output data tensors.

- ▶ Alpha or beta pointer is NULL.
- ▶ LRN descriptor parameters are outside of their valid ranges.
- ▶ Any of the tensor strides are negative.

CUDNN_STATUS_UNSUPPORTED

The function does not support the provided configuration, for example, any of the input and output tensor strides mismatch (for the same dimension) is a non-supported configuration.

3.2.34. cudnnDropoutForward()

```

cudnnStatus_t cudnnDropoutForward(
    cudnnHandle_t          handle,
    const cudnnDropoutDescriptor_t dropoutDesc,
    const cudnnTensorDescriptor_t xdesc,
    const void             *x,
    const cudnnTensorDescriptor_t ydesc,
    void                  *y,
    void                  *reserveSpace,
    size_t                 reserveSpaceSizeInBytes)
    
```

This function performs forward dropout operation over *x* returning results in *y*. If *dropout* was used as a parameter to [cudnnSetDropoutDescriptor\(\)](#), the approximately *dropout* fraction of *x* values will be replaced by a 0, and the rest will be scaled by $1 / (1 - dropout)$. This function should not be running concurrently with another `cudnnDropoutForward()` function using the same states.

Note:

- ▶ Better performance is obtained for fully packed tensors.
- ▶ This function should not be called during inference.

Parameters

handle

Input. Handle to a previously created cuDNN context.

dropoutDesc

Input. Previously created dropout descriptor object.

xDesc

Input. Handle to a previously initialized tensor descriptor.

x

Input. Pointer to data of the tensor described by the `xDesc` descriptor.

yDesc

Input. Handle to a previously initialized tensor descriptor.

y

Output. Pointer to data of the tensor described by the `yDesc` descriptor.

reserveSpace

Output. Pointer to user-allocated GPU memory used by this function. It is expected that the contents of `reserveSpace` does not change between `cudaDropoutForward()` and `cudaDropoutBackward()` calls.

reserveSpaceSizeInBytes

Input. Specifies the size in bytes of the provided memory for the reserve space.

Returns

CUDNN_STATUS_SUCCESS

The call was successful.

CUDNN_STATUS_NOT_SUPPORTED

The function does not support the provided configuration.

CUDNN_STATUS_BAD_PARAM

At least one of the following conditions are met:

- ▶ The number of elements of input tensor and output tensors differ.
- ▶ The `datatype` of the input tensor and output tensors differs.
- ▶ The strides of the input tensor and output tensors differ and in-place operation is used (meaning, `x` and `y` pointers are equal).
- ▶ The provided `reserveSpaceSizeInBytes` is less than the value returned by `cudaDropoutGetReserveSpaceSize()`.
- ▶ `cudaSetDropoutDescriptor()` has not been called on `dropoutDesc` with the non-NULL `states` argument.

CUDNN_STATUS_EXECUTION_FAILED

The function failed to launch on the GPU.

3.2.35. `cudaDropoutGetReserveSpaceSize()`

```

cudaStatus_t cudaDropoutGetReserveSpaceSize(
    cudaTensorDescriptor_t  xDesc,
    size_t                  *sizeInBytes)
    
```

This function is used to query the amount of reserve needed to run dropout with the input dimensions given by `xDesc`. The same reserve space is expected to be passed to `cudaDropoutForward()` and `cudaDropoutBackward()`, and its contents is expected to remain unchanged between `cudaDropoutForward()` and `cudaDropoutBackward()` calls.

Parameters

xDesc

Input. Handle to a previously initialized tensor descriptor, describing input to a dropout operation.

sizeInBytes

Output. Amount of GPU memory needed as reserve space to be able to run dropout with an input tensor descriptor specified by xDesc.

Returns

CUDNN_STATUS_SUCCESS

The query was successful.

3.2.36. cudnnDropoutGetStatesSize()

```

cudnnStatus_t cudnnDropoutGetStatesSize(
    cudnnHandle_t    handle,
    size_t           *sizeInBytes)
    
```

This function is used to query the amount of space required to store the states of the random number generators used by [cudnnDropoutForward\(\)](#) function.

Parameters

handle

Input. Handle to a previously created cuDNN context.

sizeInBytes

Output. Amount of GPU memory needed to store random generator states.

Returns

CUDNN_STATUS_SUCCESS

The query was successful.

3.2.37. cudnnGetActivationDescriptor()

```

cudnnStatus_t cudnnGetActivationDescriptor(
    const cudnnActivationDescriptor_t  activationDesc,
    cudnnActivationMode_t              *mode,
    cudnnNanPropagation_t              *reluNanOpt,
    double                              *coef)
    
```

This function queries a previously initialized generic activation descriptor object.

Parameters

activationDesc

Input. Handle to a previously created activation descriptor.

mode

Output. Enumerant to specify the activation mode.

reluNanOpt

Output. Enumerant to specify the Nan propagation mode.

coef

Output. Floating point number to specify the clipping threshold when the activation mode is set to CUDNN_ACTIVATION_CLIPPED_RELU or to specify the alpha coefficient when the activation mode is set to CUDNN_ACTIVATION_ELU.

Returns

CUDNN_STATUS_SUCCESS

The object was queried successfully.

3.2.38. cudnnGetActivationDescriptorSwishBeta()

```

cudnnStatus_t
cudnnGetActivationDescriptorSwishBeta(cudnnActivationDescriptor_t
activationDesc, double* swish_beta)
    
```

This function queries the current beta parameter set for SWISH activation.

Parameters

activationDesc

Input. Handle to a previously created activation descriptor.

swish_beta

Output. Pointer to a double value that will receive the currently configured SWISH beta parameter.

Returns

CUDNN_STATUS_SUCCESS

The beta parameter was queried successfully.

CUDNN_STATUS_BAD_PARAM

At least one of activationDesc or swish_beta were NULL.

3.2.39. cudnnGetAlgorithmDescriptor()

This function has been deprecated in cuDNN 8.0.

```

cudnnStatus_t cudnnGetAlgorithmDescriptor(
    const cudnnAlgorithmDescriptor_t algoDesc,
    cudnnAlgorithm_t *algorithm)
    
```

This function queries a previously initialized generic algorithm descriptor object.

Parameters

algorithmDesc

Input. Handle to a previously created algorithm descriptor.

algorithm

Input. Struct to specify the algorithm.

Returns

CUDNN_STATUS_SUCCESS

The object was queried successfully.

3.2.40. cudnnGetAlgorithmPerformance ()

This function has been deprecated in cuDNN 8.0.

```

cudnnStatus_t cudnnGetAlgorithmPerformance (
    const cudnnAlgorithmPerformance_t  algoPerf,
    cudnnAlgorithmDescriptor_t*        algoDesc,
    cudnnStatus_t*                      status,
    float*                               time,
    size_t*                              memory)
    
```

This function queries a previously initialized generic algorithm performance object.

Parameters

algoPerf

Input/Output. Handle to a previously created algorithm performance object.

algoDesc

Output. The algorithm descriptor which the performance results describe.

status

Output. The cuDNN status returned from running the algoDesc algorithm.

timecoef

Output. The GPU time spent running the algoDesc algorithm.

memory

Output. The GPU memory needed to run the algoDesc algorithm.

Returns

CUDNN_STATUS_SUCCESS

The object was queried successfully.

3.2.41. cudnnGetAlgorithmSpaceSize()

This function has been deprecated in cuDNN 8.0.

```

cudnnStatus_t cudnnGetAlgorithmSpaceSize(
    cudnnHandle_t      handle,
    cudnnAlgorithmDescriptor_t algoDesc,
    size_t*            algoSpaceSizeInBytes)
    
```

This function queries for the amount of host memory needed to call [cudnnSaveAlgorithm\(\)](#), much like the “get workspace size” function query for the amount of device memory needed.

Parameters

handle

Input. Handle to a previously created cuDNN context.

algoDesc

Input. A previously created algorithm descriptor.

algoSpaceSizeInBytes

Output. Amount of host memory needed as a workspace to be able to save the metadata from the specified algoDesc.

Returns

CUDNN_STATUS_SUCCESS

The function launched successfully.

CUDNN_STATUS_BAD_PARAM

At least one of the arguments is NULL.

3.2.42. cudnnGetCallback()

```

cudnnStatus_t cudnnGetCallback(
    unsigned      mask,
    void          **udata,
    cudnnCallback_t fptr)
    
```

This function queries the internal states of cuDNN error reporting functionality.

Parameters

mask

Output. Pointer to the address where the current internal error reporting message bit mask will be outputted.

udata

Output. Pointer to the address where the current internally stored udata address will be stored.

fptr

Output. Pointer to the address where the current internally stored callback function pointer will be stored. When the built-in default callback function is used, NULL will be outputted.

Returns**CUDNN_STATUS_SUCCESS**

The function launched successfully.

CUDNN_STATUS_BAD_PARAM

If any of the input parameters are NULL.

3.2.43. cudnnGetCudartVersion()

```
size_t cudnnGetCudartVersion()
```

The same version of a given cuDNN library can be compiled against different NVIDIA® CUDA® Toolkit™ versions. This routine returns the CUDA Toolkit version that the currently used cuDNN library has been compiled against.

3.2.44. cudnnGetDropoutDescriptor()

```
cudaStatus_t cudnnGetDropoutDescriptor(
    cudnnDropoutDescriptor_t dropoutDesc,
    cudnnHandle_t handle,
    float *dropout,
    void **states,
    unsigned long long *seed)
```

This function queries the fields of a previously initialized dropout descriptor.

Parameters**dropoutDesc**

Input. Previously initialized dropout descriptor.

handle

Input. Handle to a previously created cuDNN context.

dropout

Output. The probability with which the value from input is set to 0 during the dropout layer.

states

Output. Pointer to user-allocated GPU memory that holds random number generator states.

seed

Output. Seed used to initialize random number generator states.

Returns

CUDNN_STATUS_SUCCESS

The call was successful.

CUDNN_STATUS_BAD_PARAM

One or more of the arguments was an invalid pointer.

3.2.45. **cudaGetErrorString()**

```
const char * cudaGetErrorString(cudaStatus_t status)
```

This function converts the cuDNN status code to a NULL terminated (ASCII) static string. For example, when the input argument is CUDNN_STATUS_SUCCESS, the returned string is CUDNN_STATUS_SUCCESS. When an invalid status value is passed to the function, the returned string is CUDNN_UNKNOWN_STATUS.

Parameters

status

Input. cuDNN enumerant status code.

Returns

Pointer to a static, NULL terminated string with the status name.

3.2.46. **cudaGetFilter4dDescriptor()**

```
cudaStatus_t cudaGetFilter4dDescriptor(
    const cudaFilterDescriptor_t filterDesc,
    cudaDataType_t *dataType,
    cudaTensorFormat_t *format,
    int *k,
    int *C,
    int *h,
    int *w)
```

This function queries the parameters of the previously initialized filter descriptor object.

Parameters

filterDesc

Input. Handle to a previously created filter descriptor.

dataType

Output. Data type.

format

Output. Type of format.

k

Output. Number of output feature maps.

c

Output. Number of input feature maps.

h

Output. Height of each filter.

w

Output. Width of each filter.

Returns

CUDNN_STATUS_SUCCESS

The object was set successfully.

3.2.47. cudnnGetFilterNdDescriptor()

```

cudnnStatus_t cudnnGetFilterNdDescriptor(
    const cudnnFilterDescriptor_t  wDesc,
    int                             nbDimsRequested,
    cudnnDataType_t                *dataType,
    cudnnTensorFormat_t           *format,
    int                             *nbDims,
    int                             filterDimA[])
    
```

This function queries a previously initialized filter descriptor object.

Parameters

wDesc

Input. Handle to a previously initialized filter descriptor.

nbDimsRequested

Input. Dimension of the expected filter descriptor. It is also the minimum size of the arrays `filterDimA` in order to be able to hold the results

dataType

Output. Data type.

format

Output. Type of format.

nbDims

Output. Actual dimension of the filter.

filterDimA

Output. Array of dimensions of at least `nbDimsRequested` that will be filled with the filter parameters from the provided filter descriptor.

Returns

CUDNN_STATUS_SUCCESS

The object was set successfully.

CUDNN_STATUS_BAD_PARAM

The parameter nbDimsRequested is negative.

3.2.48. cudnnGetFilterSizeInBytes ()

```

cudnnStatus_t
cudnnGetFilterSizeInBytes(const cudnnFilterDescriptor_t filterDesc, size_t *size) ;
    
```

This function returns the size of the filter tensor in memory with respect to the given descriptor. It can be used to know the amount of GPU memory to be allocated to hold that filter tensor.

Parameters

filterDesc

Input. handle to a previously initialized filter descriptor.

size

Output. size in bytes needed to hold the tensor in GPU memory.

Returns

CUDNN_STATUS_SUCCESS

filterDesc is valid.

CUDNN_STATUS_BAD_PARAM

filerDesc is invalid.

3.2.49. cudnnGetLRNDescriptor ()

```

cudnnStatus_t cudnnGetLRNDescriptor(
    cudnnLRNDescriptor_t normDesc,
    unsigned int *lrnN,
    double *lrnAlpha,
    double *lrnBeta,
    double *lrnK)
    
```

This function retrieves values stored in the previously initialized LRN descriptor object.

Parameters

normDesc

Output. Handle to a previously created LRN descriptor.

lrnN, lrnAlpha, lrnBeta, lrnK

Output. Pointers to receive values of parameters stored in the descriptor object. See [cudnnSetLRNDescriptor\(\)](#) for more details. Any of these pointers can be NULL (no value is returned for the corresponding parameter).

Returns

CUDNN_STATUS_SUCCESS

Function completed successfully.

3.2.50. **cudnnGetOpTensorDescriptor()**

```

cudnnStatus_t cudnnGetOpTensorDescriptor(
    const cudnnOpTensorDescriptor_t opTensorDesc,
    cudnnOpTensorOp_t *opTensorOp,
    cudnnDataType_t *opTensorCompType,
    cudnnNanPropagation_t *opTensorNanOpt)
    
```

This function returns the configuration of the passed tensor pointwise math descriptor.

Parameters

opTensorDesc

Input. Tensor pointwise math descriptor passed to get the configuration from.

opTensorOp

Output. Pointer to the tensor pointwise math operation type, associated with this tensor pointwise math descriptor.

opTensorCompType

Output. Pointer to the cuDNN data-type associated with this tensor pointwise math descriptor.

opTensorNanOpt

Output. Pointer to the NAN propagation option associated with this tensor pointwise math descriptor.

Returns

CUDNN_STATUS_SUCCESS

The function returned successfully.

CUDNN_STATUS_BAD_PARAM

Input tensor pointwise math descriptor passed is invalid.

3.2.51. **cudnnGetPooling2dDescriptor()**

```

cudnnStatus_t cudnnGetPooling2dDescriptor(
    const cudnnPoolingDescriptor_t poolingDesc,
    
```

```

    cudnnPoolingMode_t      *mode,
    cudnnNanPropagation_t  *maxpoolingNanOpt,
    int                     *windowHeight,
    int                     *windowWidth,
    int                     *verticalPadding,
    int                     *horizontalPadding,
    int                     *verticalStride,
    int                     *horizontalStride)

```

This function queries a previously created 2D pooling descriptor object.

Parameters

poolingDesc

Input. Handle to a previously created pooling descriptor.

mode

Output. Enumerant to specify the pooling mode.

maxpoolingNanOpt

Output. Enumerant to specify the Nan propagation mode.

windowHeight

Output. Height of the pooling window.

windowWidth

Output. Width of the pooling window.

verticalPadding

Output. Size of vertical padding.

horizontalPadding

Output. Size of horizontal padding.

verticalStride

Output. Pooling vertical stride.

horizontalStride

Output. Pooling horizontal stride.

Returns

CUDNN_STATUS_SUCCESS

The object was set successfully.

3.2.52. cudnnGetPooling2dForwardOutputDim()

```

cudnnStatus_t cudnnGetPooling2dForwardOutputDim(
    const cudnnPoolingDescriptor_t poolingDesc,
    const cudnnTensorDescriptor_t inputDesc,
    int *outN,
    int *outC,
    int *outH,

```

```
int *outW)
```

This function provides the output dimensions of a tensor after 2d pooling has been applied. Each dimension `h` and `w` of the output images is computed as follows:

```
outputDim = 1 + (inputDim + 2*padding - windowDim)/poolingStride;
```

Parameters

poolingDesc

Input. Handle to a previously initialized pooling descriptor.

inputDesc

Input. Handle to the previously initialized input tensor descriptor.

N

Output. Number of images in the output.

C

Output. Number of channels in the output.

H

Output. Height of images in the output.

W

Output. Width of images in the output.

Returns

CUDNN_STATUS_SUCCESS

The function launched successfully.

CUDNN_STATUS_BAD_PARAM

At least one of the following conditions are met:

- ▶ `poolingDesc` has not been initialized.
- ▶ `poolingDesc` or `inputDesc` has an invalid number of dimensions (2 and 4 respectively are required).

3.2.53. `cudaGetPoolingNdDescriptor()`

```
cudaStatus_t cudaGetPoolingNdDescriptor(
const cudaPoolingDescriptor_t poolingDesc,
int nbDimsRequested,
cudaPoolingMode_t *mode,
cudaNanPropagation_t *maxpoolingNanOpt,
int *nbDims,
int windowDimA[],
int paddingA[],
int strideA[])
```

This function queries a previously initialized generic pooling descriptor object.

Parameters

poolingDesc

Input. Handle to a previously created pooling descriptor.

nbDimsRequested

Input. Dimension of the expected pooling descriptor. It is also the minimum size of the arrays `windowDimA`, `paddingA`, and `strideA` in order to be able to hold the results.

mode

Output. Enumerant to specify the pooling mode.

maxpoolingNanOpt

Input. Enumerant to specify the Nan propagation mode.

nbDims

Output. Actual dimension of the pooling descriptor.

windowDimA

Output. Array of dimension of at least `nbDimsRequested` that will be filled with the window parameters from the provided pooling descriptor.

paddingA

Output. Array of dimension of at least `nbDimsRequested` that will be filled with the padding parameters from the provided pooling descriptor.

strideA

Output. Array of dimension at least `nbDimsRequested` that will be filled with the stride parameters from the provided pooling descriptor.

Returns

CUDNN_STATUS_SUCCESS

The object was queried successfully.

CUDNN_STATUS_NOT_SUPPORTED

The parameter `nbDimsRequested` is greater than `CUDNN_DIM_MAX`.

3.2.54. cudnnGetPoolingNdForwardOutputDim()

```
cudnnStatus_t cudnnGetPoolingNdForwardOutputDim(
    const cudnnPoolingDescriptor_t poolingDesc,
    const cudnnTensorDescriptor_t inputDesc,
    int nbDims,
    int outDimA[])
```

This function provides the output dimensions of a tensor after Nd pooling has been applied.

Each dimension of the $(nbDims-2)$ -D images of the output tensor is computed as follows:

```
outputDim = 1 + (inputDim + 2*padding - windowDim)/poolingStride;
```

Parameters

poolingDesc

Input. Handle to a previously initialized pooling descriptor.

inputDesc

Input. Handle to the previously initialized input tensor descriptor.

nbDims

Input. Number of dimensions in which pooling is to be applied.

outDimA

Output. Array of `nbDims` output dimensions.

Returns

CUDNN_STATUS_SUCCESS

The function launched successfully.

CUDNN_STATUS_BAD_PARAM

At least one of the following conditions are met:

- ▶ `poolingDesc` has not been initialized.
- ▶ The value of `nbDims` is inconsistent with the dimensionality of `poolingDesc` and `inputDesc`.

3.2.55. cudnnGetProperty()

```
cudaStatus_t cudnnGetProperty(
    cudaPropertyType type,
    int *value)
```

This function writes a specific part of the cuDNN library version number into the provided host storage.

Parameters

type

Input. Enumerant type that instructs the function to report the numerical value of the cuDNN major version, minor version, or the patch level.

value

Output. Host pointer where the version information should be written.

Returns

CUDNN_STATUS_INVALID_VALUE

Invalid value of the `type` argument.

CUDNN_STATUS_SUCCESS

Version information was stored successfully at the provided address.

3.2.56. **cudaGetReduceTensorDescriptor()**

```

cudaStatus_t cudaGetReduceTensorDescriptor(
    const cudaReduceTensorDescriptor_t reduceTensorDesc,
    cudaReduceTensorOp_t *reduceTensorOp,
    cudaDataType_t *reduceTensorCompType,
    cudaNanPropagation_t *reduceTensorNanOpt,
    cudaReduceTensorIndices_t *reduceTensorIndices,
    cudaIndicesType_t *reduceTensorIndicesType)

```

This function queries a previously initialized reduce tensor descriptor object.

Parameters

reduceTensorDesc

Input. Pointer to a previously initialized reduce tensor descriptor object.

reduceTensorOp

Output. Enumerant to specify the reduce tensor operation.

reduceTensorCompType

Output. Enumerant to specify the computation datatype of the reduction.

reduceTensorNanOpt

Input. Enumerant to specify the Nan propagation mode.

reduceTensorIndices

Output. Enumerant to specify the reduced tensor indices.

reduceTensorIndicesType

Output. Enumerant to specify the reduce tensor indices type.

Returns

CUDNN_STATUS_SUCCESS

The object was queried successfully.

CUDNN_STATUS_BAD_PARAM

`reduceTensorDesc` is NULL.

3.2.57. `cudnnGetReductionIndicesSize()`

```

cudnnStatus_t cudnnGetReductionIndicesSize(
    cudnnHandle_t          handle,
    const cudnnReduceTensorDescriptor_t reduceDesc,
    const cudnnTensorDescriptor_t aDesc,
    const cudnnTensorDescriptor_t cDesc,
    size_t                 *sizeInBytes)

```

This is a helper function to return the minimum size of the index space to be passed to the reduction given the input and output tensors.

Parameters

handle

Input. Handle to a previously created cuDNN library descriptor.

reduceDesc

Input. Pointer to a previously initialized reduce tensor descriptor object.

aDesc

Input. Pointer to the input tensor descriptor.

cDesc

Input. Pointer to the output tensor descriptor.

sizeInBytes

Output. Minimum size of the index space to be passed to the reduction.

Returns

CUDNN_STATUS_SUCCESS

The index space size is returned successfully.

3.2.58. `cudnnGetReductionWorkspaceSize()`

```

cudnnStatus_t cudnnGetReductionWorkspaceSize(
    cudnnHandle_t          handle,
    const cudnnReduceTensorDescriptor_t reduceDesc,
    const cudnnTensorDescriptor_t aDesc,
    const cudnnTensorDescriptor_t cDesc,
    size_t                 *sizeInBytes)

```

This is a helper function to return the minimum size of the workspace to be passed to the reduction given the input and output tensors.

Parameters

handle

Input. Handle to a previously created cuDNN library descriptor.

reduceDesc

Input. Pointer to a previously initialized reduce tensor descriptor object.

aDesc

Input. Pointer to the input tensor descriptor.

cDesc

Input. Pointer to the output tensor descriptor.

sizeInBytes

Output. Minimum size of the index space to be passed to the reduction.

Returns

CUDNN_STATUS_SUCCESS

The workspace size is returned successfully.

3.2.59. cudnnGetStream()

```

cudnnStatus_t cudnnGetStream(
    cudnnHandle_t handle,
    cudaStream_t *streamId)

```

This function retrieves the user CUDA stream programmed in the cuDNN handle. When the user's CUDA stream is not set in the cuDNN handle, this function reports the null-stream.

Parameters

handle

Input. Pointer to the cuDNN handle.

streamID

Output. Pointer where the current CUDA stream from the cuDNN handle should be stored.

Returns

CUDNN_STATUS_BAD_PARAM

Invalid (NULL) handle.

CUDNN_STATUS_SUCCESS

The stream identifier was retrieved successfully.

3.2.60. cudnnGetTensor4dDescriptor()

```

cudnnStatus_t cudnnGetTensor4dDescriptor(
    const cudnnTensorDescriptor_t tensorDesc,
    cudnnDataType_t *dataType,
    int *n,
    int *c,
    int *h,

```

```
int          *w,
int          *nStride,
int          *cStride,
int          *hStride,
int          *wStride)
```

This function queries the parameters of the previously initialized tensor4D descriptor object.

Parameters

tensorDesc

Input. Handle to a previously initialized tensor descriptor.

datatype

Output. Data type.

n

Output. Number of images.

c

Output. Number of feature maps per image.

h

Output. Height of each feature map.

w

Output. Width of each feature map.

nStride

Output. Stride between two consecutive images.

cStride

Output. Stride between two consecutive feature maps.

hStride

Output. Stride between two consecutive rows.

wStride

Output. Stride between two consecutive columns.

Returns

CUDNN_STATUS_SUCCESS

The operation succeeded.

3.2.61. cudnnGetTensorNdDescriptor()

```
cudaStatus_t cudnnGetTensorNdDescriptor(
    const cudnnTensorDescriptor_t  tensorDesc,
    int                             nbDimsRequested,
    cudaDataType_t                  *dataType,
    int                             *nbDims,
```

```
int dimA[],
int strideA[])
```

This function retrieves values stored in a previously initialized tensor descriptor object.

Parameters

tensorDesc

Input. Handle to a previously initialized tensor descriptor.

nbDimsRequested

Input. Number of dimensions to extract from a given tensor descriptor. It is also the minimum size of the arrays `dimA` and `strideA`. If this number is greater than the resulting `nbDims[0]`, only `nbDims[0]` dimensions will be returned.

datatype

Output. Data type.

nbDims

Output. Actual number of dimensions of the tensor will be returned in `nbDims[0]`.

dimA

Output. Array of dimensions of at least `nbDimsRequested` that will be filled with the dimensions from the provided tensor descriptor.

strideA

Output. Array of dimensions of at least `nbDimsRequested` that will be filled with the strides from the provided tensor descriptor.

Returns

CUDNN_STATUS_SUCCESS

The results were returned successfully.

CUDNN_STATUS_BAD_PARAM

Either `tensorDesc` or `nbDims` pointer is NULL.

3.2.62. cudnnGetTensorSizeInBytes()

```
cudaStatus_t cudnnGetTensorSizeInBytes(
    const cudaTensorDescriptor_t tensorDesc,
    size_t *size)
```

This function returns the size of the tensor in memory in respect to the given descriptor. This function can be used to know the amount of GPU memory to be allocated to hold that tensor.

Parameters

tensorDesc

Input. Handle to a previously initialized tensor descriptor.

size

Output. Size in bytes needed to hold the tensor in GPU memory.

Returns**CUDNN_STATUS_SUCCESS**

The results were returned successfully.

3.2.63. cudnnGetTensorTransformDescriptor()

```
cudnnStatus_t cudnnGetTensorTransformDescriptor(
    cudnnTensorTransformDescriptor_t transformDesc,
    uint32_t nbDimsRequested,
    cudnnTensorFormat_t *destFormat,
    int32_t padBeforeA[],
    int32_t padAfterA[],
    uint32_t foldA[],
    cudnnFoldingDirection_t *direction);
```

This function returns the values stored in a previously initialized tensor transform descriptor.

Parameters**transformDesc**

Input. A previously initialized tensor transform descriptor.

nbDimsRequested

Input. The number of dimensions to consider. For more information, see the [Tensor Descriptor](#) section in the *cuDNN Developer Guide*.

destFormat

Output. The transform format that will be returned.

padBeforeA[]

Output. An array filled with the amount of padding to add before each dimension. The dimension of this `padBeforeA[]` parameter is equal to `nbDimsRequested`.

padAfterA[]

Output. An array filled with the amount of padding to add after each dimension. The dimension of this `padBeforeA[]` parameter is equal to `nbDimsRequested`.

foldA[]

Output. An array that was filled with the folding parameters for each spatial dimension. The dimension of this `foldA[]` array is `nbDimsRequested-2`.

direction

Output. The setting that selects folding or unfolding. For more information, see [cudnnFoldingDirection_t](#).

Returns**CUDNN_STATUS_SUCCESS**

The results were obtained successfully.

CUDNN_STATUS_BAD_PARAM

If `transformDesc` is NULL or if `nbDimsRequested` is less than 3 or greater than `CUDNN_DIM_MAX`.

3.2.64. `cudnnGetVersion()`

```
size_t cudnnGetVersion()
```

This function returns the version number of the cuDNN library. It returns the `CUDNN_VERSION` defined present in the `cudnn.h` header file. Starting with release R2, the routine can be used to identify dynamically the current cuDNN library used by the application. The defined `CUDNN_VERSION` can be used to have the same application linked against different cuDNN versions using conditional compilation statements.

3.2.65. `cudnnInitTransformDest()`

```
cudnnStatus_t cudnnInitTransformDest(
    const cudnnTensorTransformDescriptor_t transformDesc,
    const cudnnTensorDescriptor_t srcDesc,
    cudnnTensorDescriptor_t destDesc,
    size_t *destSizeInBytes);
```

This function initializes and returns a destination tensor descriptor `destDesc` for tensor transform operations. The initialization is done with the desired parameters described in the transform descriptor `cudnnTensorDescriptor_t`.



Note: The returned tensor descriptor will be packed.

Parameters

transformDesc

Input. Handle to a previously initialized tensor transform descriptor.

srcDesc

Input. Handle to a previously initialized tensor descriptor.

destDesc

Output. Handle of the tensor descriptor that will be initialized and returned.

destSizeInBytes

Output. A pointer to hold the size, in bytes, of the new tensor.

Returns

CUDNN_STATUS_SUCCESS

The tensor descriptor was initialized successfully.

CUDNN_STATUS_BAD_PARAM

If either `srcDesc` or `destDesc` is NULL, or if the tensor descriptor's `nbDims` is incorrect. For more information, see the [Tensor Descriptor](#) section in the *cuDNN Developer Guide*.

CUDNN_STATUS_NOT_SUPPORTED

If the provided configuration is not 4D.

CUDNN_STATUS_EXECUTION_FAILED

Function failed to launch on the GPU.

3.2.66. cudnnLRNCrossChannelForward()

```

cudnnStatus_t cudnnLRNCrossChannelForward(
    cudnnHandle_t          handle,
    cudnnLRNDescriptor_t  normDesc,
    cudnnLRNMode_t        lrnMode,
    const void             *alpha,
    const cudnnTensorDescriptor_t xDesc,
    const void             *x,
    const void             *beta,
    const cudnnTensorDescriptor_t yDesc,
    void                   *y)
    
```

This function performs the forward LRN layer computation.

Note: Supported formats are: positive-strided, NCHW and NHWC for 4D *x* and *y*, and only NCDHW DHW-packed for 5D (for both *x* and *y*). Only non-overlapping 4D and 5D tensors are supported. NCHW layout is preferred for performance.

Parameters

handle

Input. Handle to a previously created cuDNN library descriptor.

normDesc

Input. Handle to a previously initialized LRN parameter descriptor.

lrnMode

Input. LRN layer mode of operation. Currently only CUDNN_LRN_CROSS_CHANNEL_DIM1 is implemented. Normalization is performed along the tensor's `dimA[1]`.

alpha, beta

Input. Pointers to scaling factors (in host memory) used to blend the layer output value with prior value in the destination tensor as follows:

$$dstValue = alpha[0]*resultValue + beta[0]*priorDstValue$$

For more information, see [Scaling Parameters](#) in the *cuDNN Developer Guide*.

xDesc, yDesc

Input. Tensor descriptor objects for the input and output tensors.

x

Input. Input tensor data pointer in device memory.

y

Output. Output tensor data pointer in device memory.

Returns

CUDNN_STATUS_SUCCESS

The computation was performed successfully.

CUDNN_STATUS_BAD_PARAM

At least one of the following conditions are met:

- ▶ One of the tensor pointers `x`, `y` is NULL.
- ▶ Number of input tensor dimensions is 2 or less.
- ▶ LRN descriptor parameters are outside of their valid ranges.
- ▶ One of the tensor parameters is 5D but is not in NCDHW DHW-packed format.

CUDNN_STATUS_NOT_SUPPORTED

The function does not support the provided configuration. See the following for some examples of non-supported configurations:

- ▶ Any of the input tensor datatypes is not the same as any of the output tensor datatype.
- ▶ `x` and `y` tensor dimensions mismatch.
- ▶ Any tensor parameters strides are negative.

3.2.67. cudnnNormalizationForwardInference ()

```

cudnnStatus_t
cudnnNormalizationForwardInference(cudnnHandle_t handle,
                                   cudnnNormMode_t mode,
                                   cudnnNormOps_t normOps,
                                   cudnnNormAlgo_t algo,
                                   const void *alpha,
                                   const void *beta,
                                   const cudnnTensorDescriptor_t xDesc,
                                   const void *x,
                                   const cudnnTensorDescriptor_t normScaleBiasDesc,
                                   const void *normScale,
                                   const void *normBias,
                                   const cudnnTensorDescriptor_t normMeanVarDesc,
                                   const void *estimatedMean,
                                   const void *estimatedVariance,
                                   const cudnnTensorDescriptor_t zDesc,
                                   const void *z,
                                   cudnnActivationDescriptor_t activationDesc,
                                   const cudnnTensorDescriptor_t yDesc,
                                   void *y,
                                   double epsilon,
                                   int groupCnt);

```

This function performs the forward normalization layer computation for the inference phase. Per-channel normalization layer is based on the paper [Batch Normalization: Accelerating Deep Network Training by Reducing Internal Covariate Shift](#), S. Ioffe, C. Szegedy, 2015.



Note:

- ▶ Only 4D and 5D tensors are supported.

- ▶ The input transformation performed by this function is defined as:

$$y = \text{beta} * y + \text{alpha} * [\text{normBias} + (\text{normScale} * (\text{x-estimatedMean}) / \sqrt{\text{epsilon} + \text{estimatedVariance}})]$$
- ▶ The `epsilon` value has to be the same during training, backpropagation, and inference.
- ▶ For the training phase, use [cudnnNormalizationForwardTraining\(\)](#).
- ▶ Higher performance can be obtained when HW-packed tensors are used for all of `x` and `y`.

Parameters

handle

Input. Handle to a previously created cuDNN library descriptor. For more information, see [cudnnHandle_t](#).

mode

Input. Mode of operation (per-channel or per-activation). For more information, see [cudnnNormMode_t](#).

normOps

Input. Mode of post-operative. Currently, `CUDNN_NORM_OPS_NORM_ACTIVATION` and `CUDNN_NORM_OPS_NORM_ADD_ACTIVATION` are not supported.

algo

Input. Algorithm to be performed. For more information, see [cudnnNormAlgo_t](#).

alpha, beta

Inputs. Pointers to scaling factors (in host memory) used to blend the layer output value with prior value in the destination tensor as follows:

```
dstValue = alpha[0]*resultValue + beta[0]*priorDstValue
```

For more information, see [Scaling Parameters](#) in the *cuDNN Developer Guide*.

xDesc, yDesc

Input. Handles to the previously initialized tensor descriptors.

*x

Input. Data pointer to GPU memory associated with the tensor descriptor `xDesc`, for the layer's `x` input data.

*y

Output. Data pointer to GPU memory associated with the tensor descriptor `yDesc`, for the `y` output of the normalization layer.

zDesc, *z

Input. Tensor descriptors and pointers in device memory for residual addition to the result of the normalization operation, prior to the activation. `zDesc` and `*z` are optional and are only used when `normOps` is `CUDNN_NORM_OPS_NORM_ADD_ACTIVATION`, otherwise users

may pass `NULL`. When in use, `z` should have exactly the same dimension as `x` and the final output `y`. For more information, see [cudaTensorDescriptor_t](#).

Since `normOps` is only supported for `CUDNN_NORM_OPS_NORM`, we can set these to `NULL` for now.

normScaleBiasDesc, normScale, normBias

Inputs. Tensor descriptors and pointers in device memory for the normalization scale and bias parameters (in the [original paper](#) bias is referred to as beta and scale as gamma).

normMeanVarDesc, estimatedMean, estimatedVariance

Inputs. Mean and variance tensors and their tensor descriptors. The `estimatedMean` and `estimatedVariance` inputs, accumulated during the training phase from the [cudaNormalizationForwardTraining\(\)](#) call, should be passed as inputs here.

activationDesc

Input. Descriptor for the activation operation. When the `normOps` input is set to either `CUDNN_NORM_OPS_NORM_ACTIVATION` or `CUDNN_NORM_OPS_NORM_ADD_ACTIVATION` then this activation is used, otherwise the user may pass `NULL`. Since `normOps` is only supported for `CUDNN_NORM_OPS_NORM`, we can set these to `NULL` for now.

epsilon

Input. Epsilon value used in the normalization formula. Its value should be equal to or greater than zero.

groutCnt

Input. Only support 1 for now.

Returns

CUDNN_STATUS_SUCCESS

The computation was performed successfully.

CUDNN_STATUS_NOT_SUPPORTED

The function does not support the provided configuration.

CUDNN_STATUS_BAD_PARAM

At least one of the following conditions are met:

- ▶ One of the pointers `alpha`, `beta`, `x`, `y`, `normScale`, `normBias`, `estimatedMean`, and `estimatedInvVariance` is `NULL`.
- ▶ The number of `xDesc` or `yDesc` tensor descriptor dimensions is not within the range of [4,5] (only 4D and 5D tensors are supported).
- ▶ `normScaleBiasDesc` and `normMeanVarDesc` dimensions are not 1xCx1x1 for 4D and 1xCx1x1x1 for 5D for per-channel, and are not 1xCxHxW for 4D and 1xCxDxHxW for 5D for per-activation mode.
- ▶ `epsilon` value is less than zero.

- ▶ Dimensions or data types mismatch for xDesc and yDesc.

CUDNN_STATUS_NOT_SUPPORTED

A compute or data type other than `FLOAT` was chosen, or an unknown algorithm type was chosen.

CUDNN_STATUS_EXECUTION_FAILED

The function failed to launch on the GPU.

3.2.68. `cudaOpsInferVersionCheck()`

```
cudaStatus_t cudaOpsInferVersionCheck(void)
```

This function is the first of a series of corresponding functions that check for consistent library versions among DLL files for different modules.

Returns

CUDNN_STATUS_SUCCESS

The version of this DLL file is consistent with cuDNN DLLs on which it depends.

CUDNN_STATUS_VERSION_MISMATCH

The version of this DLL file does not match that of a cuDNN DLLs on which it depends.

3.2.69. `cudaOpTensor()`

```
cudaStatus_t cudaOpTensor(
    cudaHandle_t          handle,
    const cudaOpTensorDescriptor_t opTensorDesc,
    const void           *alpha1,
    const cudaTensorDescriptor_t aDesc,
    const void           *A,
    const void           *alpha2,
    const cudaTensorDescriptor_t bDesc,
    const void           *B,
    const void           *beta,
    const cudaTensorDescriptor_t cDesc,
    void                 *C)
```

This function implements the equation $C = op(\alpha_1[0] * A, \alpha_2[0] * B) + \beta[0] * C$, given the tensors `A`, `B`, and `C` and the scaling factors `alpha1`, `alpha2`, and `beta`. The `op` to use is indicated by the descriptor `cudaOpTensorDescriptor_t`, meaning, the type of `opTensorDesc`. Currently-supported ops are listed by the `cudaOpTensorOp_t` enum.

The following restrictions on the input and destination tensors apply:

- ▶ Each dimension of the input tensor `A` must match the corresponding dimension of the destination tensor `C`, and each dimension of the input tensor `B` must match the corresponding dimension of the destination tensor `C` or must be equal to 1. In the latter case, the same value from the input tensor `B` for those dimensions will be used to blend into the `C` tensor.
- ▶ The data types of the input tensors `A` and `B`, and the destination tensor `C`, must satisfy [Table 8](#).

Table 8. Supported Datatypes

opTensorCompType in opTensorDesc	A	B	c (destination)
FLOAT	FLOAT	FLOAT	FLOAT
FLOAT	INT8	INT8	FLOAT
FLOAT	HALF	HALF	FLOAT
FLOAT	BFLOAT16	BFLOAT16	FLOAT
DOUBLE	DOUBLE	DOUBLE	DOUBLE
FLOAT	FLOAT	FLOAT	HALF
FLOAT	HALF	HALF	HALF
FLOAT	INT8	INT8	INT8
FLOAT	FLOAT	FLOAT	INT8
FLOAT	FLOAT	FLOAT	BFLOAT16
FLOAT	BFLOAT16	BFLOAT16	BFLOAT16

 **Note:** All tensor formats up to dimension five (5) are supported. This routine does not support tensor formats beyond these dimensions.

Parameters

handle

Input. Handle to a previously created cuDNN context.

opTensorDesc

Input. Handle to a previously initialized op tensor descriptor.

alpha1, alpha2, beta

Input. Pointers to scaling factors (in host memory) used to blend the source value with prior value in the destination tensor as follows:

$$dstValue = alpha[0]*resultValue + beta[0]*priorDstValue$$

For more information, see [Scaling Parameters](#) in the *cuDNN Developer Guide*.

aDesc, bDesc, cDesc

Input. Handle to a previously initialized tensor descriptor.

A, B

Input. Pointer to data of the tensors described by the aDesc and bDesc descriptors, respectively.

C

Input/Output. Pointer to data of the tensor described by the cDesc descriptor.

Returns

CUDNN_STATUS_SUCCESS

The function executed successfully.

CUDNN_STATUS_NOT_SUPPORTED

The function does not support the provided configuration. See the following for some examples of non-supported configurations:

- ▶ The dimensions of the bias tensor and the output tensor dimensions are above 5.
- ▶ `opTensorCompType` is not set as stated above.

CUDNN_STATUS_BAD_PARAM

The data type of the destination tensor `c` is unrecognized, or the restrictions on the input and destination tensors, stated above, are not met.

CUDNN_STATUS_EXECUTION_FAILED

The function failed to launch on the GPU.

3.2.70. cudnnPoolingForward()

```

cudnnStatus_t cudnnPoolingForward(
    cudnnHandle_t          handle,
    const cudnnPoolingDescriptor_t poolingDesc,
    const void             *alpha,
    const cudnnTensorDescriptor_t xDesc,
    const void             *x,
    const void             *beta,
    const cudnnTensorDescriptor_t yDesc,
    void                  *y)
    
```

This function computes pooling of input values (meaning, the maximum or average of several adjacent values) to produce an output with smaller height and/or width.



Note:

- ▶ All tensor formats are supported, best performance is expected when using HW-packed tensors. Only 2 and 3 spatial dimensions are allowed.
- ▶ The dimensions of the output tensor `yDesc` can be smaller or bigger than the dimensions advised by the routine [cudnnGetPooling2dForwardOutputDim\(\)](#) or [cudnnGetPoolingNdForwardOutputDim\(\)](#).
- ▶ For average pooling, the compute type is `float` even for integer input and output data type. Output round is nearest-even and clamp to most negative or most positive value of type if out of range.

Parameters

handle

Input. Handle to a previously created cuDNN context.

poolingDesc

Input. Handle to a previously initialized pooling descriptor.

alpha, beta

Input. Pointers to scaling factors (in host memory) used to blend the computation result with prior value in the output layer as follows:

```
dstValue = alpha[0]*resultValue + beta[0]*priorDstValue
```

For more information, see [Scaling Parameters](#) in the *cuDNN Developer Guide*.

xDesc

Input. Handle to the previously initialized input tensor descriptor. Must be of type `FLOAT`, `DOUBLE`, `HALF` or `INT8`. For more information, see [cudnnDataType_t](#).

x

Input. Data pointer to GPU memory associated with the tensor descriptor `xDesc`.

yDesc

Input. Handle to the previously initialized output tensor descriptor. Must be of type `FLOAT`, `DOUBLE`, `HALF` or `INT8`. For more information, see [cudnnDataType_t](#).

y

Output. Data pointer to GPU memory associated with the output tensor descriptor `yDesc`.

Returns

CUDNN_STATUS_SUCCESS

The function launched successfully.

CUDNN_STATUS_BAD_PARAM

At least one of the following conditions are met:

- ▶ The dimensions `n`, `c` of the input tensor and output tensors differ.
- ▶ The `datatype` of the input tensor and output tensors differs.

CUDNN_STATUS_NOT_SUPPORTED

The function does not support the provided configuration.

CUDNN_STATUS_EXECUTION_FAILED

The function failed to launch on the GPU.

3.2.71. cudnnQueryRuntimeError()

```
cudnnStatus_t cudnnQueryRuntimeError(
    cudnnHandle_t      handle,
    cudnnStatus_t      *rstatus,
    cudnnErrQueryMode_t mode,
    cudnnRuntimeTag_t  *tag)
```

cuDNN library functions perform extensive input argument checking before launching GPU kernels. The last step is to verify that the GPU kernel actually started. When a kernel fails to start, `CUDNN_STATUS_EXECUTION_FAILED` is returned by the corresponding API call. Typically, after a GPU kernel starts, no runtime checks are performed by the kernel itself - numerical results are simply written to output buffers.

When the `CUDNN_BATCHNORM_SPATIAL_PERSISTENT` mode is selected in [`cudaBatchNormalizationForwardTraining\(\)`](#) or [`cudaBatchNormalizationBackward\(\)`](#), the algorithm may encounter numerical overflows where `CUDNN_BATCHNORM_SPATIAL` performs just fine albeit at a slower speed. The user can invoke `cudaQueryRuntimeError()` to make sure numerical overflows did not occur during the kernel execution. Those issues are reported by the kernel that performs computations.

`cudaQueryRuntimeError()` can be used in polling and blocking software control flows. There are two polling modes (`CUDNN_ERRQUERY_RAWCODE` and `CUDNN_ERRQUERY_NONBLOCKING`) and one blocking mode `CUDNN_ERRQUERY_BLOCKING`.

`CUDNN_ERRQUERY_RAWCODE` reads the error storage location regardless of the kernel completion status. The kernel might not even start and the error storage (allocated per cuDNN handle) might be used by an earlier call.

`CUDNN_ERRQUERY_NONBLOCKING` checks if all tasks in the user stream are completed. The `cudaQueryRuntimeError()` function will return immediately and report `CUDNN_STATUS_RUNTIME_IN_PROGRESS` in `rstatus` if some tasks in the user stream are pending. Otherwise, the function will copy the remote kernel error code to `rstatus`.

In the blocking mode (`CUDNN_ERRQUERY_BLOCKING`), the function waits for all tasks to drain in the user stream before reporting the remote kernel error code. The blocking flavor can be further adjusted by calling `cudaSetDeviceFlags` with the `cudaDeviceScheduleSpin`, `cudaDeviceScheduleYield`, or `cudaDeviceScheduleBlockingSync` flag.

`CUDNN_ERRQUERY_NONBLOCKING` and `CUDNN_ERRQUERY_BLOCKING` modes should not be used when the user stream is changed in the cuDNN handle, meaning, [`cudaSetStream\(\)`](#) is invoked between functions that report runtime kernel errors and the `cudaQueryRuntimeError()` function.

The remote error status reported in `rstatus` can be set to: `CUDNN_STATUS_SUCCESS`, `CUDNN_STATUS_RUNTIME_IN_PROGRESS`, or `CUDNN_STATUS_RUNTIME_FP_OVERFLOW`. The remote kernel error is automatically cleared by `cudaQueryRuntimeError()`.

 **Note:** The `cudaQueryRuntimeError()` function should be used in conjunction with [`cudaBatchNormalizationForwardTraining\(\)`](#) and [`cudaBatchNormalizationBackward\(\)`](#) when the `cudaBatchNormMode_t` argument is `CUDNN_BATCHNORM_SPATIAL_PERSISTENT`.

Parameters

handle

Input. Handle to a previously created cuDNN context.

rstatus

Output. Pointer to the user's error code storage.

mode

Input. Remote error query mode.

tag

Input/Output. Currently, this argument should be NULL.

Returns

CUDNN_STATUS_SUCCESS

No errors detected (rstatus holds a valid value).

CUDNN_STATUS_BAD_PARAM

Invalid input argument.

CUDNN_STATUS_INTERNAL_ERROR

A stream blocking synchronization or a non-blocking stream query failed.

CUDNN_STATUS_MAPPING_ERROR

The device cannot access zero-copy memory to report kernel errors.

3.2.72. cudnnReduceTensor ()

```

cudnnStatus_t cudnnReduceTensor(
    cudnnHandle_t          handle,
    const cudnnReduceTensorDescriptor_t reduceTensorDesc,
    void*                 *indices,
    size_t                 indicesSizeInBytes,
    void*                 *workspace,
    size_t                 workspaceSizeInBytes,
    const void*           *alpha,
    const cudnnTensorDescriptor_t aDesc,
    const void*           *A,
    const void*           *beta,
    const cudnnTensorDescriptor_t cDesc,
    void*                 *C)
    
```

This function reduces tensor A by implementing the equation $C = \alpha * \text{reduce op} (A) + \beta * C$, given tensors A and C and scaling factors alpha and beta. The reduction op to use is indicated by the descriptor reduceTensorDesc. Currently-supported ops are listed by the [cudnnReduceTensorOp_t](#) enum.

Each dimension of the output tensor c must match the corresponding dimension of the input tensor A or must be equal to 1. The dimensions equal to 1 indicate the dimensions of A to be reduced.

The implementation will generate indices for the min and max ops only, as indicated by the [cudnnReduceTensorIndices_t](#) enum of the reduceTensorDesc. Requesting indices for the other reduction ops results in an error. The data type of the indices is indicated by the [cudnnIndicesType_t](#) enum; currently only the 32-bit (unsigned int) type is supported.

The indices returned by the implementation are not absolute indices but relative to the dimensions being reduced. The indices are also flattened, meaning, not coordinate tuples.

The data types of the tensors `A` and `C` must match if of type `double`. In this case, `alpha` and `beta` and the computation enum of `reduceTensorDesc` are all assumed to be of type `double`.

The `HALF` and `INT8` data types may be mixed with the `FLOAT` data types. In these cases, the computation enum of `reduceTensorDesc` is required to be of type `FLOAT`.



Note:

Up to dimension 8, all tensor formats are supported. Beyond those dimensions, this routine is not supported.

Parameters

handle

Input. Handle to a previously created cuDNN context.

reduceTensorDesc

Input. Handle to a previously initialized reduce tensor descriptor.

indices

Output. Handle to a previously allocated space for writing indices.

indicesSizeInBytes

Input. Size of the above previously allocated space.

workspace

Input. Handle to a previously allocated space for the reduction implementation.

workspaceSizeInBytes

Input. Size of the above previously allocated space.

alpha, beta

Input. Pointers to scaling factors (in host memory) used to blend the source value with prior value in the destination tensor as follows:

```
dstValue = alpha[0]*resultValue + beta[0]*priorDstValue
```

For more information, see [Scaling Parameters](#) in the *cuDNN Developer Guide*.

aDesc, cDesc

Input. Handle to a previously initialized tensor descriptor.

A

Input. Pointer to data of the tensor described by the `aDesc` descriptor.

C

Input/Output. Pointer to data of the tensor described by the `cDesc` descriptor.

Returns

CUDNN_STATUS_SUCCESS

The function executed successfully.

CUDNN_STATUS_NOT_SUPPORTED

The function does not support the provided configuration. See the following for some examples of non-supported configurations:

- ▶ The dimensions of the input tensor and the output tensor are above 8.
- ▶ `reduceTensorCompType` is not set as stated above.

CUDNN_STATUS_BAD_PARAM

The corresponding dimensions of the input and output tensors all match, or the conditions in the above paragraphs are unmet.

CUDNN_INVALID_VALUE

The allocations for the indices or workspace are insufficient.

CUDNN_STATUS_EXECUTION_FAILED

The function failed to launch on the GPU.

3.2.73. `cudaRestoreAlgorithm()`

This function has been deprecated in cuDNN 8.0.

```

cudaStatus_t cudaRestoreAlgorithm(
    cudaHandle_t      handle,
    void*             algoSpace,
    size_t            algoSpaceSizeInBytes,
    cudaAlgorithmDescriptor_t algoDesc)
    
```

This function reads algorithm metadata from the host memory space provided by the user in `algoSpace`, allowing the user to use the results of RNN finds from previous cuDNN sessions.

Parameters

handle

Input. Handle to a previously created cuDNN context.

algoDesc

Input. A previously created algorithm descriptor.

algoSpace

Input. Pointer to the host memory to be read.

algoSpaceSizeInBytes

Input. Amount of host memory needed as a workspace to be able to hold the metadata from the specified `algoDesc`.

Returns

CUDNN_STATUS_SUCCESS

The function launched successfully.

CUDNN_STATUS_NOT_SUPPORTED

The metadata is from a different cuDNN version.

CUDNN_STATUS_BAD_PARAM

At least one of the following conditions is met:

- ▶ One of the arguments is NULL.
- ▶ The metadata is corrupted.

3.2.74. cudnnRestoreDropoutDescriptor()

```

cudnnStatus_t cudnnRestoreDropoutDescriptor(
    cudnnDropoutDescriptor_t dropoutDesc,
    cudnnHandle_t             handle,
    float                     dropout,
    void                       *states,
    size_t                     stateSizeInBytes,
    unsigned long long        seed)
    
```

This function restores a dropout descriptor to a previously saved-off state.

Parameters

dropoutDesc

Input/Output. Previously created dropout descriptor.

handle

Input. Handle to a previously created cuDNN context.

dropout

Input. Probability with which the value from an input tensor is set to 0 when performing dropout.

states

Input. Pointer to GPU memory that holds random number generator states initialized by a prior call to [cudnnSetDropoutDescriptor\(\)](#).

stateSizeInBytes

Input. Size in bytes of buffer holding random number generator states.

seed

Input. Seed used in prior calls to [cudnnSetDropoutDescriptor\(\)](#) that initialized states buffer. Using a different seed from this has no effect. A change of seed, and

subsequent update to random number generator states can be achieved by calling [cudnnSetDropoutDescriptor\(\)](#).

Returns

CUDNN_STATUS_SUCCESS

The call was successful.

CUDNN_STATUS_INVALID_VALUE

States buffer size (as indicated in `stateSizeInBytes`) is too small.

3.2.75. `cudnnSaveAlgorithm()`

This function has been deprecated in cuDNN 8.0.

```

cudnnStatus_t cudnnSaveAlgorithm(
    cudnnHandle_t      handle,
    cudnnAlgorithmDescriptor_t algoDesc,
    void*              algoSpace
    size_t              algoSpaceSizeInBytes)
    
```

This function writes algorithm metadata into the host memory space provided by the user in `algoSpace`, allowing the user to preserve the results of RNN finds after cuDNN exits.

Parameters

handle

Input. Handle to a previously created cuDNN context.

algoDesc

Input. A previously created algorithm descriptor.

algoSpace

Input. Pointer to the host memory to be written.

algoSpaceSizeInBytes

Input. Amount of host memory needed as a workspace to be able to save the metadata from the specified `algoDesc`.

Returns

CUDNN_STATUS_SUCCESS

The function launched successfully.

CUDNN_STATUS_BAD_PARAM

At least one of the following conditions is met:

- ▶ One of the arguments is NULL.
- ▶ `algoSpaceSizeInBytes` is too small.

3.2.76. cudnnScaleTensor()

```

cudnnStatus_t cudnnScaleTensor(
    cudnnHandle_t      handle,
    const cudnnTensorDescriptor_t yDesc,
    void               *y,
    const void         *alpha)
    
```

This function scales all the elements of a tensor by a given factor.

Parameters

handle

Input. Handle to a previously created cuDNN context.

yDesc

Input. Handle to a previously initialized tensor descriptor.

y

Input/Output. Pointer to data of the tensor described by the yDesc descriptor.

alpha

Input. Pointer in the host memory to a single value that all elements of the tensor will be scaled with. For more information, see [Scaling Parameters](#) in the *cuDNN Developer Guide*.

Returns

CUDNN_STATUS_SUCCESS

The function launched successfully.

CUDNN_STATUS_NOT_SUPPORTED

The function does not support the provided configuration.

CUDNN_STATUS_BAD_PARAM

One of the provided pointers is nil.

CUDNN_STATUS_EXECUTION_FAILED

The function failed to launch on the GPU.

3.2.77. cudnnSetActivationDescriptor()

```

cudnnStatus_t cudnnSetActivationDescriptor(
    cudnnActivationDescriptor_t activationDesc,
    cudnnActivationMode_t      mode,
    cudnnNanPropagation_t      reluNanOpt,
    double                      coef)
    
```

This function initializes a previously created generic activation descriptor object.

Parameters

activationDesc

Input/Output. Handle to a previously created pooling descriptor.

mode

Input. Enumerant to specify the activation mode.

reluNanOpt

Input. Enumerant to specify the NaN propagation mode.

coef

Input. Floating point number. When the activation mode (see [cudnnActivationMode_t](#)) is set to CUDNN_ACTIVATION_CLIPPED_RELU, this input specifies the clipping threshold; and when the activation mode is set to CUDNN_ACTIVATION_RELU, this input specifies the upper bound.

Returns

CUDNN_STATUS_SUCCESS

The object was set successfully.

CUDNN_STATUS_BAD_PARAM

mode or reluNanOpt has an invalid enumerant value.

3.2.78. **cudnnSetActivationDescriptorSwishBeta()**

```
cudnnStatus_t cudnnSetActivationDescriptorSwishBeta(cudnnActivationDescriptor_t
activationDesc, double swish_beta)
```

This function sets the beta parameter of the SWISH activation function to `swish_beta`.

Parameters

activationDesc

Input/Output. Handle to a previously created activation descriptor.

swish_beta

Input. The value to set the SWISH activations' beta parameter to.

Returns

CUDNN_STATUS_SUCCESS

The value was set successfully.

CUDNN_STATUS_BAD_PARAM

The activation descriptor is a NULL pointer.

3.2.79. cudnnSetAlgorithmDescriptor()

This function has been deprecated in cuDNN 8.0.

```

cudnnStatus_t cudnnSetAlgorithmDescriptor(
    cudnnAlgorithmDescriptor_t    algorithmDesc,
    cudnnAlgorithm_t              algorithm)
    
```

This function initializes a previously created generic algorithm descriptor object.

Parameters

algorithmDesc

Input/Output. Handle to a previously created algorithm descriptor.

algorithm

Input. Struct to specify the algorithm.

Returns

CUDNN_STATUS_SUCCESS

The object was set successfully.

3.2.80. cudnnSetAlgorithmPerformance()

This function has been deprecated in cuDNN 8.0.

```

cudnnStatus_t cudnnSetAlgorithmPerformance(
    cudnnAlgorithmPerformance_t    algoPerf,
    cudnnAlgorithmDescriptor_t      algoDesc,
    cudnnStatus_t                  status,
    float                           time,
    size_t                          memory)
    
```

This function initializes a previously created generic algorithm performance object.

Parameters

algoPerf

Input/Output. Handle to a previously created algorithm performance object.

algoDesc

Input. The algorithm descriptor which the performance results describe.

status

Input. The cuDNN status returned from running the algoDesc algorithm.

time

Input. The GPU time spent running the algoDesc algorithm.

memory

Input. The GPU memory needed to run the algoDesc algorithm.

Returns**CUDNN_STATUS_SUCCESS**

The object was set successfully.

CUDNN_STATUS_BAD_PARAM

mode or reluNanOpt has an invalid enumerate value.

3.2.81. cudnnSetCallback()

```

cudnnStatus_t cudnnSetCallback(
    unsigned      mask,
    void          *udata,
    cudnnCallback_t  fptr)

```

This function sets the internal states of cuDNN error reporting functionality.

Parameters**mask**

Input. An unsigned integer. The four least significant bits (LSBs) of this unsigned integer are used for switching on and off the different levels of error reporting messages. This applies for both the default callbacks, and for the customized callbacks. The bit position is in correspondence with the enum of `cudnnSeverity_t`. The user may utilize the predefined macros `CUDNN_SEV_ERROR_EN`, `CUDNN_SEV_WARNING_EN`, and `CUDNN_SEV_INFO_EN` to form the bit mask. When a bit is set to 1, the corresponding message channel is enabled.

For example, when bit 3 is set to 1, the API logging is enabled. Currently, only the log output of level `CUDNN_SEV_INFO` is functional; the others are not yet implemented. When used for turning on and off the logging with the default callback, the user may pass `NULL` to `udata` and `fptr`. In addition, the environment variable `CUDNN_LOGDEST_DBG` must be set. For more information, see the [Backward compatibility and deprecation policy](#) section in the *cuDNN Developer Guide*.

- ▶ `CUDNN_SEV_INFO_EN= 0b1000` (functional).
- ▶ `CUDNN_SEV_ERROR_EN= 0b0010` (not yet functional).
- ▶ `CUDNN_SEV_WARNING_EN= 0b0100` (not yet functional).

The output of `CUDNN_SEV_FATAL` is always enabled and cannot be disabled.

udata

Input. A pointer provided by the user. This pointer will be passed to the user's custom logging callback function. The data it points to will not be read, nor be changed by cuDNN. This pointer may be used in many ways, such as in a mutex or in a communication socket for the user's callback function for logging. If the user is utilizing the default callback

function, or doesn't want to use this input in the customized callback function, they may pass in `NULL`.

fptr

Input. A pointer to a user-supplied callback function. When `NULL` is passed to this pointer, then cuDNN switches back to the built-in default callback function. The user-supplied callback function prototype must be similar to the following (also defined in the header file):

```
void customizedLoggingCallback (cudnnSeverity_t sev, void *udata, const
cudnnDebug_t *dbg, const char *msg);
```

- ▶ The structure `cudnnDebug_t` is defined in the header file. It provides the metadata, such as time, time since start, stream ID, process and thread ID, that the user may choose to print or store in their customized callback.
- ▶ The variable `msg` is the logging message generated by cuDNN. Each line of this message is terminated by `\0`, and the end of the message is terminated by `\0\0`. Users may select what is necessary to show in the log, and may reformat the string.

Returns

CUDNN_STATUS_SUCCESS

The function launched successfully.

3.2.82. cudnnSetDropoutDescriptor ()

```
cudnnStatus_t cudnnSetDropoutDescriptor (
cudnnDropoutDescriptor_t dropoutDesc,
cudnnHandle_t handle,
float dropout,
void *states,
size_t stateSizeInBytes,
unsigned long long seed)
```

This function initializes a previously created dropout descriptor object. If the `states` argument is equal to `NULL`, then the random number generator states won't be initialized, and only the `dropout` value will be set. The user is expected not to change the memory pointed at by `states` for the duration of the computation.

When the `states` argument is not `NULL`, a cuRAND initialization kernel is invoked by `cudnnSetDropoutDescriptor ()`. This kernel requires a substantial amount of GPU memory for the stack. Memory is released when the kernel finishes. The `CUDNN_STATUS_ALLOC_FAILED` status is returned when no sufficient free memory is available for the GPU stack.

Parameters

dropoutDesc

Input/Output. Previously created dropout descriptor object.

handle

Input. Handle to a previously created cuDNN context.

dropout

Input. The probability with which the value from input is set to zero during the dropout layer.

states

Output. Pointer to user-allocated GPU memory that will hold random number generator states.

stateSizeInBytes

Input. Specifies the size in bytes of the provided memory for the states.

seed

Input. Seed used to initialize random number generator states.

Returns**CUDNN_STATUS_SUCCESS**

The call was successful.

CUDNN_STATUS_INVALID_VALUE

The `stateSizeInBytes` argument is less than the value returned by [cudnnDropoutGetStatesSize\(\)](#).

CUDNN_STATUS_ALLOC_FAILED

The function failed to temporarily extend the GPU stack.

CUDNN_STATUS_EXECUTION_FAILED

The function failed to launch on the GPU.

CUDNN_STATUS_INTERNAL_ERROR

Internally used CUDA functions returned an error status.

3.2.83. cudnnSetFilter4dDescriptor()

```

cudnnStatus_t cudnnSetFilter4dDescriptor(
    cudnnFilterDescriptor_t  filterDesc,
    cudnnDataType_t         dataType,
    cudnnTensorFormat_t     format,
    int                      k,
    int                      c,
    int                      h,
    int                      w)

```

This function initializes a previously created filter descriptor object into a 4D filter. The layout of the filters must be contiguous in memory.

Tensor format `CUDNN_TENSOR_NHWC` has limited support in [cudnnConvolutionForward\(\)](#), [cudnnConvolutionBackwardData\(\)](#), and [cudnnConvolutionBackwardFilter\(\)](#).

Parameters

filterDesc

Input/Output. Handle to a previously created filter descriptor.

datatype

Input. Data type.

format

Input. Type of the filter layout format. If this input is set to CUDNN_TENSOR_NCHW, which is one of the enumerant values allowed by [cudaTensorFormat_t](#) descriptor, then the layout of the filter is in the form of κ CRS, where:

- ▶ κ represents the number of output feature maps
- ▶ c is the number of input feature maps
- ▶ R is the number of rows per filter
- ▶ s is the number of columns per filter

If this input is set to CUDNN_TENSOR_NHWC, then the layout of the filter is in the form of κ RSC. For more information, see [cudaTensorFormat_t](#).

k

Input. Number of output feature maps.

c

Input. Number of input feature maps.

h

Input. Height of each filter.

w

Input. Width of each filter.

Returns

CUDNN_STATUS_SUCCESS

The object was set successfully.

CUDNN_STATUS_BAD_PARAM

At least one of the parameters k , c , h , w is negative or `datatype` or `format` has an invalid enumerant value.

3.2.84. **cudaSetFilterNdDescriptor()**

```
cudaStatus_t cudaSetFilterNdDescriptor(
    cudaFilterDescriptor_t filterDesc,
    cudaDataType_t        dataType,
    cudaTensorFormat_t    format,
```

```
int          nbDims,
const int   filterDimA[])
```

This function initializes a previously created filter descriptor object. The layout of the filters must be contiguous in memory.

The tensor format CUDNN_TENSOR_NHWC has limited support in [cudnnConvolutionForward\(\)](#), [cudnnConvolutionBackwardData\(\)](#), and [cudnnConvolutionBackwardFilter\(\)](#).

Parameters

filterDesc

Input/Output. Handle to a previously created filter descriptor.

datatype

Input. Data type.

format

Input. Type of the filter layout format. If this input is set to CUDNN_TENSOR_NCHW, which is one of the enumerant values allowed by [cudnnTensorFormat_t](#) descriptor, then the layout of the filter is as follows:

- ▶ For N=4, a 4D filter descriptor, the filter layout is in the form of κCRS:
 - ▶ κ represents the number of output feature maps
 - ▶ c is the number of input feature maps
 - ▶ R is the number of rows per filter
 - ▶ s is the number of columns per filter
- ▶ For N=3, a 3D filter descriptor, the number s (number of columns per filter) is omitted.
- ▶ For N=5 and greater, the layout of the higher dimensions immediately follows RS.

On the other hand, if this input is set to CUDNN_TENSOR_NHWC, then the layout of the filter is as follows:

- ▶ For N=4, a 4D filter descriptor, the filter layout is in the form of κRSC.
- ▶ For N=3, a 3D filter descriptor, the number s (number of columns per filter) is omitted and the layout of c immediately follows R.
- ▶ For N=5 and greater, the layout of the higher dimensions are inserted between s and c. For more information, see [cudnnTensorFormat_t](#).

nbDims

Input. Dimension of the filter.

filterDimA

Input. Array of dimension nbDims containing the size of the filter for each dimension.

Returns

CUDNN_STATUS_SUCCESS

The object was set successfully.

CUDNN_STATUS_BAD_PARAM

At least one of the elements of the array filterDimA is negative or dataType or format has an invalid enumerant value.

CUDNN_STATUS_NOT_SUPPORTED

The parameter nbDims exceeds CUDNN_DIM_MAX.

3.2.85. cudnnSetLRNDescriptor()

```

cudnnStatus_t cudnnSetLRNDescriptor(
    cudnnLRNDescriptor_t  normDesc,
    unsigned               lrnN,
    double                 lrnAlpha,
    double                 lrnBeta,
    double                 lrnK)
    
```

This function initializes a previously created LRN descriptor object.



Note:

- ▶ Macros CUDNN_LRN_MIN_N, CUDNN_LRN_MAX_N, CUDNN_LRN_MIN_K, CUDNN_LRN_MIN_BETA defined in cudnn.h specify valid ranges for parameters.
- ▶ Values of double parameters will be cast down to the tensor datatype during computation.

Parameters

normDesc

Output. Handle to a previously created LRN descriptor.

lrnN

Input. Normalization window width in elements. The LRN layer uses a window [center-lookBehind, center+lookAhead], where lookBehind = floor((lrnN-1)/2), lookAhead = lrnN-lookBehind-1. So for n=10, the window is [k-4...k...k+5] with a total of 10 samples. For the DivisiveNormalization layer, the window has the same extents as above in all spatial dimensions (dimA[2], dimA[3], dimA[4]). By default, lrnN is set to 5 in [cudnnCreateLRNDescriptor\(\)](#).

lrnAlpha

Input. Value of the alpha variance scaling parameter in the normalization formula. Inside the library code, this value is divided by the window width for LRN and by (window width) ^ #spatialDimensions for DivisiveNormalization. By default, this value is set to 1e-4 in [cudnnCreateLRNDescriptor\(\)](#).

lrnBeta

Input. Value of the beta power parameter in the normalization formula. By default, this value is set to 0.75 in `cudaCreateLRNDescriptor()`.

lrnK

Input. Value of the k parameter in the normalization formula. By default, this value is set to 2.0.

Returns

CUDNN_STATUS_SUCCESS

The object was set successfully.

CUDNN_STATUS_BAD_PARAM

One of the input parameters was out of valid range as described above.

3.2.86. cudaSetOpTensorDescriptor()

```

cudaStatus_t cudaSetOpTensorDescriptor(
    cudaOpTensorDescriptor_t  opTensorDesc,
    cudaOpTensorOp_t         opTensorOp,
    cudaDataType_t           opTensorCompType,
    cudaNanPropagation_t     opTensorNanOpt)
    
```

This function initializes a tensor pointwise math descriptor.

Parameters

opTensorDesc

Output. Pointer to the structure holding the description of the tensor pointwise math descriptor.

opTensorOp

Input. Tensor pointwise math operation for this tensor pointwise math descriptor.

opTensorCompType

Input. Computation datatype for this tensor pointwise math descriptor.

opTensorNanOpt

Input. NAN propagation policy.

Returns

CUDNN_STATUS_SUCCESS

The function returned successfully.

CUDNN_STATUS_BAD_PARAM

At least one of the input parameters passed is invalid.

3.2.87. cudnnSetPooling2dDescriptor()

```

cudnnStatus_t cudnnSetPooling2dDescriptor(
    cudnnPoolingDescriptor_t poolingDesc,
    cudnnPoolingMode_t mode,
    cudnnNanPropagation_t maxpoolingNanOpt,
    int windowHeight,
    int windowWidth,
    int verticalPadding,
    int horizontalPadding,
    int verticalStride,
    int horizontalStride)

```

This function initializes a previously created generic pooling descriptor object into a 2D description.

Parameters

poolingDesc

Input/Output. Handle to a previously created pooling descriptor.

mode

Input. Enumerant to specify the pooling mode.

maxpoolingNanOpt

Input. Enumerant to specify the Nan propagation mode.

windowHeight

Input. Height of the pooling window.

windowWidth

Input. Width of the pooling window.

verticalPadding

Input. Size of vertical padding.

horizontalPadding

Input. Size of horizontal padding

verticalStride

Input. Pooling vertical stride.

horizontalStride

Input. Pooling horizontal stride.

Returns

CUDNN_STATUS_SUCCESS

The object was set successfully.

CUDNN_STATUS_BAD_PARAM

At least one of the parameters `windowHeight`, `windowWidth`, `verticalStride`, `horizontalStride` is negative or `mode` or `maxpoolingNanOpt` has an invalid enumerate value.

3.2.88. cudnnSetPoolingNdDescriptor()

```

cudnnStatus_t cudnnSetPoolingNdDescriptor(
    cudnnPoolingDescriptor_t poolingDesc,
    const cudnnPoolingMode_t mode,
    const cudnnNanPropagation_t maxpoolingNanOpt,
    int nbDims,
    const int windowDimA[],
    const int paddingA[],
    const int strideA[])
    
```

This function initializes a previously created generic pooling descriptor object.

Parameters

poolingDesc

Input/Output. Handle to a previously created pooling descriptor.

mode

Input. Enumerant to specify the pooling mode.

maxpoolingNanOpt

Input. Enumerant to specify the Nan propagation mode.

nbDims

Input. Dimension of the pooling operation. Must be greater than zero.

windowDimA

Input. Array of dimension `nbDims` containing the window size for each dimension. The value of array elements must be greater than zero.

paddingA

Input. Array of dimension `nbDims` containing the padding size for each dimension. Negative padding is allowed.

strideA

Input. Array of dimension `nbDims` containing the striding size for each dimension. The value of array elements must be greater than zero (meaning, negative striding size is not allowed).

Returns

CUDNN_STATUS_SUCCESS

The object was initialized successfully.

CUDNN_STATUS_NOT_SUPPORTED

If {nbDims > CUDNN_DIM_MAX-2}.

CUDNN_STATUS_BAD_PARAM

Either nbDims, or at least one of the elements of the arrays windowDimA or strideA is negative, or mode or maxpoolingNanOpt has an invalid enumerate value.

3.2.89. cudnnSetReduceTensorDescriptor()

```

cudnnStatus_t cudnnSetReduceTensorDescriptor(
    cudnnReduceTensorDescriptor_t    reduceTensorDesc,
    cudnnReduceTensorOp_t           reduceTensorOp,
    cudnnDataType_t                 reduceTensorCompType,
    cudnnNanPropagation_t           reduceTensorNanOpt,
    cudnnReduceTensorIndices_t      reduceTensorIndices,
    cudnnIndicesType_t              reduceTensorIndicesType)
    
```

This function initializes a previously created reduce tensor descriptor object.

Parameters

reduceTensorDesc

Input/Output. Handle to a previously created reduce tensor descriptor.

reduceTensorOp

Input. Enumerant to specify the reduce tensor operation.

reduceTensorCompType

Input. Enumerant to specify the computation datatype of the reduction.

reduceTensorNanOpt

Input. Enumerant to specify the Nan propagation mode.

reduceTensorIndices

Input. Enumerant to specify the reduced tensor indices.

reduceTensorIndicesType

Input. Enumerant to specify the reduce tensor indices type.

Returns

CUDNN_STATUS_SUCCESS

The object was set successfully.

CUDNN_STATUS_BAD_PARAM

reduceTensorDesc is NULL {reduceTensorOp, reduceTensorCompType, reduceTensorNanOpt, reduceTensorIndices or reduceTensorIndicesType has an invalid enumerant value}.

3.2.90. cudnnSetSpatialTransformerNdDescriptor()

```

cudnnStatus_t cudnnSetSpatialTransformerNdDescriptor(
    cudnnSpatialTransformerDescriptor_t    stDesc,
    cudnnSamplerType_t                    samplerType,
    cudnnDataType_t                        dataType,
    const int                               nbDims,
    const int                               dimA[])

```

This function initializes a previously created generic spatial transformer descriptor object.

Parameters

stDesc

Input/Output. Previously created spatial transformer descriptor object.

samplerType

Input. Enumerant to specify the sampler type.

dataType

Input. Data type.

nbDims

Input. Dimension of the transformed tensor.

dimA

Input. Array of dimension nbDims containing the size of the transformed tensor for every dimension.

Returns

CUDNN_STATUS_SUCCESS

The call was successful.

CUDNN_STATUS_BAD_PARAM

At least one of the following conditions are met:

- ▶ Either stDesc or dimA is NULL.
- ▶ Either dataType or samplerType has an invalid enumerant value

3.2.91. cudnnSetStream()

```

cudnnStatus_t cudnnSetStream(
    cudnnHandle_t    handle,
    cudaStream_t     streamId)

```

This function sets the user's CUDA stream in the cuDNN handle. The new stream will be used to launch cuDNN GPU kernels or to synchronize to this stream when cuDNN kernels are launched in the internal streams. If the cuDNN library stream is not set, all kernels use the default (NULL) stream. Setting the user stream in the cuDNN handle guarantees the issue-order execution of cuDNN calls and other GPU kernels launched in the same stream.

Parameters

handle

Input. Pointer to the cuDNN handle.

streamID

Input. New CUDA stream to be written to the cuDNN handle.

Returns

CUDNN_STATUS_BAD_PARAM

Invalid (NULL) handle.

CUDNN_STATUS_MAPPING_ERROR

Mismatch between the user stream and the cuDNN handle context.

CUDNN_STATUS_SUCCESS

The new stream was set successfully.

3.2.92. cudnnSetTensor()

```

cudnnStatus_t cudnnSetTensor(
    cudnnHandle_t          handle,
    const cudnnTensorDescriptor_t yDesc,
    void                   *y,
    const void             *valuePtr)

```

This function sets all the elements of a tensor to a given value.

Parameters

handle

Input. Handle to a previously created cuDNN context.

yDesc

Input. Handle to a previously initialized tensor descriptor.

y

Input/Output. Pointer to data of the tensor described by the yDesc descriptor.

valuePtr

Input. Pointer in host memory to a single value. All elements of the y tensor will be set to value[0]. The data type of the element in value[0] has to match the data type of tensor y.

Returns

CUDNN_STATUS_SUCCESS

The function launched successfully.

CUDNN_STATUS_NOT_SUPPORTED

The function does not support the provided configuration.

CUDNN_STATUS_BAD_PARAM

One of the provided pointers is nil.

CUDNN_STATUS_EXECUTION_FAILED

The function failed to launch on the GPU.

3.2.93. cudnnSetTensor4dDescriptor()

```

cudnnStatus_t cudnnSetTensor4dDescriptor(
    cudnnTensorDescriptor_t tensorDesc,
    cudnnTensorFormat_t     format,
    cudnnDataType_t         dataType,
    int                      n,
    int                      c,
    int                      h,
    int                      w)
    
```

This function initializes a previously created generic tensor descriptor object into a 4D tensor. The strides of the four dimensions are inferred from the format parameter and set in such a way that the data is contiguous in memory with no padding between dimensions.

 **Note:** The total size of a tensor including the potential padding between dimensions is limited to 2 Giga-elements of type `datatype`.

Parameters

tensorDesc

Input/Output. Handle to a previously created tensor descriptor.

format

Input. Type of format.

datatype

Input. Data type.

n

Input. Number of images.

c

Input. Number of feature maps per image.

h

Input. Height of each feature map.

w

Input. Width of each feature map.

Returns

CUDNN_STATUS_SUCCESS

The object was set successfully.

CUDNN_STATUS_BAD_PARAM

At least one of the parameters `n`, `c`, `h`, `w` was negative or `format` has an invalid enumerant value or `dataType` has an invalid enumerant value.

CUDNN_STATUS_NOT_SUPPORTED

The total size of the tensor descriptor exceeds the maximum limit of 2 Giga-elements.

3.2.94. cudnnSetTensor4dDescriptorEx()

```

cudnnStatus_t cudnnSetTensor4dDescriptorEx(
    cudnnTensorDescriptor_t  tensorDesc,
    cudnnDataType_t          dataType,
    int                      n,
    int                      c,
    int                      h,
    int                      w,
    int                      nStride,
    int                      cStride,
    int                      hStride,
    int                      wStride)
    
```

This function initializes a previously created generic tensor descriptor object into a 4D tensor, similarly to `cudnnSetTensor4dDescriptor()` but with the strides explicitly passed as parameters. This can be used to lay out the 4D tensor in any order or simply to define gaps between dimensions.

Note:

- ▶ At present, some cuDNN routines have limited support for strides. Those routines will return `CUDNN_STATUS_NOT_SUPPORTED` if a 4D tensor object with an unsupported stride is used. [cudnnTransformTensor\(\)](#) can be used to convert the data to a supported layout.
- ▶ The total size of a tensor including the potential padding between dimensions is limited to 2 Giga-elements of type `datatype`.

Parameters

tensorDesc

Input/Output. Handle to a previously created tensor descriptor.

datatype

Input. Data type.

n

Input. Number of images.

c

Input. Number of feature maps per image.

h

Input. Height of each feature map.

w

Input. Width of each feature map.

nStride

Input. Stride between two consecutive images.

cStride

Input. Stride between two consecutive feature maps.

hStride

Input. Stride between two consecutive rows.

wStride

Input. Stride between two consecutive columns.

Returns

CUDNN_STATUS_SUCCESS

The object was set successfully.

CUDNN_STATUS_BAD_PARAM

At least one of the parameters `n`, `c`, `h`, `w` or `nStride`, `cStride`, `hStride`, `wStride` is negative or `dataType` has an invalid enumerant value.

CUDNN_STATUS_NOT_SUPPORTED

The total size of the tensor descriptor exceeds the maximum limit of 2 Giga-elements.

3.2.95. `cudaSetTensorNdDescriptor()`

```

cudaStatus_t cudaSetTensorNdDescriptor(
    cudaTensorDescriptor_t tensorDesc,
    cudaDataType_t          dataType,
    int                     nbDims,
    const int               dimA[],
    const int               strideA[])

```

This function initializes a previously created generic tensor descriptor object.



Note: The total size of a tensor including the potential padding between dimensions is limited to 2 Giga-elements of type `dataType`. Tensors are restricted to having at least 4 dimensions, and at most `CUDNN_DIM_MAX` dimensions (defined in `cuda.h`). When working with lower dimensional data, it is recommended that the user create a 4D tensor, and set the size along unused dimensions to 1.

Parameters

tensorDesc

Input/Output. Handle to a previously created tensor descriptor.

datatype

Input. Data type.

nbDims

Input. Dimension of the tensor.

 **Note:** Do not use 2 dimensions. Due to historical reasons, the minimum number of dimensions in the filter descriptor is three. For more information, see [cudnnGetRNNLinLayerBiasParams\(\)](#).

dimA

Input. Array of dimension nbDims that contain the size of the tensor for every dimension. The size along unused dimensions should be set to 1. By convention, the ordering of dimensions in the array follows the format - [N, C, D, H, W], with W occupying the smallest index in the array.

strideA

Input. Array of dimension nbDims that contain the stride of the tensor for every dimension. By convention, the ordering of the strides in the array follows the format - [Nstride, Cstride, Dstride, Hstride, Wstride], with Wstride occupying the smallest index in the array.

Returns

CUDNN_STATUS_SUCCESS

The object was set successfully.

CUDNN_STATUS_BAD_PARAM

At least one of the elements of the array dimA was negative or zero, or dataType has an invalid enumerant value.

CUDNN_STATUS_NOT_SUPPORTED

The parameter nbDims is outside the range [4, CUDNN_DIM_MAX], or the total size of the tensor descriptor exceeds the maximum limit of 2 Giga-elements.

3.2.96. cudnnSetTensorNdDescriptorEx()

```

cudnnStatus_t cudnnSetTensorNdDescriptorEx(
    cudnnTensorDescriptor_t tensorDesc,
    cudnnTensorFormat_t     format,
    cudnnDataType_t         dataType,

```

```
int          nbDims,
const int    dimA[])
```

This function initializes an n-D tensor descriptor.

Parameters

tensorDesc

Output. Pointer to the tensor descriptor struct to be initialized.

format

Input. Tensor format.

dataType

Input. Tensor data type.

nbDims

Input. Dimension of the tensor.



Note: Do not use 2 dimensions. Due to historical reasons, the minimum number of dimensions in the filter descriptor is three. For more information, see [cudnnGetRNINLinLayerBiasParams\(\)](#).

dimA

Input. Array containing the size of each dimension.

Returns

CUDNN_STATUS_SUCCESS

The function was successful.

CUDNN_STATUS_BAD_PARAM

Tensor descriptor was not allocated properly; or input parameters are not set correctly.

CUDNN_STATUS_NOT_SUPPORTED

Dimension size requested is larger than maximum dimension size supported.

3.2.97. cudnnSetTensorTransformDescriptor()

```
cudnnStatus_t cudnnSetTensorTransformDescriptor(
    cudnnTensorTransformDescriptor_t transformDesc,
    const uint32_t nbDims,
    const cudnnTensorFormat_t destFormat,
    const int32_t padBeforeA[],
    const int32_t padAfterA[],
    const uint32_t foldA[],
    const cudnnFoldingDirection_t direction);
```

This function initializes a tensor transform descriptor that was previously created using the [cudnnCreateTensorTransformDescriptor\(\)](#) function.

Parameters

transformDesc

Output. The tensor transform descriptor to be initialized.

nbDims

Input. The dimensionality of the transform operands. Must be greater than 2. For more information, see the [Tensor Descriptor](#) section from the *cuDNN Developer Guide*.

destFormat

Input. The desired destination format.

padBeforeA[]

Input. An array that contains the amount of padding that should be added before each dimension. Set to `NULL` for no padding.

padAfterA[]

Input. An array that contains the amount of padding that should be added after each dimension. Set to `NULL` for no padding.

foldA[]

Input. An array that contains the folding parameters for each spatial dimension (dimensions 2 and up). Set to `NULL` for no folding.

direction

Input. Selects folding or unfolding. This input has no effect when folding parameters are all ≤ 1 . For more information, see [cudaFoldingDirection_t](#).

Returns

CUDNN_STATUS_SUCCESS

The function was launched successfully.

CUDNN_STATUS_BAD_PARAM

The parameter `transformDesc` is `NULL`, or if `direction` is invalid, or `nbDims` is ≤ 2 .

CUDNN_STATUS_NOT_SUPPORTED

If the dimension size requested is larger than maximum dimension size supported (meaning, one of the `nbDims` is larger than `CUDNN_DIM_MAX`), or if `destFormat` is something other than `NCHW` or `NHWC`.

3.2.98. `cudaSoftmaxForward()`

```

cudaStatus_t cudaSoftmaxForward(
    cudaHandle_t          handle,
    cudaSoftmaxAlgorithm_t algorithm,
    cudaSoftmaxMode_t     mode,
    const void            *alpha,

```

```

const cudnnTensorDescriptor_t  xDesc,
const void                    *x,
const void                    *beta,
const cudnnTensorDescriptor_t  yDesc,
void                          *y)

```

This routine computes the softmax function.



Note: All tensor formats are supported for all modes and algorithms with 4 and 5D tensors. Performance is expected to be highest with NCHW fully-packed tensors. For more than 5 dimensions tensors must be packed in their spatial dimensions

Parameters

handle

Input. Handle to a previously created cuDNN context.

algorithm

Input. Enumerant to specify the softmax algorithm.

mode

Input. Enumerant to specify the softmax mode.

alpha, beta

Input. Pointers to scaling factors (in host memory) used to blend the computation result with prior value in the output layer as follows:

```
dstValue = alpha[0]*result + beta[0]*priorDstValue
```

For more information, see the [Scaling Parameters](#) section in the *cuDNN Developer Guide*.

xDesc

Input. Handle to the previously initialized input tensor descriptor.

x

Input. Data pointer to GPU memory associated with the tensor descriptor xDesc.

yDesc

Input. Handle to the previously initialized output tensor descriptor.

y

Output. Data pointer to GPU memory associated with the output tensor descriptor yDesc.

Returns

CUDNN_STATUS_SUCCESS

The function launched successfully.

CUDNN_STATUS_NOT_SUPPORTED

The function does not support the provided configuration.

CUDNN_STATUS_BAD_PARAM

At least one of the following conditions are met:

- ▶ The dimensions `n`, `c`, `h`, `w` of the input tensor and output tensors differ.
- ▶ The `datatype` of the input tensor and output tensors differ.
- ▶ The parameters `algorithm` or `mode` have an invalid enumerant value.

CUDNN_STATUS_EXECUTION_FAILED

The function failed to launch on the GPU.

3.2.99. cudnnSpatialTfGridGeneratorForward()

```

cudnnStatus_t cudnnSpatialTfGridGeneratorForward(
    cudnnHandle_t          handle,
    const cudnnSpatialTransformerDescriptor_t stDesc,
    const void             *theta,
    void                  *grid)
    
```

This function generates a grid of coordinates in the input tensor corresponding to each pixel from the output tensor.

 **Note:** Only 2d transformation is supported.

Parameters

handle

Input. Handle to a previously created cuDNN context.

stDesc

Input. Previously created spatial transformer descriptor object.

theta

Input. Affine transformation matrix. It should be of size $n \times 2 \times 3$ for a 2d transformation, where n is the number of images specified in `stDesc`.

grid

Output. A grid of coordinates. It is of size $n \times h \times w \times 2$ for a 2d transformation, where n , h , w is specified in `stDesc`. In the 4th dimension, the first coordinate is x , and the second coordinate is y .

Returns

CUDNN_STATUS_SUCCESS

The call was successful.

CUDNN_STATUS_BAD_PARAM

At least one of the following conditions are met:

- ▶ handle is NULL.
- ▶ One of the parameters grid or theta is NULL.

CUDNN_STATUS_NOT_SUPPORTED

The function does not support the provided configuration. See the following for some examples of non-supported configurations:

- ▶ The dimension of the transformed tensor specified in stDesc > 4.

CUDNN_STATUS_EXECUTION_FAILED

The function failed to launch on the GPU.

3.2.100. cudnnSpatialTfSamplerForward()

```

cudnnStatus_t cudnnSpatialTfSamplerForward(
    cudnnHandle_t          handle,
    const cudnnSpatialTransformerDescriptor_t stDesc,
    const void             *alpha,
    const cudnnTensorDescriptor_t xDesc,
    const void             *x,
    const void             *grid,
    const void             *beta,
    cudnnTensorDescriptor_t yDesc,
    void                  *y)
    
```

This function performs a sampler operation and generates the output tensor using the grid given by the grid generator.

 **Note:** Only 2d transformation is supported.

Parameters

handle

Input. Handle to a previously created cuDNN context.

stDesc

Input. Previously created spatial transformer descriptor object.

alpha, beta

Input. Pointers to scaling factors (in host memory) used to blend the source value with prior value in the destination tensor as follows:

$$dstValue = alpha[0]*srcValue + beta[0]*priorDstValue$$

For more information, see the [Scaling Parameters](#) section in the *cuDNN Developer Guide*.

xDesc

Input. Handle to the previously initialized input tensor descriptor.

x

Input. Data pointer to GPU memory associated with the tensor descriptor xDesc.

grid

Input. A grid of coordinates generated by [cudnnSpatialTfGridGeneratorForward\(\)](#).

yDesc

Input. Handle to the previously initialized output tensor descriptor.

y

Output. Data pointer to GPU memory associated with the output tensor descriptor yDesc.

Returns

CUDNN_STATUS_SUCCESS

The call was successful.

CUDNN_STATUS_BAD_PARAM

At least one of the following conditions are met:

- ▶ handle is NULL.
- ▶ One of the parameters x, y or grid is NULL.

CUDNN_STATUS_NOT_SUPPORTED

The function does not support the provided configuration. See the following for some examples of non-supported configurations:

- ▶ The dimension of transformed tensor > 4.

CUDNN_STATUS_EXECUTION_FAILED

The function failed to launch on the GPU.

3.2.101. cudnnTransformFilter()

```

cudnnStatus_t cudnnTransformTensorEx(
    cudnnHandle_t handle,
    const cudnnTensorTransformDescriptor_t transDesc,

    const void *alpha,
    const cudnnFilterDescriptor_t srcDesc,
    const void *srcData,
    const void *beta,
    const cudnnFilterDescriptor_t destDesc,
    void *destData);
    
```

This function converts the filter between different formats, data types, or dimensions based on the described transformation. It can be used to convert a filter with an unsupported layout format to a filter with a supported layout format.

This function copies the scaled data from the input filter srcDesc to the output tensor destDesc with a different layout. If the filter descriptors of srcDesc and destDesc have different dimensions, they must be consistent with folding and padding amount and order specified in transDesc.

The `srcDesc` and `destDesc` tensors must not overlap in any way (meaning, tensors cannot be transformed in place).



Note: When performing a folding transform or a zero-padding transform, the scaling factors (`alpha`, `beta`) should be set to (1, 0). However, unfolding transforms support any (`alpha`, `beta`) values. This function is thread safe.

Parameters

handle

Input. Handle to a previously created cuDNN context. For more information, see [cudnnHandle_t](#).

transDesc

Input. A descriptor containing the details of the requested filter transformation. For more information, see [cudnnTensorTransformDescriptor_t](#).

alpha, beta

Input. Pointers, in the host memory, to the scaling factors used to scale the data in the input tensor `srcDesc`. `beta` is used to scale the destination tensor, while `alpha` is used to scale the source tensor. For more information, see the [Scaling Parameters](#) section in the *cuDNN Developer Guide*.

The `beta` scaling value is not honored in the folding and zero-padding cases. Unfolding supports any (`alpha`, `beta`).

srcDesc, destDesc

Input. Handles to the previously initiated filter descriptors. `srcDesc` and `destDesc` must not overlap. For more information, see [cudnnTensorDescriptor_t](#).

srcData, destData

Input. Pointers, in the host memory, to the data of the tensor described by `srcDesc` and `destDesc` respectively.

Returns

CUDNN_STATUS_SUCCESS

The function launched successfully.

CUDNN_STATUS_BAD_PARAM

A parameter is uninitialized or initialized incorrectly, or the number of dimensions is different between `srcDesc` and `destDesc`.

CUDNN_STATUS_NOT_SUPPORTED

The function does not support the provided configuration. Also, in the folding and padding paths, any value other than `A=1` and `B=0` will result in a `CUDNN_STATUS_NOT_SUPPORTED`.

CUDNN_STATUS_EXECUTION_FAILED

The function failed to launch on the GPU.

3.2.102. cudnnTransformTensor()

```

cudnnStatus_t cudnnTransformTensor(
    cudnnHandle_t          handle,
    const void             *alpha,
    const cudnnTensorDescriptor_t xDesc,
    const void             *x,
    const void             *beta,
    const cudnnTensorDescriptor_t yDesc,
    void                   *y)
    
```

This function copies the scaled data from one tensor to another tensor with a different layout. Those descriptors need to have the same dimensions but not necessarily the same strides. The input and output tensors must not overlap in any way (meaning, tensors cannot be transformed in place). This function can be used to convert a tensor with an unsupported format to a supported one.

Parameters

handle

Input. Handle to a previously created cuDNN context.

alpha, beta

Input. Pointers to scaling factors (in host memory) used to blend the source value with prior value in the destination tensor as follows:

```
dstValue = alpha[0]*srcValue + beta[0]*priorDstValue
```

For more information, see the [Scaling Parameters](#) section in the *cuDNN Developer Guide*.

xDesc

Input. Handle to a previously initialized tensor descriptor. For more information, see [cudnnTensorDescriptor_t](#).

x

Input. Pointer to data of the tensor described by the xDesc descriptor.

yDesc

Input. Handle to a previously initialized tensor descriptor. For more information, see [cudnnTensorDescriptor_t](#).

y

Output. Pointer to data of the tensor described by the yDesc descriptor.

Returns

CUDNN_STATUS_SUCCESS

The function launched successfully.

CUDNN_STATUS_NOT_SUPPORTED

The function does not support the provided configuration.

CUDNN_STATUS_BAD_PARAM

The dimensions `n`, `c`, `h`, `w` or the `dataType` of the two tensor descriptors are different.

CUDNN_STATUS_EXECUTION_FAILED

The function failed to launch on the GPU.

3.2.103. `cudnnTransformTensorEx()`

```

cudnnStatus_t cudnnTransformTensorEx(
    cudnnHandle_t handle,
    const cudnnTensorTransformDescriptor_t transDesc,

    const void *alpha,
    const cudnnTensorDescriptor_t srcDesc,
    const void *srcData,
    const void *beta,
    const cudnnTensorDescriptor_t destDesc,
    void *destData);

```

This function converts the tensor layouts between different formats. It can be used to convert a tensor with an unsupported layout format to a tensor with a supported layout format.

This function copies the scaled data from the input tensor `srcDesc` to the output tensor `destDesc` with a different layout. The tensor descriptors of `srcDesc` and `destDesc` should have the same dimensions but need not have the same strides.

The `srcDesc` and `destDesc` tensors must not overlap in any way (meaning, tensors cannot be transformed in place).



Note: When performing a folding transform or a zero-padding transform, the scaling factors (`alpha`, `beta`) should be set to (1, 0). However, unfolding transforms support any (`alpha`, `beta`) values. This function is thread safe.

Parameters

handle

Input. Handle to a previously created cuDNN context. For more information, see [cudnnHandle_t](#).

transDesc

Input. A descriptor containing the details of the requested tensor transformation. For more information, see [cudnnTensorTransformDescriptor_t](#).

alpha, beta

Input. Pointers, in the host memory, to the scaling factors used to scale the data in the input tensor `srcDesc`. `beta` is used to scale the destination tensor, while `alpha` is used to scale the source tensor. For more information, see the [Scaling Parameters](#) section in the *cuDNN Developer Guide*.

The beta scaling value is not honored in the folding and zero-padding cases. Unfolding supports any (alpha, beta).

srcDesc, destDesc

Input. Handles to the previously initiated tensor descriptors. `srcDesc` and `destDesc` must not overlap. For more information, see [cudnnTensorDescriptor_t](#).

srcData, destData

Input. Pointers, in the host memory, to the data of the tensor described by `srcDesc` and `destDesc` respectively.

Returns

CUDNN_STATUS_SUCCESS

The function was launched successfully.

CUDNN_STATUS_BAD_PARAM

A parameter is uninitialized or initialized incorrectly, or the number of dimensions is different between `srcDesc` and `destDesc`.

CUDNN_STATUS_NOT_SUPPORTED

Function does not support the provided configuration. Also, in the folding and padding paths, any value other than $A=1$ and $B=0$ will result in a `CUDNN_STATUS_NOT_SUPPORTED`.

CUDNN_STATUS_EXECUTION_FAILED

Function failed to launch on the GPU.

Chapter 4. `cuda_ops_train.so` Library

4.1. API Functions

4.1.1. `cudaActivationBackward()`

```
cudaStatus_t cudaActivationBackward(  
    cudaHandle_t          handle,  
    cudaActivationDescriptor_t activationDesc,  
    const void           *alpha,  
    const cudaTensorDescriptor_t yDesc,  
    const void           *y,  
    const cudaTensorDescriptor_t dyDesc,  
    const void           *dy,  
    const cudaTensorDescriptor_t xDesc,  
    const void           *x,  
    const void           *beta,  
    const cudaTensorDescriptor_t dxDesc,  
    void                 *dx)
```

This routine computes the gradient of a neuron activation function.



Note:

- ▶ In-place operation is allowed for this routine; meaning `dy` and `dx` pointers may be equal. However, this requires the corresponding tensor descriptors to be identical (particularly, the strides of the input and output must match for an in-place operation to be allowed).
- ▶ All tensor formats are supported for 4 and 5 dimensions, however, the best performance is obtained when the strides of `yDesc` and `xDesc` are equal and HW-packed. For more than 5 dimensions the tensors must have their spatial dimensions packed.

Parameters

handle

Input. Handle to a previously created cuDNN context. For more information, see [cudaHandle_t](#).

activationDesc

Input. Activation descriptor. See [cudaActivationDescriptor_t](#).

alpha, beta

Input. Pointers to scaling factors (in host memory) used to blend the computation result with prior value in the output layer as follows:

```
dstValue = alpha[0]*result + beta[0]*priorDstValue
```

For more information, see [Scaling Parameters](#) in the *cuDNN Developer Guide*.

yDesc

Input. Handle to the previously initialized input tensor descriptor. For more information, see [cudaTensorDescriptor_t](#).

y

Input. Data pointer to GPU memory associated with the tensor descriptor `yDesc`.

dyDesc

Input. Handle to the previously initialized input differential tensor descriptor.

dy

Input. Data pointer to GPU memory associated with the tensor descriptor `dyDesc`.

xDesc

Input. Handle to the previously initialized output tensor descriptor.

x

Input. Data pointer to GPU memory associated with the output tensor descriptor `xDesc`.

dxDesc

Input. Handle to the previously initialized output differential tensor descriptor.

dx

Output. Data pointer to GPU memory associated with the output tensor descriptor `dxDesc`.

Returns

CUDNN_STATUS_SUCCESS

The function launched successfully.

CUDNN_STATUS_BAD_PARAM

At least one of the following conditions are met:

- ▶ The strides `nStride`, `cStride`, `hStride`, `wStride` of the input differential tensor and output differential tensor differ and in-place operation is used.

CUDNN_STATUS_NOT_SUPPORTED

The function does not support the provided configuration. See the following for some examples of non-supported configurations:

- ▶ The dimensions n , c , h , w of the input tensor and output tensor differ.
- ▶ The datatype of the input tensor and output tensor differs.
- ▶ The strides $nStride$, $cStride$, $hStride$, $wStride$ of the input tensor and the input differential tensor differ.
- ▶ The strides $nStride$, $cStride$, $hStride$, $wStride$ of the output tensor and the output differential tensor differ.

CUDNN_STATUS_EXECUTION_FAILED

The function failed to launch on the GPU.

4.1.2. cudnnBatchNormalizationBackward()

```

cudaStatus_t cudnnBatchNormalizationBackward(
    cudnnHandle_t          handle,
    cudnnBatchNormMode_t  mode,
    const void             *alphaDataDiff,
    const void             *betaDataDiff,
    const void             *alphaParamDiff,
    const void             *betaParamDiff,
    const cudnnTensorDescriptor_t xDesc,
    const void             *x,
    const cudnnTensorDescriptor_t dyDesc,
    const void             *dy,
    const cudnnTensorDescriptor_t dxDesc,
    void                  *dx,
    const cudnnTensorDescriptor_t bnScaleBiasDiffDesc,
    const void             *bnScale,
    void                  *resultBnScaleDiff,
    void                  *resultBnBiasDiff,
    double                epsilon,
    const void             *savedMean,
    const void             *savedInvVariance)
    
```

This function performs the backward batch normalization layer computation. This layer is based on the paper [Batch Normalization: Accelerating Deep Network Training by Reducing Internal Covariate Shift, S. Ioffe, C. Szegedy, 2015.](#)

Note:

- ▶ Only 4D and 5D tensors are supported.
- ▶ The `epsilon` value has to be the same during training, backpropagation, and inference.
- ▶ Higher performance can be obtained when HW-packed tensors are used for all of `x`, `dy`, `dx`.

For more information, see [cudnnDeriveBNTensorDescriptor\(\)](#) for the secondary tensor descriptor generation for the parameters used in this function.

Parameters

handle

Input. Handle to a previously created cuDNN library descriptor. For more information, see [cudnnHandle_t](#).

mode

Input. Mode of operation (spatial or per-activation). For more information, see [cudaBatchNormMode_t](#).

***alphaDataDiff, *betaDataDiff**

Inputs. Pointers to scaling factors (in host memory) used to blend the gradient output dx with a prior value in the destination tensor as follows:

```
dstValue = alphaDataDiff[0]*resultValue + betaDataDiff[0]*priorDstValue
```

For more information, see [Scaling Parameters](#) in the *cuDNN Developer Guide*.

***alphaParamDiff, *betaParamDiff**

Inputs. Pointers to scaling factors (in host memory) used to blend the gradient outputs resultBnScaleDiff and resultBnBiasDiff with prior values in the destination tensor as follows:

```
dstValue = alphaParamDiff[0]*resultValue + betaParamDiff[0]*priorDstValue
```

For more information, see [Scaling Parameters](#).

xDesc, dxDesc, dyDesc

Inputs. Handles to the previously initialized tensor descriptors.

***x**

Input. Data pointer to GPU memory associated with the tensor descriptor xDesc, for the layer's x data.

***dy**

Inputs. Data pointer to GPU memory associated with the tensor descriptor dyDesc, for the backpropagated differential dy input.

***dx**

Inputs. Data pointer to GPU memory associated with the tensor descriptor dxDesc, for the resulting differential output with respect to x.

bnScaleBiasDiffDesc

Input. Shared tensor descriptor for the following five tensors: bnScale, resultBnScaleDiff, resultBnBiasDiff, savedMean, savedInvVariance. The dimensions for this tensor descriptor are dependent on normalization mode. For more information, see [cudaDeriveBNTensorDescriptor\(\)](#).

 **Note:** The data type of this tensor descriptor must be float for FP16 and FP32 input tensors, and double for FP64 input tensors.

***bnScale**

Input. Pointer in the device memory for the batch normalization scale parameter (in the original paper the quantity scale is referred to as gamma).

 **Note:** The `bnBias` parameter is not needed for this layer's computation.

resultBnScaleDiff, resultBnBiasDiff

Outputs. Pointers in device memory for the resulting scale and bias differentials computed by this routine. Note that these scale and bias gradients are weight gradients specific to this batch normalization operation, and by definition are not backpropagated.

epsilon

Input. Epsilon value used in batch normalization formula. Its value should be equal to or greater than the value defined for `CUDNN_BN_MIN_EPSILON` in `cuda.h`. The same `epsilon` value should be used in forward and backward functions.

***savedMean, *savedInvVariance**

Inputs. Optional cache parameters containing saved intermediate results that were computed during the forward pass. For this to work correctly, the layer's `x` and `bnScale` data have to remain unchanged until this backward function is called.

 **Note:** Both these parameters can be `NULL` but only at the same time. It is recommended to use this cache since the memory overhead is relatively small.

Supported configurations

This function supports the following combinations of data types for various descriptors.

Table 9. Supported configurations

Data Type	Configurations	xDesc	bnScaleBiasM	alphaDataDiff, betaDataDiff, alphaDataDiff, betaParamDiff	dyDesc	dxDesc
PSEUDO_HALF_CONFIG	CUDNN_DATA_HALF	CUDNN_DATA_HALF	CUDNN_DATA_FLOAT	CUDNN_DATA_FLOAT	CUDNN_DATA_HALF	CUDNN_DATA_HALF
FLOAT_CONFIG	CUDNN_DATA_FLOAT	CUDNN_DATA_FLOAT	CUDNN_DATA_FLOAT	CUDNN_DATA_FLOAT	CUDNN_DATA_FLOAT	CUDNN_DATA_FLOAT
DOUBLE_CONFIG	CUDNN_DATA_DOUBLE	CUDNN_DATA_DOUBLE	CUDNN_DATA_DOUBLE	CUDNN_DATA_DOUBLE	CUDNN_DATA_DOUBLE	CUDNN_DATA_DOUBLE

Returns

CUDNN_STATUS_SUCCESS

The computation was performed successfully.

CUDNN_STATUS_NOT_SUPPORTED

The function does not support the provided configuration.

CUDNN_STATUS_BAD_PARAM

At least one of the following conditions are met:

- ▶ Any of the pointers `alpha`, `beta`, `x`, `dy`, `dx`, `bnScale`, `resultBnScaleDiff`, `resultBnBiasDiff` is NULL.
- ▶ The number of `xDesc` or `yDesc` or `dxDesc` tensor descriptor dimensions is not within the range of [4, 5] (only 4D and 5D tensors are supported).
- ▶ `bnScaleBiasDiffDesc` dimensions are not 1xCx1x1 for 4D and 1xCx1x1x1 for 5D for spatial, and are not 1xCxHxW for 4D and 1xCxDxHxW for 5D for per-activation mode.
- ▶ Exactly one of `savedMean`, `savedInvVariance` pointers is NULL.
- ▶ `epsilon` value is less than CUDNN_BN_MIN_EPSILON.
- ▶ Dimensions or data types mismatch for any pair of `xDesc`, `dyDesc`, `dxDesc`.

4.1.3. cudnnBatchNormalizationBackwardEx()

```

cudnnStatus_t cudnnBatchNormalizationBackwardEx (
    cudnnHandle_t             handle,
    cudnnBatchNormMode_t     mode,
    cudnnBatchNormOps_t      bnOps,
    const void                *alphaDataDiff,
    const void                *betaDataDiff,
    const void                *alphaParamDiff,
    const void                *betaParamDiff,
    const cudnnTensorDescriptor_t xDesc,
    const void                *xData,
    const cudnnTensorDescriptor_t yDesc,
    const void                *yData,
    const cudnnTensorDescriptor_t dyDesc,
    const void                *dyData,
    const cudnnTensorDescriptor_t dzDesc,
    void                      *dzData,
    const cudnnTensorDescriptor_t dxDesc,
    void                      *dxData,
    const cudnnTensorDescriptor_t dBnScaleBiasDesc,
    const void                *bnScaleData,
    const void                *bnBiasData,
    void                      *dBnScaleData,
    void                      *dBnBiasData,
    double                    epsilon,
    const void                *savedMean,
    const void                *savedInvVariance,
    const cudnnActivationDescriptor_t activationDesc,
    void                      *workspace,
    size_t                    workSpaceSizeInBytes
    void                      *reserveSpace
    size_t                    reserveSpaceSizeInBytes);

```

This function is an extension of the [cudnnBatchNormalizationBackward\(\)](#) for performing the backward batch normalization layer computation with a fast NHWC semi-persistent kernel. This API will trigger the new semi-persistent NHWC kernel when the following conditions are true:

- ▶ All tensors, namely, `x`, `y`, `dz`, `dy`, `dx` must be NHWC-fully packed, and must be of the type CUDNN_DATA_HALF.
- ▶ The input parameter `mode` must be set to CUDNN_BATCHNORM_SPATIAL_PERSISTENT.

- ▶ `workspace` is not NULL.
- ▶ Before cuDNN version 8.2.0, the tensor `c` dimension should always be a multiple of 4. After 8.2.0, the tensor `c` dimension should be a multiple of 4 only when `bnOps` is `CUDNN_BATCHNORM_OPS_BN_ADD_ACTIVATION`.
- ▶ `workspaceSizeInBytes` is equal or larger than the amount required by [`cudaGetBatchNormalizationBackwardExWorkspaceSize\(\)`](#).
- ▶ `reserveSpaceSizeInBytes` is equal or larger than the amount required by [`cudaGetBatchNormalizationTrainingExReserveSpaceSize\(\)`](#).
- ▶ The content in `reserveSpace` stored by [`cudaBatchNormalizationForwardTrainingEx\(\)`](#) must be preserved.

If `workspace` is NULL and `workspaceSizeInBytes` of zero is passed in, this API will function exactly like the non-extended function `cudaBatchNormalizationBackward`.

This `workspace` is not required to be clean. Moreover, the `workspace` does not have to remain unchanged between the forward and backward pass, as it is not used for passing any information.

This extended function can accept a `*workspace` pointer to the GPU workspace, and `workspaceSizeInBytes`, the size of the workspace, from the user.

The `bnOps` input can be used to set this function to perform either only the batch normalization, or batch normalization followed by activation, or batch normalization followed by element-wise addition and then activation.

Only 4D and 5D tensors are supported. The `epsilon` value has to be the same during the training, the backpropagation, and the inference.

When the tensor layout is NCHW, higher performance can be obtained when HW-packed tensors are used for `x`, `dy`, `dx`.

Parameters

handle

Input. Handle to a previously created cuDNN library descriptor. For more information, see [`cudaHandle_t`](#).

mode

Input. Mode of operation (spatial or per-activation). For more information, see [`cudaBatchNormMode_t`](#).

bnOps

Input. Mode of operation. Currently, `CUDNN_BATCHNORM_OPS_BN_ACTIVATION` and `CUDNN_BATCHNORM_OPS_BN_ADD_ACTIVATION` are only supported in the NHWC layout. For more information, see [`cudaBatchNormOps_t`](#). This input can be used to set this function to perform either only the batch normalization, or batch normalization followed by activation, or batch normalization followed by element-wise addition and then activation.

***alphaDataDiff, *betaDataDiff**

Inputs. Pointers to scaling factors (in host memory) used to blend the gradient output dx with a prior value in the destination tensor as follows:

$$dstValue = alpha[0]*resultValue + beta[0]*priorDstValue$$

For more information, see [Scaling Parameters](#) in the *cuDNN Developer Guide*.

***alphaParamDiff, *betaParamDiff**

Inputs. Pointers to scaling factors (in host memory) used to blend the gradient outputs $dBnScaleData$ and $dBnBiasData$ with prior values in the destination tensor as follows:

$$dstValue = alpha[0]*resultValue + beta[0]*priorDstValue$$

For more information, see [Scaling Parameters](#) in the *cuDNN Developer Guide*.

xDesc, *x, yDesc, *yData, dyDesc, *dyData

Inputs. Tensor descriptors and pointers in the device memory for the layer's x data, backpropagated gradient input dy , the original forward output y data. $yDesc$ and $yData$ are not needed if $bnOps$ is set to `CUDNN_BATCHNORM_OPS_BN`, users may pass `NULL`. For more information, see [cudaTensorDescriptor_t](#).

dzDesc, *dzData, dxDesc, *dxData

Outputs. Tensor descriptors and pointers in the device memory for the computed gradient output dz , and dx . $dzDesc$ and $*dzData$ are not needed when $bnOps$ is `CUDNN_BATCHNORM_OPS_BN` or `CUDNN_BATCHNORM_OPS_BN_ACTIVATION`, users may pass `NULL`. For more information, see [cudaTensorDescriptor_t](#).

dBnScaleBiasDesc

Input. Shared tensor descriptor for the following six tensors: $bnScaleData$, $bnBiasData$, $dBnScaleData$, $dBnBiasData$, $savedMean$, and $savedInvVariance$. For more information, see [cudaDeriveBNTensorDescriptor\(\)](#).

The dimensions for this tensor descriptor are dependent on normalization mode.



Note: The data type of this tensor descriptor must be `float` for FP16 and FP32 input tensors and `double` for FP64 input tensors.

For more information, see [cudaTensorDescriptor_t](#).

***bnScaleData**

Input. Pointer in the device memory for the batch normalization scale parameter (in the [original paper](#) the quantity scale is referred to as γ).

***bnBiasData**

Input. Pointers in the device memory for the batch normalization bias parameter (in the [original paper](#) bias is referred to as β). This parameter is used only when activation should be performed.

***dBnScaleData, dBnBiasData**

Inputs. Pointers in the device memory for the gradients of $bnScaleData$ and $bnBiasData$, respectively.

epsilon

Input. Epsilon value used in batch normalization formula. Its value should be equal to or greater than the value defined for CUDNN_BN_MIN_EPSILON in cudnn.h. The same epsilon value should be used in forward and backward functions.

***savedMean, *savedInvVariance**

Inputs. Optional cache parameters containing saved intermediate results computed during the forward pass. For this to work correctly, the layer's x and bnScaleData, bnBiasData data has to remain unchanged until this backward function is called. Note that both these parameters can be NULL but only at the same time. It is recommended to use this cache since the memory overhead is relatively small.

activationDesc

Input. Descriptor for the activation operation. When the bnOps input is set to either CUDNN_BATCHNORM_OPS_BN_ACTIVATION or CUDNN_BATCHNORM_OPS_BN_ADD_ACTIVATION then this activation is used, otherwise user may pass NULL.

workspace

Input. Pointer to the GPU workspace. If workspace is NULL and workspaceSizeInBytes of zero is passed in, then this API will function exactly like the non-extended function [cudnnBatchNormalizationBackward\(\)](#).

workspaceSizeInBytes

Input. The size of the workspace. It must be large enough to trigger the fast NHWC semi-persistent kernel by this function.

***reserveSpace**

Input. Pointer to the GPU workspace for the reserveSpace.

reserveSpaceSizeInBytes

Input. The size of the reserveSpace. It must be equal or larger than the amount required by [cudnnGetBatchNormalizationTrainingExReserveSpaceSize\(\)](#).

Supported configurations

This function supports the following combinations of data types for various descriptors.

Table 10. Supported configurations

Data Type Configurations	xDesc, yDesc	dBnScaleBiasDes	alphaDataDiff, betaDataDiff, alpha, betaParamDiff	dyDesc, dzDesc, dxDesc
PSEUDO_HALF_CONFIG	CUDNN_DATA_HALF	CUDNN_DATA_FLOAT	CUDNN_DATA_FLOAT	CUDNN_DATA_HALF
FLOAT_CONFIG	CUDNN_DATA_FLOAT	CUDNN_DATA_FLOAT	CUDNN_DATA_FLOAT	CUDNN_DATA_FLOAT
DOUBLE_CONFIG	CUDNN_DATA_DOUBLE	CUDNN_DATA_DOUBLE	CUDNN_DATA_DOUBLE	CUDNN_DATA_DOUBLE

Returns

CUDNN_STATUS_SUCCESS

The computation was performed successfully.

CUDNN_STATUS_NOT_SUPPORTED

The function does not support the provided configuration.

CUDNN_STATUS_BAD_PARAM

At least one of the following conditions are met:

- ▶ Any of the pointers `alphaDataDiff`, `betaDataDiff`, `alphaParamDiff`, `betaParamDiff`, `x`, `dy`, `dx`, `bnScale`, `resultBnScaleDiff`, `resultBnBiasDiff` is NULL.
- ▶ The number of `xDesc` or `yDesc` or `dxDesc` tensor descriptor dimensions is not within the range of [4, 5] (only 4D and 5D tensors are supported).
- ▶ `dBnScaleBiasDesc` dimensions not 1xCx1x1 for 4D and 1xCx1x1x1 for 5D for spatial, and are not 1xCxHxW for 4D and 1xCxDxHxW for 5D for per-activation mode.
- ▶ Exactly one of `savedMean`, `savedInvVariance` pointers is NULL.
- ▶ `epsilon` value is less than `CUDNN_BN_MIN_EPSILON`.
- ▶ Dimensions or data types mismatch for any pair of `xDesc`, `dyDesc`, `dxDesc`.

4.1.4. cudnnBatchNormalizationForwardTraining()

```

cudnnStatus_t cudnnBatchNormalizationForwardTraining(
    cudnnHandle_t          handle,
    cudnnBatchNormMode_t  mode,
    const void             *alpha,
    const void             *beta,
    const cudnnTensorDescriptor_t xDesc,
    const void             *x,
    const cudnnTensorDescriptor_t yDesc,
    void                   *y,
    const cudnnTensorDescriptor_t bnScaleBiasMeanVarDesc,
    const void             *bnScale,
    const void             *bnBias,
    double                 exponentialAverageFactor,
    void                   *resultRunningMean,
    void                   *resultRunningVariance,
    double                 epsilon,
    void                   *resultSaveMean,
    void                   *resultSaveInvVariance)
    
```

This function performs the forward batch normalization layer computation for the training phase. This layer is based on the paper [Batch Normalization: Accelerating Deep Network Training by Reducing Internal Covariate Shift](#), S. Ioffe, C. Szegedy, 2015.

 **Note:**

- ▶ Only 4D and 5D tensors are supported.
- ▶ The `epsilon` value has to be the same during training, backpropagation, and inference.

- ▶ For the inference phase, use `cudaBatchNormalizationForwardInference`.
- ▶ Higher performance can be obtained when HW-packed tensors are used for both x and y .

See [cudaDeriveBNTensorDescriptor\(\)](#) for the secondary tensor descriptor generation for the parameters used in this function.

Parameters

handle

Handle to a previously created cuDNN library descriptor. For more information, see [cudaHandle_t](#).

mode

Mode of operation (spatial or per-activation). For more information, see [cudaBatchNormMode_t](#).

alpha, beta

Inputs. Pointers to scaling factors (in host memory) used to blend the layer output value with prior value in the destination tensor as follows:

```
dstValue = alpha[0]*resultValue + beta[0]*priorDstValue
```

For more information, see [Scaling Parameters](#) in the *cuDNN Developer Guide*.

xDesc, yDesc

Tensor descriptors and pointers in device memory for the layer's x and y data. For more information, see [cudaTensorDescriptor_t](#).

*x

Input. Data pointer to GPU memory associated with the tensor descriptor `xDesc`, for the layer's x input data.

*y

Input. Data pointer to GPU memory associated with the tensor descriptor `yDesc`, for the output of the batch normalization layer.

bnScaleBiasMeanVarDesc

Shared tensor descriptor `desc` for the secondary tensor that was derived by [cudaDeriveBNTensorDescriptor\(\)](#). The dimensions for this tensor descriptor are dependent on the normalization mode.

bnScale, bnBias

Inputs. Pointers in device memory for the batch normalization scale and bias parameters (in the [original paper](#) bias is referred to as beta and scale as gamma). Note that `bnBias` parameter can replace the previous layer's bias parameter for improved efficiency.

exponentialAverageFactor

Input. Factor used in the moving average computation as follows:

```
runningMean = runningMean*(1-factor) + newMean*factor
```

Use a $factor=1/(1+n)$ at N -th call to the function to get Cumulative Moving Average (CMA) behavior such that:

$$CMA[n] = (x[1] + \dots + x[n]) / n$$

This is proved below:

$$\begin{aligned} CMA[n+1] &= (n * CMA[n] + x[n+1]) / (n+1) \\ &= ((n+1) * CMA[n] - CMA[n]) / (n+1) + x[n+1] / (n+1) \\ &= CMA[n] * (1 - 1 / (n+1)) + x[n+1] * 1 / (n+1) \\ &= CMA[n] * (1 - factor) + x[n+1] * factor \end{aligned}$$

resultRunningMean, resultRunningVariance

Inputs/Outputs. Running mean and variance tensors (these have the same descriptor as the bias and scale). Both of these pointers can be NULL but only at the same time. The value stored in resultRunningVariance (or passed as an input in inference mode) is the sample variance and is the moving average of `variance[x]` where the variance is computed either over batch or spatial+batch dimensions depending on the mode. If these pointers are not NULL, the tensors should be initialized to some reasonable values or to 0.

epsilon

Input. Epsilon value used in the batch normalization formula. Its value should be equal to or greater than the value defined for `CUDNN_BN_MIN_EPSILON` in `cuda.h`. The same epsilon value should be used in forward and backward functions.

resultSaveMean, resultSaveInvVariance

Outputs. Optional cache to save intermediate results computed during the forward pass. These buffers can be used to speed up the backward pass when supplied to the `cudaBatchNormalizationBackward()` function. The intermediate results stored in resultSaveMean and resultSaveInvVariance buffers should not be used directly by the user. Depending on the batch normalization mode, the results stored in resultSaveInvVariance may vary. For the cache to work correctly, the input layer data must remain unchanged until the backward function is called. Note that both parameters can be NULL but only at the same time. In such a case, intermediate statistics will not be saved, and `cudaBatchNormalizationBackward()` will have to re-compute them. It is recommended to use this cache as the memory overhead is relatively small because these tensors have a much lower product of dimensions than the data tensors.

Supported configurations

This function supports the following combinations of data types for various descriptors.

Table 11. Supported configurations

Data Type Configurations	xDesc	bnScaleBiasMean	alpha, beta	yDesc
PSEUDO_HALF_CONFIG	CUDNN_DATA_HALF	CUDNN_DATA_FLOAT	CUDNN_DATA_FLOAT	CUDNN_DATA_HALF
FLOAT_CONFIG	CUDNN_DATA_FLOAT	CUDNN_DATA_FLOAT	CUDNN_DATA_FLOAT	CUDNN_DATA_FLOAT

Data Type Configurations	xDesc	bnScaleBiasMean	alpha, beta	yDesc
DOUBLE_CONFIG	CUDNN_DATA_DOUBLE	CUDNN_DATA_DOUBLE	CUDNN_DATA_DOUBLE	CUDNN_DATA_DOUBLE

Returns

CUDNN_STATUS_SUCCESS

The computation was performed successfully.

CUDNN_STATUS_NOT_SUPPORTED

The function does not support the provided configuration.

CUDNN_STATUS_BAD_PARAM

At least one of the following conditions are met:

- ▶ One of the pointers `alpha`, `beta`, `x`, `y`, `bnScale`, `bnBias` is NULL.
- ▶ The number of `xDesc` or `yDesc` tensor descriptor dimensions is not within the range of [4, 5] (only 4D and 5D tensors are supported).
- ▶ `bnScaleBiasMeanVarDesc` dimensions are not 1xCx1x1 for 4D and 1xCx1x1x1 for 5D for spatial, and are not 1xCxHxW for 4D and 1xCxDxHxW for 5D for per-activation mode.
- ▶ Exactly one of `resultSaveMean`, `resultSaveInvVariance` pointers are NULL.
- ▶ Exactly one of `resultRunningMean`, `resultRunningInvVariance` pointers are NULL.
- ▶ `epsilon` value is less than CUDNN_BN_MIN_EPSILON.
- ▶ Dimensions or data types mismatch for `xDesc`, `yDesc`.

4.1.5. cudnnBatchNormalizationForwardTrainingEx ()

```

cudnnStatus_t cudnnBatchNormalizationForwardTrainingEx(
    cudnnHandle_t             handle,
    cudnnBatchNormMode_t     mode,
    cudnnBatchNormOps_t      bnOps,
    const void                *alpha,
    const void                *beta,
    const cudnnTensorDescriptor_t xDesc,
    const void                *xData,
    const cudnnTensorDescriptor_t zDesc,
    const void                *zData,
    const cudnnTensorDescriptor_t yDesc,
    void                      *yData,
    const cudnnTensorDescriptor_t bnScaleBiasMeanVarDesc,
    const void                *bnScaleData,
    const void                *bnBiasData,
    double                    exponentialAverageFactor,
    void                      *resultRunningMeanData,
    void                      *resultRunningVarianceData,
    double                    epsilon,
    void                      *saveMean,
    void                      *saveInvVariance,
    const cudnnActivationDescriptor_t activationDesc,
    void                      *workspace,
    size_t                    workspaceSizeInBytes,
    void                      *reserveSpace,
    size_t                    reserveSpaceSizeInBytes);

```

This function is an extension of the [cudnnBatchNormalizationForwardTraining\(\)](#) for performing the forward batch normalization layer computation.

This API will trigger the new semi-persistent NHWC kernel when the following conditions are true:

- ▶ All tensors, namely, x , y , dz , dy , dx must be NHWC-fully packed and must be of the type `CUDNN_DATA_HALF`.
- ▶ The input parameter `mode` must be set to `CUDNN_BATCHNORM_SPATIAL_PERSISTENT`.
- ▶ `workspace` is not `NULL`.
- ▶ Before cuDNN version 8.2.0, the tensor `c` dimension should always be a multiple of 4. After 8.2.0, the tensor `c` dimension should be a multiple of 4 only when `bnOps` is `CUDNN_BATCHNORM_OPS_BN_ADD_ACTIVATION`.
- ▶ `workspaceSizeInBytes` is equal or larger than the amount required by [cudnnGetBatchNormalizationForwardTrainingExWorkspaceSize\(\)](#).
- ▶ `reserveSpaceSizeInBytes` is equal or larger than the amount required by [cudnnGetBatchNormalizationTrainingExReserveSpaceSize\(\)](#).
- ▶ The content in `reserveSpace` stored by [cudnnBatchNormalizationForwardTrainingEx\(\)](#) must be preserved.

If `workspace` is `NULL` and `workspaceSizeInBytes` of zero is passed in, this API will function exactly like the non-extended function [cudnnBatchNormalizationForwardTraining\(\)](#).

This workspace is not required to be clean. Moreover, the workspace does not have to remain unchanged between the forward and backward pass, as it is not used for passing any information.

This extended function can accept a `*workspace` pointer to the GPU workspace, and `workspaceSizeInBytes`, the size of the workspace, from the user.

The `bnOps` input can be used to set this function to perform either only the batch normalization, or batch normalization followed by activation, or batch normalization followed by element-wise addition and then activation.

Only 4D and 5D tensors are supported. The `epsilon` value has to be the same during the training, the backpropagation, and the inference.

When the tensor layout is NCHW, higher performance can be obtained when HW-packed tensors are used for x , dy , dx .

Parameters

handle

Handle to a previously created cuDNN library descriptor. For more information, see [cudnnHandle_t](#).

mode

Mode of operation (spatial or per-activation). For more information, see [cudnnBatchNormMode_t](#).

bnOps

Input. Mode of operation for the fast NHWC kernel. See [cudaBatchNormOps_t](#). This input can be used to set this function to perform either only the batch normalization, or batch normalization followed by activation, or batch normalization followed by element-wise addition and then activation.

***alpha, *beta**

Inputs. Pointers to scaling factors (in host memory) used to blend the layer output value with prior value in the destination tensor as follows:

```
dstValue = alpha[0]*resultValue + beta[0]*priorDstValue
```

For more information, see [Scaling Parameters](#) in the *cuDNN Developer Guide*.

xDesc, *xDData, zDesc, *zData, yDesc, *yData

Tensor descriptors and pointers in device memory for the layer's input *x* and output *y*, and for the optional *z* tensor input for residual addition to the result of the batch normalization operation, prior to the activation. The optional *zDes* and **zData* descriptors are only used when *bnOps* is CUDNN_BATCHNORM_OPS_BN_ADD_ACTIVATION, otherwise users may pass NULL. When in use, *z* should have exactly the same dimension as *x* and the final output *y*. For more information, see [cudaTensorDescriptor_t](#).

bnScaleBiasMeanVarDesc

Shared tensor descriptor *desc* for the secondary tensor that was derived by [cudaDeriveBNTensorDescriptor\(\)](#). The dimensions for this tensor descriptor are dependent on the normalization mode.

***bnScaleData, *bnBiasData**

Inputs. Pointers in device memory for the batch normalization scale and bias parameters (in the [original paper](#), bias is referred to as beta and scale as gamma). Note that *bnBiasData* parameter can replace the previous layer's bias parameter for improved efficiency.

exponentialAverageFactor

Input. Factor used in the moving average computation as follows:

```
runningMean = runningMean*(1-factor) + newMean*factor
```

Use a *factor*=1/(1+n) at N-th call to the function to get Cumulative Moving Average (CMA) behavior such that:

```
CMA[n] = (x[1]+...+x[n])/n
```

This is proved below:

Writing

```
CMA[n+1] = (n*CMA[n]+x[n+1])/(n+1)
= ((n+1)*CMA[n]-CMA[n])/(n+1) + x[n+1]/(n+1)
= CMA[n]*(1-1/(n+1))+x[n+1]*1/(n+1)
= CMA[n]*(1-factor) + x[n+1]*factor
```

***resultRunningMeanData, *resultRunningVarianceData**

Inputs/Outputs. Pointers to the running mean and running variance data. Both these pointers can be NULL but only at the same time. The value stored in *resultRunningVarianceData* (or passed as an input in inference mode) is the sample variance and is the moving average of *variance[x]* where the variance is computed either

over batch or spatial+batch dimensions depending on the mode. If these pointers are not NULL, the tensors should be initialized to some reasonable values or to 0.

epsilon

Input. Epsilon value used in the batch normalization formula. Its value should be equal to or greater than the value defined for CUDNN_BN_MIN_EPSILON in cudnn.h. The same epsilon value should be used in forward and backward functions.

***saveMean, *saveInvVariance**

Outputs. Optional cache parameters containing saved intermediate results computed during the forward pass. For this to work correctly, the layer's x and bnScaleData, bnBiasData data has to remain unchanged until this backward function is called. Note that both these parameters can be NULL but only at the same time. It is recommended to use this cache since the memory overhead is relatively small.

activationDesc

Input. The tensor descriptor for the activation operation. When the bnOps input is set to either CUDNN_BATCHNORM_OPS_BN_ACTIVATION or CUDNN_BATCHNORM_OPS_BN_ADD_ACTIVATION then this activation is used, otherwise user may pass NULL.

***workspace, workSpaceSizeInBytes**

Inputs. *workspace is a pointer to the GPU workspace, and workSpaceSizeInBytes is the size of the workspace. When *workspace is not NULL and *workSpaceSizeInBytes is large enough, and the tensor layout is NHWC and the data type configuration is supported, then this function will trigger a new semi-persistent NHWC kernel for batch normalization. The workspace is not required to be clean. Also, the workspace does not need to remain unchanged between the forward and backward passes.

***reserveSpace**

Input. Pointer to the GPU workspace for the reserveSpace.

reserveSpaceSizeInBytes

Input. The size of the reserveSpace. Must be equal or larger than the amount required by [cudnnGetBatchNormalizationTrainingExReserveSpaceSize\(\)](#).

Supported configurations

This function supports the following combinations of data types for various descriptors.

Table 12. Supported configurations

Data Type	Configurations xDesc	bnScaleBiasMe	alpha, beta	zDesc	yDesc
PSEUDO_HALF_CONFIG	CUDNN_DATA_HALF	CUDNN_DATA_FLOAT	CUDNN_DATA_FLOAT	CUDNN_DATA_HALF	CUDNN_DATA_HALF
FLOAT_CONFIG	CUDNN_DATA_FLOAT	CUDNN_DATA_FLOAT	CUDNN_DATA_FLOAT	Not supported	CUDNN_DATA_FLOAT
DOUBLE_CONFIG	CUDNN_DATA_DOUBLE	CUDNN_DATA_DOUBLE	CUDNN_DATA_DOUBLE	Not supported	CUDNN_DATA_DOUBLE

Returns

CUDNN_STATUS_SUCCESS

The computation was performed successfully.

CUDNN_STATUS_NOT_SUPPORTED

The function does not support the provided configuration.

CUDNN_STATUS_BAD_PARAM

At least one of the following conditions are met:

- ▶ One of the pointers `alpha`, `beta`, `x`, `y`, `bnScaleData`, `bnBiasData` is NULL.
- ▶ The number of `xDesc` or `yDesc` tensor descriptor dimensions is not within the `[4, 5]` range (only 4D and 5D tensors are supported).
- ▶ `bnScaleBiasMeanVarDesc` dimensions are not `1xCx1x1` for 4D and `1xCx1x1x1` for 5D for spatial, and are not `1xCxHxW` for 4D and `1xCxDxHxW` for 5D for per-activation mode.
- ▶ Exactly one of `saveMean`, `saveInvVariance` pointers are NULL.
- ▶ Exactly one of `resultRunningMeanData`, `resultRunningInvVarianceData` pointers are NULL.
- ▶ `epsilon` value is less than `CUDNN_BN_MIN_EPSILON`.
- ▶ Dimensions or data types mismatch for `xDesc`, `yDesc`.

4.1.6. cudnnDivisiveNormalizationBackward()

```

cudnnStatus_t cudnnDivisiveNormalizationBackward(
    cudnnHandle_t          handle,
    cudnnLRNDescriptor_t  normDesc,
    cudnnDivNormMode_t    mode,
    const void             *alpha,
    const cudnnTensorDescriptor_t xDesc,
    const void             *x,
    const void             *means,
    const void             *dy,
    void                   *temp,
    void                   *temp2,
    const void             *beta,
    const cudnnTensorDescriptor_t dxDesc,
    void                   *dx,
    void                   *dMeans)
    
```

This function performs the backward `DivisiveNormalization` layer computation.

Note: Supported tensor formats are NCHW for 4D and NCDHW for 5D with any non-overlapping non-negative strides. Only 4D and 5D tensors are supported.

Parameters

handle

Input. Handle to a previously created cuDNN library descriptor.

normDesc

Input. Handle to a previously initialized LRN parameter descriptor (this descriptor is used for both LRN and `DivisiveNormalization` layers).

mode

Input. `DivisiveNormalization` layer mode of operation. Currently only `CUDNN_DIVNORM_PRECOMPUTED_MEANS` is implemented. Normalization is performed using the means input tensor that is expected to be precomputed by the user.

alpha, beta

Input. Pointers to scaling factors (in host memory) used to blend the layer output value with prior value in the destination tensor as follows:

```
dstValue = alpha[0]*resultValue + beta[0]*priorDstValue
```

For more information, see [Scaling Parameters](#) in the *cuDNN Developer Guide*.

xDesc, x, means

Input. Tensor descriptor and pointers in device memory for the layer's `x` and means data. Note that the `means` tensor is expected to be precomputed by the user. It can also contain any valid values (not required to be actual means, and can be for instance a result of a convolution with a Gaussian kernel).

dy

Input. Tensor pointer in device memory for the layer's `dy` cumulative loss differential data (error backpropagation).

temp, temp2

Workspace. Temporary tensors in device memory. These are used for computing intermediate values during the backward pass. These tensors do not have to be preserved from forward to backward pass. Both use `xDesc` as a descriptor.

dxDesc

Input. Tensor descriptor for `dx` and `dMeans`.

dx, dMeans

Output. Tensor pointers (in device memory) for the layers resulting cumulative gradients `dx` and `dMeans` ($dLoss/dx$ and $dLoss/dMeans$). Both share the same descriptor.

Returns

CUDNN_STATUS_SUCCESS

The computation was performed successfully.

CUDNN_STATUS_BAD_PARAM

At least one of the following conditions are met:

- ▶ One of the tensor pointers `x`, `dx`, `temp`, `temp2`, `dy` is NULL.

- ▶ Number of any of the input or output tensor dimensions is not within the [4, 5] range.
- ▶ Either alpha or beta pointer is NULL.
- ▶ A mismatch in dimensions between xDesc and dxDesc.
- ▶ LRN descriptor parameters are outside of their valid ranges.
- ▶ Any of the tensor strides is negative.

CUDNN_STATUS_UNSUPPORTED

The function does not support the provided configuration, for example, any of the input and output tensor strides mismatch (for the same dimension) is a non-supported configuration.

4.1.7. cudnnDropoutBackward()

```

cudnnStatus_t cudnnDropoutBackward(
    cudnnHandle_t      handle,
    const cudnnDropoutDescriptor_t dropoutDesc,
    const cudnnTensorDescriptor_t dydesc,
    const void         *dy,
    const cudnnTensorDescriptor_t dxdesc,
    void              *dx,
    void              *reserveSpace,
    size_t             reserveSpaceSizeInBytes)
    
```

This function performs backward dropout operation over dy returning results in dx. If during forward dropout operation value from x was propagated to y then during backward operation value from dy will be propagated to dx, otherwise, dx value will be set to 0.

 **Note:** Better performance is obtained for fully packed tensors.

Parameters

handle

Input. Handle to a previously created cuDNN context.

dropoutDesc

Input. Previously created dropout descriptor object.

dyDesc

Input. Handle to a previously initialized tensor descriptor.

dy

Input. Pointer to data of the tensor described by the dyDesc descriptor.

dxDesc

Input. Handle to a previously initialized tensor descriptor.

dx

Output. Pointer to data of the tensor described by the dxDesc descriptor.

reserveSpace

Input. Pointer to user-allocated GPU memory used by this function. It is expected that reserveSpace was populated during a call to cudnnDropoutForward and has not been changed.

reserveSpaceSizeInBytes

Input. Specifies the size in bytes of the provided memory for the reserve space

Returns

CUDNN_STATUS_SUCCESS

The call was successful.

CUDNN_STATUS_NOT_SUPPORTED

The function does not support the provided configuration.

CUDNN_STATUS_BAD_PARAM

At least one of the following conditions are met:

- ▶ The number of elements of input tensor and output tensors differ.
- ▶ The datatype of the input tensor and output tensors differs.
- ▶ The strides of the input tensor and output tensors differ and in-place operation is used (i.e., x and y pointers are equal).
- ▶ The provided reserveSpaceSizeInBytes is less than the value returned by cudnnDropoutGetReserveSpaceSize.
- ▶ cudnnSetDropoutDescriptor has not been called on dropoutDesc with the non-NULL states argument.

CUDNN_STATUS_EXECUTION_FAILED

The function failed to launch on the GPU.

4.1.8. cudnnGetBatchNormalizationBackwardExWorkspaceSize

```

cudnnStatus_t cudnnGetBatchNormalizationBackwardExWorkspaceSize(
    cudnnHandle_t          handle,
    cudnnBatchNormMode_t  mode,
    cudnnBatchNormOps_t   bnOps,
    const cudnnTensorDescriptor_t xDesc,
    const cudnnTensorDescriptor_t yDesc,
    const cudnnTensorDescriptor_t dyDesc,
    const cudnnTensorDescriptor_t dzDesc,
    const cudnnTensorDescriptor_t dxDesc,
    const cudnnTensorDescriptor_t dBnScaleBiasDesc,
    const cudnnActivationDescriptor_t activationDesc,
    size_t                 *sizeInBytes);
    
```

This function returns the amount of GPU memory workspace the user should allocate to be able to call cudnnGetBatchNormalizationBackwardExWorkspaceSize() function for the specified bnOps input setting. The workspace allocated will then be passed to the function cudnnGetBatchNormalizationBackwardExWorkspaceSize().

Parameters

handle

Input. Handle to a previously created cuDNN library descriptor. For more information, see [cudaHandle_t](#).

mode

Input. Mode of operation (spatial or per-activation). For more information, see [cudaBatchNormMode_t](#).

bnOps

Input. Mode of operation for the fast NHWC kernel. For more information, see [cudaBatchNormOps_t](#). This input can be used to set this function to perform either only the batch normalization, or batch normalization followed by activation, or batch normalization followed by element-wise addition and then activation.

xDesc, yDesc, dyDesc, dzDesc, dxDesc

Tensor descriptors and pointers in the device memory for the layer's x data, back propagated differential dy (inputs), the optional y input data, the optional dz output, and the dx output, which is the resulting differential with respect to x . For more information, see [cudaTensorDescriptor_t](#).

dBnScaleBiasDesc

Input. Shared tensor descriptor for the following six tensors: `bnScaleData`, `bnBiasData`, `dBnScaleData`, `dBnBiasData`, `savedMean`, and `savedInvVariance`. This is the shared tensor descriptor `desc` for the secondary tensor that was derived by [cudaDeriveBNTensorDescriptor\(\)](#). The dimensions for this tensor descriptor are dependent on normalization mode. Note that the data type of this tensor descriptor must be `float` for FP16 and FP32 input tensors, and `double` for FP64 input tensors.

activationDesc

Input. Descriptor for the activation operation. When the `bnOps` input is set to either `CUDNN_BATCHNORM_OPS_BN_ACTIVATION` or `CUDNN_BATCHNORM_OPS_BN_ADD_ACTIVATION`, then this activation is used, otherwise user may pass `NULL`.

*sizeInBytes

Output. Amount of GPU memory required for the workspace, as determined by this function, to be able to execute the [cudaGetBatchNormalizationForwardTrainingExWorkspaceSize\(\)](#) function with the specified `bnOps` input setting.

Returns

CUDNN_STATUS_SUCCESS

The computation was performed successfully.

CUDNN_STATUS_NOT_SUPPORTED

The function does not support the provided configuration.

CUDNN_STATUS_BAD_PARAM

At least one of the following conditions are met:

- ▶ Number of xDesc, yDesc or dxDesc tensor descriptor dimensions is not within the range of [4, 5] (only 4D and 5D tensors are supported).
- ▶ dBnScaleBiasDesc dimensions not 1xCx1x1 for 4D and 1xCx1x1x1 for 5D for spatial, and are not 1xCxHxW for 4D and 1xCxDxHxW for 5D for per-activation mode.
- ▶ Dimensions or data types mismatch for any pair of xDesc, dyDesc, dxDesc.

4.1.9. cudnnGetBatchNormalizationForwardTrainingExWorkspaceSize

```

cudnnStatus_t cudnnGetBatchNormalizationForwardTrainingExWorkspaceSize (
    cudnnHandle_t          handle,
    cudnnBatchNormMode_t  mode,
    cudnnBatchNormOps_t   bnOps,
    const cudnnTensorDescriptor_t xDesc,
    const cudnnTensorDescriptor_t zDesc,
    const cudnnTensorDescriptor_t yDesc,
    const cudnnTensorDescriptor_t bnScaleBiasMeanVarDesc,
    const cudnnActivationDescriptor_t activationDesc,
    size_t                 *sizeInBytes);
    
```

This function returns the amount of GPU memory workspace the user should allocate to be able to call cudnnGetBatchNormalizationForwardTrainingExWorkspaceSize() function for the specified bnOps input setting. The workspace allocated should then be passed by the user to the function cudnnGetBatchNormalizationForwardTrainingExWorkspaceSize().

Parameters

handle

Input. Handle to a previously created cuDNN library descriptor. For more information, see [cudnnHandle_t](#).

mode

Input. Mode of operation (spatial or per-activation). For more information, see [cudnnBatchNormMode_t](#).

bnOps

Input. Mode of operation for the fast NHWC kernel. For more information, see [cudnnBatchNormOps_t](#). This input can be used to set this function to perform either only the batch normalization, or batch normalization followed by activation, or batch normalization followed by element-wise addition and then activation.

xDesc, zDesc, yDesc

Tensor descriptors and pointers in the device memory for the layer's x data, the optional z input data, and the y output. zDesc is only needed when bnOps is

CUDNN_BATCHNORM_OPS_BN_ADD_ACTIVATION, otherwise the user may pass NULL. For more information, see [cudnnTensorDescriptor_t](#).

bnScaleBiasMeanVarDesc

Input. Shared tensor descriptor for the following six tensors: bnScaleData, bnBiasData, dBnScaleData, dBnBiasData, savedMean, and savedInvVariance. This is the shared tensor descriptor desc for the secondary tensor that was derived by [cudnnDeriveBNTensorDescriptor\(\)](#). The dimensions for this tensor descriptor are dependent on normalization mode. Note that the data type of this tensor descriptor must be float for FP16 and FP32 input tensors, and double for FP64 input tensors.

activationDesc

Input. Descriptor for the activation operation. When the bnOps input is set to either CUDNN_BATCHNORM_OPS_BN_ACTIVATION or CUDNN_BATCHNORM_OPS_BN_ADD_ACTIVATION then this activation is used, otherwise the user may pass NULL.

***sizeInBytes**

Output. Amount of GPU memory required for the workspace, as determined by this function, to be able to execute the cudnnGetBatchNormalizationForwardTrainingExWorkspaceSize() function with the specified bnOps input setting.

Returns

CUDNN_STATUS_SUCCESS

The computation was performed successfully.

CUDNN_STATUS_NOT_SUPPORTED

The function does not support the provided configuration.

CUDNN_STATUS_BAD_PARAM

At least one of the following conditions are met:

- ▶ Number of xDesc, yDesc or dxDesc tensor descriptor dimensions is not within the range of [4, 5] (only 4D and 5D tensors are supported).
- ▶ dBnScaleBiasDesc dimensions not 1xCx1x1 for 4D and 1xCx1x1x1 for 5D for spatial, and are not 1xCxHxW for 4D and 1xCxDxHxW for 5D for per-activation mode.
- ▶ Dimensions or data types mismatch for xDesc, yDesc.

4.1.10. **cudnnGetBatchNormalizationTrainingExReserveSpaceSize**

```

cudnnStatus_t cudnnGetBatchNormalizationTrainingExReserveSpaceSize(
    cudnnHandle_t             handle,
    cudnnBatchNormMode_t     mode,
    cudnnBatchNormOps_t      bnOps,
    const cudnnActivationDescriptor_t activationDesc,
    const cudnnTensorDescriptor_t xDesc,
    size_t                    *sizeInBytes);
    
```

This function returns the amount of reserve GPU memory workspace the user should allocate for the batch normalization operation, for the specified `bnOps` input setting. In contrast to the `workspace`, the reserved space should be preserved between the forward and backward calls, and the data should not be altered.

Parameters

handle

Input. Handle to a previously created cuDNN library descriptor. For more information, see [cudaHandle_t](#).

mode

Input. Mode of operation (spatial or per-activation). For more information, see [cudaBatchNormMode_t](#).

bnOps

Input. Mode of operation for the fast NHWC kernel. For more information, see [cudaBatchNormOps_t](#). This input can be used to set this function to perform either only the batch normalization, or batch normalization followed by activation, or batch normalization followed by element-wise addition and then activation.

xDesc

Tensor descriptors for the layer's `x` data. For more information, see [cudaTensorDescriptor_t](#).

activationDesc

Input. Descriptor for the activation operation. When the `bnOps` input is set to either `CUDNN_BATCHNORM_OPS_BN_ACTIVATION` or `CUDNN_BATCHNORM_OPS_BN_ADD_ACTIVATION` then this activation is used, otherwise user may pass `NULL`.

***sizeInBytes**

Output. Amount of GPU memory reserved.

Returns

CUDNN_STATUS_SUCCESS

The computation was performed successfully.

CUDNN_STATUS_NOT_SUPPORTED

The function does not support the provided configuration.

CUDNN_STATUS_BAD_PARAM

At least one of the following conditions are met:

- ▶ The `xDesc` tensor descriptor dimension is not within the `[4, 5]` range (only 4D and 5D tensors are supported).

4.1.11. `cudaGetNormalizationBackwardWorkspaceSize()`

`cudaStatus_t`

```

cudaGetNormalizationBackwardWorkspaceSize(cudaHandle_t handle,
                                          cudaNormMode_t mode,
                                          cudaNormOps_t normOps,
                                          cudaNormAlgo_t algo,
                                          const cudaTensorDescriptor_t xDesc,
                                          const cudaTensorDescriptor_t yDesc,
                                          const cudaTensorDescriptor_t dyDesc,
                                          const cudaTensorDescriptor_t dzDesc,
                                          const cudaTensorDescriptor_t dxDesc,
                                          const cudaTensorDescriptor_t
dNormScaleBiasDesc,
                                          const cudaActivationDescriptor_t
activationDesc,
                                          const cudaTensorDescriptor_t
normMeanVarDesc,
                                          size_t *sizeInBytes,
                                          int groupCnt);

```

This function returns the amount of GPU memory workspace the user should allocate to be able to call `cudaNormalizationBackward()` function for the specified `normOps` and `algo` input setting. The workspace allocated will then be passed to the function `cudaNormalizationBackward()`.

Parameters

handle

Input. Handle to a previously created cuDNN library descriptor. For more information, see [cudaHandle_t](#).

mode

Input. Mode of operation (per-channel or per-activation). For more information, see [cudaNormMode_t](#).

normOps

Input. Mode of post-operative. Currently `CUDNN_NORM_OPS_NORM_ACTIVATION` and `CUDNN_NORM_OPS_NORM_ADD_ACTIVATION` are only supported in the NHWC layout. For more information, see [cudaNormOps_t](#). This input can be used to set this function to perform either only the normalization, or normalization followed by activation, or normalization followed by element-wise addition and then activation.

algo

Input. Algorithm to be performed. For more information, see [cudaNormAlgo_t](#).

xDesc, yDesc, dyDesc, dzDesc, dxDesc

Tensor descriptors and pointers in the device memory for the layer's `x` data, back propagated differential `dy` (inputs), the optional `y` input data, the optional `dz` output, and the `dx` output, which is the resulting differential with respect to `x`. For more information, see [cudaTensorDescriptor_t](#).

dNormScaleBiasDesc

Input. Shared tensor descriptor for the following four tensors: `normScaleData`, `normBiasData`, `dNormScaleData`, `dNormBiasData`. The dimensions for this tensor descriptor are dependent on normalization mode. Note that the data type of this tensor

descriptor must be float for FP16 and FP32 input tensors, and double for FP64 input tensors.

activationDesc

Input. Descriptor for the activation operation. When the `normOps` input is set to either `CUDNN_NORM_OPS_NORM_ACTIVATION` or `CUDNN_NORM_OPS_NORM_ADD_ACTIVATION`, then this activation is used, otherwise the user may pass `NULL`.

normMeanVarDesc

Input. Shared tensor descriptor for the following tensors: `savedMean` and `savedInvVariance`. The dimensions for this tensor descriptor are dependent on normalization mode. Note that the data type of this tensor descriptor must be float for FP16 and FP32 input tensors, and double for FP64 input tensors.

***sizeInBytes**

Output. Amount of GPU memory required for the workspace, as determined by this function, to be able to execute the `cudaGetNormalizationForwardTrainingWorkspaceSize()` function with the specified `normOps` input setting.

groutCnt

Input. Only support 1 for now.

Returns

CUDNN_STATUS_SUCCESS

The computation was performed successfully.

CUDNN_STATUS_NOT_SUPPORTED

The function does not support the provided configuration.

CUDNN_STATUS_BAD_PARAM

At least one of the following conditions are met:

- ▶ Number of `xDesc`, `yDesc` or `dxDesc` tensor descriptor dimensions is not within the range of [4,5] (only 4D and 5D tensors are supported).
- ▶ `dNormScaleBiasDesc` dimensions not `1xCx1x1` for 4D and `1xCx1x1x1` for 5D for per-channel, and are not `1xCxHxW` for 4D and `1xCxDxHxW` for 5D for per-activation mode.
- ▶ Dimensions or data types mismatch for any pair of `xDesc`, `dyDesc`, `dxDesc`.

4.1.12. **cudaGetNormalizationForwardTrainingWorkspaceSize**

```

cudaStatus_t
cudaGetNormalizationForwardTrainingWorkspaceSize(cudaHandle_t handle,
                                                cudaNormMode_t mode,
                                                cudaNormOps_t normOps,
                                                cudaNormAlgo_t algo,
                                                const cudaTensorDescriptor_t xDesc,
                                                const cudaTensorDescriptor_t
zDesc,
```

```

yDesc,
normScaleBiasDesc,
activationDesc,
normMeanVarDesc,
const cudnnTensorDescriptor_t
const cudnnTensorDescriptor_t
const cudnnActivationDescriptor_t
const cudnnTensorDescriptor_t
size_t *sizeInBytes,
int groupCnt);

```

This function returns the amount of GPU memory workspace the user should allocate to be able to call [cudnnNormalizationForwardTraining\(\)](#) function for the specified `normOps` and `algo` input setting. The workspace allocated should then be passed by the user to the function [cudnnNormalizationForwardTraining\(\)](#).

Parameters

handle

Input. Handle to a previously created cuDNN library descriptor. For more information, see [cudnnHandle_t](#).

mode

Input. Mode of operation (per-channel or per-activation). For more information, see [cudnnNormMode_t](#).

normOps

Input. Mode of post-operative. Currently `CUDNN_NORM_OPS_NORM_ACTIVATION` and `CUDNN_NORM_OPS_NORM_ADD_ACTIVATION` are only supported in the NHWC layout. For more information, see [cudnnNormOps_t](#). This input can be used to set this function to perform either only the normalization, or normalization followed by activation, or normalization followed by element-wise addition and then activation.

algo

Input. Algorithm to be performed. For more information, see [cudnnNormAlgo_t](#).

xDesc, zDesc, yDesc

Tensor descriptors and pointers in the device memory for the layer's `x` data, the optional `z` input data, and the `y` output. `zDesc` is only needed when `normOps` is `CUDNN_NORM_OPS_NORM_ADD_ACTIVATION`, otherwise the user may pass `NULL`. For more information, see [cudnnTensorDescriptor_t](#).

normScaleBiasDesc

Input. Shared tensor descriptor for the following tensors: `normScaleData` and `normBiasData`. The dimensions for this tensor descriptor are dependent on normalization mode. Note that the data type of this tensor descriptor must be float for FP16 and FP32 input tensors, and double for FP64 input tensors.

activationDesc

Input. Descriptor for the activation operation. When the normOps input is set to either CUDNN_NORM_OPS_NORM_ACTIVATION or CUDNN_NORM_OPS_NORM_ADD_ACTIVATION, then this activation is used, otherwise the user may pass NULL.

normMeanVarDesc

Input. Shared tensor descriptor for the following tensors: savedMean and savedInvVariance. The dimensions for this tensor descriptor are dependent on normalization mode. Note that the data type of this tensor descriptor must be float for FP16 and FP32 input tensors, and double for FP64 input tensors.

***sizeInBytes**

Output. Amount of GPU memory required for the workspace, as determined by this function, to be able to execute the [cudnnGetNormalizationForwardTrainingWorkspaceSize\(\)](#) function with the specified normOps input setting.

groupCnt

Input. Only support 1 for now.

Returns

CUDNN_STATUS_SUCCESS

The computation was performed successfully.

CUDNN_STATUS_NOT_SUPPORTED

The function does not support the provided configuration.

CUDNN_STATUS_BAD_PARAM

At least one of the following conditions are met:

- ▶ Number of xDesc, yDesc or zDesc tensor descriptor dimensions is not within the range of [4,5] (only 4D and 5D tensors are supported).
- ▶ normScaleBiasDesc dimensions not 1xCx1x1 for 4D and 1xCx1x1x1 for 5D for per-channel, and are not 1xCxHxW for 4D and 1xCxDxHxW for 5D for per-activation mode.
- ▶ Dimensions or data types mismatch for xDesc, yDesc.

4.1.13. **cudnnGetNormalizationTrainingReserveSpaceSize**

```

cudnnStatus_t
cudnnGetNormalizationTrainingReserveSpaceSize(cudnnHandle_t handle,
                                              cudnnNormMode_t mode,
                                              cudnnNormOps_t normOps,
                                              cudnnNormAlgo_t algo,
                                              const cudnnActivationDescriptor_t
activationDesc,
                                              const cudnnTensorDescriptor_t xDesc,
                                              size_t *sizeInBytes,
                                              int groupCnt);
    
```

This function returns the amount of reserve GPU memory workspace the user should allocate for the normalization operation, for the specified `normOps` input setting. In contrast to the workspace, the reserved space should be preserved between the forward and backward calls, and the data should not be altered.

Parameters

handle

Input. Handle to a previously created cuDNN library descriptor. For more information, see [cudnnHandle_t](#).

mode

Input. Mode of operation (per-channel or per-activation). For more information, see [cudnnNormMode_t](#).

normOps

Input. Mode of post-operative. Currently `CUDNN_NORM_OPS_NORM_ACTIVATION` and `CUDNN_NORM_OPS_NORM_ADD_ACTIVATION` are only supported in the NHWC layout. For more information, see [cudnnNormOps_t](#). This input can be used to set this function to perform either only the normalization, or normalization followed by activation, or normalization followed by element-wise addition and then activation.

algo

Input. Algorithm to be performed. For more information, see [cudnnNormAlgo_t](#).

xDesc

Tensor descriptors for the layer's x data. For more information, see [cudnnTensorDescriptor_t](#).

activationDesc

Input. Descriptor for the activation operation. When the `normOps` input is set to either `CUDNN_NORM_OPS_NORM_ACTIVATION` or `CUDNN_NORM_OPS_NORM_ADD_ACTIVATION` then this activation is used, otherwise the user may pass `NULL`.

***sizeInBytes**

Output. Amount of GPU memory reserved.

groutCnt

Input. Only support 1 for now.

Returns

CUDNN_STATUS_SUCCESS

The computation was performed successfully.

CUDNN_STATUS_NOT_SUPPORTED

The function does not support the provided configuration.

CUDNN_STATUS_BAD_PARAM

At least one of the following conditions are met:

- ▶ The xDesc tensor descriptor dimension is not within the [4,5] range (only 4D and 5D tensors are supported).

4.1.14. cudnnLRNCrossChannelBackward()

```

cudnnStatus_t cudnnLRNCrossChannelBackward(
    cudnnHandle_t          handle,
    cudnnLRNDescriptor_t   normDesc,
    cudnnLRNMode_t        lrnMode,
    const void             *alpha,
    const cudnnTensorDescriptor_t yDesc,
    const void             *y,
    const cudnnTensorDescriptor_t dyDesc,
    const void             *dy,
    const cudnnTensorDescriptor_t xDesc,
    const void             *x,
    const void             *beta,
    const cudnnTensorDescriptor_t dxDesc,
    void                   *dx)
    
```

This function performs the backward LRN layer computation.



Note: Supported formats are: positive-strided, NCHW and NHWC for 4D x and y , and only NCDHW DHW-packed for 5D (for both x and y). Only non-overlapping 4D and 5D tensors are supported. NCHW layout is preferred for performance.

Parameters

handle

Input. Handle to a previously created cuDNN library descriptor.

normDesc

Input. Handle to a previously initialized LRN parameter descriptor.

lrnMode

Input. LRN layer mode of operation. Currently, only CUDNN_LRN_CROSS_CHANNEL_DIM1 is implemented. Normalization is performed along the tensor's $\text{dimA}[1]$.

alpha, beta

Input. Pointers to scaling factors (in host memory) used to blend the layer output value with prior value in the destination tensor as follows:

```
dstValue = alpha[0]*resultValue + beta[0]*priorDstValue
```

For more information, see [Scaling Parameters](#) in the *cuDNN Developer Guide*.

yDesc, y

Input. Tensor descriptor and pointer in device memory for the layer's y data.

dyDesc, dy

Input. Tensor descriptor and pointer in device memory for the layer's input cumulative loss differential data dy (including error backpropagation).

xDesc, x

Input. Tensor descriptor and pointer in device memory for the layer's x data. Note that these values are not modified during backpropagation.

dxDesc, dx

Output. Tensor descriptor and pointer in device memory for the layer's resulting cumulative loss differential data dx (including error backpropagation).

Returns

CUDNN_STATUS_SUCCESS

The computation was performed successfully.

CUDNN_STATUS_BAD_PARAM

At least one of the following conditions are met:

- ▶ One of the tensor pointers x , y is NULL.
- ▶ Number of input tensor dimensions is 2 or less.
- ▶ LRN descriptor parameters are outside of their valid ranges.
- ▶ One of the tensor parameters is 5D but is not in NCDHW DHW-packed format.

CUDNN_STATUS_NOT_SUPPORTED

The function does not support the provided configuration. See the following for some examples of non-supported configurations:

- ▶ Any of the input tensor datatypes is not the same as any of the output tensor datatype.
- ▶ Any pairwise tensor dimensions mismatch for x , y , dx , dy .
- ▶ Any tensor parameters strides are negative.

4.1.15. **cudaNormalizationBackward()**

```

cudaStatus_t
cudaNormalizationBackward(cudaHandle_t handle,
                          cudaNormMode_t mode,
                          cudaNormOps_t normOps,
                          cudaNormAlgo_t algo,
                          const void *alphaDataDiff,
                          const void *betaDataDiff,
                          const void *alphaParamDiff,
                          const void *betaParamDiff,
                          const cudaTensorDescriptor_t xDesc,
                          const void *xData,
                          const cudaTensorDescriptor_t yDesc,
                          const void *yData,
                          const cudaTensorDescriptor_t dyDesc,
                          const void *dyData,
                          const cudaTensorDescriptor_t dzDesc,

```



```

void *dzData,
const cudnnTensorDescriptor_t dxDesc,
void *dxData,
const cudnnTensorDescriptor_t dNormScaleBiasDesc,
const void *normScaleData,
const void *normBiasData,
void *dNormScaleData,
void *dNormBiasData,
double epsilon,
const cudnnTensorDescriptor_t normMeanVarDesc,
const void *savedMean,
const void *savedInvVariance,
cudnnActivationDescriptor_t activationDesc,
void *workSpace,
size_t workSpaceSizeInBytes,
void *reserveSpace,
size_t reserveSpaceSizeInBytes,
int groupCnt)

```

This function performs backward normalization layer computation that is specified by mode. Per-channel normalization layer is based on the paper [Batch Normalization: Accelerating Deep Network Training by Reducing Internal Covariate Shift, S. Ioffe, C. Szegedy, 2015](#).



Note: Only 4D and 5D tensors are supported.

The `epsilon` value has to be the same during training, backpropagation, and inference. This workspace is not required to be clean. Moreover, the workspace does not have to remain unchanged between the forward and backward pass, as it is not used for passing any information.

This function can accept a `*workSpace` pointer to the GPU workspace, and `workSpaceSizeInBytes`, the size of the workspace, from the user.

The `normOps` input can be used to set this function to perform either only the normalization, or normalization followed by activation, or normalization followed by element-wise addition and then activation.

When the tensor layout is NCHW, higher performance can be obtained when HW-packed tensors are used for `x`, `dy`, `dx`.

Higher performance for `CUDNN_NORM_PER_CHANNEL` mode can be obtained when the following conditions are true:

- ▶ All tensors, namely, `x`, `y`, `dz`, `dy`, and `dx` must be NHWC-fully packed, and must be of the type `CUDNN_DATA_HALF`.
- ▶ The tensor C dimension should be a multiple of 4.
- ▶ The input parameter `mode` must be set to `CUDNN_NORM_PER_CHANNEL`.
- ▶ The input parameter `algo` must be set to `CUDNN_NORM_ALGO_PERSIST`.
- ▶ `workSpace` is not `NULL`.
- ▶ `workSpaceSizeInBytes` is equal or larger than the amount required by [cudnnGetNormalizationBackwardWorkspaceSize\(\)](#).
- ▶ `reserveSpaceSizeInBytes` is equal or larger than the amount required by [cudnnGetNormalizationTrainingReserveSpaceSize\(\)](#).

- The content in `reserveSpace` stored by [cudnnNormalizationForwardTraining\(\)](#) must be preserved.

Parameters

handle

Input. Handle to a previously created cuDNN library descriptor. For more information, see [cudnnHandle_t](#).

mode

Input. Mode of operation (per-channel or per-activation). For more information, see [cudnnNormMode_t](#).

normOps

Input. Mode of post-operative. Currently `CUDNN_NORM_OPS_NORM_ACTIVATION` and `CUDNN_NORM_OPS_NORM_ADD_ACTIVATION` are only supported in the NHWC layout. For more information, see [cudnnNormOps_t](#). This input can be used to set this function to perform either only the normalization, or normalization followed by activation, or normalization followed by element-wise addition and then activation.

algo

Input. Algorithm to be performed. For more information, see [cudnnNormAlgo_t](#).

*alphaDataDiff, *betaDataDiff

Inputs. Pointers to scaling factors (in host memory) used to blend the gradient output `dx` with a prior value in the destination tensor as follows:

```
dstValue = alpha[0]*resultValue + beta[0]*priorDstValue
```

For more information, see [Scaling Parameters](#) in the *cuDNN Developer Guide*.

*alphaParamDiff, *betaParamDiff

Inputs. Pointers to scaling factors (in host memory) used to blend the gradient outputs `dNormScaleData` and `dNormBiasData` with prior values in the destination tensor as follows:

```
dstValue = alpha[0]*resultValue + beta[0]*priorDstValue
```

For more information, see [Scaling Parameters](#) in the *cuDNN Developer Guide*.

xDesc, *xData, yDesc, *yData, dyDesc, *dyData

Inputs. Tensor descriptors and pointers in the device memory for the layer's `x` data, backpropagated gradient input `dy`, the original forward output `y` data. `yDesc` and `yData` are not needed if `normOps` is set to `CUDNN_NORM_OPS_NORM`, users may pass `NULL`. For more information, see [cudnnTensorDescriptor_t](#).

dzDesc, *dzData, dxDesc, *dxData

Outputs. Tensor descriptors and pointers in the device memory for the computed gradient output `dz` and `dx`. `dzDesc` and `*dzData` is not needed when `normOps` is `CUDNN_NORM_OPS_NORM` or `CUDNN_NORM_OPS_NORM_ACTIVATION`, users may pass `NULL`. For more information, see [cudnnTensorDescriptor_t](#).

dNormScaleBiasDesc

Input. Shared tensor descriptor for the following six tensors: normScaleData, normBiasData, dNormScaleData, and dNormBiasData. The dimensions for this tensor descriptor are dependent on normalization mode.

 **Note:** The data type of this tensor descriptor must be float for FP16 and FP32 input tensors and double for FP64 input tensors.

For more information, see [cudnnTensorDescriptor_t](#).

***normScaleData**

Input. Pointer in the device memory for the normalization scale parameter (in the [original paper](#) the quantity scale is referred to as gamma).

***normBiasData**

Input. Pointers in the device memory for the normalization bias parameter (in the [original paper](#) bias is referred to as beta). This parameter is used only when activation should be performed.

***dNormScaleData, dNormBiasData**

Inputs. Pointers in the device memory for the gradients of normScaleData and normBiasData, respectively.

epsilon

Input. Epsilon value used in normalization formula. Its value should be equal to or greater than zero. The same epsilon value should be used in forward and backward functions.

normMeanVarDesc

Input. Shared tensor descriptor for the following tensors: savedMean and savedInvVariance. The dimensions for this tensor descriptor are dependent on normalization mode.

 **Note:** The data type of this tensor descriptor must be float for FP16 and FP32 input tensors and double for FP64 input tensors.

For more information, see [cudnnTensorDescriptor_t](#).

***savedMean, *savedInvVariance**

Inputs. Optional cache parameters containing saved intermediate results computed during the forward pass. For this to work correctly, the layer's x and normScaleData, normBiasData data has to remain unchanged until this backward function is called. Note that both these parameters can be NULL but only at the same time. It is recommended to use this cache since the memory overhead is relatively small.

activationDesc

Input. Descriptor for the activation operation. When the `normOps` input is set to either `CUDNN_NORM_OPS_NORM_ACTIVATION` or `CUDNN_NORM_OPS_NORM_ADD_ACTIVATION` then this activation is used, otherwise the user may pass `NULL`.

workspace

Input. Pointer to the GPU workspace.

workspaceSizeInBytes

Input. The size of the workspace. It must be large enough to trigger the fast NHWC semi-persistent kernel by this function.

***reserveSpace**

Input. Pointer to the GPU workspace for the `reserveSpace`.

reserveSpaceSizeInBytes

Input. The size of the `reserveSpace`. It must be equal or larger than the amount required by [cudnnGetNormalizationTrainingReserveSpaceSize\(\)](#).

groutCnt

Input. Only support 1 for now.

Returns

CUDNN_STATUS_SUCCESS

The computation was performed successfully.

CUDNN_STATUS_NOT_SUPPORTED

The function does not support the provided configuration.

CUDNN_STATUS_BAD_PARAM

At least one of the following conditions are met:

- ▶ Any of the pointers `alphaDataDiff`, `betaDataDiff`, `alphaParamDiff`, `betaParamDiff`, `xData`, `dyData`, `dxData`, `normScaleData`, `dNormScaleData`, and `dNormBiasData` is `NULL`.
- ▶ The number of `xDesc` or `yDesc` or `dxDesc` tensor descriptor dimensions is not within the range of [4,5] (only 4D and 5D tensors are supported).
- ▶ `dNormScaleBiasDesc` dimensions not `1xCx1x1` for 4D and `1xCx1x1x1` for 5D for per-channel, and are not `1xCxHxW` for 4D and `1xCxDxHxW` for 5D for per-activation mode.
- ▶ Exactly one of `savedMean`, `savedInvVariance` pointers is `NULL`.
- ▶ `epsilon` value is less than zero.
- ▶ Dimensions or data types mismatch for any pair of `xDesc`, `dyDesc`, `dxDesc`, `dNormScaleBiasDesc`, and `normMeanVarDesc`.

4.1.16. cudnnNormalizationForwardTraining()

```

cudnnStatus_t
cudnnNormalizationForwardTraining(cudnnHandle_t handle,
    cudnnNormMode_t mode,
    cudnnNormOps_t normOps,
    cudnnNormAlgo_t algo,
    const void *alpha,
    const void *beta,
    const cudnnTensorDescriptor_t xDesc,
    const void *xData,
    const cudnnTensorDescriptor_t normScaleBiasDesc,
    const void *normScale,
    const void *normBias,
    double exponentialAverageFactor,
    const cudnnTensorDescriptor_t normMeanVarDesc,
    void *resultRunningMean,
    void *resultRunningVariance,
    double epsilon,
    void *resultSaveMean,
    void *resultSaveInvVariance,
    cudnnActivationDescriptor_t activationDesc,
    const cudnnTensorDescriptor_t zDesc,
    const void *zData,
    const cudnnTensorDescriptor_t yDesc,
    void *yData,
    void *workspace,
    size_t workSpaceSizeInBytes,
    void *reserveSpace,
    size_t reserveSpaceSizeInBytes,
    int groupCnt);
    
```

This function performs the forward normalization layer computation for the training phase. Depending on mode, different normalization operations will be performed. Per-channel layer is based on the paper [Batch Normalization: Accelerating Deep Network Training by Reducing Internal Covariate Shift, S. Ioffe, C. Szegedy, 2015](#).



Note:

- ▶ Only 4D and 5D tensors are supported.
- ▶ The `epsilon` value has to be the same during training, back propagation, and inference.
- ▶ For the inference phase, use [cudnnNormalizationForwardInference\(\)](#).
- ▶ Higher performance can be obtained when HW-packed tensors are used for both `x` and `y`.

This API will trigger the new semi-persistent NHWC kernel when the following conditions are true:

- ▶ All tensors, namely, `xData`, `yData` must be NHWC-fully packed and must be of the type `CUDNN_DATA_HALF`.
- ▶ The tensor C dimension should be a multiple of 4.
- ▶ The input parameter `mode` must be set to `CUDNN_NORM_PER_CHANNEL`.
- ▶ The input parameter `algo` must be set to `CUDNN_NORM_ALGO_PERSIST`.
- ▶ `workspace` is not NULL.

- ▶ `workspaceSizeInBytes` is equal or larger than the amount required by [`cudaGetNormalizationForwardTrainingWorkspaceSize\(\)`](#).
- ▶ `reserveSpaceSizeInBytes` is equal or larger than the amount required by [`cudaGetNormalizationTrainingReserveSpaceSize\(\)`](#).
- ▶ The content in `reserveSpace` stored by [`cudaNormalizationForwardTraining\(\)`](#) must be preserved.

This `workspace` is not required to be clean. Moreover, the `workspace` does not have to remain unchanged between the forward and backward pass, as it is not used for passing any information. This extended function can accept a `*workspace` pointer to the GPU workspace, and `workspaceSizeInBytes`, the size of the workspace, from the user.

The `normOps` input can be used to set this function to perform either only the normalization, or normalization followed by activation, or normalization followed by element-wise addition and then activation.

Only 4D and 5D tensors are supported. The `epsilon` value has to be the same during the training, the backpropagation, and the inference.

When the tensor layout is NCHW, higher performance can be obtained when HW-packed tensors are used for `xData`, `yData`.

Parameters

handle

Input. Handle to a previously created cuDNN library descriptor. For more information, see [`cudaHandle_t`](#).

mode

Input. Mode of operation (per-channel or per-activation). For more information, see [`cudaNormMode_t`](#).

normOps

Input. Mode of post-operative. Currently `CUDNN_NORM_OPS_NORM_ACTIVATION` and `CUDNN_NORM_OPS_NORM_ADD_ACTIVATION` are only supported in the NHWC layout. For more information, see [`cudaNormOps_t`](#). This input can be used to set this function to perform either only the normalization, or normalization followed by activation, or normalization followed by element-wise addition and then activation.

algo

Input. Algorithm to be performed. For more information, see [`cudaNormAlgo_t`](#).

***alpha, *beta**

Inputs. Pointers to scaling factors (in host memory) used to blend the layer output value with prior value in the destination tensor as follows:

```
dstValue = alpha[0]*resultValue + beta[0]*priorDstValue
```

For more information, see [Scaling Parameters](#) in the *cuDNN Developer Guide*.

xDesc, yDesc

Input. Handles to the previously initialized tensor descriptors.

***xData**

Input. Data pointer to GPU memory associated with the tensor descriptor `xDesc`, for the layer's `x` input data.

***yData**

Output. Data pointer to GPU memory associated with the tensor descriptor `yDesc`, for the `y` output of the normalization layer.

zDesc, *zData

Input. Tensor descriptors and pointers in device memory for residual addition to the result of the normalization operation, prior to the activation. `zDesc` and `*zData` are optional and are only used when `normOps` is `CUDNN_NORM_OPS_NORM_ADD_ACTIVATION`, otherwise the user may pass `NULL`. When in use, `z` should have exactly the same dimension as `xData` and the final output `yData`. For more information, see [cudnnTensorDescriptor_t](#).

normScaleBiasDesc, normScale, normBias

Inputs. Tensor descriptors and pointers in device memory for the normalization scale and bias parameters (in the [original paper](#) bias is referred to as beta and scale as gamma). The dimensions for the tensor descriptor are dependent on the normalization mode.

exponentialAverageFactor

Input. Factor used in the moving average computation as follows:

$$\text{runningMean} = \text{runningMean} * (1 - \text{factor}) + \text{newMean} * \text{factor}$$

Use a `factor=1/(1+n)` at `N`-th call to the function to get Cumulative Moving Average (CMA) behavior such that:

$$\text{CMA}[n] = (\text{x}[1] + \dots + \text{x}[n]) / n$$

This is proved below:

Writing

$$\begin{aligned} \text{CMA}[n+1] &= (n * \text{CMA}[n] + \text{x}[n+1]) / (n+1) \\ &= ((n+1) * \text{CMA}[n] - \text{CMA}[n]) / (n+1) + \text{x}[n+1] / (n+1) \\ &= \text{CMA}[n] * (1 - 1 / (n+1)) + \text{x}[n+1] * 1 / (n+1) \\ &= \text{CMA}[n] * (1 - \text{factor}) + \text{x}[n+1] * \text{factor} \end{aligned}$$

normMeanVarDesc

Inputs. Tensor descriptor used for following tensors: `resultRunningMean`, `resultRunningVariance`, `resultSaveMean`, `resultSaveInvVariance`.

***resultRunningMean, *resultRunningVariance**

Inputs/Outputs. Pointers to the running mean and running variance data. Both these pointers can be `NULL` but only at the same time. The value stored in `resultRunningVariance` (or passed as an input in inference mode) is the sample variance and is the moving average of `variance[x]` where the variance is computed either over batch or spatial+batch dimensions depending on the mode. If these pointers are not `NULL`, the tensors should be initialized to some reasonable values or to 0.

epsilon

Input. Epsilon value used in the normalization formula. Its value should be equal to or greater than zero.

***resultSaveMean, *resultSaveInvVariance**

Outputs. Optional cache parameters containing saved intermediate results computed during the forward pass. For this to work correctly, the layer's `x` and `normScale`, `normBias` data has to remain unchanged until this backward function is called. Note that both these parameters can be `NULL` but only at the same time. It is recommended to use this cache since the memory overhead is relatively small.

activationDesc

Input. The tensor descriptor for the activation operation. When the `normOps` input is set to either `CUDNN_NORM_OPS_NORM_ACTIVATION` or `CUDNN_NORM_OPS_NORM_ADD_ACTIVATION` then this activation is used, otherwise the user may pass `NULL`.

***workspace, workSpaceSizeInBytes**

Inputs. `*workspace` is a pointer to the GPU workspace, and `workSpaceSizeInBytes` is the size of the workspace. When `*workspace` is not `NULL` and `*workSpaceSizeInBytes` is large enough, and the tensor layout is NHWC and the data type configuration is supported, then this function will trigger a semi-persistent NHWC kernel for normalization. The workspace is not required to be clean. Also, the workspace does not need to remain unchanged between the forward and backward passes.

***reserveSpace**

Input. Pointer to the GPU workspace for the `reserveSpace`.

reserveSpaceSizeInBytes

Input. The size of the `reserveSpace`. Must be equal or larger than the amount required by [cudaGetNormalizationTrainingReserveSpaceSize\(\)](#).

groutCnt

Input. Only support 1 for now.

Returns

CUDNN_STATUS_SUCCESS

The computation was performed successfully.

CUDNN_STATUS_NOT_SUPPORTED

The function does not support the provided configuration.

CUDNN_STATUS_BAD_PARAM

At least one of the following conditions are met:

- ▶ One of the pointers `alpha`, `beta`, `xData`, `yData`, `normScale`, and `normBias` is `NULL`.

- ▶ The number of xDesc or yDesc tensor descriptor dimensions is not within the [4,5] range (only 4D and 5D tensors are supported).
- ▶ normScaleBiasDesc dimensions are not 1xCx1x1 for 4D and 1xCx1x1x1 for 5D for per-channel mode, and are not 1xCxHxW for 4D and 1xCxDxHxW for 5D for per-activation mode.
- ▶ Exactly one of resultSaveMean, resultSaveInvVariance pointers are NULL.
- ▶ Exactly one of resultRunningMean, resultRunningInvVariance pointers are NULL.
- ▶ epsilon value is less than zero.
- ▶ Dimensions or data types mismatch for xDesc, yDesc.

4.1.17. cudnnOpsTrainVersionCheck()

```
cudaStatus_t cudnnOpsTrainVersionCheck(void)
```

This function checks whether the version of the OpsTrain subset of the library is consistent with the other sub-libraries.

Returns

CUDNN_STATUS_SUCCESS

The version is consistent with other sub-libraries.

CUDNN_STATUS_VERSION_MISMATCH

The version of OpsTrain is not consistent with other sub-libraries. Users should check the installation and make sure all sub-component versions are consistent.

4.1.18. cudnnPoolingBackward()

```
cudaStatus_t cudnnPoolingBackward(
    cudaHandle_t          handle,
    const cudaPoolingDescriptor_t poolingDesc,
    const void           *alpha,
    const cudaTensorDescriptor_t yDesc,
    const void           *y,
    const cudaTensorDescriptor_t dyDesc,
    const void           *dy,
    const cudaTensorDescriptor_t xDesc,
    const void           *xData,
    const void           *beta,
    const cudaTensorDescriptor_t dxDesc,
    void                 *dx)
```

This function computes the gradient of a pooling operation.

As of cuDNN version 6.0, a deterministic algorithm is implemented for max backwards pooling. This algorithm can be chosen via the pooling mode enum of poolingDesc. The deterministic algorithm has been measured to be up to 50% slower than the legacy max backwards pooling algorithm, or up to 20% faster, depending upon the use case.



Note: All tensor formats are supported, best performance is expected when using HW-packed tensors. Only 2 and 3 spatial dimensions are allowed

Parameters

handle

Input. Handle to a previously created cuDNN context.

poolingDesc

Input. Handle to the previously initialized pooling descriptor.

alpha, beta

Input. Pointers to scaling factors (in host memory) used to blend the computation result with prior value in the output layer as follows:

```
dstValue = alpha[0]*resultValue + beta[0]*priorDstValue
```

For more information, see [Scaling Parameters](#) in the *cuDNN Developer Guide*.

yDesc

Input. Handle to the previously initialized input tensor descriptor. Can be `NULL` for avg pooling.

y

Input. Data pointer to GPU memory associated with the tensor descriptor `yDesc`. Can be `NULL` for avg pooling.

dyDesc

Input. Handle to the previously initialized input differential tensor descriptor.

dy

Input. Data pointer to GPU memory associated with the tensor descriptor `dyData`.

xDesc

Input. Handle to the previously initialized output tensor descriptor. Can be `NULL` for avg pooling.

x

Input. Data pointer to GPU memory associated with the output tensor descriptor `xDesc`. Can be `NULL` for avg pooling.

dxDesc

Input. Handle to the previously initialized output differential tensor descriptor.

dx

Output. Data pointer to GPU memory associated with the output tensor descriptor `dxDesc`.

Returns

CUDNN_STATUS_SUCCESS

The function launched successfully.

CUDNN_STATUS_BAD_PARAM

At least one of the following conditions are met:

- ▶ The dimensions n, c, h, w of the yDesc and dyDesc tensors differ.
- ▶ The strides nStride, cStride, hStride, wStride of the yDesc and dyDesc tensors differ.
- ▶ The dimensions n, c, h, w of the dxDesc and dxDesc tensors differ.
- ▶ The strides nStride, cStride, hStride, wStride of the xDesc and dxDesc tensors differ.
- ▶ The datatype of the four tensors differ.

CUDNN_STATUS_NOT_SUPPORTED

The function does not support the provided configuration. See the following for some examples of non-supported configurations:

- ▶ The wStride of input tensor or output tensor is not 1.

CUDNN_STATUS_EXECUTION_FAILED

The function failed to launch on the GPU.

4.1.19. cudnnSoftmaxBackward()

```

cudnnStatus_t cudnnSoftmaxBackward(
    cudnnHandle_t          handle,
    cudnnSoftmaxAlgorithm_t algorithm,
    cudnnSoftmaxMode_t    mode,
    const void             *alpha,
    const cudnnTensorDescriptor_t yDesc,
    const void             *yData,
    const cudnnTensorDescriptor_t dyDesc,
    const void             *dy,
    const void             *beta,
    const cudnnTensorDescriptor_t dxDesc,
    void                  *dx)
    
```

This routine computes the gradient of the softmax function.

Note:

- ▶ In-place operation is allowed for this routine; meaning, dy and dx pointers may be equal. However, this requires dyDesc and dxDesc descriptors to be identical (particularly, the strides of the input and output must match for in-place operation to be allowed).
- ▶ All tensor formats are supported for all modes and algorithms with 4 and 5D tensors. Performance is expected to be highest with NCHW fully-packed tensors. For more than 5 dimensions tensors must be packed in their spatial dimensions.

Parameters

handle

Input. Handle to a previously created cuDNN context.

algorithm

Input. Enumerant to specify the softmax algorithm.

mode

Input. Enumerant to specify the softmax mode.

alpha, beta

Input. Pointers to scaling factors (in host memory) used to blend the computation result with prior value in the output layer as follows:

```
dstValue = alpha[0]*result + beta[0]*priorDstValue
```

For more information, see the [Scaling Parameters](#) section in the *cuDNN Developer Guide*.

yDesc

Input. Handle to the previously initialized input tensor descriptor.

y

Input. Data pointer to GPU memory associated with the tensor descriptor yDesc.

dyDesc

Input. Handle to the previously initialized input differential tensor descriptor.

dy

Input. Data pointer to GPU memory associated with the tensor descriptor dyData.

dxDesc

Input. Handle to the previously initialized output differential tensor descriptor.

dx

Output. Data pointer to GPU memory associated with the output tensor descriptor dxDesc.

Returns

CUDNN_STATUS_SUCCESS

The function launched successfully.

CUDNN_STATUS_NOT_SUPPORTED

The function does not support the provided configuration.

CUDNN_STATUS_BAD_PARAM

At least one of the following conditions are met:

- ▶ The dimensions n, c, h, w of the yDesc, dyDesc and dxDesc tensors differ.
- ▶ The strides nStride, cStride, hStride, wStride of the yDesc and dyDesc tensors differ.
- ▶ The datatype of the three tensors differs.

CUDNN_STATUS_EXECUTION_FAILED

The function failed to launch on the GPU.

4.1.20. cudnnSpatialTfGridGeneratorBackward()

```

cudnnStatus_t cudnnSpatialTfGridGeneratorBackward(
    cudnnHandle_t          handle,
    const cudnnSpatialTransformerDescriptor_t stDesc,
    const void             *dgrid,
    void                   *dtheta)
    
```

This function computes the gradient of a grid generation operation.

 **Note:** Only 2d transformation is supported.

Parameters

handle

Input. Handle to a previously created cuDNN context.

stDesc

Input. Previously created spatial transformer descriptor object.

dgrid

Input. Data pointer to GPU memory contains the input differential data.

dtheta

Output. Data pointer to GPU memory contains the output differential data.

Returns

CUDNN_STATUS_SUCCESS

The call was successful.

CUDNN_STATUS_BAD_PARAM

At least one of the following conditions are met:

- ▶ handle is NULL.
- ▶ One of the parameters dgrid or dtheta is NULL.

CUDNN_STATUS_NOT_SUPPORTED

The function does not support the provided configuration. See the following for some examples of non-supported configurations:

- ▶ The dimension of the transformed tensor specified in stDesc > 4.

CUDNN_STATUS_EXECUTION_FAILED

The function failed to launch on the GPU.

4.1.21. cudnnSpatialTfSamplerBackward()

```

cudnnStatus_t cudnnSpatialTfSamplerBackward(
    cudnnHandle_t          handle,
    const cudnnSpatialTransformerDescriptor_t stDesc,
    const void             *alpha,
    const cudnnTensorDescriptor_t xDesc,
    const void             *x,
    const void             *beta,
    const cudnnTensorDescriptor_t dxDesc,
    void                  *dx,
    const void             *alphaDgrid,
    const cudnnTensorDescriptor_t dyDesc,
    const void             *dy,
    const void             *grid,
    const void             *betaDgrid,
    void                  *dgrid)

```

This function computes the gradient of a sampling operation.



Note: Only 2d transformation is supported.

Parameters

handle

Input. Handle to a previously created cuDNN context.

stDesc

Input. Previously created spatial transformer descriptor object.

alpha, beta

Input. Pointers to scaling factors (in host memory) used to blend the source value with prior value in the destination tensor as follows:

$$\text{dstValue} = \text{alpha}[0] * \text{srcValue} + \text{beta}[0] * \text{priorDstValue}$$

For more information, see the [Scaling Parameters](#) section in the *cuDNN Developer Guide*.

xDesc

Input. Handle to the previously initialized input tensor descriptor.

x

Input. Data pointer to GPU memory associated with the tensor descriptor xDesc.

dxDesc

Input. Handle to the previously initialized output differential tensor descriptor.

dx

Output. Data pointer to GPU memory associated with the output tensor descriptor dxDesc.

alphaDgrid, betaDgrid

Input. Pointers to scaling factors (in host memory) used to blend the gradient outputs dgrid with prior value in the destination pointer as follows:

```
dstValue = alpha[0]*srcValue + beta[0]*priorDstValue
```

For more information, see the [Scaling Parameters](#) section in the *cuDNN Developer Guide*.

dyDesc

Input. Handle to the previously initialized input differential tensor descriptor.

dy

Input. Data pointer to GPU memory associated with the tensor descriptor dyDesc.

grid

Input. A grid of coordinates generated by [cudaSpatialTfGridGeneratorForward\(\)](#).

dgrid

Output. Data pointer to GPU memory contains the output differential data.

Returns

CUDNN_STATUS_SUCCESS

The call was successful.

CUDNN_STATUS_BAD_PARAM

At least one of the following conditions are met:

- ▶ handle is NULL.
- ▶ One of the parameters x, dx, y, dy, grid, dgrid is NULL.
- ▶ The dimension of dy differs from those specified in stDesc.

CUDNN_STATUS_NOT_SUPPORTED

The function does not support the provided configuration. See the following for some examples of non-supported configurations:

- ▶ The dimension of transformed tensor > 4.

CUDNN_STATUS_EXECUTION_FAILED

The function failed to launch on the GPU.

Chapter 5. `cuda_cnn_infer.so` Library

5.1. Data Type References

5.1.1. Pointer To Opaque Struct Types

5.1.1.1. `cudaConvolutionDescriptor_t`

`cudaConvolutionDescriptor_t` is a pointer to an opaque structure holding the description of a convolution operation. [`cudaCreateConvolutionDescriptor\(\)`](#) is used to create one instance, and [`cudaSetConvolutionNdDescriptor\(\)`](#) or [`cudaSetConvolution2dDescriptor\(\)`](#) must be used to initialize this instance.

5.1.2. Struct Types

5.1.2.1. `cudaConvolutionBwdDataAlgoPerf_t`

`cudaConvolutionBwdDataAlgoPerf_t` is a structure containing performance results returned by [`cudaFindConvolutionBackwardDataAlgorithm\(\)`](#) or heuristic results returned by [`cudaGetConvolutionBackwardDataAlgorithm_v7\(\)`](#).

Data Members

`cudaConvolutionBwdDataAlgo_t algo`

The algorithm runs to obtain the associated performance metrics.

`cudaStatus_t status`

If any error occurs during the workspace allocation or timing of [`cudaConvolutionBackwardData\(\)`](#), this status will represent that error. Otherwise, this status will be the return status of [`cudaConvolutionBackwardData\(\)`](#).

- ▶ CUDNN_STATUS_ALLOC_FAILED if any error occurred during workspace allocation or if the provided workspace is insufficient.
- ▶ CUDNN_STATUS_INTERNAL_ERROR if any error occurred during timing calculations or workspace deallocation.
- ▶ Otherwise, this will be the return status of [cudaConvolutionBackwardData\(\)](#).

float time

The execution time of [cudaConvolutionBackwardData\(\)](#) (in milliseconds).

size_t memory

The workspace size (in bytes).

cudaDeterminism_t determinism

The determinism of the algorithm.

cudaMathType_t mathType

The math type provided to the algorithm.

int reserved[3]

Reserved space for future properties.

5.1.2.2. **cudaConvolutionFwdAlgoPerf_t**

cudaConvolutionFwdAlgoPerf_t is a structure containing performance results returned by [cudaFindConvolutionForwardAlgorithm\(\)](#) or heuristic results returned by [cudaGetConvolutionForwardAlgorithm_v7\(\)](#).

Data Members

cudaConvolutionFwdAlgo_t algo

The algorithm runs to obtain the associated performance metrics.

cudaStatus_t status

If any error occurs during the workspace allocation or timing of [cudaConvolutionForward\(\)](#), this status will represent that error. Otherwise, this status will be the return status of [cudaConvolutionForward\(\)](#).

- ▶ CUDNN_STATUS_ALLOC_FAILED if any error occurred during workspace allocation or if the provided workspace is insufficient.
- ▶ CUDNN_STATUS_INTERNAL_ERROR if any error occurred during timing calculations or workspace deallocation.
- ▶ Otherwise, this will be the return status of [cudaConvolutionForward\(\)](#).

float time

The execution time of [cudaConvolutionForward\(\)](#) (in milliseconds).

size_t memory

The workspace size (in bytes).

cudaDeterminism_t determinism

The determinism of the algorithm.

cudaMathType_t mathType

The math type provided to the algorithm.

int reserved[3]

Reserved space for future properties.

5.1.3. Enumeration Types

5.1.3.1. cudaBackendAttributeName_t

cudaBackendAttributeName_t is an enumerated type that indicates the backend descriptor attributes that can be set or get via [cudaBackendSetAttribute\(\)](#) and [cudaBackendGetAttribute\(\)](#) functions. The backend descriptor to which an attribute belongs is identified by the prefix of the attribute name.

```
typedef enum {
    CUDA_ATTR_POINTWISE_MODE = 0,
    CUDA_ATTR_POINTWISE_MATH_PREC = 1,
    CUDA_ATTR_POINTWISE_NAN_PROPAGATION = 2,
    CUDA_ATTR_POINTWISE_RELU_LOWER_CLIP = 3,
    CUDA_ATTR_POINTWISE_RELU_UPPER_CLIP = 4,

    CUDA_ATTR_CONVOLUTION_COMP_TYPE = 100,
    CUDA_ATTR_CONVOLUTION_CONV_MODE = 101,
    CUDA_ATTR_CONVOLUTION_DILATIONS = 102,
    CUDA_ATTR_CONVOLUTION_FILTER_STRIDES = 103,
    CUDA_ATTR_CONVOLUTION_POST_PADDING = 104,
    CUDA_ATTR_CONVOLUTION_PRE_PADDING = 105,
    CUDA_ATTR_CONVOLUTION_SPATIAL_DIMS = 106,

    CUDA_ATTR_ENGINEHEUR_MODE = 200,
    CUDA_ATTR_ENGINEHEUR_OPERATION_GRAPH = 201,
    CUDA_ATTR_ENGINEHEUR_RESULTS = 202,

    CUDA_ATTR_ENGINECFG_ENGINE = 300,
    CUDA_ATTR_ENGINECFG_INTERMEDIATE_INFO = 301,
    CUDA_ATTR_ENGINECFG_KNOB_CHOICES = 302,

    CUDA_ATTR_EXECUTION_PLAN_HANDLE = 400,
    CUDA_ATTR_EXECUTION_PLAN_ENGINE_CONFIG = 401,
    CUDA_ATTR_EXECUTION_PLAN_WORKSPACE_SIZE = 402,
    CUDA_ATTR_EXECUTION_PLAN_COMPUTED_INTERMEDIATE_UIDS = 403,
    CUDA_ATTR_EXECUTION_PLAN_RUN_ONLY_INTERMEDIATE_UIDS = 404,

    CUDA_ATTR_INTERMEDIATE_INFO_UNIQUE_ID = 500,
    CUDA_ATTR_INTERMEDIATE_INFO_SIZE = 501,
    CUDA_ATTR_INTERMEDIATE_INFO_DEPENDENT_DATA_UIDS = 502,
    CUDA_ATTR_INTERMEDIATE_INFO_DEPENDENT_ATTRIBUTES = 503,

    CUDA_ATTR_KNOB_CHOICE_KNOB_TYPE = 600,
    CUDA_ATTR_KNOB_CHOICE_KNOB_VALUE = 601,

    CUDA_ATTR_OPERATION_CONVOLUTION_FORWARD_ALPHA = 700,
```

```

CUDNN_ATTR_OPERATION_CONVOLUTION_FORWARD_BETA = 701,
CUDNN_ATTR_OPERATION_CONVOLUTION_FORWARD_CONV_DESC = 702,
CUDNN_ATTR_OPERATION_CONVOLUTION_FORWARD_W = 703,
CUDNN_ATTR_OPERATION_CONVOLUTION_FORWARD_X = 704,
CUDNN_ATTR_OPERATION_CONVOLUTION_FORWARD_Y = 705,
CUDNN_ATTR_OPERATION_CONVOLUTION_BWD_DATA_ALPHA = 706,
CUDNN_ATTR_OPERATION_CONVOLUTION_BWD_DATA_BETA = 707,
CUDNN_ATTR_OPERATION_CONVOLUTION_BWD_DATA_CONV_DESC = 708,
CUDNN_ATTR_OPERATION_CONVOLUTION_BWD_DATA_W = 709,
CUDNN_ATTR_OPERATION_CONVOLUTION_BWD_DATA_DX = 710,
CUDNN_ATTR_OPERATION_CONVOLUTION_BWD_DATA_DY = 711,
CUDNN_ATTR_OPERATION_CONVOLUTION_BWD_FILTER_ALPHA = 712,
CUDNN_ATTR_OPERATION_CONVOLUTION_BWD_FILTER_BETA = 713,
CUDNN_ATTR_OPERATION_CONVOLUTION_BWD_FILTER_CONV_DESC = 714,
CUDNN_ATTR_OPERATION_CONVOLUTION_BWD_FILTER_DW = 715,
CUDNN_ATTR_OPERATION_CONVOLUTION_BWD_FILTER_X = 716,
CUDNN_ATTR_OPERATION_CONVOLUTION_BWD_FILTER_DY = 717,
CUDNN_ATTR_OPERATION_POINTWISE_PW_DESCRIPTOR = 750,
CUDNN_ATTR_OPERATION_POINTWISE_XDESC = 751,
CUDNN_ATTR_OPERATION_POINTWISE_BDESC = 752,
CUDNN_ATTR_OPERATION_POINTWISE_YDESC = 753,
CUDNN_ATTR_OPERATION_POINTWISE_ALPHA1 = 754,
CUDNN_ATTR_OPERATION_POINTWISE_ALPHA2 = 755,
CUDNN_ATTR_OPERATION_GENSTATS_MODE = 770,
CUDNN_ATTR_OPERATION_GENSTATS_MATH_PREC = 771,
CUDNN_ATTR_OPERATION_GENSTATS_XDESC = 772,
CUDNN_ATTR_OPERATION_GENSTATS_SUMDESC = 773,
CUDNN_ATTR_OPERATION_GENSTATS_SQSUMDESC = 774,

CUDNN_ATTR_OPERATIONGRAPH_HANDLE = 800,
CUDNN_ATTR_OPERATIONGRAPH_OPS = 801,
CUDNN_ATTR_OPERATIONGRAPH_ENGINE_GLOBAL_COUNT = 802,

CUDNN_ATTR_TENSOR_BYTE_ALIGNMENT = 900,
CUDNN_ATTR_TENSOR_DATA_TYPE = 901,
CUDNN_ATTR_TENSOR_DIMENSIONS = 902,
CUDNN_ATTR_TENSOR_STRIDES = 903,
CUDNN_ATTR_TENSOR_VECTOR_COUNT = 904,
CUDNN_ATTR_TENSOR_VECTORIZED_DIMENSION = 905,
CUDNN_ATTR_TENSOR_UNIQUE_ID = 906,
CUDNN_ATTR_TENSOR_IS_VIRTUAL = 907,

CUDNN_ATTR_VARIANT_PACK_UNIQUE_IDS = 1000,
CUDNN_ATTR_VARIANT_PACK_DATA_POINTERS = 1001,
CUDNN_ATTR_VARIANT_PACK_INTERMEDIATES = 1002,
CUDNN_ATTR_VARIANT_PACK_WORKSPACE = 1003,

CUDNN_ATTR_LAYOUT_INFO_TENSOR_UID = 1100,
CUDNN_ATTR_LAYOUT_INFO_TYPES = 1101,

CUDNN_ATTR_KNOB_INFO_TYPE = 1200,
CUDNN_ATTR_KNOB_INFO_MAXIMUM_VALUE = 1201,
CUDNN_ATTR_KNOB_INFO_MINIMUM_VALUE = 1202,
CUDNN_ATTR_KNOB_INFO_STRIDE = 1203,

CUDNN_ATTR_ENGINE_OPERATION_GRAPH = 1300,
CUDNN_ATTR_ENGINE_GLOBAL_INDEX = 1301,
CUDNN_ATTR_ENGINE_KNOB_INFO = 1302,
CUDNN_ATTR_ENGINE_NUMERICAL_NOTE = 1303,
CUDNN_ATTR_ENGINE_LAYOUT_INFO = 1304
} cudaBackendAttributeName_t;

```

Returns

The list of return values depends on the arguments used as explained in the [cuDNN Backend API](#).

5.1.3.2. cudnnBackendAttributeType_t

cudnnBackendAttributeType_t is an enumerated type that indicates type of backend descriptor attributes that can be set and get via [cudnnBackendSetAttribute\(\)](#) and [cudnnBackendGetAttribute\(\)](#) functions.

```
typedef enum {
    CUDNN_TYPE_HANDLE = 0,
    CUDNN_TYPE_DATA_TYPE,
    CUDNN_TYPE_BOOLEAN,
    CUDNN_TYPE_INT64,
    CUDNN_TYPE_FLOAT,
    CUDNN_TYPE_DOUBLE,
    CUDNN_TYPE_VOID_PTR,
    CUDNN_TYPE_CONVOLUTION_MODE,
    CUDNN_TYPE_HEUR_MODE,
    CUDNN_TYPE_KNOB_TYPE,
    CUDNN_TYPE_NAN_PROPOGATION,
    CUDNN_TYPE_NUMERICAL_NOTE,
    CUDNN_TYPE_LAYOUT_TYPE,
    CUDNN_TYPE_ATTRIB_NAME,
    CUDNN_TYPE_POINTWISE_MODE,
    CUDNN_TYPE_BACKEND_DESCRIPTOR,
    CUDNN_TYPE_GENSTATS_MODE
} cudnnBackendAttributeType_t;
```

Returns

The list of return values depends on the arguments used as explained in the [cuDNN Backend API](#), specifically, refer to [cudnnBackendAttributeType_t](#) for details.

5.1.3.3. cudnnBackendDescriptorType_t

cudnnBackendDescriptor_t is an enumerated type that indicates type of backend descriptors. Users create a backend descriptor of a particular type by passing a value from this enumerate to [cudnnBackendCreateDescriptor\(\)](#) function.

```
typedef enum {
    CUDNN_BACKEND_POINTWISE_DESCRIPTOR = 0,
    CUDNN_BACKEND_CONVOLUTION_DESCRIPTOR,
    CUDNN_BACKEND_ENGINE_DESCRIPTOR,
    CUDNN_BACKEND_ENGINECFG_DESCRIPTOR,
    CUDNN_BACKEND_ENGINEHEUR_DESCRIPTOR,
    CUDNN_BACKEND_EXECUTION_PLAN_DESCRIPTOR,
    CUDNN_BACKEND_INTERMEDIATE_INFO_DESCRIPTOR,
    CUDNN_BACKEND_KNOB_CHOICE_DESCRIPTOR,
    CUDNN_BACKEND_KNOB_INFO_DESCRIPTOR,
    CUDNN_BACKEND_LAYOUT_INFO_DESCRIPTOR,
    CUDNN_BACKEND_OPERATION_CONVOLUTION_FORWARD_DESCRIPTOR,
    CUDNN_BACKEND_OPERATION_CONVOLUTION_BACKWARD_FILTER_DESCRIPTOR,
    CUDNN_BACKEND_OPERATION_CONVOLUTION_BACKWARD_DATA_DESCRIPTOR,
    CUDNN_BACKEND_OPERATION_POINTWISE_DESCRIPTOR,
    CUDNN_BACKEND_OPERATION_GEN_STATS_DESCRIPTOR,
    CUDNN_BACKEND_OPERATIONGRAPH_DESCRIPTOR,
    CUDNN_BACKEND_VARIANT_PACK_DESCRIPTOR,
    CUDNN_BACKEND_TENSOR_DESCRIPTOR,
} cudnnBackendDescriptorType_t;
```

Returns

The list of return values depends on the arguments used as explained in the [cuDNN Backend API](#).

5.1.3.4. cudnnBackendHeurMode_t

cudnnBackendHeurMode_t is an enumerated type that indicates the operation mode of a CUDNN_BACKEND_ENGINE_HEUR_DESCRIPTOR.

```
typedef enum {
    CUDNN_HEUR_MODE_INSTANT = 0,
    CUDNN_HEUR_MODE_B      = 1
}
```

Values

CUDNN_HEUR_MODE_B

Can utilize Neural Net based heuristics to improve generalization performance compared to CUDNN_HEUR_MODE_INSTANT. In cases where the Neural Net is utilized, inference time on the CPU will be increased by 10-100x compared to CUDNN_HEUR_MODE_INSTANT. These Neural Net heuristics are not supported for any of the following cases:

- ▶ 3-D Convolutions
- ▶ Grouped Convolutions (groupCount larger than 1)
- ▶ Dilated Convolutions (any dilation for any spatial dimension larger than 1)

Further, the Neural Net is only enabled on x86 platforms when cuDNN is run on an A100 GPU. In cases where the Neural Net is not supported, CUDNN_HEUR_MODE_B will fall back to CUDNN_HEUR_MODE_INSTANT. CUDNN_HEUR_MODE_B will fall back to CUDNN_HEUR_MODE_INSTANT in cases where the overhead of CUDNN_HEUR_MODE_B is projected to reduce overall network performance.

5.1.3.5. cudnnBackendKnobType_t

cudnnBackendKnobType_t is an enumerated type that indicates the type of performance knobs. Performance knobs are runtime settings to an engine that will affect its performance. Users can query for an array of performance knobs and their valid value range from a CUDNN_BACKEND_ENGINE_DESCRIPTOR using [cudnnBackendGetAttribute\(\)](#) function. Users can set the choice for each knob using the [cudnnBackendSetAttribute\(\)](#) function with a CUDNN_BACKEND_KNOB_CHOICE_DESCRIPTOR descriptor.

```
typedef enum {
    CUDNN_KNOB_TYPE_SPLIT_K           = 0,
    CUDNN_KNOB_TYPE_SWIZZLE           = 1,
    CUDNN_KNOB_TYPE_TILE_SIZE         = 2,
    CUDNN_KNOB_TYPE_USE_TEX           = 3,
    CUDNN_KNOB_TYPE_EDGE              = 4,
    CUDNN_KNOB_TYPE_KBLOCK            = 5,
    CUDNN_KNOB_TYPE_LDGA              = 6,
    CUDNN_KNOB_TYPE_LDGB              = 7,
    CUDNN_KNOB_TYPE_CHUNK_K          = 8,
```

```

    CUDNN_KNOB_TYPE_SPLIT_H           = 9,
    CUDNN_KNOB_TYPE_WINO_TILE        = 10,
    CUDNN_KNOB_TYPE_MULTIPLY         = 11,
    CUDNN_KNOB_TYPE_SPLIT_K_BUF     = 12,
    CUDNN_KNOB_TYPE_TILEK           = 13,
    CUDNN_KNOB_TYPE_STAGES           = 14,
    CUDNN_KNOB_TYPE_REDUCTION_MODE   = 15,
    CUDNN_KNOB_TYPE_CTA_SPLIT_K_MODE = 16,
    CUDNN_KNOB_TYPE_SPLIT_K_SLC     = 17,
    CUDNN_KNOB_TYPE_IDX_MODE         = 18,
    CUDNN_KNOB_TYPE_SLICED           = 19,
    CUDNN_KNOB_TYPE_SPLIT_RS         = 20,
    CUDNN_KNOB_TYPE_SINGLEBUFFER     = 21,
    CUDNN_KNOB_TYPE_LDGC             = 22,
    CUDNN_KNOB_TYPE_SPECFILT        = 23,
    CUDNN_KNOB_TYPE_COUNTS           = 24,
} cudnnBackendKnobType_t;

```

5.1.3.6. cudnnBackendLayoutType_t

cudnnBackendLayoutType_t is an enumerated type that indicates queryable layout requirements of an engine. Users can query for layout requirements from a CUDNN_BACKEND_ENGINE_DESC descriptor using [cudnnBackendGetAttribute\(\)](#) function.

```

typedef enum {
    CUDNN_LAYOUT_TYPE_PREFERRED_NCHW = 0,
    CUDNN_LAYOUT_TYPE_PREFERRED_NHWC = 1,
    CUDNN_LAYOUT_TYPE_PREFERRED_PAD4CK = 2,
    CUDNN_LAYOUT_TYPE_PREFERRED_PAD8CK = 3,
    CUDNN_LAYOUT_TYPE_COUNT           = 4,
} cudnnBackendLayoutType_t;

```

5.1.3.7. cudnnBackendNumericalNote_t

cudnnBackendNumericalNote_t is an enumerated type that indicates queryable numerical properties of an engine. Users can query for an array of numerical notes from an CUDNN_BACKEND_ENGINE_DESC using [cudnnBackendGetAttribute\(\)](#) function.

```

typedef enum {
    CUDNN_NUMERICAL_NOTE_TENSOR_CORE = 0,
    CUDNN_NUMERICAL_NOTE_DOWN_CONVERT_INPUTS,
    CUDNN_NUMERICAL_NOTE_REDUCED_PRECISION_REDUCTION,
    CUDNN_NUMERICAL_NOTE_FFT,
    CUDNN_NUMERICAL_NOTE_NONDETERMINISTIC,
    CUDNN_NUMERICAL_NOTE_WINOGRAD,
    CUDNN_NUMERICAL_NOTE_TYPE_COUNT
} cudnnBackendNumericalNote_t;

```

5.1.3.8. cudnnConvolutionBwdDataAlgo_t

cudnnConvolutionBwdDataAlgo_t is an enumerated type that exposes the different algorithms available to execute the backward data convolution operation.

Values

CUDNN_CONVOLUTION_BWD_DATA_ALGO_0

This algorithm expresses the convolution as a sum of matrix products without actually explicitly forming the matrix that holds the input tensor data. The sum is done using the atomic add operation, thus the results are non-deterministic.

CUDNN_CONVOLUTION_BWD_DATA_ALGO_1

This algorithm expresses the convolution as a matrix product without actually explicitly forming the matrix that holds the input tensor data. The results are deterministic.

CUDNN_CONVOLUTION_BWD_DATA_ALGO_FFT

This algorithm uses a Fast-Fourier Transform approach to compute the convolution. A significant memory workspace is needed to store intermediate results. The results are deterministic.

CUDNN_CONVOLUTION_BWD_DATA_ALGO_FFT_TILING

This algorithm uses the Fast-Fourier Transform approach but splits the inputs into tiles. A significant memory workspace is needed to store intermediate results but less than CUDNN_CONVOLUTION_BWD_DATA_ALGO_FFT for large size images. The results are deterministic.

CUDNN_CONVOLUTION_BWD_DATA_ALGO_WINOGRAD

This algorithm uses the Winograd Transform approach to compute the convolution. A reasonably sized workspace is needed to store intermediate results. The results are deterministic.

CUDNN_CONVOLUTION_BWD_DATA_ALGO_WINOGRAD_NONFUSED

This algorithm uses the Winograd Transform approach to compute the convolution. A significant workspace may be needed to store intermediate results. The results are deterministic.

5.1.3.9. **cudnnConvolutionBwdFilterAlgo_t**

cudnnConvolutionBwdFilterAlgo_t is an enumerated type that exposes the different algorithms available to execute the backward filter convolution operation.

Values

CUDNN_CONVOLUTION_BWD_FILTER_ALGO_0

This algorithm expresses the convolution as a sum of matrix products without actually explicitly forming the matrix that holds the input tensor data. The sum is done using the atomic add operation, thus the results are non-deterministic.

CUDNN_CONVOLUTION_BWD_FILTER_ALGO_1

This algorithm expresses the convolution as a matrix product without actually explicitly forming the matrix that holds the input tensor data. The results are deterministic.

CUDNN_CONVOLUTION_BWD_FILTER_ALGO_FFT

This algorithm uses the Fast-Fourier Transform approach to compute the convolution. A significant workspace is needed to store intermediate results. The results are deterministic.

CUDNN_CONVOLUTION_BWD_FILTER_ALGO_3

This algorithm is similar to CUDNN_CONVOLUTION_BWD_FILTER_ALGO_0 but uses some small workspace to precompute some indices. The results are also non-deterministic.

CUDNN_CONVOLUTION_BWD_FILTER_WINOGRAD_NONFUSED

This algorithm uses the Winograd Transform approach to compute the convolution. A significant workspace may be needed to store intermediate results. The results are deterministic.

CUDNN_CONVOLUTION_BWD_FILTER_ALGO_FFT_TILING

This algorithm uses the Fast-Fourier Transform approach to compute the convolution but splits the input tensor into tiles. A significant workspace may be needed to store intermediate results. The results are deterministic.

5.1.3.10. cudnnConvolutionFwdAlgo_t

cudnnConvolutionFwdAlgo_t is an enumerated type that exposes the different algorithms available to execute the forward convolution operation.

Values

CUDNN_CONVOLUTION_FWD_ALGO_IMPLICIT_GEMM

This algorithm expresses the convolution as a matrix product without actually explicitly forming the matrix that holds the input tensor data.

CUDNN_CONVOLUTION_FWD_ALGO_IMPLICIT_PRECOMP_GEMM

This algorithm expresses convolution as a matrix product without actually explicitly forming the matrix that holds the input tensor data, but still needs some memory workspace to precompute some indices in order to facilitate the implicit construction of the matrix that holds the input tensor data.

CUDNN_CONVOLUTION_FWD_ALGO_GEMM

This algorithm expresses the convolution as an explicit matrix product. A significant memory workspace is needed to store the matrix that holds the input tensor data.

CUDNN_CONVOLUTION_FWD_ALGO_DIRECT

This algorithm expresses the convolution as a direct convolution (for example, without implicitly or explicitly doing a matrix multiplication).

CUDNN_CONVOLUTION_FWD_ALGO_FFT

This algorithm uses the Fast-Fourier Transform approach to compute the convolution. A significant memory workspace is needed to store intermediate results.

CUDNN_CONVOLUTION_FWD_ALGO_FFT_TILING

This algorithm uses the Fast-Fourier Transform approach but splits the inputs into tiles. A significant memory workspace is needed to store intermediate results but less than CUDNN_CONVOLUTION_FWD_ALGO_FFT for large size images.

CUDNN_CONVOLUTION_FWD_ALGO_WINOGRAD

This algorithm uses the Winograd Transform approach to compute the convolution. A reasonably sized workspace is needed to store intermediate results.

CUDNN_CONVOLUTION_FWD_ALGO_WINOGRAD_NONFUSED

This algorithm uses the Winograd Transform approach to compute the convolution. A significant workspace may be needed to store intermediate results.

5.1.3.11. cudnnConvolutionMode_t

cudnnConvolutionMode_t is an enumerated type used by [cudnnSetConvolution2dDescriptor\(\)](#) to configure a convolution descriptor. The filter used for the convolution can be applied in two different ways, corresponding mathematically to a convolution or to a cross-correlation. (A cross-correlation is equivalent to a convolution with its filter rotated by 180 degrees.)

Values**CUDNN_CONVOLUTION**

In this mode, a convolution operation will be done when applying the filter to the images.

CUDNN_CROSS_CORRELATION

In this mode, a cross-correlation operation will be done when applying the filter to the images.

5.1.3.12. cudnnGenStatsMode_t

cudnnGenStatsMode_t is an enumerated type to indicate the statistics mode in the backend statistics generation operation.

Values**CUDNN_GENSTATS_SUM_SQSUM**

In this mode, the sum and sum of squares of the input tensor along the specified dimensions are computed and written out. The reduction dimensions currently supported are limited per channel, however additional support may be added upon request.

5.1.3.13. cudnnPointwiseMode_t

cudnnPointwiseMode_t is an enumerated type to indicate the intended pointwise math operation in the backend pointwise operation descriptor.

Values

CUDNN_POINTWISE_ADD

In this mode, a pointwise add between two tensors is computed.

CUDNN_POINTWISE_MUL

In this mode, a pointwise multiplication between two tensors is computed.

CUDNN_POINTWISE_MIN

In this mode, a pointwise minimum is taken between two tensors.

CUDNN_POINTWISE_MAX

In this mode, a pointwise max is taken between two tensors.

CUDNN_POINTWISE_SQRT

In this mode, a pointwise square root of the input tensor is computed.

CUDNN_POINTWISE_IDENTITY_FWD

In this mode, an identity activation (pointwise value copy) is performed.

CUDNN_POINTWISE_RELU_FWD

In this mode, a pointwise ReLu activation is computed.

CUDNN_POINTWISE_TANH_FWD

In this mode, a pointwise tanh activation is computed.

CUDNN_POINTWISE_SIGMOID_FWD

In this mode, a pointwise sigmoid activation is computed.

CUDNN_POINTWISE_ELU_FWD

In this mode, a pointwise Exponential Linear Unit activation is computed.

5.1.3.14. cudnnReorderType_t

```
typedef enum {
    CUDNN_DEFAULT_REORDER = 0,
    CUDNN_NO_REORDER      = 1,
} cudnnReorderType_t;
```

`cudnnReorderType_t` is an enumerated type to set the convolution reordering type. The reordering type can be set by `cudnnSetConvolutionReorderType()` and its status can be read by `cudnnGetConvolutionReorderType()`.

5.1.4. Data Types Found In `cudnn_backend.h`

5.1.4.1. cudnnBackendDescriptor_t

`cudaBackendDescriptor_t` is a typedef void pointer to one of many opaque descriptor structures. The type of structure that it points to is determined by the argument when allocating the memory for the opaque structure using [cudaBackendCreateDescriptor\(\)](#).

Attributes of a descriptor can be set using [cudaBackendSetAttribute\(\)](#). After all required attributes of a descriptor are set, the descriptor can be finalized by [cudaBackendFinalizeDescriptor\(\)](#). From a finalized descriptor, one can query its queryable attributes using [cudaBackendGetAttribute\(\)](#). Finally, the memory allocated for a descriptor can be freed using [cudaBackendDestroyDescriptor\(\)](#).

5.2. API Functions

5.2.1. `cudaBackendCreateDescriptor()`

```
cudaStatus_t cudaBackendCreateDescriptor(cudaBackendDescriptorType_t descriptorType, cudaBackendDescriptor_t *descriptor)
```

This function allocates memory:

- ▶ in the descriptor for a given descriptor type
- ▶ at the location pointed by the descriptor



Note: The void * is a pointer to the `cudaBackend_t`.

Parameters

descriptorType

Input. One among the enumerated [cudaBackendDescriptorType_t](#).

descriptor

Input. Pointer to an instance of [cudaBackendDescriptor_t](#) to be created.

Returns

CUDNN_STATUS_SUCCESS

The creation was successful.

CUDNN_STATUS_NOT_SUPPORTED

Creating a descriptor of a given type is not supported.

CUDNN_STATUS_ALLOC_FAILED

The memory allocation failed.

Additional return values depend on the arguments used as explained in the [cuDNN Backend API](#).

5.2.2. cudnnBackendDestroyDescriptor()

```
cudaStatus_t cudnnBackendDestroyDescriptor(cudaBackendDescriptor_t descriptor)
```

This function destroys instances of [cudnnBackendDescriptor_t](#) that were previously created using [cudnnBackendCreateDescriptor\(\)](#).

Parameters

descriptor

Input. Instance of [cudnnBackendDescriptor_t](#) previously created by [cudnnBackendCreateDescriptor\(\)](#).

Returns

CUDNN_STATUS_SUCCESS

The memory was destroyed successfully.

CUDNN_STATUS_ALLOC_FAILED

The destruction of memory failed.

Undefined Behavior

The descriptor was altered between the Create and Destroy Descriptor.

Undefined

The value pointed by the descriptor will be Undefined after the memory is free and done.

Additional return values depend on the arguments used as explained in the [cuDNN Backend API](#).

5.2.3. cudnnBackendExecute()

```
cudaStatus_t cudnnBackendExecute(cudaHandle_t handle, cudaBackendDescriptor_t executionPlan, cudaBackendDescriptor_t variantPack)
```

This function executes:

- ▶ the given Engine Configuration Plan on the VariantPack
- ▶ the finalized ExecutionPlan on the data

The data and the working space are encapsulated in the VariantPack.

Parameters

executionPlan

Input. Pointer to the cuDNN handle to be destroyed.

variantPack

Input. Pointer to the finalized variantPack consisting of:

- ▶ Data pointer for each non-virtual pointer of the operation set in the execution plan.
- ▶ Pointer to user-allocated workspace in global memory at least as large as the size queried from CUDNN_BACKEND_.

Returns

CUDNN_STATUS_SUCCESS

The ExecutionPlan was executed successfully.

CUDNN_STATUS_BAD_PARAM

An incorrect or inconsistent value is encountered. Some examples:

- ▶ A required data pointer is invalid.

CUDNN_STATUS_INTERNAL_ERROR

Some internal errors were encountered.

CUDNN_STATUS_EXECUTION_FAILED

An error was encountered executing the plan with the variant pack.

Additional return values depend on the arguments used as explained in the [cuDNN Backend API](#).

5.2.4. cudnnBackendFinalize()

```
cudaStatus_t cudnnBackendFinalize(cudaBackendDescriptor descriptor)
```

This function finalizes the memory pointed to by the `descriptor`. The type of finalization is done depending on the `descriptorType` argument with which the `descriptor` was created using [cudnnBackendCreate\(\)](#) or initialized using [cudnnBackendInitialize\(\)](#).

`cudnnBackendFinalize()` also checks all the attributes set between the create/initialization and finalize phase. If successful, `cudnnBackendFinalize()` returns `CUDNN_STATUS_SUCCESS` and the finalized state of the `descriptor` is set to `true`. In this state, setting attributes using [cudnnBackendSetAttribute\(\)](#) is not allowed. Getting attributes using [cudnnBackendGetAttribute\(\)](#) is only allowed when the finalized state of the `descriptor` is `true`.

Parameters

descriptor

Input. Instance of [cudaBackendDescriptor_t](#) to finalize.

Returns

CUDNN_STATUS_SUCCESS

The `descriptor` was finalized successfully.

CUDNN_STATUS_BAD_PARAM

Invalid `descriptor` attribute values or combination thereof is encountered.

CUDNN_STATUS_NOT_SUPPORTED

Descriptor attribute values or combinations therefore not supported by the current version of cuDNN is encountered.

CUDNN_STATUS_INTERNAL_ERROR

Some internal errors are encountered.

Additional return values depend on the arguments used as explained in the [cuDNN Backend API](#).

5.2.5. `cudnnBackendGetAttribute()`

```

cudnnStatus_t cudnnBackendGetAttribute(
    cudnnBackendDescriptor_t descriptor,
    cudnnBackendAttributeName_t attributeName,
    cudnnBackendAttributeType_t attributeType,
    int64_t requestedElementCount,
    int64_t *elementCount,
    void *arrayOfElements);

```

This function retrieves the value(s) of an attribute of a descriptor. `attributeName` is the name of the attribute whose value is requested. The `attributeType` is the type of attribute. `requestsedElementCount` is the number of elements to be potentially retrieved. The number of elements for the requested attribute is stored in `elementCount`. The retrieved values are stored in `arrayOfElements`. When the attribute is expected to have a single value, `arrayOfElements` can be pointer to the output value. This function will return `CUDNN_STATUS_NOT_INITIALIZED` if the descriptor was already successfully finalized.

Parameters

descriptor

Input. Instance of [cudnnBackendDescriptor_t](#) whose attribute the user wants to retrieve.

attributeName

Input. The name of the attribute being get from the on the descriptor.

attributeType

Input. The type of attribute.

requestedElementCount

Input. Number of elements to output to `arrayOfElements`.

elementCount

Input. Output pointer for the number of elements the descriptor attribute has. Note that `cudnnBackendGetAttribute()` will only write the least of this and `requestedElementCount` elements to `arrayOfElements`.

arrayOfElements

Input. Output pointer to element of attribute type.

Returns

CUDNN_STATUS_SUCCESS

The `attributeName` was given to the `descriptor` successfully.

CUDNN_STATUS_BAD_PARAM

One or more invalid or inconsistent argument values was encountered. Some examples:

- ▶ `attributeName` is not a valid attribute for the descriptor.
- ▶ `attributeType` is not one of the valid types for the attribute.

CUDNN_STATUS_NOT_INITIALIZED

The `descriptor` has not been successfully finalized using `cudaBackendFinalize()`.

Additional return values depend on the arguments used as explained in the [cuDNN Backend API](#).

5.2.6. `cudaBackendInitialize()`

```
cudaStatus_t cudaBackendInitialize(cudaBackendDescriptor_t descriptor,
    cudaBackendDescriptorType_t descriptorType, size_t sizeInBytes)
```

This function repurposes a pre-allocated memory pointed to by a descriptor of size `sizeInByte` to a backend descriptor of type `descriptorType`. The necessary size for a descriptor type can be acquired by calling the function `cudaBackendGetSizeOf()`. The finalized state of the descriptor is set to `false`.

Parameters

descriptor

Input. Instance of `cudaBackendDescriptor_t` to be initialized.

descriptorType

Input. Enumerated value for the type of cuDNN backend descriptor.

sizeInBytes

Input. Size of memory pointed to by `descriptor`.

Returns

CUDNN_STATUS_SUCCESS

The memory was initialized successfully.

CUDNN_STATUS_BAD_PARAM

An invalid or inconsistent argument value is encountered. For example:

- ▶ descriptor is a nullptr
- ▶ sizeInBytes is less than the size required by the descriptor type

Additional return values depend on the arguments used as explained in the [cuDNN Backend API](#).

5.2.7. cudnnBackendSetAttribute ()

```

cudnnStatus_t cudnnBackendSetAttribute(
    cudnnBackendDescriptor_t descriptor,
    cudnnBackendAttributeName_t attributeName,
    cudnnBackendAttributeType_t attributeType,
    int64_t elementCount,
    void *arrayOfElements);
    
```

This function sets an attribute of a descriptor to value(s) provided as a pointer. descriptor is the descriptor to be set. attributeName is the name of the attribute to be set. attributeType is the type of attribute. The value to which the attribute is set, is pointed by the arrayOfElements. The number of elements is given by elementCount. This function will return CUDNN_STATUS_NOT_INITIALIZED if the descriptor is already successfully finalized using [cudnnBackendFinalize\(\)](#).

Parameters

descriptor

Input. Instance of [cudnnBackendDescriptor_t](#) whose attribute is being set.

attributeName

Input. The name of the attribute being set on the descriptor.

attributeType

Input. The type of attribute.

elementCount

Input. Number of elements being set.

arrayOfElements

Input. The starting location for an array from where to read the values from.

Returns

CUDNN_STATUS_SUCCESS

The attributeName was set to the descriptor.

CUDNN_STATUS_NOT_INITIALIZED

The backend descriptor pointed to by descriptor is already in finalized state.

CUDNN_STATUS_BAD_PARAM

The function is called with arguments that correspond to invalid values. Some possible causes are:

- ▶ attributeName is not a settable attribute of descriptor
- ▶ attributeType is incorrect for this attributeName.
- ▶ elemCount value is unexpected.
- ▶ arrayOfElements contains values invalid for the attributeType.

CUDNN_STATUS_NOT_SUPPORTED

The value(s) to which the attributes are being set is not supported by the current version of cuDNN.

Additional return values depend on the arguments used as explained in the [cuDNN Backend API](#).

5.2.8. cudnnConvolutionBackwardData ()

```

cudnnStatus_t cudnnConvolutionBackwardData (
    cudnnHandle_t          handle,
    const void             *alpha,
    const cudnnFilterDescriptor_t wDesc,
    const void             *w,
    const cudnnTensorDescriptor_t dyDesc,
    const void             *dy,
    const cudnnConvolutionDescriptor_t convDesc,
    cudnnConvolutionBwdDataAlgo_t algo,
    void                   *workSpace,
    size_t                 workSpaceSizeInBytes,
    const void             *beta,
    const cudnnTensorDescriptor_t dxDesc,
    void                   *dx)
    
```

This function computes the convolution data gradient of the tensor dy, where y is the output of the forward convolution in [cudnnConvolutionForward\(\)](#). It uses the specified algo, and returns the results in the output tensor dx. Scaling factors alpha and beta can be used to scale the computed result or accumulate with the current dx.

Parameters

handle

Input. Handle to a previously created cuDNN context. For more information, see [cudnnHandle_t](#).

alpha, beta

Input. Pointers to scaling factors (in host memory) used to blend the computation result with prior value in the output layer as follows:

```
dstValue = alpha[0]*result + beta[0]*priorDstValue
```

For more information, see [Scaling Parameters](#) in the *cuDNN Developer Guide*.

wDesc

Input. Handle to a previously initialized filter descriptor. For more information, see [cudnnFilterDescriptor_t](#).

w

Input. Data pointer to GPU memory associated with the filter descriptor `wDesc`.

dyDesc

Input. Handle to the previously initialized input differential tensor descriptor. For more information, see [cudaTensorDescriptor_t](#).

dy

Input. Data pointer to GPU memory associated with the input differential tensor descriptor `dyDesc`.

convDesc

Input. Previously initialized convolution descriptor. For more information, see [cudaConvolutionDescriptor_t](#).

algo

Input. Enumerant that specifies which backward data convolution algorithm should be used to compute the results. For more information, see [cudaConvolutionBwdDataAlgo_t](#).

workSpace

Input. Data pointer to GPU memory to a workspace needed to be able to execute the specified algorithm. If no workspace is needed for a particular algorithm, that pointer can be nil.

workSpaceSizeInBytes

Input. Specifies the size in bytes of the provided `workSpace`.

dxDesc

Input. Handle to the previously initialized output tensor descriptor.

dx

Input/Output. Data pointer to GPU memory associated with the output tensor descriptor `dxDesc` that carries the result.

Supported configurations

This function supports the following combinations of data types for `wDesc`, `dyDesc`, `convDesc`, and `dxDesc`.

Data Type Configurations	wDesc, dyDesc and dxDesc Data Type	convDesc Data Type
TRUE_HALF_CONFIG (only supported on architectures with true FP16 support, meaning, compute capability 5.3 and later)	CUDA_DATA_HALF	CUDA_DATA_HALF

Data Type Configurations	wDesc, dyDesc and dxDesc Data Type	convDesc Data Type
PSEUDO_HALF_CONFIG	CUDNN_DATA_HALF	CUDNN_DATA_FLOAT
PSEUDO_BFLOAT16_CONFIG	CUDNN_DATA_BFLOAT16	CUDNN_DATA_FLOAT
FLOAT_CONFIG	CUDNN_DATA_FLOAT	CUDNN_DATA_FLOAT
DOUBLE_CONFIG	CUDNN_DATA_DOUBLE	CUDNN_DATA_DOUBLE

Supported algorithms

Note: Specifying a separate algorithm can cause changes in performance, support and computation determinism. See the following for a list of algorithm options, and their respective supported parameters and deterministic behavior.

The table below shows the list of the supported 2D and 3D convolutions. The 2D convolutions are described first, followed by the 3D convolutions.

For the following terms, the short-form versions shown in the parentheses are used in the table below, for brevity:

- ▶ CUDNN_CONVOLUTION_BWD_DATA_ALGO_0 (**_ALGO_0**)
- ▶ CUDNN_CONVOLUTION_BWD_DATA_ALGO_1 (**_ALGO_1**)
- ▶ CUDNN_CONVOLUTION_BWD_DATA_ALGO_FFT (**_FFT**)
- ▶ CUDNN_CONVOLUTION_BWD_DATA_ALGO_FFT_TILING (**_FFT_TILING**)
- ▶ CUDNN_CONVOLUTION_BWD_DATA_ALGO_WINOGRAD (**_WINOGRAD**)
- ▶ CUDNN_CONVOLUTION_BWD_DATA_ALGO_WINOGRAD_NONFUSED (**_WINOGRAD_NONFUSED**)
- ▶ CUDNN_TENSOR_NCHW (**_NCHW**)
- ▶ CUDNN_TENSOR_NHWC (**_NHWC**)
- ▶ CUDNN_TENSOR_NCHW_VECT_C (**_NCHW_VECT_C**)

Table 13. For 2D convolutions: wDesc: `_NHWC`

Filter descriptor wDesc: <code>_NHWC</code> (see cudnnTensorFormat_t)					
Algo Name	Deterministic (Yes or No)	Tensor Formats Supported for dyDesc	Tensor Formats Supported for dxDesc	Data Type Configurations Supported	Important
<code>_ALGO_0</code>		NHWC HWC-packed	NHWC HWC-packed	TRUE_HALF_CONFIG	
<code>_ALGO_1</code>				PSEUDO_HALF_CONFIG	
				PSEUDO_BFLOAT16_CONFIG	

Filter descriptor $wDesc$: <code>_NHWC</code> (see cudnnTensorFormat_t)					
Algo Name	Deterministic (Yes or No)	Tensor Formats Supported for $dyDesc$	Tensor Formats Supported for $dxDesc$	Data Type Configurations Supported	Important
				FLOAT_CONFIG	

Table 14. For 2D convolutions: $wDesc$: `_NCHW`

Filter descriptor $wDesc$: <code>_NCHW</code> .					
Algo Name	Deterministic (Yes or No)	Tensor Formats Supported for $dyDesc$	Tensor Formats Supported for $dxDesc$	Data Type Configurations Supported	Important
<code>_ALGO_0</code>	No	NCHW CHW-packed	All except <code>_NCHW_VECT_C</code> .	TRUE_HALF_CONFIG PSEUDO_HALF_CONFIG PSEUDO_BFLOAT16_CONFIG FLOAT_CONFIG DOUBLE_CONFIG	Dilation: greater than 0 for all dimensions convDesc Group Count Support: Greater than 0
<code>_ALGO_1</code>	Yes	NCHW CHW-packed	All except <code>_NCHW_VECT_C</code> .	TRUE_HALF_CONFIG PSEUDO_HALF_CONFIG PSEUDO_BFLOAT16_CONFIG FLOAT_CONFIG DOUBLE_CONFIG	Dilation: greater than 0 for all dimensions convDesc Group Count Support: Greater than 0
<code>_FFT</code>	Yes	NCHW CHW-packed	NCHW HW-packed	PSEUDO_HALF_CONFIG FLOAT_CONFIG	Dilation: 1 for all dimensions convDesc Group Count Support: Greater than 0 $dxDesc$ feature map height + $2 * convDesc$

Filter descriptor <code>wDesc: _NCHW</code> .					
Algo Name	Deterministic (Yes or No)	Tensor Formats Supported for <code>dyDesc</code>	Tensor Formats Supported for <code>dxDesc</code>	Data Type Configurations Supported	Important
					zero-padding height must equal 256 or less <code>dxDesc</code> feature map width + 2 * <code>convDesc</code> zero-padding width must equal 256 or less <code>convDesc</code> vertical and horizontal filter stride must equal 1 <code>wDesc</code> filter height must be greater than <code>convDesc</code> zero-padding height <code>wDesc</code> filter width must be greater than <code>convDesc</code> zero-padding width
<code>_FFT_TILING</code>	Yes	NCHW CHW-packed	NCHW HW-packed	<code>PSEUDO_HALF_CONFIG</code> <code>FLOAT_CONFIG</code> <code>DOUBLE_CONFIG</code> is also supported when the task can be handled	Dilation: 1 for all dimensions <code>convDesc</code> Group Count Support: Greater than 0

Filter descriptor $wDesc$: <code>_NCHW</code> .					
Algo Name	Deterministic (Yes or No)	Tensor Formats Supported for $dyDesc$	Tensor Formats Supported for $dxDesc$	Data Type Configurations Supported	Important
				by 1D FFT, meaning, one of the filter dimensions, width or height is 1.	<p>When neither of $wDesc$ filter dimension is 1, the filter width and height must not be larger than 32</p> <p>When either of $wDesc$ filter dimension is 1, the largest filter dimension should not exceed 256</p> <p>$convDesc$ vertical and horizontal filter stride must equal 1 when either the filter width or filter height is 1, otherwise, the stride can be 1 or 2</p> <p>$wDesc$ filter height must be greater than $convDesc$ zero-padding height</p> <p>$wDesc$ filter width must be greater than $convDesc$</p>

Filter descriptor $wDesc$: <code>_NCHW</code> .					
Algo Name	Deterministic (Yes or No)	Tensor Formats Supported for $dyDesc$	Tensor Formats Supported for $dxDesc$	Data Type Configurations Supported	Important
					zero-padding width
<code>_WINOGRAD</code>	Yes	NCHW CHW-packed	All except <code>_NCHW_VECT_C</code> .	<code>PSEUDO_HALF_CONFIG</code> <code>FLOAT_CONFIG</code>	Dilation: 1 for all dimensions $convDesc$ Group Count Support: Greater than 0 $convDesc$ vertical and horizontal filter stride must equal 1 $wDesc$ filter height must be 3 $wDesc$ filter width must be 3
<code>_WINOGRAD_NONP</code>	Yes	NCHW CHW-packed	All except <code>_NCHW_VECT_C</code> .	<code>TRUE_HALF_CONFIG</code> <code>PSEUDO_HALF_CONFIG</code> <code>PSEUDO_BFLOAT16_CONFIG</code> <code>FLOAT_CONFIG</code>	Dilation: 1 for all dimensions $convDesc$ Group Count Support: Greater than 0 $convDesc$ vertical and horizontal filter stride must equal 1 $wDesc$ filter (height, width) must be (3,3) or (5,5)

Filter descriptor <code>wDesc: _NCHW</code> .					
Algo Name	Deterministic (Yes or No)	Tensor Formats Supported for <code>dyDesc</code>	Tensor Formats Supported for <code>dxDesc</code>	Data Type Configurations Supported	Important
					If <code>wDesc</code> filter (height, width) is (5,5) then the data type config <code>TRUE_HALF_CONFIG</code> is not supported

Table 15. For 3D convolutions: `wDesc: _NCHW`

Filter descriptor <code>wDesc: _NCHW</code> .					
Algo Name	Deterministic (Yes or No)	Tensor Formats Supported for <code>dyDesc</code>	Tensor Formats Supported for <code>dxDesc</code>	Data Type Configurations Supported	Important
<code>_ALGO_0</code>	Yes	NCDHW CDHW-packed	All except <code>_NCDHW_VECT_C</code>	<code>PSEUDO_HALF_CONFIG</code> <code>PSEUDO_BFLOAT16_CONFIG</code> <code>FLOAT_CONFIG</code> <code>DOUBLE_CONFIG</code>	Dilation: greater than 0 for all dimensions <code>convDesc</code> Group Count Support: Greater than 0
<code>_ALGO_1</code>	Yes	NCDHW CDHW-packed	NCDHW CDHW-packed	<code>TRUE_HALF_CONFIG</code> <code>PSEUDO_BFLOAT16_CONFIG</code> <code>PSEUDO_HALF_CONFIG</code> <code>FLOAT_CONFIG</code> <code>DOUBLE_CONFIG</code>	Dilation: 1 for all dimensions <code>convDesc</code> Group Count Support: Greater than 0
<code>_FFT_TILING</code>	Yes	NCDHW CDHW-packed	NCDHW DHW-packed	<code>PSEUDO_HALF_CONFIG</code> <code>FLOAT_CONFIG</code> <code>DOUBLE_CONFIG</code>	Dilation: 1 for all dimensions <code>convDesc</code> Group Count

Filter descriptor <code>wDesc: _NCHW</code> .					
Algo Name	Deterministic (Yes or No)	Tensor Formats Supported for <code>dyDesc</code>	Tensor Formats Supported for <code>dxDesc</code>	Data Type Configurations Supported	Important
					Support: Greater than 0 <code>wDesc</code> filter height must equal 16 or less <code>wDesc</code> filter width must equal 16 or less <code>wDesc</code> filter depth must equal 16 or less <code>convDesc</code> must have all filter strides equal to 1 <code>wDesc</code> filter height must be greater than <code>convDesc</code> zero-padding height <code>wDesc</code> filter width must be greater than <code>convDesc</code> zero-padding width <code>wDesc</code> filter depth must be greater than <code>convDesc</code>

Filter descriptor <code>wDesc: _NCHW</code>					
Algo Name	Deterministic (Yes or No)	Tensor Formats Supported for <code>dyDesc</code>	Tensor Formats Supported for <code>dxDesc</code>	Data Type Configurations Supported	Important
					zero-padding width

Table 16. For 3D convolutions: `wDesc: _NHWC`

Filter descriptor <code>wDesc: _NHWC</code>					
Algo Name (3D Convolutions)	Deterministic (Yes or No)	Tensor Formats Supported for <code>dyDesc</code>	Tensor Formats Supported for <code>dxDesc</code>	Data Type Configurations Supported	Important
<code>_ALGO_1</code>	Yes	NDHWC DHWC-packed	NDHWC DHWC-packed	TRUE_HALF_CONFIG PSEUDO_HALF_CONFIG PESUDO_BFLOAT16_CONFIG FLOAT_CONFIG	Dilation: Greater than 0 for all dimensions convDesc Group Count Support: Greater than 0

Returns

CUDNN_STATUS_SUCCESS

The operation was launched successfully.

CUDNN_STATUS_BAD_PARAM

At least one of the following conditions are met:

- ▶ At least one of the following is NULL: `handle`, `dyDesc`, `wDesc`, `convDesc`, `dxDesc`, `dy`, `w`, `dx`, `alpha`, `beta`
- ▶ `wDesc` and `dyDesc` have a non-matching number of dimensions
- ▶ `wDesc` and `dxDesc` have a non-matching number of dimensions
- ▶ `wDesc` has fewer than three number of dimensions
- ▶ `wDesc`, `dxDesc`, and `dyDesc` have a non-matching data type.
- ▶ `wDesc` and `dxDesc` have a non-matching number of input feature maps per image (or group in case of grouped convolutions).

- ▶ dyDesc spatial sizes do not match with the expected size as determined by `cudaGetConvolutionNdForwardOutputDim`

CUDNN_STATUS_NOT_SUPPORTED

At least one of the following conditions are met:

- ▶ dyDesc or dxDesc have a negative tensor striding
- ▶ dyDesc, wDesc or dxDesc has a number of dimensions that is not 4 or 5
- ▶ The chosen algo does not support the parameters provided; see above for an exhaustive list of parameters that support each algo
- ▶ dyDesc or wDesc indicate an output channel count that isn't a multiple of group count (if group count has been set in convDesc).

CUDNN_STATUS_MAPPING_ERROR

An error occurs during the texture binding of texture object creation associated with the filter data or the input differential tensor data.

CUDNN_STATUS_EXECUTION_FAILED

The function failed to launch on the GPU.

5.2.9. `cudaConvolutionBiasActivationForward()`

```

cudaStatus_t cudaConvolutionBiasActivationForward(
    cudaHandle_t          handle,
    const void            *alpha1,
    const cudaTensorDescriptor_t xDesc,
    const void            *x,
    const cudaFilterDescriptor_t wDesc,
    const void            *w,
    const cudaConvolutionDescriptor_t convDesc,
    cudaConvolutionFwdAlgo_t algo,
    void                  *workspace,
    size_t                workspaceSizeInBytes,
    const void            *alpha2,
    const cudaTensorDescriptor_t zDesc,
    const void            *z,
    const cudaTensorDescriptor_t biasDesc,
    const void            *bias,
    const cudaActivationDescriptor_t activationDesc,
    const cudaTensorDescriptor_t yDesc,
    void                  *y)

```

This function applies a bias and then an activation to the convolutions or cross-correlations of `cudaConvolutionForward()`, returning results in `y`. The full computation follows the equation `y = act (alpha1 * conv(x) + alpha2 * z + bias)`.

Note:

- ▶ The routine `cudaGetConvolution2dForwardOutputDim()` or `cudaGetConvolutionNdForwardOutputDim()` can be used to determine the proper dimensions of the output tensor descriptor `yDesc` with respect to `xDesc`, `convDesc`, and `wDesc`.
- ▶ Only the `CUDNN_CONVOLUTION_FWD_ALGO_IMPLICIT_PRECOMP_GEMM` algo is enabled with `CUDNN_ACTIVATION_IDENTITY`. In other words, in the `cudaActivationDescriptor_t`

structure of the input `activationDesc`, if the mode of the `cudaActivationMode_t` field is set to the enum value `CUDNN_ACTIVATION_IDENTITY`, then the input `cudaConvolutionFwdAlgo_t` of this function `cudaConvolutionBiasActivationForward()` must be set to the enum value `CUDNN_CONVOLUTION_FWD_ALGO_IMPLICIT_PRECOMP_GEMM`. For more information, see `cudaSetActivationDescriptor()`.

- ▶ Device pointer `z` and `y` may be pointing to the same buffer, however, `x` cannot point to the same buffer as `z` or `y`.

Parameters

handle

Input. Handle to a previously created cuDNN context. For more information, see [cudaHandle_t](#).

alpha1, alpha2

Input. Pointers to scaling factors (in host memory) used to blend the computation result of convolution with `z` and bias as follows:

$$y = \text{act} (\text{alpha1} * \text{conv}(x) + \text{alpha2} * z + \text{bias})$$

For more information, see [Scaling Parameters](#) in the *cuDNN Developer Guide*.

xDesc

Input. Handle to a previously initialized tensor descriptor. For more information, see [cudaTensorDescriptor_t](#).

x

Input. Data pointer to GPU memory associated with the tensor descriptor `xDesc`.

wDesc

Input. Handle to a previously initialized filter descriptor. For more information, see [cudaFilterDescriptor_t](#).

w

Input. Data pointer to GPU memory associated with the filter descriptor `wDesc`.

convDesc

Input. Previously initialized convolution descriptor. For more information, see [cudaConvolutionDescriptor_t](#).

algo

Input. Enumerant that specifies which convolution algorithm should be used to compute the results. For more information, see [cudaConvolutionFwdAlgo_t](#).

workSpace

Input. Data pointer to GPU memory to a workspace needed to be able to execute the specified algorithm. If no workspace is needed for a particular algorithm, that pointer can be nil.

workSpaceSizeInBytes

Input. Specifies the size in bytes of the provided `workSpace`.

zDesc

Input. Handle to a previously initialized tensor descriptor.

z

Input. Data pointer to GPU memory associated with the tensor descriptor `zDesc`.

biasDesc

Input. Handle to a previously initialized tensor descriptor.

bias

Input. Data pointer to GPU memory associated with the tensor descriptor `biasDesc`.

activationDesc

Input. Handle to a previously initialized activation descriptor. For more information, see [cudnnActivationDescriptor_t](#).

yDesc

Input. Handle to a previously initialized tensor descriptor.

y

Input/Output. Data pointer to GPU memory associated with the tensor descriptor `yDesc` that carries the result of the convolution.

For the convolution step, this function supports the specific combinations of data types for `xDesc`, `wDesc`, `convDesc`, and `yDesc` as listed in the documentation of [cudnnConvolutionForward\(\)](#). The following table specifies the supported combinations of data types for `x`, `y`, `z`, `bias`, and `alpha1/alpha2`.

Table 17. Supported combinations of data types (X = CUDNN_DATA)

x	w	convDesc	y and z	bias	alpha1/ alpha2
X_DOUBLE	X_DOUBLE	X_DOUBLE	X_DOUBLE	X_DOUBLE	X_DOUBLE
X_FLOAT	X_FLOAT	X_FLOAT	X_FLOAT	X_FLOAT	X_FLOAT
X_HALF	X_HALF	X_FLOAT	X_HALF	X_HALF	X_FLOAT
X_BFLOAT16	X_BFLOAT16	X_FLOAT	X_BFLOAT16	X_BFLOAT16	X_FLOAT
X_INT8	X_INT8	X_INT32	X_INT8	X_FLOAT	X_FLOAT
X_INT8	X_INT8	X_INT32	X_FLOAT	X_FLOAT	X_FLOAT
X_INT8x4	X_INT8x4	X_INT32	X_INT8x4	X_FLOAT	X_FLOAT
X_INT8x4	X_INT8x4	X_INT32	X_FLOAT	X_FLOAT	X_FLOAT

x	w	convDesc	y and z	bias	alpha1/ alpha2
X_UINT8	X_INT8	X_INT32	X_INT8	X_FLOAT	X_FLOAT
X_UINT8	X_INT8	X_INT32	X_FLOAT	X_FLOAT	X_FLOAT
X_UINT8x4	X_INT8x4	X_INT32	X_INT8x4	X_FLOAT	X_FLOAT
X_UINT8x4	X_INT8x4	X_INT32	X_FLOAT	X_FLOAT	X_FLOAT
X_INT8x32	X_INT8x32	X_INT32	X_INT8x32	X_FLOAT	X_FLOAT

Returns

In addition to the error values listed by the documentation of `cudaConvolutionForward()`, the possible error values returned by this function and their meanings are listed below.

CUDNN_STATUS_SUCCESS

The operation was launched successfully.

CUDNN_STATUS_BAD_PARAM

At least one of the following conditions are met:

- ▶ At least one of the following is NULL: `handle`, `xDesc`, `wDesc`, `convDesc`, `yDesc`, `zDesc`, `biasDesc`, `activationDesc`, `xData`, `wData`, `yData`, `zData`, `bias`, `alpha1`, `alpha2`.
- ▶ The number of dimensions of `xDesc`, `wDesc`, `yDesc`, `zDesc` is not equal to the array length of `convDesc` + 2.

CUDNN_STATUS_NOT_SUPPORTED

The function does not support the provided configuration. Some examples of non-supported configurations are as follows:

- ▶ The mode of `activationDesc` is neither `CUDNN_ACTIVATION_RELU` or `CUDNN_ACTIVATION_IDENTITY`.
- ▶ The `reluNanOpt` of `activationDesc` is not `CUDNN_NOT_PROPAGATE_NAN`.
- ▶ The second stride of `biasDesc` is not equal to one.
- ▶ The first dimension of `biasDesc` is not equal to one.
- ▶ The second dimension of `biasDesc` and the first dimension of `filterDesc` are not equal.
- ▶ The data type of `biasDesc` does not correspond to the data type of `yDesc` as listed in the above data types table.
- ▶ `zDesc` and `destDesc` do not match.

CUDNN_STATUS_EXECUTION_FAILED

The function failed to launch on the GPU.

5.2.10. `cudaConvolutionForward()`

```
cudaStatus_t cudaConvolutionForward(
```

```

    cudnnHandle_t          handle,
    const void            *alpha,
    const cudnnTensorDescriptor_t xDesc,
    const void            *x,
    const cudnnFilterDescriptor_t wDesc,
    const void            *w,
    const cudnnConvolutionDescriptor_t convDesc,
    cudnnConvolutionFwdAlgo_t algo,
    void                  *workSpace,
    size_t                workSpaceSizeInBytes,
    const void            *beta,
    const cudnnTensorDescriptor_t yDesc,
    void                  *y)

```

This function executes convolutions or cross-correlations over *x* using filters specified with *w*, returning results in *y*. Scaling factors *alpha* and *beta* can be used to scale the input tensor and the output tensor respectively.

Note: The routine [cudnnGetConvolution2dForwardOutputDim\(\)](#) or [cudnnGetConvolutionNdForwardOutputDim\(\)](#) can be used to determine the proper dimensions of the output tensor descriptor *yDesc* with respect to *xDesc*, *convDesc*, and *wDesc*.

Parameters

handle

Input. Handle to a previously created cuDNN context. For more information, see [cudnnHandle_t](#).

alpha, beta

Input. Pointers to scaling factors (in host memory) used to blend the computation result with prior value in the output layer as follows:

```
dstValue = alpha[0]*result + beta[0]*priorDstValue
```

For more information, see [Scaling Parameters](#) in the *cuDNN Developer Guide*.

xDesc

Input. Handle to a previously initialized tensor descriptor. For more information, see [cudnnTensorDescriptor_t](#).

x

Input. Data pointer to GPU memory associated with the tensor descriptor *xDesc*.

wDesc

Input. Handle to a previously initialized filter descriptor. For more information, see [cudnnFilterDescriptor_t](#).

w

Input. Data pointer to GPU memory associated with the filter descriptor *wDesc*.

convDesc

Input. Previously initialized convolution descriptor. For more information, see [cudnnConvolutionDescriptor_t](#).

algo

Input. Enumerant that specifies which convolution algorithm should be used to compute the results. For more information, see [cudaConvolutionFwdAlgo_t](#).

workSpace

Input. Data pointer to GPU memory to a workspace needed to be able to execute the specified algorithm. If no workspace is needed for a particular algorithm, that pointer can be nil.

workSpaceSizeInBytes

Input. Specifies the size in bytes of the provided `workSpace`.

yDesc

Input. Handle to a previously initialized tensor descriptor.

y

Input/Output. Data pointer to GPU memory associated with the tensor descriptor `yDesc` that carries the result of the convolution.

Supported configurations

This function supports the following combinations of data types for `xDesc`, `wDesc`, `convDesc`, and `yDesc`.

Table 18. Supported configurations

Data Type Configurations	xDesc and wDesc	convDesc	yDesc
TRUE_HALF_CONFIG (only supported on architectures with true FP16 support, meaning, compute capability 5.3 and later)	CUDNN_DATA_HALF	CUDNN_DATA_HALF	CUDNN_DATA_HALF
PSEUDO_HALF_CONFIG	CUDNN_DATA_HALF	CUDNN_DATA_FLOAT	CUDNN_DATA_HALF
PSEUDO_BFLOAT16_CONFIG (only support on architecture with bfloat16 support, meaning, compute capability 8.0 and later)	CUDNN_DATA_BFLOAT16	CUDNN_DATA_FLOAT	CUDNN_DATA_BFLOAT16

Data Type Configurations	xDesc and wDesc	convDesc	yDesc
FLOAT_CONFIG	CUDNN_DATA_FLOAT	CUDNN_DATA_FLOAT	CUDNN_DATA_FLOAT
DOUBLE_CONFIG	CUDNN_DATA_DOUBLE	CUDNN_DATA_DOUBLE	CUDNN_DATA_DOUBLE
INT8_CONFIG (only supported on architectures with DP4A support, meaning, compute capability 6.1 and later)	CUDNN_DATA_INT8	CUDNN_DATA_INT32	CUDNN_DATA_INT8
INT8_EXT_CONFIG (only supported on architectures with DP4A support, meaning, compute capability 6.1 and later)	CUDNN_DATA_INT8	CUDNN_DATA_INT32	CUDNN_DATA_FLOAT
INT8x4_CONFIG (only supported on architectures with DP4A support, meaning, compute capability 6.1 and later)	CUDNN_DATA_INT8x4	CUDNN_DATA_INT32	CUDNN_DATA_INT8x4
INT8x4_EXT_CONFIG (only supported on architectures with DP4A support, meaning, compute capability 6.1 and later)	CUDNN_DATA_INT8x4	CUDNN_DATA_INT32	CUDNN_DATA_FLOAT
UINT8_CONFIG (only supported on architectures with DP4A support, meaning, compute capability 6.1 and later)	xDesc: CUDNN_DATA_UINT8 wDesc: CUDNN_DATA_INT8	CUDNN_DATA_INT32	CUDNN_DATA_INT8
UINT8x4_CONFIG (only supported	xDesc: CUDNN_DATA_UINT8x4	CUDNN_DATA_INT32	CUDNN_DATA_INT8x4

Data Type Configurations	xDesc and wDesc	convDesc	yDesc
on architectures with DP4A support, meaning, compute capability 6.1 and later)	wDesc: CUDNN_DATA_INT8x4		
UINT8_EXT_CONFIG (only supported on architectures with DP4A support, meaning, compute capability 6.1 and later)	xDesc: CUDNN_DATA_UINT8 wDesc: CUDNN_DATA_INT8	CUDNN_DATA_INT32	CUDNN_DATA_FLOAT
UINT8x4_EXT_CONFIG (only supported on architectures with DP4A support, meaning, compute capability 6.1 and later)	xDesc: CUDNN_DATA_UINT8x4 wDesc: CUDNN_DATA_INT8x4	CUDNN_DATA_INT32	CUDNN_DATA_FLOAT
INT8x32_CONFIG (only supported on architectures with IMMA support, meaning compute capability 7.5 and later)	CUDNN_DATA_INT8x32	CUDNN_DATA_INT32	CUDNN_DATA_INT8x32

Supported algorithms

Note: For this function, all algorithms perform deterministic computations. Specifying a separate algorithm can cause changes in performance and support.

The table below shows the list of the supported 2D and 3D convolutions. The 2D convolutions are described first, followed by the 3D convolutions.

For the following terms, the short-form versions shown in the parenthesis are used in the table below, for brevity:

- ▶ CUDNN_CONVOLUTION_FWD_ALGO_IMPLICIT_GEMM (**_IMPLICIT_GEMM**)
- ▶ CUDNN_CONVOLUTION_FWD_ALGO_IMPLICIT_PRECOMP_GEMM (**_IMPLICIT_PRECOMP_GEMM**)
- ▶ CUDNN_CONVOLUTION_FWD_ALGO_GEMM (**_GEMM**)

- ▶ CUDNN_CONVOLUTION_FWD_ALGO_DIRECT (**_DIRECT**)
- ▶ CUDNN_CONVOLUTION_FWD_ALGO_FFT (**_FFT**)
- ▶ CUDNN_CONVOLUTION_FWD_ALGO_FFT_TILING (**_FFT_TILING**)
- ▶ CUDNN_CONVOLUTION_FWD_ALGO_WINOGRAD (**_WINOGRAD**)
- ▶ CUDNN_CONVOLUTION_FWD_ALGO_WINOGRAD_NONFUSED (**_WINOGRAD_NONFUSED**)
- ▶ CUDNN_TENSOR_NCHW (**_NCHW**)
- ▶ CUDNN_TENSOR_NHWC (**_NHWC**)
- ▶ CUDNN_TENSOR_NCHW_VECT_C (**_NCHW_VECT_C**)

Table 19. For 2D convolutions: wDesc: `_NCHW`

Filter descriptor wDesc: <code>_NCHW</code> (see cudnnTensorFormat_t)				
convDesc Group count support: Greater than 0, for all algos.				
Algo Name	Tensor Formats Supported for xDesc	Tensor Formats Supported for yDesc	Data Type Configurations Supported	Important
<code>_IMPLICIT_GEMM</code>	All except <code>_NCHW_VECT_C</code> .	All except <code>_NCHW_VECT_C</code> .	<code>TRUE_HALF_CONFIG</code> <code>PSEUDO_HALF_CONFIG</code> <code>PSEUDO_BFLOAT16_CONFIG</code> <code>FLOAT_CONFIG</code> <code>DOUBLE_CONFIG</code>	Dilation: Greater than 0 for all dimensions
<code>_IMPLICIT_PRECOMPUTED</code>	All except <code>_NCHW_VECT_C</code> .	All except <code>_NCHW_VECT_C</code> .	<code>TRUE_HALF_CONFIG</code> <code>PSEUDO_HALF_CONFIG</code> <code>PSEUDO_BFLOAT16_CONFIG</code> <code>FLOAT_CONFIG</code> <code>DOUBLE_CONFIG</code>	Dilation: 1 for all dimensions
<code>_GEMM</code>	All except <code>_NCHW_VECT_C</code> .	All except <code>_NCHW_VECT_C</code> .	<code>PSEUDO_HALF_CONFIG</code> <code>FLOAT_CONFIG</code> <code>DOUBLE_CONFIG</code>	Dilation: 1 for all dimensions
<code>_FFT</code>	NCHW HW-packed	NCHW HW-packed	<code>PSEUDO_HALF_CONFIG</code> <code>FLOAT_CONFIG</code>	Dilation: 1 for all dimensions xDesc feature map height + 2 * convDesc zero-padding height

Filter descriptor wDesc: _NCHW (see cudnnTensorFormat_t)				
convDesc Group count support: Greater than 0, for all algos.				
Algo Name	Tensor Formats Supported for xDesc	Tensor Formats Supported for yDesc	Data Type Configurations Supported	Important
				<p>must equal 256 or less</p> <p>xDesc feature map width + 2 * convDesc zero-padding width must equal 256 or less</p> <p>convDesc vertical and horizontal filter stride must equal 1</p> <p>wDesc filter height must be greater than convDesc zero-padding height</p> <p>wDesc filter width must be greater than convDesc zero-padding width</p>
_FFT_TILING			<p>PSEUDO_HALF_CONFIG</p> <p>FLOAT_CONFIG</p> <p>DOUBLE_CONFIG is also supported when the task can be handled by 1D FFT, meaning, one of the filter dimensions, width or height is 1.</p>	<p>Dilation: 1 for all dimensions</p> <p>When neither of wDesc filter dimension is 1, the filter width and height must not be larger than 32</p> <p>When either of wDesc filter dimension is 1, the largest filter</p>

Filter descriptor wDesc: <code>_NCHW</code> (see cudnnTensorFormat_t)				
convDesc Group count support: Greater than 0, for all algos.				
Algo Name	Tensor Formats Supported for <code>xDesc</code>	Tensor Formats Supported for <code>yDesc</code>	Data Type Configurations Supported	Important
				dimension should not exceed 256 convDesc vertical and horizontal filter stride must equal 1 when either the filter width or filter height is 1, otherwise the stride can be a 1 or 2 wDesc filter height must be greater than convDesc zero-padding height wDesc filter width must be greater than convDesc zero-padding width
<code>_WINOGRAD</code>	All except <code>_NCHW_VECT</code>	All except <code>_NCHW_VECT</code>	<code>PSEUDO_HALF_CONFIG</code> <code>C_FLOAT_CONFIG</code>	Dilation: 1 for all dimensions convDesc vertical and horizontal filter stride must equal 1 wDesc filter height must be 3 wDesc filter width must be 3
<code>_WINOGRAD_NONFUSED</code>			<code>TRUE_HALF_CONFIG</code> <code>PSEUDO_HALF_CONFIG</code>	Dilation: 1 for all dimensions

Filter descriptor wDesc: <code>_NCHW</code> (see cudnnTensorFormat_t)				
convDesc Group count support: Greater than 0, for all algos.				
Algo Name	Tensor Formats Supported for <code>xDesc</code>	Tensor Formats Supported for <code>yDesc</code>	Data Type Configurations Supported	Important
			PSEUDO_BFLOAT16_CONFIG FLOAT_CONFIG	<p><code>convDesc</code> vertical and horizontal filter stride must equal 1</p> <p><code>wDesc</code> filter (height, width) must be (3,3) or (5,5)</p> <p>If <code>wDesc</code> filter (height, width) is (5,5), then data type config <code>TRUE_HALF_CONFIG</code> is not supported.</p>
<code>_DIRECT</code>	Currently not implemented in cuDNN.			

Table 20. For 2D convolutions: `wDesc`: `_NCHWC`

Filter descriptor wDesc: <code>_NCHWC</code>				
convDesc Group count support: Greater than 0.				
Algo Name	<code>xDesc</code>	<code>yDesc</code>	Data Type Configurations Supported	Important
<code>_IMPLICIT_GEMM</code> <code>_IMPLICIT_PRECOMP_GEMM</code>	<code>_NCHW_VECT_C</code>	<code>_NCHW_VECT_C</code>	<code>INT8x4_CONFIG</code> <code>UINT8x4_CONFIG</code> <code>INT8x4_EXT_CONFIG</code> <code>UINT8x4_EXT_CONFIG</code>	Dilation: 1 for all dimensions
<code>_IMPLICIT_PRECOMP_GEMM</code>	<code>_NCHW_VECT_C</code>	<code>_NCHW_VECT_C</code>	<code>INT8x32_CONFIG</code>	<p>Dilation: 1 for all dimensions</p> <p>Requires compute capability 7.2 or above.</p>

Table 21. For 2D convolutions: wDesc: _NHWC

Filter descriptor wDesc: _NHWC				
convDesc Group count support: Greater than 0.				
Algo Name	xDesc	yDesc	Data Type Configurations Supported	Important
_IMPLICIT_GEMM _IMPLICIT_PRECOMP_GEMM	NHWC fully-packed	NHWC fully-packed	INT8_CONFIG INT8_EXT_CONFIG UINT8_CONFIG UINT8_EXT_CONFIG	Dilation: 1 for all dimensions Input and output feature maps must be a multiple of 4. Output features maps can be non-multiple in the case of INT8_EXT_CONFIG or UINT8_EXT_CONFIG.
_IMPLICIT_GEMM _IMPLICIT_PRECOMP_GEMM	NHWC HWC-packed.	NHWC HWC-packed. NCHW CHW-packed	TRUE_HALF_CONFIG PSEUDO_HALF_CONFIG PSEUDO_BFLOAT16_CONFIG FLOAT_CONFIG DOUBLE_CONFIG	

Table 22. For 3D convolutions: wDesc: _NCHW

Filter descriptor wDesc: _NCHW				
convDesc Group count support: Greater than 0, for all algos.				
Algo Name	xDesc	yDesc	Data Type Configurations Supported	Important
_IMPLICIT_GEMM	All except _NCHW_VECT_C.	All except _NCHW_VECT_C.	PSEUDO_HALF_CONFIG	Dilation: Greater than 0 for all dimensions
_IMPLICIT_PRECOMP_GEMM			PSEUDO_BFLOAT16_CONFIG FLOAT_CONFIG DOUBLE_CONFIG	

Filter descriptor wDesc: _NCHW				
convDesc Group count support: Greater than 0, for all algos.				
Algo Name	xDesc	yDesc	Data Type Configurations Supported	Important
_FFT_TILING	NCDHW DHW-packed	NCDHW DHW-packed		<p>Dilation: 1 for all dimensions</p> <p>wDesc filter height must equal 16 or less</p> <p>wDesc filter width must equal 16 or less</p> <p>wDesc filter depth must equal 16 or less</p> <p>convDesc must have all filter strides equal to 1</p> <p>wDesc filter height must be greater than convDesc zero-padding height</p> <p>wDesc filter width must be greater than convDesc zero-padding width</p> <p>wDesc filter depth must be greater than convDesc zero-padding width</p>

Table 23. For 3D convolutions: wDesc: _NHWC

Filter descriptor wDesc: _NHWC				
convDesc Group count support: Greater than 0, for all algos.				
Algo Name	xDesc	yDesc	Data Type Configurations Supported	Important
_IMPLICIT_PRECOMP_NDHW	NHWC DHWC-packed	NDHWC DHWC-packed	PSEUDO_HALF_CONFIG PSEUDO_BFLOAT16_CONFIG FLOAT_CONFIG	Dilation: Greater than 0 for all dimensions

Note: Tensors can be converted to and from CUDNN_TENSOR_NCHW_VECT_C with [cudnnTransformTensor\(\)](#).

Returns

CUDNN_STATUS_SUCCESS

The operation was launched successfully.

CUDNN_STATUS_BAD_PARAM

At least one of the following conditions are met:

- ▶ At least one of the following is NULL: handle, xDesc, wDesc, convDesc, yDesc, xData, w, yData, alpha, beta
- ▶ xDesc and yDesc have a non-matching number of dimensions
- ▶ xDesc and wDesc have a non-matching number of dimensions
- ▶ xDesc has fewer than three number of dimensions
- ▶ xDesc's number of dimensions is not equal to convDesc array length + 2
- ▶ xDesc and wDesc have a non-matching number of input feature maps per image (or group in case of grouped convolutions)
- ▶ yDesc or wDesc indicate an output channel count that isn't a multiple of group count (if group count has been set in convDesc).
- ▶ xDesc, wDesc, and yDesc have a non-matching data type
- ▶ For some spatial dimension, wDesc has a spatial size that is larger than the input spatial size (including zero-padding size)

CUDNN_STATUS_NOT_SUPPORTED

At least one of the following conditions are met:

- ▶ xDesc or yDesc have negative tensor striding
- ▶ xDesc, wDesc, or yDesc has a number of dimensions that is not 4 or 5

- ▶ yDesc spatial sizes do not match with the expected size as determined by [cudnnGetConvolutionNdForwardOutputDim\(\)](#)
- ▶ The chosen algo does not support the parameters provided; see above for an exhaustive list of parameters supported for each algo

CUDNN_STATUS_MAPPING_ERROR

An error occurs during the texture object creation associated with the filter data.

CUDNN_STATUS_EXECUTION_FAILED

The function failed to launch on the GPU.

5.2.11. **cudnnCreateConvolutionDescriptor()**

```

cudnnStatus_t cudnnCreateConvolutionDescriptor(
    cudnnConvolutionDescriptor_t *convDesc)
    
```

This function creates a convolution descriptor object by allocating the memory needed to hold its opaque structure. For more information, see [cudnnConvolutionDescriptor_t](#).

Returns

CUDNN_STATUS_SUCCESS

The object was created successfully.

CUDNN_STATUS_ALLOC_FAILED

The resources could not be allocated.

5.2.12. **cudnnDestroyConvolutionDescriptor()**

```

cudnnStatus_t cudnnDestroyConvolutionDescriptor(
    cudnnConvolutionDescriptor_t convDesc)
    
```

This function destroys a previously created convolution descriptor object.

Returns

CUDNN_STATUS_SUCCESS

The descriptor was destroyed successfully.

5.2.13. **cudnnFindConvolutionBackwardDataAlgorithm()**

```

cudnnStatus_t cudnnFindConvolutionBackwardDataAlgorithm(
    cudnnHandle_t             handle,
    const cudnnFilterDescriptor_t wDesc,
    const cudnnTensorDescriptor_t dyDesc,
    const cudnnConvolutionDescriptor_t convDesc,
    const cudnnTensorDescriptor_t dxDesc,
    const int requestedAlgoCount,
    int *returnedAlgoCount,
    cudnnConvolutionBwdDataAlgoPerf_t *perfResults)
    
```

This function attempts all algorithms available for [cudnnConvolutionBackwardData\(\)](#). It will attempt both the provided `convDesc` `mathType` and `CUDNN_DEFAULT_MATH` (assuming the two differ).



Note: Algorithms without the `CUDNN_TENSOR_OP_MATH` availability will only be tried with `CUDNN_DEFAULT_MATH`, and returned as such.

Memory is allocated via `cudaMalloc()`. The performance metrics are returned in the user-allocated array of [cudnnConvolutionBwdDataAlgoPerf_t](#). These metrics are written in a sorted fashion where the first element has the lowest compute time. The total number of resulting algorithms can be queried through the API [cudnnGetConvolutionBackwardDataAlgorithmMaxCount\(\)](#).



Note:

- ▶ This function is host blocking.
- ▶ It is recommended to run this function prior to allocating layer data; doing otherwise may needlessly inhibit some algorithm options due to resource usage.

Parameters

handle

Input. Handle to a previously created cuDNN context.

wDesc

Input. Handle to a previously initialized filter descriptor.

dyDesc

Input. Handle to the previously initialized input differential tensor descriptor.

convDesc

Input. Previously initialized convolution descriptor.

dxDesc

Input. Handle to the previously initialized output tensor descriptor.

requestedAlgoCount

Input. The maximum number of elements to be stored in `perfResults`.

returnedAlgoCount

Output. The number of output elements stored in `perfResults`.

perfResults

Output. A user-allocated array to store performance metrics sorted ascending by compute time.

Returns

CUDNN_STATUS_SUCCESS

The query was successful.

CUDNN_STATUS_BAD_PARAM

At least one of the following conditions are met:

- ▶ `handle` is not allocated properly.
- ▶ `wDesc`, `dyDesc`, or `dxDesc` is not allocated properly.
- ▶ `wDesc`, `dyDesc`, or `dxDesc` has fewer than 1 dimension.
- ▶ Either `returnedCount` or `perfResults` is nil.
- ▶ `requestedCount` is less than 1.

CUDNN_STATUS_ALLOC_FAILED

This function was unable to allocate memory to store sample input, filters and output.

CUDNN_STATUS_INTERNAL_ERROR

At least one of the following conditions are met:

- ▶ The function was unable to allocate necessary timing objects.
- ▶ The function was unable to deallocate necessary timing objects.
- ▶ The function was unable to deallocate sample input, filters and output.

5.2.14. cudnnFindConvolutionBackwardDataAlgorithmEx (

```

cudnnStatus_t cudnnFindConvolutionBackwardDataAlgorithmEx(
    cudnnHandle_t          handle,
    const cudnnFilterDescriptor_t wDesc,
    const void             *w,
    const cudnnTensorDescriptor_t dyDesc,
    const void             *dy,
    const cudnnConvolutionDescriptor_t convDesc,
    const cudnnTensorDescriptor_t dxDesc,
    void                  *dx,
    const int              requestedAlgoCount,
    int                   *returnedAlgoCount,
    cudnnConvolutionBwdDataAlgoPerf_t *perfResults,
    void                  *workSpace,
    size_t                workspaceSizeInBytes)
    
```

This function attempts all algorithms available for `cudnnConvolutionBackwardData()`. It will attempt both the provided `convDesc mathType` and `CUDNN_DEFAULT_MATH` (assuming the two differ).

Note: Algorithms without the `CUDNN_TENSOR_OP_MATH` availability will only be tried with `CUDNN_DEFAULT_MATH`, and returned as such.

Memory is allocated via `cudaMalloc()`. The performance metrics are returned in the user-allocated array of `cudnnConvolutionBwdDataAlgoPerf_t`. These metrics

are written in a sorted fashion where the first element has the lowest compute time. The total number of resulting algorithms can be queried through the API [cudnnGetConvolutionBackwardDataAlgorithmMaxCount\(\)](#).



Note: This function is host blocking.

Parameters

handle

Input. Handle to a previously created cuDNN context.

wDesc

Input. Handle to a previously initialized filter descriptor.

w

Input. Data pointer to GPU memory associated with the filter descriptor `wDesc`.

dyDesc

Input. Handle to the previously initialized input differential tensor descriptor.

dy

Input. Data pointer to GPU memory associated with the filter descriptor `dyDesc`.

convDesc

Input. Previously initialized convolution descriptor.

dxDesc

Input. Handle to the previously initialized output tensor descriptor.

dxDesc

Input/Output. Data pointer to GPU memory associated with the tensor descriptor `dxDesc`. The content of this tensor will be overwritten with arbitrary values.

requestedAlgoCount

Input. The maximum number of elements to be stored in `perfResults`.

returnedAlgoCount

Output. The number of output elements stored in `perfResults`.

perfResults

Output. A user-allocated array to store performance metrics sorted ascending by compute time.

workSpace

Input. Data pointer to GPU memory is a necessary workspace for some algorithms. The size of this workspace will determine the availability of algorithms. A nil pointer is considered a `workSpace` of 0 bytes.

workspaceSizeInBytes

Input. Specifies the size in bytes of the provided workspace.

Returns

CUDNN_STATUS_SUCCESS

The query was successful.

CUDNN_STATUS_BAD_PARAM

At least one of the following conditions are met:

- ▶ handle is not allocated properly.
- ▶ wDesc, dyDesc, or dxDesc is not allocated properly.
- ▶ wDesc, dyDesc, or dxDesc has fewer than 1 dimension.
- ▶ w, dy, or dx is nil.
- ▶ Either returnedCount or perfResults is nil.
- ▶ requestedCount is less than 1.

CUDNN_STATUS_INTERNAL_ERROR

At least one of the following conditions are met:

- ▶ The function was unable to allocate necessary timing objects.
- ▶ The function was unable to deallocate necessary timing objects.
- ▶ The function was unable to deallocate sample input, filters and output.

5.2.15. cudnnFindConvolutionForwardAlgorithm()

```

cudnnStatus_t cudnnFindConvolutionForwardAlgorithm(
    cudnnHandle_t          handle,
    const cudnnTensorDescriptor_t  xDesc,
    const cudnnFilterDescriptor_t   wDesc,
    const cudnnConvolutionDescriptor_t convDesc,
    const cudnnTensorDescriptor_t  yDesc,
    const int               requestedAlgoCount,
    int                     *returnedAlgoCount,
    cudnnConvolutionFwdAlgoPerf_t  *perfResults)
    
```

This function attempts all algorithms available for [cudnnConvolutionForward\(\)](#). It will attempt both the provided convDesc mathType and CUDNN_DEFAULT_MATH (assuming the two differ).

Note: Algorithms without the CUDNN_TENSOR_OP_MATH availability will only be tried with CUDNN_DEFAULT_MATH, and returned as such.

Memory is allocated via cudaMalloc(). The performance metrics are returned in the user-allocated array of cudnnConvolutionFwdAlgoPerf_t. These metrics are written in a sorted fashion where the first element has the lowest compute

time. The total number of resulting algorithms can be queried through the API [cuda_{nn}GetConvolutionForwardAlgorithmMaxCount\(\)](#).



Note:

- ▶ This function is host blocking.
- ▶ It is recommended to run this function prior to allocating layer data; doing otherwise may needlessly inhibit some algorithm options due to resource usage.

Parameters

handle

Input. Handle to a previously created cuDNN context.

xDesc

Input. Handle to the previously initialized input tensor descriptor.

wDesc

Input. Handle to a previously initialized filter descriptor.

convDesc

Input. Previously initialized convolution descriptor.

yDesc

Input. Handle to the previously initialized output tensor descriptor.

requestedAlgoCount

Input. The maximum number of elements to be stored in `perfResults`.

returnedAlgoCount

Output. The number of output elements stored in `perfResults`.

perfResults

Output. A user-allocated array to store performance metrics sorted ascending by compute time.

Returns

CUDNN_STATUS_SUCCESS

The query was successful.

CUDNN_STATUS_BAD_PARAM

At least one of the following conditions are met:

- ▶ `handle` is not allocated properly.
- ▶ `xDesc`, `wDesc`, or `yDesc` are not allocated properly.
- ▶ `xDesc`, `wDesc`, or `yDesc` has fewer than 1 dimension.

- ▶ Either returnedCount or perfResults is nil.
- ▶ requestedCount is less than 1.

CUDNN_STATUS_ALLOC_FAILED

This function was unable to allocate memory to store sample input, filters and output.

CUDNN_STATUS_INTERNAL_ERROR

At least one of the following conditions are met:

- ▶ The function was unable to allocate necessary timing objects.
- ▶ The function was unable to deallocate necessary timing objects.
- ▶ The function was unable to deallocate sample input, filters and output.

5.2.16. cudnnFindConvolutionForwardAlgorithmEx()

```

cudnnStatus_t cudnnFindConvolutionForwardAlgorithmEx(
    cudnnHandle_t          handle,
    const cudnnTensorDescriptor_t  xDesc,
    const void             *x,
    const cudnnFilterDescriptor_t  wDesc,
    const void             *w,
    const cudnnConvolutionDescriptor_t  convDesc,
    const cudnnTensorDescriptor_t  yDesc,
    void                   *y,
    const int              requestedAlgoCount,
    int                     *returnedAlgoCount,
    cudnnConvolutionFwdAlgoPerf_t  *perfResults,
    void                   *workSpace,
    size_t                  workSpaceSizeInBytes)
    
```

This function attempts all algorithms available for [cudnnConvolutionForward\(\)](#). It will attempt both the provided convDesc mathType and CUDNN_DEFAULT_MATH (assuming the two differ).

Note: Algorithms without the CUDNN_TENSOR_OP_MATH availability will only be tried with CUDNN_DEFAULT_MATH, and returned as such.

Memory is allocated via `cudaMalloc()`. The performance metrics are returned in the user-allocated array of `cudnnConvolutionFwdAlgoPerf_t`. These metrics are written in a sorted fashion where the first element has the lowest compute time. The total number of resulting algorithms can be queried through the API [cudnnGetConvolutionForwardAlgorithmMaxCount\(\)](#).

Note: This function is host blocking.

Parameters

handle

Input. Handle to a previously created cuDNN context.

xDesc

Input. Handle to the previously initialized input tensor descriptor.

x

Input. Data pointer to GPU memory associated with the tensor descriptor `xDesc`.

wDesc

Input. Handle to a previously initialized filter descriptor.

w

Input. Data pointer to GPU memory associated with the filter descriptor `wDesc`.

convDesc

Input. Previously initialized convolution descriptor.

yDesc

Input. Handle to the previously initialized output tensor descriptor.

y

Input/Output. Data pointer to GPU memory associated with the tensor descriptor `yDesc`. The content of this tensor will be overwritten with arbitrary values.

requestedAlgoCount

Input. The maximum number of elements to be stored in `perfResults`.

returnedAlgoCount

Output. The number of output elements stored in `perfResults`.

perfResults

Output. A user-allocated array to store performance metrics sorted ascending by compute time.

workSpace

Input. Data pointer to GPU memory is a necessary workspace for some algorithms. The size of this workspace will determine the availability of algorithms. A nil pointer is considered a `workSpace` of 0 bytes.

workSpaceSizeInBytes

Input. Specifies the size in bytes of the provided `workSpace`.

Returns**CUDNN_STATUS_SUCCESS**

The query was successful.

CUDNN_STATUS_BAD_PARAM

At least one of the following conditions are met:

- ▶ `handle` is not allocated properly.
- ▶ `xDesc`, `wDesc`, or `yDesc` are not allocated properly.
- ▶ `xDesc`, `wDesc`, or `yDesc` has fewer than 1 dimension.

- ▶ x, w, or y is nil.
- ▶ Either returnedCount or perfResults is nil.
- ▶ requestedCount is less than 1.

CUDNN_STATUS_INTERNAL_ERROR

At least one of the following conditions are met:

- ▶ The function was unable to allocate necessary timing objects.
- ▶ The function was unable to deallocate necessary timing objects.
- ▶ The function was unable to deallocate sample input, filters and output.

5.2.17. cudnnGetConvolution2dDescriptor()

```

cudnnStatus_t cudnnGetConvolution2dDescriptor(
    const cudnnConvolutionDescriptor_t convDesc,
    int *pad_h,
    int *pad_w,
    int *u,
    int *v,
    int *dilation_h,
    int *dilation_w,
    cudnnConvolutionMode_t *mode,
    cudnnDataType_t *computeType)
    
```

This function queries a previously initialized 2D convolution descriptor object.

Parameters

convDesc

Input/Output. Handle to a previously created convolution descriptor.

pad_h

Output. Zero-padding height: number of rows of zeros implicitly concatenated onto the top and onto the bottom of input images.

pad_w

Output. Zero-padding width: number of columns of zeros implicitly concatenated onto the left and onto the right of input images.

u

Output. Vertical filter stride.

v

Output. Horizontal filter stride.

dilation_h

Output. Filter height dilation.

dilation_w

Output. Filter width dilation.

mode

Output. Convolution mode.

computeType

Output. Compute precision.

Returns

CUDNN_STATUS_SUCCESS

The operation was successful.

CUDNN_STATUS_BAD_PARAM

The parameter `convDesc` is nil.

5.2.18. **cudaGetConvolution2dForwardOutputDim()**

```

cudaStatus_t cudaGetConvolution2dForwardOutputDim(
    const cudaConvolutionDescriptor_t convDesc,
    const cudaTensorDescriptor_t inputTensorDesc,
    const cudaFilterDescriptor_t filterDesc,
    int *n,
    int *c,
    int *h,
    int *w)

```

This function returns the dimensions of the resulting 4D tensor of a 2D convolution, given the convolution descriptor, the input tensor descriptor and the filter descriptor. This function can help to setup the output tensor and allocate the proper amount of memory prior to launch the actual convolution.

Each dimension `h` and `w` of the output images is computed as follows:

```

outputDim = 1 + ( inputDim + 2*pad - (((filterDim-1)*dilation)+1) ) /
convolutionStride;

```

 **Note:** The dimensions provided by this routine must be strictly respected when calling [cudaConvolutionForward\(\)](#) or [cudaConvolutionBackwardBias\(\)](#). Providing a smaller or larger output tensor is not supported by the convolution routines.

Parameters

convDesc

Input. Handle to a previously created convolution descriptor.

inputTensorDesc

Input. Handle to a previously initialized tensor descriptor.

filterDesc

Input. Handle to a previously initialized filter descriptor.

n

Output. Number of output images.

c

Output. Number of output feature maps per image.

h

Output. Height of each output feature map.

w

Output. Width of each output feature map.

Returns

CUDNN_STATUS_BAD_PARAM

One or more of the descriptors has not been created correctly or there is a mismatch between the feature maps of `inputTensorDesc` and `filterDesc`.

CUDNN_STATUS_SUCCESS

The object was set successfully.

5.2.19. `cudaGetConvolutionBackwardDataAlgorithmMaxCount`

```
cudaStatus_t cudaGetConvolutionBackwardDataAlgorithmMaxCount (
    cudaHandle_t      handle,
    int               *count)
```

This function returns the maximum number of algorithms which can be returned from `cudaFindConvolutionBackwardDataAlgorithm()` and `cudaGetConvolutionForwardAlgorithm_v7()`. This is the sum of all algorithms plus the sum of all algorithms with Tensor Core operations supported for the current device.

Parameters

handle

Input. Handle to a previously created cuDNN context.

count

Output. The resulting maximum number of algorithms.

Returns

CUDNN_STATUS_SUCCESS

The function was successful.

CUDNN_STATUS_BAD_PARAM

The provided handle is not allocated properly.

5.2.20. cudnnGetConvolutionBackwardDataAlgorithm_v7 (

```

cudnnStatus_t cudnnGetConvolutionBackwardDataAlgorithm_v7(
    cudnnHandle_t          handle,
    const cudnnFilterDescriptor_t    wDesc,
    const cudnnTensorDescriptor_t    dyDesc,
    const cudnnConvolutionDescriptor_t convDesc,
    const cudnnTensorDescriptor_t    dxDesc,
    const int              requestedAlgoCount,
    int                    *returnedAlgoCount,
    cudnnConvolutionBwdDataAlgoPerf_t *perfResults)
    
```

This function serves as a heuristic for obtaining the best suited algorithm for [cudnnConvolutionBackwardData\(\)](#) for the given layer specifications. This function will return all algorithms (including CUDNN_TENSOR_OP_MATH and CUDNN_DEFAULT_MATH versions of algorithms where CUDNN_TENSOR_OP_MATH may be available) sorted by expected (based on internal heuristic) relative performance with the fastest being index 0 of perfResults. For an exhaustive search for the fastest algorithm, use [cudnnFindConvolutionBackwardDataAlgorithm\(\)](#). The total number of resulting algorithms can be queried through the returnedAlgoCount variable.

Parameters

handle

Input. Handle to a previously created cuDNN context.

wDesc

Input. Handle to a previously initialized filter descriptor.

dyDesc

Input. Handle to the previously initialized input differential tensor descriptor.

convDesc

Input. Previously initialized convolution descriptor.

dxDesc

Input. Handle to the previously initialized output tensor descriptor.

requestedAlgoCount

Input. The maximum number of elements to be stored in perfResults.

returnedAlgoCount

Output. The number of output elements stored in perfResults.

perfResults

Output. A user-allocated array to store performance metrics sorted ascending by compute time.

Returns

CUDNN_STATUS_SUCCESS

The query was successful.

CUDNN_STATUS_BAD_PARAM

At least one of the following conditions are met:

- ▶ One of the parameters `handle`, `wDesc`, `dyDesc`, `convDesc`, `dxDesc`, `perfResults`, `returnedAlgoCount` is NULL.
- ▶ The numbers of feature maps of the input tensor and output tensor differ.
- ▶ The `dataType` of the two tensor descriptors or the filters are different.
- ▶ `requestedAlgoCount` is less than or equal to 0.

5.2.21. cudnnGetConvolutionBackwardDataWorkspaceSize

```

cudnnStatus_t cudnnGetConvolutionBackwardDataWorkspaceSize(
    cudnnHandle_t          handle,
    const cudnnFilterDescriptor_t    wDesc,
    const cudnnTensorDescriptor_t    dyDesc,
    const cudnnConvolutionDescriptor_t convDesc,
    const cudnnTensorDescriptor_t    dxDesc,
    cudnnConvolutionBwdDataAlgo_t    algo,
    size_t                 *sizeInBytes)
    
```

This function returns the amount of GPU memory workspace the user needs to allocate to be able to call [cudnnConvolutionBackwardData\(\)](#) with the specified algorithm. The workspace allocated will then be passed to the routine [cudnnConvolutionBackwardData\(\)](#). The specified algorithm can be the result of the call to [cudnnGetConvolutionBackwardDataAlgorithm_v7\(\)](#) or can be chosen arbitrarily by the user. Note that not every algorithm is available for every configuration of the input tensor and/or every configuration of the convolution descriptor.

Parameters

handle

Input. Handle to a previously created cuDNN context.

wDesc

Input. Handle to a previously initialized filter descriptor.

dyDesc

Input. Handle to the previously initialized input differential tensor descriptor.

convDesc

Input. Previously initialized convolution descriptor.

dxDesc

Input. Handle to the previously initialized output tensor descriptor.

algo

Input. Enumerant that specifies the chosen convolution algorithm.

sizeInBytes

Output. Amount of GPU memory needed as workspace to be able to execute a forward convolution with the specified `algo`.

Returns

CUDNN_STATUS_SUCCESS

The query was successful.

CUDNN_STATUS_BAD_PARAM

At least one of the following conditions are met:

- ▶ The numbers of feature maps of the input tensor and output tensor differ.
- ▶ The `dataType` of the two tensor descriptors or the filter are different.

CUDNN_STATUS_NOT_SUPPORTED

The combination of the tensor descriptors, filter descriptor and convolution descriptor is not supported for the specified algorithm.

5.2.22. `cudaGetConvolutionForwardAlgorithmMaxCount`

```

cudaStatus_t cudaGetConvolutionForwardAlgorithmMaxCount(
    cudaHandle_t handle,
    int *count)
    
```

This function returns the maximum number of algorithms which can be returned from `cudaFindConvolutionForwardAlgorithm()` and `cudaGetConvolutionForwardAlgorithm_v7()`. This is the sum of all algorithms plus the sum of all algorithms with Tensor Core operations supported for the current device.

Parameters

handle

Input. Handle to a previously created cuDNN context.

count

Output. The resulting maximum number of algorithms.

Returns

CUDNN_STATUS_SUCCESS

The function was successful.

CUDNN_STATUS_BAD_PARAM

The provided handle is not allocated properly.

5.2.23. cudnnGetConvolutionForwardAlgorithm_v7()

```

cudnnStatus_t cudnnGetConvolutionForwardAlgorithm_v7(
    cudnnHandle_t          handle,
    const cudnnTensorDescriptor_t  xDesc,
    const cudnnFilterDescriptor_t  wDesc,
    const cudnnConvolutionDescriptor_t  convDesc,
    const cudnnTensorDescriptor_t  yDesc,
    const int              requestedAlgoCount,
    int                   *returnedAlgoCount,
    cudnnConvolutionFwdAlgoPerf_t  *perfResults)
    
```

This function serves as a heuristic for obtaining the best suited algorithm for [cudnnConvolutionForward\(\)](#) for the given layer specifications. This function will return all algorithms (including CUDNN_TENSOR_OP_MATH and CUDNN_DEFAULT_MATH versions of algorithms where CUDNN_TENSOR_OP_MATH may be available) sorted by expected (based on internal heuristic) relative performance with the fastest being index 0 of perfResults. For an exhaustive search for the fastest algorithm, use [cudnnFindConvolutionForwardAlgorithm\(\)](#). The total number of resulting algorithms can be queried through the returnedAlgoCount variable.

Parameters

handle

Input. Handle to a previously created cuDNN context.

xDesc

Input. Handle to the previously initialized input tensor descriptor.

wDesc

Input. Handle to a previously initialized convolution filter descriptor.

convDesc

Input. Previously initialized convolution descriptor.

yDesc

Input. Handle to the previously initialized output tensor descriptor.

requestedAlgoCount

Input. The maximum number of elements to be stored in perfResults.

returnedAlgoCount

Output. The number of output elements stored in perfResults.

perfResults

Output. A user-allocated array to store performance metrics sorted ascending by compute time.

Returns

CUDNN_STATUS_SUCCESS

The query was successful.

CUDNN_STATUS_BAD_PARAM

At least one of the following conditions are met:

- ▶ One of the parameters `handle`, `xDesc`, `wDesc`, `convDesc`, `yDesc`, `perfResults`, `returnedAlgoCount` is NULL.
- ▶ Either `yDesc` or `wDesc` have different dimensions from `xDesc`.
- ▶ The data types of tensors `xDesc`, `yDesc` or `wDesc` are not all the same.
- ▶ The number of feature maps in `xDesc` and `wDesc` differs.
- ▶ The tensor `xDesc` has a dimension smaller than 3.
- ▶ `requestedAlgoCount` is less than or equal to 0.

5.2.24. cudnnGetConvolutionForwardWorkspaceSize()

```

cudnnStatus_t cudnnGetConvolutionForwardWorkspaceSize(
    cudnnHandle_t handle,
    const cudnnTensorDescriptor_t xDesc,
    const cudnnFilterDescriptor_t wDesc,
    const cudnnConvolutionDescriptor_t convDesc,
    const cudnnTensorDescriptor_t yDesc,
    cudnnConvolutionFwdAlgo_t algo,
    size_t *sizeInBytes)
    
```

This function returns the amount of GPU memory workspace the user needs to allocate to be able to call `cudnnConvolutionForward()` with the specified algorithm. The workspace allocated will then be passed to the routine `cudnnConvolutionForward()`. The specified algorithm can be the result of the call to `cudnnGetConvolutionForwardAlgorithm_v7()` or can be chosen arbitrarily by the user. Note that not every algorithm is available for every configuration of the input tensor and/or every configuration of the convolution descriptor.

Parameters

handle

Input. Handle to a previously created cuDNN context.

xDesc

Input. Handle to the previously initialized x tensor descriptor.

wDesc

Input. Handle to a previously initialized filter descriptor.

convDesc

Input. Previously initialized convolution descriptor.

yDesc

Input. Handle to the previously initialized `y` tensor descriptor.

algo

Input. Enumerant that specifies the chosen convolution algorithm.

sizeInBytes

Output. Amount of GPU memory needed as workspace to be able to execute a forward convolution with the specified `algo`.

Returns

CUDNN_STATUS_SUCCESS

The query was successful.

CUDNN_STATUS_BAD_PARAM

At least one of the following conditions are met:

- ▶ One of the parameters `handle`, `xDesc`, `wDesc`, `convDesc`, `yDesc` is NULL.
- ▶ The tensor `yDesc` or `wDesc` are not of the same dimension as `xDesc`.
- ▶ The tensor `xDesc`, `yDesc` or `wDesc` are not of the same data type.
- ▶ The numbers of feature maps of the tensor `xDesc` and `wDesc` differ.
- ▶ The tensor `xDesc` has a dimension smaller than 3.

CUDNN_STATUS_NOT_SUPPORTED

The combination of the tensor descriptors, filter descriptor and convolution descriptor is not supported for the specified algorithm.

5.2.25. cudnnGetConvolutionGroupCount()

```

cudnnStatus_t cudnnGetConvolutionGroupCount(
    cudnnConvolutionDescriptor_t convDesc,
    int *groupCount)
    
```

This function returns the group count specified in the given convolution descriptor.

Returns

CUDNN_STATUS_SUCCESS

The group count was returned successfully.

CUDNN_STATUS_BAD_PARAM

An invalid convolution descriptor was provided.

5.2.26. cudnnGetConvolutionMathType()

```

cudnnStatus_t cudnnGetConvolutionMathType(
    cudnnConvolutionDescriptor_t convDesc,
    )
    
```

```

    cudnnMathType_t          *mathType)

```

This function returns the math type specified in a given convolution descriptor.

Returns

CUDNN_STATUS_SUCCESS

The math type was returned successfully.

CUDNN_STATUS_BAD_PARAM

An invalid convolution descriptor was provided.

5.2.27. cudnnGetConvolutionNdDescriptor()

```

cudnnStatus_t cudnnGetConvolutionNdDescriptor(
    const cudnnConvolutionDescriptor_t convDesc,
    int          arrayLengthRequested,
    int          *arrayLength,
    int          padA[],
    int          filterStrideA[],
    int          dilationA[],
    cudnnConvolutionMode_t *mode,
    cudnnDataType_t *dataType)

```

This function queries a previously initialized convolution descriptor object.

Parameters

convDesc

Input/Output. Handle to a previously created convolution descriptor.

arrayLengthRequested

Input. Dimension of the expected convolution descriptor. It is also the minimum size of the arrays `padA`, `filterStrideA`, and `dilationA` in order to be able to hold the results

arrayLength

Output. Actual dimension of the convolution descriptor.

padA

Output. Array of dimension of at least `arrayLengthRequested` that will be filled with the padding parameters from the provided convolution descriptor.

filterStrideA

Output. Array of dimension of at least `arrayLengthRequested` that will be filled with the filter stride from the provided convolution descriptor.

dilationA

Output. Array of dimension of at least `arrayLengthRequested` that will be filled with the dilation parameters from the provided convolution descriptor.

mode

Output. Convolution mode of the provided descriptor.

datatype

Output. Datatype of the provided descriptor.

Returns

CUDNN_STATUS_SUCCESS

The query was successful.

CUDNN_STATUS_BAD_PARAM

At least one of the following conditions are met:

- ▶ The descriptor `convDesc` is nil.
- ▶ The `arrayLengthRequest` is negative.

CUDNN_STATUS_NOT_SUPPORTED

The `arrayLengthRequested` is greater than `CUDNN_DIM_MAX-2`.

5.2.28. `cudaGetConvolutionNdForwardOutputDim()`

```

cudaStatus_t cudaGetConvolutionNdForwardOutputDim(
    const cudaConvolutionDescriptor_t convDesc,
    const cudaTensorDescriptor_t inputTensorDesc,
    const cudaFilterDescriptor_t filterDesc,
    int nbDims,
    int tensorOutputDimA[])
    
```

This function returns the dimensions of the resulting n-D tensor of a `nbDims-2`-D convolution, given the convolution descriptor, the input tensor descriptor and the filter descriptor. This function can help to setup the output tensor and allocate the proper amount of memory prior to launch the actual convolution.

Each dimension of the `(nbDims-2)`-D images of the output tensor is computed as follows:

```

outputDim = 1 + ( inputDim + 2*pad - (((filterDim-1)*dilation)+1) ) /
convolutionStride;
    
```

 **Note:** The dimensions provided by this routine must be strictly respected when calling [cudaConvolutionForward\(\)](#) or [cudaConvolutionBackwardBias\(\)](#). Providing a smaller or larger output tensor is not supported by the convolution routines.

Parameters

convDesc

Input. Handle to a previously created convolution descriptor.

inputTensorDesc

Input. Handle to a previously initialized tensor descriptor.

filterDesc

Input. Handle to a previously initialized filter descriptor.

nbDims

Input. Dimension of the output tensor.

tensorOutputDimA

Output. Array of dimensions `nbDims` that contains on exit of this routine the sizes of the output tensor.

Returns

CUDNN_STATUS_BAD_PARAM

At least one of the following conditions are met:

- ▶ One of the parameters `convDesc`, `inputTensorDesc`, and `filterDesc` is nil.
- ▶ The dimension of the filter descriptor `filterDesc` is different from the dimension of input tensor descriptor `inputTensorDesc`.
- ▶ The dimension of the convolution descriptor is different from the dimension of input tensor descriptor `inputTensorDesc-2`.
- ▶ The features map of the filter descriptor `filterDesc` is different from the one of input tensor descriptor `inputTensorDesc`.
- ▶ The size of the dilated filter `filterDesc` is larger than the padded sizes of the input tensor.
- ▶ The dimension `nbDims` of the output array is negative or greater than the dimension of input tensor descriptor `inputTensorDesc`.

CUDNN_STATUS_SUCCESS

The routine exited successfully.

5.2.29. **cudnnGetConvolutionReorderType()**

```
cudnnStatus_t cudnnGetConvolutionReorderType (
    cudnnConvolutionDescriptor_t convDesc,
    cudnnReorderType_t *reorderType);
```

This function retrieves the convolution reorder type from the given convolution descriptor.

Parameters

convDesc

Input. The convolution descriptor from which the reorder type should be retrieved.

reorderType

Output. The retrieved reorder type. For more information, see [cudnnReorderType_t](#).

Returns

CUDNN_STATUS_BAD_PARAM

One of the inputs to this function is not valid.

CUDNN_STATUS_SUCCESS

The reorder type is retrieved successfully.

5.2.30. cudnnGetFoldedConvBackwardDataDescriptors ()

```

cudnnStatus_t
cudnnGetFoldedConvBackwardDataDescriptors(const cudnnHandle_t handle,
                                          const cudnnFilterDescriptor_t filterDesc,
                                          const cudnnTensorDescriptor_t diffDesc,
                                          const cudnnConvolutionDescriptor_t
convDesc,
                                          const cudnnTensorDescriptor_t gradDesc,
                                          const cudnnTensorFormat_t transformFormat,
                                          const cudnnFilterDescriptor_t foldedFilterDesc,
                                          const cudnnTensorDescriptor_t paddedDiffDesc,
                                          const cudnnConvolutionDescriptor_t
foldedConvDesc,
                                          cudnnTensorDescriptor_t foldedGradDesc,
                                          cudnnTensorTransformDescriptor_t
filterFoldTransDesc,
                                          cudnnTensorTransformDescriptor_t
diffPadTransDesc,
                                          cudnnTensorTransformDescriptor_t
gradFoldTransDesc,
                                          cudnnTensorTransformDescriptor_t
gradUnfoldTransDesc) ;

```

This function calculates folding descriptors for backward data gradient. It takes as input the data descriptors along with convolution descriptor and computes the folded data descriptors and the folding transform descriptors. These can then be used to do the actual folding transform.

Parameters

handle

Input. Handle to a previously created cuDNN context.

filterDesc

Input. Filter descriptor before folding.

diffDesc

Input. Diff descriptor before folding.

convDesc

Input. Convolution descriptor before folding.

gradDesc

Input. Gradient descriptor before folding.

transformFormat

Input. Transform format for folding.

foldedFilterDesc

Output. Folded filter descriptor.

paddedDiffDesc

Output. Padded Diff descriptor.

foldedConvDesc

Output. Folded convolution descriptor.

foldedGradDesc

Output. Folded gradient descriptor.

filterFoldTransDesc

Output. Folding transform descriptor for filter.

diffPadTransDesc

Output. Folding transform descriptor for Desc.

gradFoldTransDesc

Output. Folding transform descriptor for gradient.

gradUnfoldTransDesc

Output. Unfolding transform descriptor for folded gradient.

Returns

CUDNN_STATUS_SUCCESS

Folded descriptors were computed successfully.

CUDNN_STATUS_BAD_PARAM

If any of the input parameters is NULL or if the input tensor has more than 4 dimensions.

CUDNN_STATUS_EXECUTION_FAILED

Computing the folded descriptors failed.

5.2.31. cudnnIm2Col()

```

cudnnStatus_t cudnnIm2Col(
    cudnnHandle_t          handle,
    cudnnTensorDescriptor_t srcDesc,
    const void            *srcData,
    cudnnFilterDescriptor_t filterDesc,
    cudnnConvolutionDescriptor_t convDesc,
    void                  *colBuffer)
    
```

This function constructs the A matrix necessary to perform a forward pass of GEMM convolution. This A matrix has a height of `batch_size*y_height*y_width` and width of `input_channels*filter_height*filter_width`, where:

- ▶ batch_size is xDesc first dimension
- ▶ y_height/y_width are computed from cudnnGetConvolutionNdForwardOutputDim()
- ▶ input_channels is xDesc second dimension
- ▶ filter_height/filter_width are wDesc third and fourth dimension

The A matrix is stored in format HW fully-packed in GPU memory.

Parameters

handle

Input. Handle to a previously created cuDNN context.

srcDesc

Input. Handle to a previously initialized tensor descriptor.

srcData

Input. Data pointer to GPU memory associated with the input tensor descriptor.

filterDesc

Input. Handle to a previously initialized filter descriptor.

convDesc

Input. Handle to a previously initialized convolution descriptor.

colBuffer

Output. Data pointer to GPU memory storing the output matrix.

Returns

CUDNN_STATUS_BAD_PARAM

srcData or colBuffer is NULL.

CUDNN_STATUS_NOT_SUPPORTED

Any of srcDesc, filterDesc, convDesc has dataType of CUDNN_DATA_INT8, CUDNN_DATA_INT8x4, CUDNN_DATA_INT8 or CUDNN_DATA_INT8x4 convDesc has groupCount larger than 1.

CUDNN_STATUS_EXECUTION_FAILED

The CUDA kernel execution was unsuccessful.

CUDNN_STATUS_SUCCESS

The output data array is successfully generated.

5.2.32. cudnnReorderFilterAndBias()

```

cudnnStatus_t cudnnReorderFilterAndBias(
    cudnnHandle_t handle,
    const cudnnFilterDescriptor_t filterDesc,

```



```

    cudnnReorderType_t reorderType,
    const void *filterData,
    void *reorderedFilterData,
    int reorderBias,
    const void *biasData,
    void *reorderedBiasData);

```

This function [cudnnReorderFilterAndBias\(\)](#), reorders the filter and bias values for tensor with data type CUDNN_DATA_INT8x32. It can be used to enhance the inference time by separating the reordering operation from convolution.

Filter and bias tensor with data type CUDNN_DATA_INT8x32 requires permutation of output channel axes in order to take advantage of the Tensor Core IMMA instruction. This is done in every [cudnnConvolutionForward\(\)](#) and [cudnnConvolutionBiasActivationForward\(\)](#) call when the reorder type attribute of the convolution descriptor is set to CUDNN_DEFAULT_REORDER. Users can avoid the repeated reordering kernel call by first using this call to reorder the filter and bias tensor and call the convolution forward APIs with reorder type set to CUDNN_NO_REORDER.

For example, convolutions in a neural network of multiple layers can require reordering of kernels at every layer, which can take up a significant fraction of the total inference time. Using this function, the reordering can be done one time on the filter and bias data followed by the convolution operations at the multiple layers, thereby enhancing the inference time.

Parameters

handle

Input. Handle to a previously created cuDNN context.

filterDesc

Input. Descriptor for the kernel dataset.

reorderType

Input. Setting to either perform reordering or not. For more information, see [cudnnReorderType_t](#).

filterData

Input. Pointer to the filter (kernel) data location in the device memory.

reorderedFilterData

Output. Pointer to the location in the device memory where the reordered filter data will be written to, by this function.

reorderBias

Input. If > 0, then reorders the bias data also. If <= 0 then does not perform reordering operations on the bias data.

biasData

Input. Pointer to the bias data location in the device memory.

reorderedBiasData

Output. Pointer to the location in the device memory where the reordered bias data will be written to, by this function.

Returns

CUDNN_STATUS_SUCCESS

Reordering was successful.

CUDNN_STATUS_EXECUTION_FAILED

Either the reordering of the filter data or of the bias data failed.

5.2.33. cudnnSetConvolution2dDescriptor()

```

cudnnStatus_t cudnnSetConvolution2dDescriptor(
    cudnnConvolutionDescriptor_t convDesc,
    int pad_h,
    int pad_w,
    int u,
    int v,
    int dilation_h,
    int dilation_w,
    cudnnConvolutionMode_t mode,
    cudnnDataType_t computeType)
    
```

This function initializes a previously created convolution descriptor object into a 2D correlation. This function assumes that the tensor and filter descriptors correspond to the forward convolution path and checks if their settings are valid. That same convolution descriptor can be reused in the backward path provided it corresponds to the same layer.

Parameters

convDesc

Input/Output. Handle to a previously created convolution descriptor.

pad_h

Input. Zero-padding height: number of rows of zeros implicitly concatenated onto the top and onto the bottom of input images.

pad_w

Input. Zero-padding width: number of columns of zeros implicitly concatenated onto the left and onto the right of input images.

u

Input. Vertical filter stride.

v

Input. Horizontal filter stride.

dilation_h

Input. Filter height dilation.

dilation_w

Input. Filter width dilation.

mode

Input. Selects between CUDNN_CONVOLUTION and CUDNN_CROSS_CORRELATION.

computeType

Input. Compute precision.

Returns

CUDNN_STATUS_SUCCESS

The object was set successfully.

CUDNN_STATUS_BAD_PARAM

At least one of the following conditions are met:

- ▶ The descriptor `convDesc` is nil.
- ▶ One of the parameters `pad_h`, `pad_w` is strictly negative.
- ▶ One of the parameters `u`, `v` is negative or zero.
- ▶ One of the parameters `dilation_h`, `dilation_w` is negative or zero.
- ▶ The parameter `mode` has an invalid enumerant value.

5.2.34. `cudaSetConvolutionGroupCount()`

```
cudaStatus_t cudaSetConvolutionGroupCount(
    cudaConvolutionDescriptor_t convDesc,
    int groupCount)
```

This function allows the user to specify the number of groups to be used in the associated convolution.

Returns

CUDNN_STATUS_SUCCESS

The group count was set successfully.

CUDNN_STATUS_BAD_PARAM

An invalid convolution descriptor was provided

5.2.35. `cudaSetConvolutionMathType()`

```
cudaStatus_t cudaSetConvolutionMathType(
    cudaConvolutionDescriptor_t convDesc,
    cudaMathType_t mathType)
```

This function allows the user to specify whether or not the use of tensor op is permitted in the library routines associated with a given convolution descriptor.

Returns

CUDNN_STATUS_SUCCESS

The math type was set successfully.

CUDNN_STATUS_BAD_PARAM

Either an invalid convolution descriptor was provided or an invalid math type was specified.

5.2.36. cudnnSetConvolutionNdDescriptor()

```

cudnnStatus_t cudnnSetConvolutionNdDescriptor(
    cudnnConvolutionDescriptor_t convDesc,
    int arrayLength,
    const int padA[],
    const int filterStrideA[],
    const int dilationA[],
    cudnnConvolutionMode_t mode,
    cudnnDataType_t dataType)

```

This function initializes a previously created generic convolution descriptor object into a n-D correlation. That same convolution descriptor can be reused in the backward path provided it corresponds to the same layer. The convolution computation will be done in the specified dataType, which can be potentially different from the input/output tensors.

Parameters

convDesc

Input/Output. Handle to a previously created convolution descriptor.

arrayLength

Input. Dimension of the convolution.

padA

Input. Array of dimension arrayLength containing the zero-padding size for each dimension. For every dimension, the padding represents the number of extra zeros implicitly concatenated at the start and at the end of every element of that dimension.

filterStrideA

Input. Array of dimension arrayLength containing the filter stride for each dimension. For every dimension, the filter stride represents the number of elements to slide to reach the next start of the filtering window of the next point.

dilationA

Input. Array of dimension arrayLength containing the dilation factor for each dimension.

mode

Input. Selects between CUDNN_CONVOLUTION and CUDNN_CROSS_CORRELATION.

datatype

Input. Selects the data type in which the computation will be done.

 **Note:** CUDNN_DATA_HALF in [cudnnSetConvolutionNdDescriptor\(\)](#) with HALF_CONVOLUTION_BWD_FILTER is not recommended as it is known to not be useful for any practical use case for training and will be considered to be blocked in a future cuDNN release. The use of CUDNN_DATA_HALF for input tensors in [cudnnSetTensorNdDescriptor\(\)](#) and CUDNN_DATA_FLOAT in [cudnnSetConvolutionNdDescriptor\(\)](#) with HALF_CONVOLUTION_BWD_FILTER is

recommended and is used with the automatic mixed precision (AMP) training in many well known deep learning frameworks.

Returns

CUDNN_STATUS_SUCCESS

The object was set successfully.

CUDNN_STATUS_BAD_PARAM

At least one of the following conditions are met:

- ▶ The descriptor `convDesc` is nil.
- ▶ The `arrayLengthRequest` is negative.
- ▶ The enumerant `mode` has an invalid value.
- ▶ The enumerant `datatype` has an invalid value.
- ▶ One of the elements of `padA` is strictly negative.
- ▶ One of the elements of `strideA` is negative or zero.
- ▶ One of the elements of `dilationA` is negative or zero.

CUDNN_STATUS_NOT_SUPPORTED

At least one of the following conditions are met:

- ▶ The `arrayLengthRequest` is greater than `CUDNN_DIM_MAX`.

5.2.37. `cudnnSetConvolutionReorderType()`

```
cudnnStatus_t cudnnSetConvolutionReorderType(
    cudnnConvolutionDescriptor_t convDesc,
    cudnnReorderType_t reorderType);
```

This function sets the convolution reorder type for the given convolution descriptor.

Parameters

`convDesc`

Input. The convolution descriptor for which the reorder type should be set.

`reorderType`

Input. Set the reorder type to this value. For more information, see [cudnnReorderType_t](#).

Returns

CUDNN_STATUS_BAD_PARAM

The reorder type supplied is not supported.

CUDNN_STATUS_SUCCESS

Reorder type is set successfully.

Chapter 6. `cuda_cnn_train.so` Library

6.1. Data Type References

6.1.1. Pointer To Opaque Struct Types

6.1.1.1. `cudaFusedOpsConstParamPack_t`

`cudaFusedOpsConstParamPack_t` is a pointer to an opaque structure holding the description of the `cudaFusedOps` constant parameters. Use the function [`cudaCreateFusedOpsConstParamPack\(\)`](#) to create one instance of this structure, and the function [`cudaDestroyFusedOpsConstParamPack\(\)`](#) to destroy a previously-created descriptor.

6.1.1.2. `cudaFusedOpsPlan_t`

`cudaFusedOpsPlan_t` is a pointer to an opaque structure holding the description of the `cudaFusedOpsPlan`. This descriptor contains the plan information, including the problem type and size, which kernels should be run, and the internal workspace partition. Use the function [`cudaCreateFusedOpsPlan\(\)`](#) to create one instance of this structure, and the function [`cudaDestroyFusedOpsPlan\(\)`](#) to destroy a previously-created descriptor.

6.1.1.3. `cudaFusedOpsVariantParamPack_t`

`cudaFusedOpsVariantParamPack_t` is a pointer to an opaque structure holding the description of the `cudaFusedOps` variant parameters. Use the function [`cudaCreateFusedOpsVariantParamPack\(\)`](#) to create one instance of this structure, and the function [`cudaDestroyFusedOpsVariantParamPack\(\)`](#) to destroy a previously-created descriptor.

6.1.2. Struct Types

6.1.2.1. `cudaConvolutionBwdFilterAlgoPerf_t`

`cudaConvolutionBwdFilterAlgoPerf_t` is a structure containing performance results returned by `cudaFindConvolutionBackwardFilterAlgorithm()` or heuristic results returned by `cudaGetConvolutionBackwardFilterAlgorithm_v7()`.

Data Members

`cudaConvolutionBwdFilterAlgo_t algo`

The algorithm runs to obtain the associated performance metrics.

`cudaStatus_t status`

If any error occurs during the workspace allocation or timing of `cudaConvolutionBackwardFilter()`, this status will represent that error. Otherwise, this status will be the return status of `cudaConvolutionBackwardFilter()`.

- ▶ `CUDNN_STATUS_ALLOC_FAILED` if any error occurred during workspace allocation or if the provided workspace is insufficient.
- ▶ `CUDNN_STATUS_INTERNAL_ERROR` if any error occurred during timing calculations or workspace deallocation.
- ▶ Otherwise, this will be the return status of `cudaConvolutionBackwardFilter()`.

`float time`

The execution time of `cudaConvolutionBackwardFilter()` (in milliseconds).

`size_t memory`

The workspace size (in bytes).

`cudaDeterminism_t determinism`

The determinism of the algorithm.

`cudaMathType_t mathType`

The math type provided to the algorithm.

`int reserved[3]`

Reserved space for future properties.

6.1.3. Enumeration Types

6.1.3.1. `cudaFusedOps_t`

The `cudaFusedOps_t` type is an enumerated type to select a specific sequence of computations to perform in the fused operations.

Member	Description
<code>CUDNN_FUSED_SCALE_BIAS_ACTIVATION_CONV_BNS</code> = 0	On a per-channel basis, performs these operations in this order: scale, add bias, activation, convolution, and generate batchnorm statistics.

Member	Description
CUDNN_FUSED_SCALE_BIAS_ACTIVATION_WGRAD = 1	On a per-channel basis, performs these operations in this order: scale, add bias, activation, convolution backward weights, and generate batchnorm statistics.
<p>CUDNN_FUSED_SCALE_BIAS_ACTIVATION_WGRAD</p>	
CUDNN_FUSED_BN_FINALIZE_STATISTICS_TRAINING = 2	Computes the equivalent scale and bias from $ySum$, $ySqSum$ and learned $scale$, $bias$. Optionally update running statistics and generate saved stats
CUDNN_FUSED_BN_FINALIZE_STATISTICS_INFERENCE = 3	Computes the equivalent scale and bias from the learned running statistics and the learned $scale$, $bias$.
CUDNN_FUSED_CONV_SCALE_BIAS_ADD_ACTIVATION = 4	On a per-channel basis, performs these operations in this order: convolution, scale, add bias, element-wise addition with another tensor, and activation.
CUDNN_FUSED_SCALE_BIAS_ADD_ACTIVATION_GENERIC = 5	On a per-channel basis, performs these operations in this order: scale and bias on one tensor, scale, and bias on a second tensor, element-wise addition of these two tensors, and on the resulting tensor perform activation, and generate activation bit mask.
CUDNN_FUSED_DACTIVATION_FORK_DBATCHNORM = 6	On a per-channel basis, performs these operations in this order: backward activation, fork (meaning, write out gradient for the residual branch), and backward batch norm.

6.1.3.2. cudnnFusedOpsConstParamLabel_t

The cudnnFusedOpsConstParamLabel_t is an enumerated type for the selection of the type of the cudnnFusedOps descriptor. For more information, see [cudnnSetFusedOpsConstParamPackAttribute\(\)](#).

```
typedef enum {
    CUDNN_PARAM_XDESC = 0,
    CUDNN_PARAM_XDATA_PLACEHOLDER = 1,
    CUDNN_PARAM_BN_MODE = 2,
    CUDNN_PARAM_BN_EQSCALEBIAS_DESC = 3,
    CUDNN_PARAM_BN_EQSCALE_PLACEHOLDER = 4,
    CUDNN_PARAM_BN_EQBIAS_PLACEHOLDER = 5,
    CUDNN_PARAM_ACTIVATION_DESC = 6,
    CUDNN_PARAM_CONV_DESC = 7,
    CUDNN_PARAM_WDESC = 8,
    CUDNN_PARAM_WDATA_PLACEHOLDER = 9,
    CUDNN_PARAM_DWDESC = 10,
    CUDNN_PARAM_DWDATA_PLACEHOLDER = 11,
    CUDNN_PARAM_YDESC = 12,
    CUDNN_PARAM_YDATA_PLACEHOLDER = 13,
    CUDNN_PARAM_DYDESC = 14,
    CUDNN_PARAM_DYDATA_PLACEHOLDER = 15,
    CUDNN_PARAM_YSTATS_DESC = 16,
    CUDNN_PARAM_YSUM_PLACEHOLDER = 17,
    CUDNN_PARAM_YSQSUM_PLACEHOLDER = 18,
    CUDNN_PARAM_BN_SCALEBIAS_MEANVAR_DESC = 19,
    CUDNN_PARAM_BN_SCALE_PLACEHOLDER = 20,
    CUDNN_PARAM_BN_BIAS_PLACEHOLDER = 21,
    CUDNN_PARAM_BN_SAVED_MEAN_PLACEHOLDER = 22,
    CUDNN_PARAM_BN_SAVED_INVSTD_PLACEHOLDER = 23,
    CUDNN_PARAM_BN_RUNNING_MEAN_PLACEHOLDER = 24,
    CUDNN_PARAM_BN_RUNNING_VAR_PLACEHOLDER = 25,
    CUDNN_PARAM_ZDESC = 26,
    CUDNN_PARAM_ZDATA_PLACEHOLDER = 27,
    CUDNN_PARAM_BN_Z_EQSCALEBIAS_DESC = 28,
    CUDNN_PARAM_BN_Z_EQSCALE_PLACEHOLDER = 29,
    CUDNN_PARAM_BN_Z_EQBIAS_PLACEHOLDER = 30,
    CUDNN_PARAM_ACTIVATION_BITMASK_DESC = 31,
    CUDNN_PARAM_ACTIVATION_BITMASK_PLACEHOLDER = 32,
    CUDNN_PARAM_DXDESC = 33,
    CUDNN_PARAM_DXDATA_PLACEHOLDER = 34,
    CUDNN_PARAM_DZDESC = 35,
    CUDNN_PARAM_DZDATA_PLACEHOLDER = 36,
    CUDNN_PARAM_BN_DSCALE_PLACEHOLDER = 37,
    CUDNN_PARAM_BN_DBIAS_PLACEHOLDER = 38,
} cudnnFusedOpsConstParamLabel_t;
```

Short-form used	Stands for
Setter	cudnnSetFusedOpsConstParamPackAttribute()
Getter	cudnnGetFusedOpsConstParamPackAttribute()
X_ pointerPlaceholder_t	cudnnFusedOpsPointerPlaceholder_t
x_ prefix in the Attribute column	Stands for CUDNN_PARAM_ in the enumerator name

Table 24. CUDNN_FUSED_SCALE_BIAS_ACTIVATION_CONV_BNSTATS

For the attribute CUDNN_FUSED_SCALE_BIAS_ACTIVATION_CONV_BNSTATS in cudnnFusedOp_t			
Attribute	Expected Descriptor Type Passed in, in the Setter	Description	Default Value After Creation
X_XDESC	In the setter, the *param should be xDesc, a pointer to a previously initialized cudnnTensorDescriptor_t.	Tensor descriptor describing the size, layout, and datatype of the x (input) tensor.	NULL
X_XDATA_PLACEHOLDER	In the setter, the *param should be a pointer to a previously initialized X_PointerPlaceholder_t.	Describes whether xData pointer in the VariantParamPack will be NULL, or if not, user promised pointer alignment *.	CUDNN_PTR_NULL
X_BN_MODE	In the setter, the *param should be a pointer to a previously initialized cudnnBatchNormMode_t.	Describes the mode of operation for the scale, bias and the statistics. *As of cuDNN 7.6.0, only CUDNN_BATCHNORM_SPATIAL and CUDNN_BATCHNORM_SPATIAL_PERSISTENT are supported, meaning, scale, bias, and statistics are all per-channel.	CUDNN_BATCHNORM_PER_ACTIVATION
X_BN_EQSCALEBIAS_DESCRIPTOR	In the setter, the *param should be a pointer to a previously initialized cudnnTensorDescriptor_t.	Tensor descriptor describing the size, layout, and datatype of the batchNorm equivalent scale and bias tensors. The shapes must match the mode specified in CUDNN_PARAM_BN_MODE. If set to NULL, both scale and bias operation will become a NOP.	NULL
X_BN_EQSCALE_PLACEHOLDER	In the setter, the *param should be a pointer to a previously initialized X_PointerPlaceholder_t.	Describes whether batchnorm equivalent scale pointer in the VariantParamPack will be NULL, or if not, user promised pointer alignment *.	CUDNN_PTR_NULL

For the attribute CUDNN_FUSED_SCALE_BIAS_ACTIVATION_CONV_BNSTATS in cudnnFusedOp_t			
Attribute	Expected Descriptor Type Passed in, in the Setter	Description	Default Value After Creation
		If set to CUDNN_PTR_NULL, then the scale operation becomes a NOP.	
X_BN_EQBIAS_PLACEHOLDER	In the setter, the *param should be a pointer to a previously initialized X_PointerPlaceholder_t.	Describes whether batchnorm equivalent bias pointer in the VariantParamPack will be NULL, or if not, user promised pointer alignment *. If set to CUDNN_PTR_NULL, then the bias operation becomes a NOP.	CUDNN_PTR_NULL
X_ACTIVATION_DESC	In the setter, the *param should be a pointer to a previously initialized cudnnActivationDescriptor_t.	Describes the activation operation. As of cuDNN 7.6.0, only activation modes of CUDNN_ACTIVATION_RELU and CUDNN_ACTIVATION_IDENTITY are supported. If set to NULL or if the activation mode is set to CUDNN_ACTIVATION_IDENTITY, then the activation in the op sequence becomes a NOP.	NULL
X_CONV_DESC	In the setter, the *param should be a pointer to a previously initialized cudnnConvolutionDescriptor_t.	Describes the convolution operation.	NULL
X_WDESC	In the setter, the *param should be a pointer to a previously initialized cudnnFilterDescriptor_t.	Filter descriptor describing the size, layout and datatype of the w (filter) tensor.	NULL
X_WDATA_PLACEHOLDER	In the setter, the *param should be a pointer to a previously initialized X_PointerPlaceholder_t.	Describes whether w (filter) tensor pointer in the VariantParamPack will be NULL, or if not, user promised pointer alignment *.	CUDNN_PTR_NULL

For the attribute CUDNN_FUSED_SCALE_BIAS_ACTIVATION_CONV_BNSTATS in cudnnFusedOp_t			
Attribute	Expected Descriptor Type Passed in, in the Setter	Description	Default Value After Creation
		user promised pointer alignment *.	
X_YDESC	In the setter, the *param should be a pointer to a previously initialized cudnnTensorDescriptor_t*.	Tensor descriptor describing the size, layout and datatype of the y (output) tensor.	NULL
X_YDATA_PLACEHOLDER	In the setter, the *param should be a pointer to a previously initialized X_PointerPlaceholder_t	Describes whether y (output) tensor pointer in the VariantParamPack will be NULL, or if not, user promised pointer alignment *.	CUDNN_PTR_NULL
X_YSTATS_DESC	In the setter, the *param should be a pointer to a previously initialized cudnnTensorDescriptor_t*	Tensor descriptor describing the size, layout and datatype of the sum of y and sum of y square tensors. The shapes need to match the mode specified in CUDNN_PARAM_BN_MODE. If set to NULL, the y statistics generation operation will become a NOP.	NULL
X_YSUM_PLACEHOLDER	In the setter, the *param should be a pointer to a previously initialized X_PointerPlaceholder_t	Describes whether sum of y pointer in the VariantParamPack will be NULL, or if not, user promised pointer alignment *. If set to CUDNN_PTR_NULL, the y statistics generation operation will become a NOP.	CUDNN_PTR_NULL
X_YSQSUM_PLACEHOLDER	In the setter, the *param should be a pointer to a previously initialized X_PointerPlaceholder_t	Describes whether sum of y square pointer in the VariantParamPack will be NULL, or if not, user promised pointer alignment *.	CUDNN_PTR_NULL

For the attribute `CUDNN_FUSED_SCALE_BIAS_ACTIVATION_CONV_BNSTATS` in `cudaFusedOp_t`

Attribute	Expected Descriptor Type Passed in, in the Setter	Description	Default Value After Creation
		If set to <code>CUDNN_PTR_NULL</code> , the statistics generation operation will become a NOP.	

Note:

- ▶ If the corresponding pointer placeholder in `ConstParamPack` is set to `CUDNN_PTR_NULL`, then the device pointer in the `VariantParamPack` needs to be `NULL` as well.
- ▶ If the corresponding pointer placeholder in `ConstParamPack` is set to `CUDNN_PTR_ELEM_ALIGNED` or `CUDNN_PTR_16B_ALIGNED`, then the device pointer in the `VariantParamPack` may not be `NULL` and need to be at least element-aligned or 16 bytes-aligned, respectively.

As of cuDNN 7.6.0, if the conditions in [Table 25](#) are met, then the fully fused fast path will be triggered. Otherwise, a slower partially fused path will be triggered.

Table 25. Conditions for Fully Fused Fast Path (Forward)

Parameter	Condition
Device compute capability	Need to be one of 7.0, 7.2 or 7.5.
<code>CUDNN_PARAM_XDESC</code> <code>CUDNN_PARAM_XDATA_PLACEHOLDER</code>	Tensor is 4 dimensional Datatype is <code>CUDNN_DATA_HALF</code> Layout is NHWC fully packed Alignment is <code>CUDNN_PTR_16B_ALIGNED</code> Tensor's c dimension is a multiple of 8.
<code>CUDNN_PARAM_BN_EQSCALEBIAS_DESC</code> <code>CUDNN_PARAM_BN_EQSCALE_PLACEHOLDER</code> <code>CUDNN_PARAM_BN_EQBIAS_PLACEHOLDER</code>	If either one of scale and bias operation is not turned into a NOP: Tensor is 4 dimensional with shape 1xCx1x1 Datatype is <code>CUDNN_DATA_HALF</code> Layout is fully packed Alignment is <code>CUDNN_PTR_16B_ALIGNED</code>
<code>CUDNN_PARAM_CONV_DESC</code> <code>CUDNN_PARAM_WDESC</code> <code>CUDNN_PARAM_WDATA_PLACEHOLDER</code>	Convolution descriptor's mode needs to be <code>CUDNN_CROSS_CORRELATION</code> . Convolution descriptor's <code>dataType</code> needs to be <code>CUDNN_DATA_FLOAT</code> . Convolution descriptor's <code>dilationA</code> is {1,1}.

Parameter	Condition
	<p>Convolution descriptor's group count needs to be 1.</p> <p>Convolution descriptor's mathType needs to be CUDNN_TENSOR_OP_MATH or CUDNN_TENSOR_OP_MATH_ALLOW_CONVERSION.</p> <p>Filter is in NHWC layout</p> <p>Filter's data type is CUDNN_DATA_HALF</p> <p>Filter's K dimension is a multiple of 32</p> <p>Filter size RxS is either 1x1 or 3x3</p> <p>If filter size RxS is 1x1, convolution descriptor's padA needs to be (0,0) and filterStrideA needs to be (1,1).</p> <p>Filter's alignment is CUDNN_PTR_16B_ALIGNED</p>
CUDNN_PARAM_YDESC CUDNN_PARAM_YDATA_PLACEHOLDER	<p>Tensor is 4 dimensional</p> <p>Datatype is CUDNN_DATA_HALF</p> <p>Layout is NHWC fully packed</p> <p>Alignment is CUDNN_PTR_16B_ALIGNED</p>
CUDNN_PARAM_YSTATS_DESC CUDNN_PARAM_YSUM_PLACEHOLDER CUDNN_PARAM_YSQSUM_PLACEHOLDER	<p>If the generate statistics operation is not turned into a NOP:</p> <p>Tensor is 4 dimensional with shape 1xKx1x1</p> <p>Datatype is CUDNN_DATA_FLOAT</p> <p>Layout is fully packed</p> <p>Alignment is CUDNN_PTR_16B_ALIGNED</p>

Table 26. CUDNN_FUSED_SCALE_BIAS_ACTIVATION_WGRAD

For the attribute CUDNN_FUSED_SCALE_BIAS_ACTIVATION_WGRAD in cudnnFusedOp_t			
Attribute	Expected Descriptor Type Passed in, in the Setter	Description	Default Value After Creation
X_XDESC	In the setter, the *param should be xDesc, a pointer to a previously initialized cudnnTensorDescriptor_t.	Tensor descriptor describing the size, layout and datatype of the x (input) tensor	NULL
X_XDATA_PLACEHOLDER	In the setter, the *param should be a pointer to a previously initialized X_PointerPlaceholder_t*.	Describes whether xData pointer in the VariantParamPack will be NULL, or if not,	CUDNN_PTR_NULL

For the attribute CUDNN_FUSED_SCALE_BIAS_ACTIVATION_WGRAD in cudnnFusedOp_t

Attribute	Expected Descriptor Type Passed in, in the Setter	Description	Default Value After Creation
		user promised pointer alignment *.	
X_BN_MODE	In the setter, the *param should be a pointer to a previously initialized cudnnBatchNormMode_t* .	Describes the mode of operation for the scale, bias and the statistics. As of cuDNN 7.6.0, only CUDNN_BATCHNORM_SPATIAL and CUDNN_BATCHNORM_SPATIAL_PERSISTENT are supported, meaning, scale, bias, and statistics are all per-channel.	CUDNN_BATCHNORM_PER_ACTIVATION
X_BN_EQSCALEBIAS_DESC	In the setter, the *param should be a pointer to a previously initialized cudnnTensorDescriptor_t* .	Tensor descriptor describing the size, layout and datatype of the batchNorm equivalent scale and bias tensors. The shapes must match the mode specified in CUDNN_PARAM_BN_MODE. If set to NULL, both scale and bias operation will become a NOP.	NULL
X_BN_EQSCALE_PLACEHOLDER	In the setter, the *param should be a pointer to a previously initialized X_PointerPlaceholder_t* .	Describes whether batchnorm equivalent scale pointer in the VariantParamPack will be NULL, or if not, user promised pointer alignment *. If set to CUDNN_PTR_NULL, then the scale operation becomes a NOP.	CUDNN_PTR_NULL
X_BN_EQBIAS_PLACEHOLDER	In the setter, the *param should be a pointer to a previously initialized X_PointerPlaceholder_t* .	Describes whether batchnorm equivalent bias pointer in the VariantParamPack will be NULL, or if not,	CUDNN_PTR_NULL

For the attribute CUDNN_FUSED_SCALE_BIAS_ACTIVATION_WGRAD in cudnnFusedOp_t			
Attribute	Expected Descriptor Type Passed in, in the Setter	Description	Default Value After Creation
		<p>user promised pointer alignment *.</p> <p>If set to CUDNN_PTR_NULL, then the bias operation becomes a NOP.</p>	
X_ACTIVATION_DESC	In the setter, the *param should be a pointer to a previously initialized cudnnActivationDescriptor_t* .	<p>Describes the activation operation.</p> <p>As of cuDNN 7.6.0, only activation mode of CUDNN_ACTIVATION_RELU and CUDNN_ACTIVATION_IDENTITY is supported. If set to NULL or if the activation mode is set to CUDNN_ACTIVATION_IDENTITY, then the activation in the op sequence becomes a NOP.</p>	NULL
X_CONV_DESC	In the setter, the *param should be a pointer to a previously initialized cudnnConvolutionDescriptor_t* .	Describes the convolution operation.	NULL
X_DWDESC	In the setter, the *param should be a pointer to a previously initialized cudnnFilterDescriptor_t* .	Filter descriptor describing the size, layout and datatype of the dw (filter gradient output) tensor.	NULL
X_DWDATA_PLACEHOLDER	In the setter, the *param should be a pointer to a previously initialized X_PointerPlaceHolder_t* .	Describes whether dw (filter gradient output) tensor pointer in the VariantParamPack will be NULL, or if not, user promised pointer alignment *.	CUDNN_PTR_NULL
X_DYDESC	In the setter, the *param should be a pointer to a previously initialized cudnnTensorDescriptor_t* .	Tensor descriptor describing the size, layout and datatype of the dy (gradient input) tensor.	NULL

For the attribute CUDNN_FUSED_SCALE_BIAS_ACTIVATION_WGRAD in cudnnFusedOp_t

Attribute	Expected Descriptor Type Passed in, in the Setter	Description	Default Value After Creation
X_DYDATA_PLACEHOLDER	In the setter, the *param should be a pointer to a previously initialized X_PointerPlaceHolder	Describes whether dy (gradient input) tensor pointer in the VariantParamPack will be NULL, or if not, user promised pointer alignment *.	CUDNN_PTR_NULL

Note:

- ▶ If the corresponding pointer placeholder in ConstParamPack is set to CUDNN_PTR_NULL, then the device pointer in the VariantParamPack needs to be NULL as well.
- ▶ If the corresponding pointer placeholder in ConstParamPack is set to CUDNN_PTR_ELEM_ALIGNED or CUDNN_PTR_16B_ALIGNED, then the device pointer in the VariantParamPack may not be NULL and needs to be at least element-aligned or 16 bytes-aligned, respectively.

As of cuDNN 7.6.0, if the conditions in [Table 27](#) are met, then the fully fused fast path will be triggered. Otherwise a slower partially fused path will be triggered.

Table 27. Conditions for Fully Fused Fast Path (Backward)

Parameter	Condition
Device compute capability	Needs to be one of 7.0, 7.2 or 7.5.
CUDNN_PARAM_XDESC CUDNN_PARAM_XDATA_PLACEHOLDER	Tensor is 4 dimensional Datatype is CUDNN_DATA_HALF Layout is NHWC fully packed Alignment is CUDNN_PTR_16B_ALIGNED Tensor's c dimension is a multiple of 8.
CUDNN_PARAM_BN_EQSCALEBIAS_DESC CUDNN_PARAM_BN_EQSCALE_PLACEHOLDER CUDNN_PARAM_BN_EQBIAS_PLACEHOLDER	If either one of scale and bias operation is not turned into a NOP: Tensor is 4 dimensional with shape 1xCx1x1 Datatype is CUDNN_DATA_HALF Layout is fully packed Alignment is CUDNN_PTR_16B_ALIGNED
CUDNN_PARAM_CONV_DESC CUDNN_PARAM_DWDESC CUDNN_PARAM_DWDATA_PLACEHOLDER	Convolution descriptor's mode needs to be CUDNN_CROSS_CORRELATION. Convolution descriptor's dataType needs to be CUDNN_DATA_FLOAT.

Parameter	Condition
	<p>Convolution descriptor's dilationA is {1,1}</p> <p>Convolution descriptor's group count needs to be 1.</p> <p>Convolution descriptor's mathType needs to be CUDNN_TENSOR_OP_MATH or CUDNN_TENSOR_OP_MATH_ALLOW_CONVERSION.</p> <p>Filter gradient is in NHWC layout</p> <p>Filter gradient's data type is CUDNN_DATA_HALF</p> <p>Filter gradient's k dimension is a multiple of 32.</p> <p>Filter gradient size RxS is either 1x1 or 3x3</p> <p>If filter gradient size RxS is 1x1, convolution descriptor's padA needs to be {0,0} and filterStrideA needs to be {1,1}.</p> <p>Filter gradient's alignment is CUDNN_PTR_16B_ALIGNED</p>
CUDNN_PARAM_DYDESC CUDNN_PARAM_DYDATA_PLACEHOLDER	<p>Tensor is 4 dimensional</p> <p>Datatype is CUDNN_DATA_HALF</p> <p>Layout is NHWC fully packed</p> <p>Alignment is CUDNN_PTR_16B_ALIGNED</p>

Table 28. CUDNN_FUSED_BN_FINALIZE_STATISTICS_TRAINING

For the attribute CUDNN_FUSED_BN_FINALIZE_STATISTICS_TRAINING in cudnnFusedOp_t			
Attribute	Expected Descriptor Type Passed in, in the Setter	Description	Default Value After Creation
X_BN_MODE	In the setter, the *param should be a pointer to a previously initialized cudnnBatchNormMode_t* .	Describes the mode of operation for the scale, bias and the statistics. As of cuDNN 7.6.0, only CUDNN_BATCHNORM_SPATIAL and CUDNN_BATCHNORM_SPATIAL_PERSISTENT are supported, meaning, scale, bias and statistics are all per-channel.	CUDNN_BATCHNORM_PER_ACTIVATION
X_YSTATS_DESC	In the setter, the *param should	Tensor descriptor describing the size,	NULL

For the attribute CUDNN_FUSED_BN_FINALIZE_STATISTICS_TRAINING in cudnnFusedOp_t

Attribute	Expected Descriptor Type Passed in, in the Setter	Description	Default Value After Creation
	be a pointer to a previously initialized <code>cudnnTensorDescriptor</code>	layout and datatype of the sum of y and sum of y square tensors. The shapes need to match the mode specified in CUDNN_PARAM_BN_MODE.	
X_YSUM_PLACEHOLDER	In the setter, the <code>*param</code> should be a pointer to a previously initialized <code>X_PointerPlaceholder</code>	Describes whether sum of y pointer in the <code>VariantParamPack</code> will be NULL, or if not, user promised pointer alignment <code>*</code> .	CUDNN_PTR_NULL
X_YSQSUM_PLACEHOLDER	In the setter, the <code>*param</code> should be a pointer to a previously initialized <code>X_PointerPlaceholder</code>	Describes whether sum of y square pointer in the <code>VariantParamPack</code> will be NULL, or if not, user promised pointer alignment <code>*</code> .	CUDNN_PTR_NULL
X_BN_SCALEBIAS_MEANVAR_DESCRIPTOR	In the setter, the <code>*param</code> should be a pointer to a previously initialized <code>cudnnTensorDescriptor</code>	A common tensor descriptor describing the size, layout and datatype of the batchNorm trained scale, bias and statistics tensors. The shapes need to match the mode specified in CUDNN_PARAM_BN_MODE (similar to the <code>bnScaleBiasMeanVarDesc</code> field in the <code>cudnnBatchNormalization*</code> API).	NULL
X_BN_SCALE_PLACEHOLDER	In the setter, the <code>*param</code> should be a pointer to a previously initialized <code>X_PointerPlaceholder</code>	Describes whether the batchNorm trained scale pointer in the <code>VariantParamPack</code> will be NULL, or if not, user promised pointer alignment <code>*</code> . If the output of BN_EQSCALE is not needed, then this is	CUDNN_PTR_NULL

For the attribute CUDNN_FUSED_BN_FINALIZE_STATISTICS_TRAINING in cudnnFusedOp_t			
Attribute	Expected Descriptor Type Passed in, in the Setter	Description	Default Value After Creation
		not needed and may be NULL.	
X_BN_BIAS_PLACEHOLDER	In the setter, the *param should be a pointer to a previously initialized X_PointerPlaceHolder	Describes whether the batchNorm trained bias pointer in the VariantParamPack will be NULL, or if not, user promised pointer alignment *. If neither output of BN_EQSCALE or BN_EQBIAS is needed, then this is not needed and may be NULL.	CUDNN_PTR_NULL
X_BN_SAVED_MEAN_PLACEHOLDER	In the setter, the *param should be a pointer to a previously initialized X_PointerPlaceHolder	Describes whether the batchNorm saved mean pointer in the VariantParamPack will be NULL, or if not, user promised pointer alignment *. If set to CUDNN_PTR_NULL, then the computation for this output becomes a NOP.	CUDNN_PTR_NULL
X_BN_SAVED_INVSTD_PLACEHOLDER	In the setter, the *param should be a pointer to a previously initialized X_PointerPlaceHolder	Describes whether the batchNorm saved inverse standard deviation pointer in the VariantParamPack will be NULL, or if not, user promised pointer alignment *. If set to CUDNN_PTR_NULL, then the computation for this output becomes a NOP.	CUDNN_PTR_NULL
X_BN_RUNNING_MEAN_PLACEHOLDER	In the setter, the *param should be a pointer to a	Describes whether the batchNorm running mean pointer in the VariantParamPack will be NULL, or if not,	CUDNN_PTR_NULL

For the attribute CUDNN_FUSED_BN_FINALIZE_STATISTICS_TRAINING in cudnnFusedOp_t			
Attribute	Expected Descriptor Type Passed in, in the Setter	Description	Default Value After Creation
	previously initialized X_PointerPlaceHolder	user promised pointer alignment *. If set to CUDNN_PTR_NULL, then the computation for this output becomes a NOP.	
X_BN_RUNNING_VAR_PLACEHOLDER	In the setter, the *param should be a pointer to a previously initialized X_PointerPlaceHolder	Describes whether the batchNorm running variance pointer in the VariantParamPack will be NULL, or if not, user promised pointer alignment *. If set to CUDNN_PTR_NULL, then the computation for this output becomes a NOP.	CUDNN_PTR_NULL
X_BN_EQSCALEBIAS_DESC	In the setter, the *param should be a pointer to a previously initialized cudnnTensorDescriptor	Tensor descriptor describing the size, layout and datatype of the batchNorm equivalent scale and bias tensors. The shapes need to match the mode specified in CUDNN_PARAM_BN_MODE. If neither output of BN_EQSCALE or BN_EQBIAS is needed, then this is not needed and may be NULL.	NULL
X_BN_EQSCALE_PLACEHOLDER	In the setter, the *param should be a pointer to a previously initialized X_PointerPlaceHolder	Describes whether batchnorm equivalent scale pointer in the VariantParamPack will be NULL, or if not, user promised pointer alignment *. If set to CUDNN_PTR_NULL, then the computation for	CUDNN_PTR_NULL

For the attribute CUDNN_FUSED_BN_FINALIZE_STATISTICS_TRAINING in cudnnFusedOp_t			
Attribute	Expected Descriptor Type Passed in, in the Setter	Description	Default Value After Creation
		this output becomes a NOP.	
X_BN_EQBIAS_PLACEHOLDER	In the setter, the *param should be a pointer to a previously initialized X_PointerPlaceHolder	Describes whether batchnorm equivalent bias pointer in the VariantParamPack will be NULL, or if not, user promised pointer alignment *. If set to CUDNN_PTR_NULL, then the computation for this output becomes a NOP.	CUDNN_PTR_NULL

Table 29. CUDNN_FUSED_BN_FINALIZE_STATISTICS_INFERENCE

For the attribute CUDNN_FUSED_BN_FINALIZE_STATISTICS_INFERENCE in cudnnFusedOp_t			
Attribute	Expected Descriptor Type Passed in, in the Setter	Description	Default Value After Creation
X_BN_MODE	In the setter, the *param should be a pointer to a previously initialized cudnnBatchNormMode_t*	Describes the mode of operation for the scale, bias and the statistics. As of cuDNN 7.6.0, only CUDNN_BATCHNORM_SPATIAL and CUDNN_BATCHNORM_SPATIAL_PERSISTENT are supported, meaning, scale, bias and statistics are all per-channel.	CUDNN_BATCHNORM_PER_ACTIVATION
X_BN_SCALEBIAS_MEANVAR_DESCRIPTOR	In the setter, the *param should be a pointer to a previously initialized cudnnTensorDescriptor_t*	A common tensor descriptor describing the size, layout and datatype of the batchNorm trained scale, bias and statistics tensors. The	NULL

For the attribute CUDNN_FUSED_BN_FINALIZE_STATISTICS_INFERENCE in cudnnFusedOp_t

Attribute	Expected Descriptor Type Passed in, in the Setter	Description	Default Value After Creation
		shapes need to match the mode specified in CUDNN_PARAM_BN_MODE (similar to the bnScaleBiasMeanVarDesc field in the cudnnBatchNormalization* API).	
X_BN_SCALE_PLACEHOLDER	In the setter, the *param should be a pointer to a previously initialized X_PointerPlaceHolder	Describes whether the batchNorm trained scale pointer in the VariantParamPack will be NULL, or if not, user promised pointer alignment *.	CUDNN_PTR_NULL
X_BN_BIAS_PLACEHOLDER	In the setter, the *param should be a pointer to a previously initialized X_PointerPlaceHolder	Describes whether the batchNorm trained bias pointer in the VariantParamPack will be NULL, or if not, user promised pointer alignment *.	CUDNN_PTR_NULL
X_BN_RUNNING_MEAN_PLACEHOLDER	In the setter, the *param should be a pointer to a previously initialized X_PointerPlaceHolder	Describes whether the batchNorm running mean pointer in the VariantParamPack will be NULL, or if not, user promised pointer alignment *.	CUDNN_PTR_NULL
X_BN_RUNNING_VAR_PLACEHOLDER	In the setter, the *param should be a pointer to a previously initialized X_PointerPlaceHolder	Describes whether the batchNorm running variance pointer in the VariantParamPack will be NULL, or if not, user promised pointer alignment *.	CUDNN_PTR_NULL
X_BN_EQSCALEBIAS_DESC	In the setter, the *param should be a pointer to a previously initialized cudnnTensorDescriptor_t	Tensor descriptor describing the size, layout and datatype of the batchNorm equivalent scale and bias tensors. The shapes need to match the mode specified in CUDNN_PARAM_BN_MODE.	NULL

For the attribute CUDNN_FUSED_BN_FINALIZE_STATISTICS_INFERENCE in cudnnFusedOp_t			
Attribute	Expected Descriptor Type Passed in, in the Setter	Description	Default Value After Creation
X_BN_EQSCALE_PLACEHOLDER	In the setter, the *param should be a pointer to a previously initialized X_PointerPlaceHolder	Describes whether batchnorm equivalent scale pointer in the VariantParamPack will be NULL, or if not, user promised pointer alignment *. If set to CUDNN_PTR_NULL, then the computation for this output becomes a NOP.	CUDNN_PTR_NULL
X_BN_EQBIAS_PLACEHOLDER	In the setter, the *param should be a pointer to a previously initialized X_PointerPlaceHolder	Describes whether batchnorm equivalent bias pointer in the VariantParamPack will be NULL, or if not, user promised pointer alignment *. If set to CUDNN_PTR_NULL, then the computation for this output becomes a NOP.	CUDNN_PTR_NULL

Table 30. CUDNN_FUSED_CONVOLUTION_SCALE_BIAS_ADD_RELU

For the attribute CUDNN_FUSED_CONVOLUTION_SCALE_BIAS_ADD_RELU in cudnnFusedOp_t			
This operation performs the following computation, where * denotes convolution operator: $y=1 (w*x) +2 z+b$			
Attribute	Expected Descriptor Type Passed in, in the Setter	Description	Default Value After Creation
X_XDESC	In the setter, the *param should be xDesc, a pointer to a previously initialized cudnnTensorDescriptor_t.	Tensor descriptor describing the size, layout and datatype of the x (input) tensor.	NULL
X_XDATA_PLACEHOLDER	In the setter, the *param should be a pointer to a	Describes whether xData pointer in the VariantParamPack will be NULL, or if not,	CUDNN_PTR_NULL

For the attribute CUDNN_FUSED_CONVOLUTION_SCALE_BIAS_ADD_RELU in cudnnFusedOp_t
 This operation performs the following computation, where * denotes convolution operator:
 $y=1(w*x)+2 z+b$

Attribute	Expected Descriptor Type Passed in, in the Setter	Description	Default Value After Creation
	previously initialized X_PointerPlaceholder	user promised pointer alignment *.	
X_CONV_DESC	In the setter, the *param should be a pointer to a previously initialized cudnnConvolutionDescriptor_t.	Describes the convolution operation.	NULL
X_WDESC	In the setter, the *param should be a pointer to a previously initialized cudnnFilterDescriptor_t.	Filter descriptor describing the size, layout and datatype of the w (filter) tensor.	NULL
X_WDATA_PLACEHOLDER	In the setter, the *param should be a pointer to a previously initialized X_PointerPlaceholder	Describes whether w (filter) tensor pointer in the VariantParamPack will be NULL, or if not, user promised pointer alignment *.	CUDNN_PTR_NULL
X_BN_EQSCALEBIAS_DESC	In the setter, the *param should be a pointer to a previously initialized cudnnTensorDescriptor_t.	Tensor descriptor describing the size, layout and datatype of the α_1 scale and bias tensors. The tensor should have shape (1,K,1,1), K is the number of output features.	NULL
X_BN_EQSCALE_PLACEHOLDER	In the setter, the *param should be a pointer to a previously initialized X_PointerPlaceholder	Describes whether batchnorm equivalent scale or α_1 tensor pointer in the VariantParamPack will be NULL, or if not, user promised pointer alignment *. If set to CUDNN_PTR_NULL, then α_1 scaling becomes an NOP.	CUDNN_PTR_NULL
X_ZDESC	In the setter, the *param should be xDesc, a pointer to a	Tensor descriptor describing the size, layout and datatype of the z tensor.	NULL

For the attribute `CUDNN_FUSED_CONVOLUTION_SCALE_BIAS_ADD_RELU` in `cudaFusedOp_t`
 This operation performs the following computation, where `*` denotes convolution operator:
 $y = 1(w * x) + 2 z + b$

Attribute	Expected Descriptor Type Passed in, in the Setter	Description	Default Value After Creation
	previously initialized <code>cudaTensorDescriptor_t</code>	If unset, then <code>z</code> scale-add term becomes a NOP.	
<code>CUDNN_PARAM_ZDATA_PLACEMENT</code>	In the setter, the <code>*param</code> should be a pointer to a previously initialized <code>X_PointerPlaceholder_t</code>	Describes whether <code>z</code> tensor pointer in the <code>VariantParamPack</code> will be NULL, or if not, user promised pointer alignment <code>*</code> . If set to <code>CUDNN_PTR_NULL</code> , then <code>z</code> scale-add term becomes a NOP.	<code>CUDNN_PTR_NULL</code>
<code>CUDNN_PARAM_BN_Z_EQSCALE</code>	In the setter, the <code>*param</code> should be a pointer to a previously initialized <code>cudaTensorDescriptor_t</code>	Tensor descriptor describing the size, layout and datatype of the <code>a₂</code> tensor. If set to NULL then scaling for input <code>z</code> becomes a NOP.	NULLPTR
<code>CUDNN_PARAM_BN_Z_EQSCALE</code>	In the setter, the <code>*param</code> should be a pointer to a previously initialized <code>X_PointerPlaceholder_t</code>	Describes whether batchnorm <code>z</code> -equivalent scaling pointer in the <code>VariantParamPack</code> will be NULL, or if not, user promised pointer alignment <code>*</code> . If set to <code>CUDNN_PTR_NULL</code> , then the scaling for input <code>z</code> becomes a NOP.	<code>CUDNN_PTR_NULL</code>
<code>X_ACTIVATION_DESC</code>	In the setter, the <code>*param</code> should be a pointer to a previously initialized <code>cudaActivationDescriptor_t</code>	Describes the activation operation. As of 7.6.0, only activation modes of <code>CUDNN_ACTIVATION_RELU</code> and <code>CUDNN_ACTIVATION_IDENTITY</code> are supported. If set to NULL or if the activation mode is set to	NULL

For the attribute `CUDNN_FUSED_CONVOLUTION_SCALE_BIAS_ADD_RELU` in `cudaFusedOp_t`
 This operation performs the following computation, where `*` denotes convolution operator:
 $y=1(w*x)+2 z+b$

Attribute	Expected Descriptor Type Passed in, in the Setter	Description	Default Value After Creation
		<code>CUDNN_ACTIVATION_IDENTITY</code> , then the activation in the op sequence becomes a NOP.	
<code>X_YDESC</code>	In the setter, the <code>*param</code> should be a pointer to a previously initialized <code>cudaTensorDescriptor_t*</code> .	Tensor descriptor describing the size, layout and datatype of the <code>y</code> (output) tensor.	<code>NULL</code>
<code>X_YDATA_PLACEHOLDER</code>	In the setter, the <code>*param</code> should be a pointer to a previously initialized <code>X_PointerPlaceholder_t*</code>	Describes whether <code>y</code> (output) tensor pointer in the <code>VariantParamPack</code> will be <code>NULL</code> , or if not, user promised pointer alignment <code>*</code> .	<code>CUDNN_PTR_NULL</code>

6.1.3.3. `cudaFusedOpsPointerPlaceholder_t`

`cudaFusedOpsPointerPlaceholder_t` is an enumerated type used to select the alignment type of the `cudaFusedOps` descriptor pointer.

Member	Description
<code>CUDNN_PTR_NULL = 0</code>	Indicates that the pointer to the tensor in the <code>variantPack</code> will be <code>NULL</code> .
<code>CUDNN_PTR_ELEM_ALIGNED = 1</code>	Indicates that the pointer to the tensor in the <code>variantPack</code> will not be <code>NULL</code> , and will have element alignment.
<code>CUDNN_PTR_16B_ALIGNED = 2</code>	Indicates that the pointer to the tensor in the <code>variantPack</code> will not be <code>NULL</code> , and will have 16 byte alignment.

6.1.3.4. `cudaFusedOpsVariantParamLabel_t`

The `cudaFusedOpsVariantParamLabel_t` is an enumerated type that is used to set the buffer pointers. These buffer pointers can be changed in each iteration.

```
typedef enum {
    CUDNN_PTR_XDATA           = 0,
    CUDNN_PTR_BN_EQSCALE     = 1,
    CUDNN_PTR_BN_EQBIAS     = 2,
    CUDNN_PTR_WDATA         = 3,
    CUDNN_PTR_DWDATA        = 4,
    CUDNN_PTR_YDATA         = 5,
    CUDNN_PTR_DYDATA        = 6,
```

```

CUDNN_PTR_YSUM = 7,
CUDNN_PTR_YSQSUM = 8,
CUDNN_PTR_WORKSPACE = 9,
CUDNN_PTR_BN_SCALE = 10,
CUDNN_PTR_BN_BIAS = 11,
CUDNN_PTR_BN_SAVED_MEAN = 12,
CUDNN_PTR_BN_SAVED_INVSTD = 13,
CUDNN_PTR_BN_RUNNING_MEAN = 14,
CUDNN_PTR_BN_RUNNING_VAR = 15,
CUDNN_PTR_ZDATA = 16,
CUDNN_PTR_BN_Z_EQSCALE = 17,
CUDNN_PTR_BN_Z_EQBIAS = 18,
CUDNN_PTR_ACTIVATION_BITMASK = 19,
CUDNN_PTR_DXDATA = 20,
CUDNN_PTR_DZDATA = 21,
CUDNN_PTR_BN_DSCALE = 22,
CUDNN_PTR_BN_DBIAS = 23,
CUDNN_SCALAR_SIZE_T_WORKSPACE_SIZE_IN_BYTES = 100,
CUDNN_SCALAR_INT64_T_BN_ACCUMULATION_COUNT = 101,
CUDNN_SCALAR_DOUBLE_BN_EXP_AVG_FACTOR = 102,
CUDNN_SCALAR_DOUBLE_BN_EPSILON = 103,
} cudnnFusedOpsVariantParamLabel_t;

```

Table 31. Legend For Tables in This Section

Short-form used	Stands for
Setter	cudnnSetFusedOpsVariantParamPackAttribute()
Getter	cudnnGetFusedOpsVariantParamPackAttribute()
x_ prefix in the Attribute key column	Stands for CUDNN_PTR_ or CUDNN_SCALAR_ in the enumerator name.

Table 32. CUDNN_FUSED_SCALE_BIAS_ACTIVATION_CONV_BNSTATS

For the attribute CUDNN_FUSED_SCALE_BIAS_ACTIVATION_CONV_BNSTATS in cudnnFusedOp_t				
Attribute key	Expected Descriptor Type Passed in, in the Setter	I/O Type	Description	Default Value
X_XDATA	void *	input	Pointer to x (input) tensor on device, need to agree with previously set CUDNN_PARAM_XDATA_PLACEHOLDER attribute *.	NULL
X_BN_EQSCALE	void *	input	Pointer to batchnorm equivalent scale tensor on device, need to agree with previously set CUDNN_PARAM_BN_EQSCALE_PLACEHOLDER attribute *.	NULL

For the attribute CUDNN_FUSED_SCALE_BIAS_ACTIVATION_CONV_BNSTATS in cudnnFusedOp_t				
Attribute key	Expected Descriptor Type Passed in, in the Setter	I/O Type	Description	Default Value
X_BN_EQBIAS	void *	input	Pointer to batchnorm equivalent bias tensor on device, need to agree with previously set CUDNN_PARAM_BN_EQBIAS_PLACEHOLDER attribute *.	NULL
X_WDATA	void *	input	Pointer to w (filter) tensor on device, need to agree with previously set CUDNN_PARAM_WDATA_PLACEHOLDER attribute *.	NULL
X_YDATA	void *	output	Pointer to y (output) tensor on device, need to agree with previously set CUDNN_PARAM_YDATA_PLACEHOLDER attribute *.	NULL
X_YSUM	void *	output	Pointer to sum of y tensor on device, need to agree with previously set CUDNN_PARAM_YSUM_PLACEHOLDER attribute *.	NULL
X_YSQSUM	void *	output	Pointer to sum of y square tensor on device, need to agree with previously set CUDNN_PARAM_YSQSUM_PLACEHOLDER attribute *.	NULL
X_WORKSPACE	void *	input	Pointer to user allocated workspace on device. Can be NULL if the workspace size requested is 0.	NULL
X_SIZE_T_WORKSPACE_SIZE	size_t	input	Pointer to a size_t value in host memory describing the user allocated workspace size in bytes. The amount needs to be equal or larger than the amount requested in cudnnMakeFusedOpsPlan.	0

Note:

- ▶ If the corresponding pointer placeholder in `ConstParamPack` is set to `CUDNN_PTR_NULL`, then the device pointer in the `VariantParamPack` needs to be `NULL` as well

► If the corresponding pointer placeholder in `ConstParamPack` is set to `CUDNN_PTR_ELEM_ALIGNED` or `CUDNN_PTR_16B_ALIGNED`, then the device pointer in the `VariantParamPack` may not be `NULL` and needs to be at least element-aligned or 16 bytes-aligned, respectively.

Table 33. CUDNN_FUSED_SCALE_BIAS_ACTIVATION_WGRAD

For the attribute CUDNN_FUSED_SCALE_BIAS_ACTIVATION_WGRAD in cudnnFusedOp_t				
Attribute key	Expected Descriptor Type Passed in, in the Setter	I/O Type	Description	Default Value
X_XDATA	void *	input	Pointer to x (input) tensor on device, need to agree with previously set CUDNN_PARAM_XDATA_PLACEHOLDER attribute *.	NULL
X_BN_EQSCALE	void *	input	Pointer to batchnorm equivalent scale tensor on device, need to agree with previously set CUDNN_PARAM_BN_EQSCALE_PLACEHOLDER attribute *.	NULL
X_BN_EQBIAS	void *	input	Pointer to batchnorm equivalent bias tensor on device, need to agree with previously set CUDNN_PARAM_BN_EQBIAS_PLACEHOLDER attribute *.	NULL
X_DWDATA	void *	output	Pointer to dw (filter gradient output) tensor on device, need to agree with previously set CUDNN_PARAM_WDATA_PLACEHOLDER attribute *.	NULL
X_DYDATA	void *	input	Pointer to dy (gradient input) tensor on device, need to agree with previously set CUDNN_PARAM_YDATA_PLACEHOLDER attribute *.	NULL
X_WORKSPACE	void *	input	Pointer to user allocated workspace on device. Can be NULL if the workspace size requested is 0.	NULL
X_SIZE_T_WORKSPACE_SIZE_IN_BYTES	size_t *	input	Pointer to a size_t value in host memory describing the	0

For the attribute `CUDNN_FUSED_SCALE_BIAS_ACTIVATION_WGRAD` in `cudaFusedOp_t`

Attribute key	Expected Descriptor Type Passed in, in the Setter	I/O Type	Description	Default Value
			user allocated workspace size in bytes. The amount needs to be equal or larger than the amount requested in <code>cudaMakeFusedOpsPlan</code> .	

Note:

- ▶ If the corresponding pointer placeholder in `ConstParamPack` is set to `CUDNN_PTR_NULL`, then the device pointer in the `VariantParamPack` needs to be `NULL` as well.
- ▶ If the corresponding pointer placeholder in `ConstParamPack` is set to `CUDNN_PTR_ELEM_ALIGNED` or `CUDNN_PTR_16B_ALIGNED`, then the device pointer in the `VariantParamPack` may not be `NULL` and needs to be at least element-aligned or 16 bytes-aligned, respectively.

Table 34. `CUDNN_FUSED_BN_FINALIZE_STATISTICS_TRAINING`

For the attribute `CUDNN_FUSED_BN_FINALIZE_STATISTICS_TRAINING` in `cudaFusedOp_t`

Attribute key	Expected Descriptor Type Passed in, in the Setter	I/O Type	Description	Default Value
<code>X_YSUM</code>	<code>void *</code>	input	Pointer to sum of <code>y</code> tensor on device, need to agree with previously set <code>CUDNN_PARAM_YSUM_PLACEHOLDER</code> attribute *.	<code>NULL</code>
<code>X_YSQSUM</code>	<code>void *</code>	input	Pointer to sum of <code>y</code> square tensor on device, need to agree with previously set <code>CUDNN_PARAM_YSQSUM_PLACEHOLDER</code> attribute *.	<code>NULL</code>
<code>X_BN_SCALE</code>	<code>void *</code>	input	Pointer to sum of <code>y</code> square tensor on device, need to agree with previously set <code>CUDNN_PARAM_BN_SCALE_PLACEHOLDER</code> attribute *.	<code>NULL</code>

For the attribute CUDNN_FUSED_BN_FINALIZE_STATISTICS_TRAINING in cudnnFusedOp_t				
Attribute key	Expected Descripto Type Passed in, in the Setter	I/O Type	Description	Default Value
X_BN_BIAS	void *	input	Pointer to sum of y square tensor on device, need to agree with previously set CUDNN_PARAM_BN_BIAS_PLACEHOLDER attribute *.	NULL
X_BN_SAVED_MEAN	void *	output	Pointer to sum of y square tensor on device, need to agree with previously set CUDNN_PARAM_BN_SAVED_MEAN_PLACEHOLDER attribute *.	NULL
X_BN_SAVED_INVSTD	void *	output	Pointer to sum of y square tensor on device, need to agree with previously set CUDNN_PARAM_BN_SAVED_INVSTD_PLACEHOLDER attribute *.	NULL
X_BN_RUNNING_MEAN	void *	input/output	Pointer to sum of y square tensor on device, need to agree with previously set CUDNN_PARAM_BN_RUNNING_MEAN_PLACEHOLDER attribute *.	NULL
X_BN_RUNNING_VAR	void *	input/output	Pointer to sum of y square tensor on device, need to agree with previously set CUDNN_PARAM_BN_RUNNING_VAR_PLACEHOLDER attribute *.	NULL
X_BN_EQSCALE	void *	output	Pointer to batchnorm equivalent scale tensor on device, need to agree with previously set CUDNN_PARAM_BN_EQSCALE_PLACEHOLDER attribute *.	NULL
X_BN_EQBIAS	void *	output	Pointer to batchnorm equivalent bias tensor on device, need to agree with previously set CUDNN_PARAM_BN_EQBIAS_PLACEHOLDER attribute *.	NULL
X_INT64_T_BN_ACCUMULATION_COUNT	int64_t *	input	Pointer to a scalar value in int64_t on host memory. This value should describe the number of tensor elements accumulated in the sum of y and sum of y square tensors.	0

For the attribute CUDNN_FUSED_BN_FINALIZE_STATISTICS_TRAINING in cudnnFusedOp_t				
Attribute key	Expected Descripto Type Passed in, in the Setter	I/O Type	Description	Default Value
			<p>For example, in the single GPU use case, if the mode is CUDNN_BATCHNORM_SPATIAL or CUDNN_BATCHNORM_SPATIAL_PERSISTENT, the value should be equal to N*H*W of the tensor from which the statistics are calculated.</p> <p>In multi-GPU use case, if all-reduce has been performed on the sum of y and sum of y square tensors, this value should be the sum of the single GPU accumulation count on each of the GPUs.</p>	
X_DOUBLE_BN_EXP_AVG_FACTOR	double *	input	<p>Pointer to a scalar value in double on host memory.</p> <p>Factor used in the moving average computation. See exponentialAverageFactor in cudnnBatchNormalization* APIs.</p>	0.0
X_DOUBLE_BN_EPSILON	double *	input	<p>Pointer to a scalar value in double on host memory.</p> <p>A conditioning constant used in the batch normalization formula. Its value should be equal to or greater than the value defined for CUDNN_BN_MIN_EPSILON in cudnn.h.</p> <p>See exponentialAverageFactor in cudnnBatchNormalization* APIs.</p>	0.0
X_WORKSPACE	void *	input	<p>Pointer to user allocated workspace on device. Can be NULL if the workspace size requested is 0.</p>	NULL
X_SIZE_T_WORKSPACE_SIZE_IN_BYTES	size_t *	input	<p>Pointer to a size_t value in host memory describing the user allocated workspace</p>	0

For the attribute `CUDNN_FUSED_BN_FINALIZE_STATISTICS_TRAINING` in `cudaFusedOp_t`

Attribute key	Expected Descripto Type Passed in, in the Setter	I/O Type	Description	Default Value
			size in bytes. The amount needs to be equal or larger than the amount requested in <code>cudaMakeFusedOpsPlan</code> .	

Note:

- ▶ If the corresponding pointer placeholder in `ConstParamPack` is set to `CUDNN_PTR_NULL`, then the device pointer in the `VariantParamPack` needs to be `NULL` as well.
- ▶ If the corresponding pointer placeholder in `ConstParamPack` is set to `CUDNN_PTR_ELEM_ALIGNED` or `CUDNN_PTR_16B_ALIGNED`, then the device pointer in the `VariantParamPack` may not be `NULL` and needs to be at least element-aligned or 16 bytes-aligned, respectively.

Table 35. `CUDNN_FUSED_BN_FINALIZE_STATISTICS_INFERENCE`

For the attribute `CUDNN_FUSED_BN_FINALIZE_STATISTICS_INFERENCE` in `cudaFusedOp_t`

Attribute key	Expected Descripto Type Passed in, in the Setter	I/O Type	Description	Default Value
<code>X_BN_SCALE</code>	<code>void *</code>	input	Pointer to sum of y square tensor on device, need to agree with previously set <code>CUDNN_PARAM_BN_SCALE_PLACEHOLDER</code> attribute *.	<code>NULL</code>
<code>X_BN_BIAS</code>	<code>void *</code>	input	Pointer to sum of y square tensor on device, need to agree with previously set <code>CUDNN_PARAM_BN_BIAS_PLACEHOLDER</code> attribute *.	<code>NULL</code>
<code>X_BN_RUNNING_MEAN</code>	<code>void *</code>	input/output	Pointer to sum of y square tensor on device, need to agree with previously set <code>CUDNN_PARAM_BN_RUNNING_MEAN_PLACEHOLDER</code> attribute *.	<code>NULL</code>
<code>X_BN_RUNNING_VAR</code>	<code>void *</code>	input/output	Pointer to sum of y square tensor on device, need to	<code>NULL</code>

For the attribute CUDNN_FUSED_BN_FINALIZE_STATISTICS_INFERENCE in cudnnFusedOp_t

Attribute key	Expected Descripto Type Passed in, in the Setter	I/O Type	Description	Default Value
			agree with previously set CUDNN_PARAM_BN_RUNNING_VAR_PLACEHOLDER attribute *.	
X_BN_EQSCALE	void *	output	Pointer to batchnorm equivalent scale tensor on device, need to agree with previously set CUDNN_PARAM_BN_EQSCALE_PLACEHOLDER attribute *.	NULL
X_BN_EQBIAS	void *	output	Pointer to batchnorm equivalent bias tensor on device, need to agree with previously set CUDNN_PARAM_BN_EQBIAS_PLACEHOLDER attribute *.	NULL
X_DOUBLE_BN_EPSILON	double *	input	Pointer to a scalar value in double on host memory. A conditioning constant used in the batch normalization formula. Its value should be equal to or greater than the value defined for CUDNN_BN_MIN_EPSILON in cudnn.h. See exponentialAverageFactor in cudnnBatchNormalization* APIs.	0.0
X_WORKSPACE	void *	input	Pointer to user allocated workspace on device. Can be NULL if the workspace size requested is 0.	NULL
X_SIZE_T_WORKSPACE_SIZE_IN_BYTES	size_t *	input	Pointer to a size_t value in host memory describing the user allocated workspace size in bytes. The amount needs to be equal or larger than the amount requested in cudnnMakeFusedOpsPlan.	0

Note:

- ▶ If the corresponding pointer placeholder in ConstParamPack is set to CUDNN_PTR_NULL, then the device pointer in the VariantParamPack needs to be NULL as well.

► If the corresponding pointer placeholder in `ConstParamPack` is set to `CUDNN_PTR_ELEM_ALIGNED` or `CUDNN_PTR_16B_ALIGNED`, then the device pointer in the `VariantParamPack` may not be `NULL` and needs to be at least element-aligned or 16 bytes-aligned, respectively.

Table 36. CUDNN_FUSED_SCALE_BIAS_ADD_RELU

For the attribute <code>CUDNN_FUSED_BN_FINALIZE_STATISTICS_INFERENCE</code> in <code>cudaFusedOp_t</code>				
Attribute key	Expected Descriptor Type Passed in, in the Setter	I/O Type	Description	Default Value
<code>X_XDATA</code>	<code>void *</code>	input	Pointer to <code>x</code> (image) tensor on device, need to agree with previously set <code>CUDNN_PARAM_XDATA_PLACEHOLDER</code> attribute *.	<code>NULL</code>
<code>X_WDATA</code>	<code>void *</code>	input	Pointer to <code>w</code> (filter) tensor on device, need to agree with previously set <code>CUDNN_PARAM_WDATA_PLACEHOLDER</code> attribute *.	<code>NULL</code>
<code>X_BN_EQSCALE</code>	<code>void *</code>	input	Pointer to <code>alpha1</code> or batchnorm equivalent scale tensor on device; need to agree with previously set <code>CUDNN_PARAM_BN_EQSCALE_PLACEHOLDER</code> attribute *.	<code>NULL</code>
<code>X_ZDATA</code>	<code>void *</code>	input	Pointer to <code>z</code> (tensor on device; Need to agree with previously set <code>CUDNN_PARAM_YDATA_PLACEHOLDER</code> attribute *.	<code>NULL</code>
<code>X_BN_Z_EQSCALE</code>	<code>void *</code>	input	Pointer to <code>alpha2</code> , equivalent scale tensor for <code>z</code> ; Need to agree with previously set <code>CUDNN_PARAM_BN_Z_EQSCALE_PLACEHOLDER</code> attribute *.	<code>NULL</code>
<code>X_BN_Z_EQBIAS</code>	<code>void *</code>	input	Pointer to batchnorm equivalent bias	<code>NULL</code>

For the attribute `CUDNN_FUSED_BN_FINALIZE_STATISTICS_INFERENCE` in `cudaFusedOp_t`

Attribute key	Expected Descriptor Type Passed in, in the Setter	I/O Type	Description	Default Value
			tensor on device, need to agree with previously set <code>CUDNN_PARAM_BN_Z_EQBIAS_PLACEHOLDER</code> attribute *.	
<code>X_YDATA</code>	<code>void *</code>	output	Pointer to <code>y</code> (output) tensor on device, need to agree with previously set <code>CUDNN_PARAM_YDATA_PLACEHOLDER</code> attribute *.	<code>NULL</code>
<code>X_WORKSPACE</code>	<code>void *</code>	input	Pointer to user allocated workspace on device. Can be <code>NULL</code> if the workspace size requested is 0.	<code>NULL</code>
<code>X_SIZE_T_WORKSPACE_SIZE_IN_BYTES</code>	<code>size_t *</code>	input	Pointer to a <code>size_t</code> value in host memory describing the user allocated workspace size in bytes. The amount needs to be equal or larger than the amount requested in <code>cudaMakeFusedOpsPlan</code> .	0

Note:

- ▶ If the corresponding pointer placeholder in `ConstParamPack` is set to `CUDNN_PTR_NULL`, then the device pointer in the `VariantParamPack` needs to be `NULL` as well.
- ▶ If the corresponding pointer placeholder in `ConstParamPack` is set to `CUDNN_PTR_ELEM_ALIGNED` or `CUDNN_PTR_16B_ALIGNED`, then the device pointer in the `VariantParamPack` may not be `NULL` and needs to be at least element-aligned or 16 bytes-aligned, respectively.

6.2. API Functions

6.2.1. cudnnConvolutionBackwardBias ()

```

cudnnStatus_t cudnnConvolutionBackwardBias (
    cudnnHandle_t          handle,
    const void             *alpha,
    const cudnnTensorDescriptor_t dyDesc,
    const void             *dy,
    const void             *beta,
    const cudnnTensorDescriptor_t dbDesc,
    void                  *db)
    
```

This function computes the convolution function gradient with respect to the bias, which is the sum of every element belonging to the same feature map across all of the images of the input tensor. Therefore, the number of elements produced is equal to the number of features maps of the input tensor.

Parameters

handle

Input. Handle to a previously created cuDNN context. For more information, see [cudnnHandle_t](#).

alpha, beta

Input. Pointers to scaling factors (in host memory) used to blend the computation result with prior value in the output layer as follows:

```
dstValue = alpha[0]*resultValue + beta[0]*priorDstValue
```

For more information, see [Scaling Parameters](#) in the *cuDNN Developer Guide*.

dyDesc

Input. Handle to the previously initialized input tensor descriptor. For more information, see [cudnnTensorDescriptor_t](#).

dy

Input. Data pointer to GPU memory associated with the tensor descriptor dyDesc.

dbDesc

Input. Handle to the previously initialized output tensor descriptor.

db

Output. Data pointer to GPU memory associated with the output tensor descriptor dbDesc.

Returns

CUDNN_STATUS_SUCCESS

The operation was launched successfully.

CUDNN_STATUS_NOT_SUPPORTED

The function does not support the provided configuration.

CUDNN_STATUS_BAD_PARAM

At least one of the following conditions are met:

- ▶ One of the parameters *n*, *height*, *width* of the output tensor is not 1.
- ▶ The numbers of feature maps of the input tensor and output tensor differ.
- ▶ The *dataType* of the two tensor descriptors is different.

6.2.2. cudnnConvolutionBackwardFilter()

```

cudnnStatus_t cudnnConvolutionBackwardFilter(
    cudnnHandle_t          handle,
    const void             *alpha,
    const cudnnTensorDescriptor_t xDesc,
    const void             *x,
    const cudnnTensorDescriptor_t dyDesc,
    const void             *dy,
    const cudnnConvolutionDescriptor_t convDesc,
    cudnnConvolutionBwdFilterAlgo_t algo,
    void                   *workSpace,
    size_t                 workSpaceSizeInBytes,
    const void             *beta,
    const cudnnFilterDescriptor_t dwDesc,
    void                   *dw)
    
```

This function computes the convolution weight (filter) gradient of the tensor *dy*, where *y* is the output of the forward convolution in [cudnnConvolutionForward\(\)](#). It uses the specified *algo*, and returns the results in the output tensor *dw*. Scaling factors *alpha* and *beta* can be used to scale the computed result or accumulate with the current *dw*.

Parameters

handle

Input. Handle to a previously created cuDNN context. For more information, see [cudnnHandle_t](#).

alpha, beta

Input. Pointers to scaling factors (in host memory) used to blend the computation result with prior value in the output layer as follows:

```
dstValue = alpha[0]*result + beta[0]*priorDstValue
```

For more information, see [Scaling Parameters](#) in the *cuDNN Developer Guide*.

xDesc

Input. Handle to a previously initialized tensor descriptor. For more information, see [cudnnTensorDescriptor_t](#).

x

Input. Data pointer to GPU memory associated with the tensor descriptor *xDesc*.

dyDesc

Input. Handle to the previously initialized input differential tensor descriptor.

dy

Input. Data pointer to GPU memory associated with the backpropagation gradient tensor descriptor `dyDesc`.

convDesc

Input. Previously initialized convolution descriptor. For more information, see [cudaConvolutionDescriptor_t](#).

algo

Input. Enumerant that specifies which convolution algorithm should be used to compute the results. For more information, see [cudaConvolutionBwdFilterAlgo_t](#).

workSpace

Input. Data pointer to GPU memory to a workspace needed to be able to execute the specified algorithm. If no workspace is needed for a particular algorithm, that pointer can be nil.

workSpaceSizeInBytes

Input. Specifies the size in bytes of the provided `workSpace`.

dwDesc

Input. Handle to a previously initialized filter gradient descriptor. For more information, see [cudaFilterDescriptor_t](#).

dw

Input/Output. Data pointer to GPU memory associated with the filter gradient descriptor `dwDesc` that carries the result.

Supported configurations

This function supports the following combinations of data types for `xDesc`, `dyDesc`, `convDesc`, and `dwDesc`.

Data Type Configurations	<code>xDesc</code> , <code>dyDesc</code> , and <code>dwDesc</code> Data Type	<code>convDesc</code> Data Type
TRUE_HALF_CONFIG (only supported on architectures with true FP16 support, meaning, compute capability 5.3 and later)	CUDNN_DATA_HALF	CUDNN_DATA_HALF
PSEUDO_HALF_CONFIG	CUDNN_DATA_HALF	CUDNN_DATA_FLOAT
PSEUDO_BFLOAT16_CONFIG	CUDNN_DATA_BFLOAT16	CUDNN_DATA_FLOAT
FLOAT_CONFIG	CUDNN_DATA_FLOAT	CUDNN_DATA_FLOAT
DOUBLE_CONFIG	CUDNN_DATA_DOUBLE	CUDNN_DATA_DOUBLE

Supported algorithms



Note: Specifying a separate algorithm can cause changes in performance, support and computation determinism. See the following table for an exhaustive list of algorithm options and their respective supported parameters and deterministic behavior.

The table below shows the list of the supported 2D and 3D convolutions. The 2D convolutions are described first, followed by the 3D convolutions.

For the following terms, the short-form versions shown in the parentheses are used in the table below, for brevity:

- ▶ CUDNN_CONVOLUTION_BWD_FILTER_ALGO_0 (**_ALGO_0**)
- ▶ CUDNN_CONVOLUTION_BWD_FILTER_ALGO_1 (**_ALGO_1**)
- ▶ CUDNN_CONVOLUTION_BWD_FILTER_ALGO_3 (**_ALGO_3**)
- ▶ CUDNN_CONVOLUTION_BWD_FILTER_ALGO_FFT (**_FFT**)
- ▶ CUDNN_CONVOLUTION_BWD_FILTER_ALGO_FFT_TILING (**_FFT_TILING**)
- ▶ CUDNN_CONVOLUTION_BWD_FILTER_ALGO_WINOGRAD_NONFUSED (**_WINOGRAD_NONFUSED**)
- ▶ CUDNN_TENSOR_NCHW (**_NCHW**)
- ▶ CUDNN_TENSOR_NHWC (**_NHWC**)
- ▶ CUDNN_TENSOR_NCHW_VECT_C (**_NCHW_VECT_C**)

Table 37. For 2D convolutions: dwDesc: `_NHWC`

Filter descriptor dwDesc: <code>_NHWC</code> (see cudnnTensorFormat_t)					
Algo Name	Deterministic (Yes or No)	Tensor Formats Supported for dyDesc	Tensor Formats Supported for dxDesc	Data Type Configurations Supported	Important
<code>_ALGO_0</code> and <code>_ALGO_1</code>		All except <code>_NCHW_VECT_C</code>	NHWC HWC-packed	<code>PSEUDO_HALF_CONFIG</code> <code>PSEUDO_BFLOAT16_CONFIG</code> <code>FLOAT_CONFIG</code>	

Table 38. For 2D convolutions: dwDesc: _NCHW

Filter descriptor dwDesc: _NCHW					
Algo Name	Deterministic (Yes or No)	Tensor Formats Supported for dyDesc	Tensor Formats Supported for dxDesc	Data Type Configurations Supported	Important
_ALGO_0	No	All except _NCHW_VECT_C	NCHW CHW-packed	PSEUDO_HALF_CONFIG PSEUDO_BFLOAT16_CONFIG FLOAT_CONFIG DOUBLE_CONFIG	Dilation: greater than 0 for all dimensions convDesc Group Count Support: Greater than 0
_ALGO_1	No	All except _NCHW_VECT_C	NCHW CHW-packed	PSEUDO_HALF_CONFIG PSEUDO_BFLOAT16_CONFIG FLOAT_CONFIG DOUBLE_CONFIG	Dilation: greater than 0 for all dimensions convDesc Group Count Support: Greater than 0
_FFT	Yes	NCHW CHW-packed	NCHW CHW-packed	PSEUDO_HALF_CONFIG FLOAT_CONFIG	Dilation: 1 for all dimensions convDesc Group Count Support: Greater than 0 xDesc feature map height + 2 * convDesc zero-padding height must equal 256 or less xDesc feature map width + 2 * convDesc zero-padding

Filter descriptor <code>dwDesc: _NCHW</code>					
Algo Name	Deterministic (Yes or No)	Tensor Formats Supported for <code>dyDesc</code>	Tensor Formats Supported for <code>dxDesc</code>	Data Type Configurations Supported	Important
					width must equal 256 or less convDesc vertical and horizontal filter stride must equal 1 dwDesc filter height must be greater than convDesc zero-padding height dwDesc filter width must be greater than convDesc zero-padding width
<code>_ALGO_3</code>	Yes	All except <code>_NCHW_VECT_C</code>	NCHW CHW-packed	<code>PSEUDO_HALF_CONFIG</code> <code>FLOAT_CONFIG</code> <code>DOUBLE_CONFIG</code>	Dilation: 1 for all dimensions convDesc Group Count Support: Greater than 0
<code>_WINOGRAD_NONPadded</code>	Yes	All except <code>_NCHW_VECT_C</code>	NCHW CHW-packed	<code>TRUE_HALF_CONFIG</code> <code>PSEUDO_HALF_CONFIG</code> <code>PSEUDO_BFLOAT16_CONFIG</code> <code>FLOAT_CONFIG</code>	Dilation: 1 for all dimensions convDesc Group Count Support: Greater than 0 convDesc vertical and

Filter descriptor dwDesc: _NCHW					
Algo Name	Deterministic (Yes or No)	Tensor Formats Supported for dyDesc	Tensor Formats Supported for dxDesc	Data Type Configurations Supported	Important
					horizontal filter stride must equal 1 dwDesc filter (height, width) must be (3,3) or (5,5) If dwDesc filter (height, width) is (5,5), then the data type config TRUE_HALF_CONFIG is not supported.
_FFT_TILING	Yes	NCHW CHW-packed	NCHW CHW-packed	PSEUDO_HALF_CONFIG FLOAT_CONFIG DOUBLE_CONFIG	Dilation: 1 for all dimensions convDesc Group Count Support: Greater than 0 dyDesc width or height must equal 1 (the same dimension as in xDesc). The other dimension must be less than or equal to 256, meaning, the largest 1D tile size currently supported.

Filter descriptor <code>dwDesc: _NCHW</code>					
Algo Name	Deterministic (Yes or No)	Tensor Formats Supported for <code>dyDesc</code>	Tensor Formats Supported for <code>dxDesc</code>	Data Type Configurations Supported	Important
					<p><code>convDesc</code> vertical and horizontal filter stride must equal 1</p> <p><code>dwDesc</code> filter height must be greater than <code>convDesc</code> zero-padding height</p> <p><code>dwDesc</code> filter width must be greater than <code>convDesc</code> zero-padding width</p>

Table 39. For 3D convolutions: `dwDesc: _NCHW`

Filter descriptor <code>dwDesc: _NCHW</code> .					
Algo Name (3D Convolutions)	Deterministic (Yes or No)	Tensor Formats Supported for <code>dyDesc</code>	Tensor Formats Supported for <code>dxDesc</code>	Data Type Configurations Supported	Important
<code>_ALGO_0</code>	No	All except <code>_NCDHW_VECT_C</code>	NCDHW CDHW-packed	<p><code>PSEUDO_HALF_CONFIG</code></p> <p><code>PSEUDO_BFLOAT16_CONFIG</code></p> <p><code>FLOAT_CONFIG</code></p> <p><code>DOUBLE_CONFIG</code></p>	<p>Dilation: greater than 0 for all dimensions</p> <p><code>convDesc</code> Group Count Support: Greater than 0</p>
<code>_ALGO_3</code>	No	NCDHW fully-packed	NCDHW fully-packed	<p><code>PSEUDO_HALF_CONFIG</code></p> <p><code>FLOAT_CONFIG</code></p>	<p>Dilation: greater than</p>

Filter descriptor <code>dwDesc: _NCHW</code> .					
Algo Name (3D Convolutions)	Deterministic (Yes or No)	Tensor Formats Supported for <code>dyDesc</code>	Tensor Formats Supported for <code>dxDesc</code>	Data Type Configurations Supported	Important
				DOUBLE_CONFIG	0 for all dimensions convDesc Group Count Support: Greater than 0

Table 40. For 3D convolutions: `dwDesc: _NHWC`

Filter descriptor <code>dwDesc: _NHWC</code> .					
Algo Name (3D Convolutions)	Deterministic (Yes or No)	Tensor Formats Supported for <code>xDesc</code>	Tensor Formats Supported for <code>dyDesc</code>	Data Type Configurations Supported	Important
<code>_ALGO_1</code>	No	NDHWC HWC-packed	NDHWC HWC-packed	PSEUDO_HALF_CONFIG PSEUDO_BFLOTT16_CONFIG FLOAT_CONFIG TRUE_HALF_CONFIG	Dilation: greater than 0 for all dimensions convDesc Group Count Support: Greater than 0

Returns

CUDNN_STATUS_SUCCESS

The operation was launched successfully.

CUDNN_STATUS_BAD_PARAM

At least one of the following conditions are met:

- ▶ At least one of the following is NULL: `handle`, `xDesc`, `dyDesc`, `convDesc`, `dwDesc`, `xData`, `dyData`, `dwData`, `alpha`, `beta`
- ▶ `xDesc` and `dyDesc` have a non-matching number of dimensions
- ▶ `xDesc` and `dwDesc` have a non-matching number of dimensions
- ▶ `xDesc` has fewer than three number of dimensions

- ▶ xDesc, dyDesc, and dwDesc have a non-matching data type.
- ▶ xDesc and dwDesc have a non-matching number of input feature maps per image (or group in case of grouped convolutions).
- ▶ yDesc or dwDesc indicate an output channel count that isn't a multiple of group count (if group count has been set in convDesc).

CUDNN_STATUS_NOT_SUPPORTED

At least one of the following conditions are met:

- ▶ xDesc or dyDesc have negative tensor striding
- ▶ xDesc, dyDesc or dwDesc has a number of dimensions that is not 4 or 5
- ▶ The chosen algo does not support the parameters provided; see above for exhaustive list of parameter support for each algo

CUDNN_STATUS_MAPPING_ERROR

An error occurs during the texture object creation associated with the filter data.

CUDNN_STATUS_EXECUTION_FAILED

The function failed to launch on the GPU.

6.2.3. cudnnCreateFusedOpsConstParamPack ()

```

cudnnStatus_t cudnnCreateFusedOpsConstParamPack(
    cudnnFusedOpsConstParamPack_t *constPack,
    cudnnFusedOps_t ops);
    
```

This function creates an opaque structure to store the various problem size information, such as the shape, layout and the type of tensors, and the descriptors for convolution and activation, for the selected sequence of cudnnFusedOps computations.

Parameters

constPack

Input. The opaque structure that is created by this function. For more information, see [cudnnFusedOpsConstParamPack_t](#).

ops

Input. The specific sequence of computations to perform in the cudnnFusedOps computations, as defined in the enumerant type [cudnnFusedOps_t](#).

Returns

CUDNN_STATUS_BAD_PARAM

If either constPack or ops is NULL.

CUDNN_STATUS_SUCCESS

If the descriptor is created successfully.

CUDNN_STATUS_NOT_SUPPORTED

If the ops enum value is not supported or reserved for future use.

6.2.4. cudnnCreateFusedOpsPlan ()

```

cudnnStatus_t cudnnCreateFusedOpsPlan(
    cudnnFusedOpsPlan_t *plan,
    cudnnFusedOps_t ops);

```

This function creates the plan descriptor for the `cudnnFusedOps` computation. This descriptor contains the plan information, including the problem type and size, which kernels should be run, and the internal workspace partition.

Parameters

plan

Input. A pointer to the instance of the descriptor created by this function.

ops

Input. The specific sequence of fused operations computations for which this plan descriptor should be created. For more information, see [cudnnFusedOps_t](#).

Returns

CUDNN_STATUS_BAD_PARAM

If either the input `*plan` is NULL or the `ops` input is not a valid `cudnnFusedOp` enum.

CUDNN_STATUS_NOT_SUPPORTED

The `ops` input provided is not supported.

CUDNN_STATUS_SUCCESS

The plan descriptor is created successfully.

6.2.5. cudnnCreateFusedOpsVariantParamPack ()

```

cudnnStatus_t cudnnCreateFusedOpsVariantParamPack(
    cudnnFusedOpsVariantParamPack_t *varPack,
    cudnnFusedOps_t ops);

```

This function creates a descriptor for `cudnnFusedOps` constant parameters.

Parameters

varPack

Input. Pointer to the descriptor created by this function. For more information, see [cudnnFusedOpsVariantParamPack_t](#).

ops

Input. The specific sequence of fused operations computations for which this descriptor should be created.

Returns

CUDNN_STATUS_SUCCESS

The descriptor is successfully created.

CUDNN_STATUS_BAD_PARAM

If any input is invalid.

6.2.6. cudnnDestroyFusedOpsConstParamPack ()

```
cudaStatus_t cudnnDestroyFusedOpsConstParamPack(
    cudnnFusedOpsConstParamPack_t constPack);
```

This function destroys a previously-created `cudnnFusedOpsConstParamPack_t` structure.

Parameters

constPack

Input. The `cudnnFusedOpsConstParamPack_t` structure that should be destroyed.

Returns

CUDNN_STATUS_SUCCESS

If the descriptor is destroyed successfully.

CUDNN_STATUS_INTERNAL_ERROR

If the ops enum value is not supported or invalid.

6.2.7. cudnnDestroyFusedOpsPlan ()

```
cudaStatus_t cudnnDestroyFusedOpsPlan(
    cudnnFusedOpsPlan_t plan);
```

This function destroys the plan descriptor provided.

Parameters

plan

Input. The descriptor that should be destroyed by this function.

Returns

CUDNN_STATUS_SUCCESS

If either the plan descriptor is NULL or the descriptor is successfully destroyed.

6.2.8. cudnnDestroyFusedOpsVariantParamPack ()

```
cudaStatus_t cudnnDestroyFusedOpsVariantParamPack(
    cudnnFusedOpsVariantParamPack_t varPack);
```

This function destroys a previously-created descriptor for `cudnnFusedOps` constant parameters.

Parameters

varPack

Input. The descriptor that should be destroyed.

Returns

CUDNN_STATUS_SUCCESS

The descriptor is successfully destroyed.

6.2.9. cudnnFindConvolutionBackwardFilterAlgorithm()

```

cudnnStatus_t cudnnFindConvolutionBackwardFilterAlgorithm(
cudnnHandle_t handle,
const cudnnTensorDescriptor_t xDesc,
const cudnnTensorDescriptor_t dyDesc,
const cudnnConvolutionDescriptor_t convDesc,
const cudnnFilterDescriptor_t dwDesc,
const int requestedAlgoCount,
int *returnedAlgoCount,
cudnnConvolutionBwdFilterAlgoPerf_t *perfResults)
    
```

This function attempts all algorithms available for [cudnnConvolutionBackwardFilter\(\)](#). It will attempt both the provided convDesc mathType and CUDNN_DEFAULT_MATH (assuming the two differ).

Note: Algorithms without the CUDNN_TENSOR_OP_MATH availability will only be tried with CUDNN_DEFAULT_MATH, and returned as such.

Memory is allocated via `cudaMalloc()`. The performance metrics are returned in the user-allocated array of `cudnnConvolutionBwdFilterAlgoPerf_t`. These metrics are written in a sorted fashion where the first element has the lowest compute time. The total number of resulting algorithms can be queried through the API [cudnnGetConvolutionBackwardFilterAlgorithmMaxCount\(\)](#).

Note:

- ▶ This function is host blocking.
- ▶ It is recommended to run this function prior to allocating layer data; doing otherwise may needlessly inhibit some algorithm options due to resource usage.

Parameters

handle

Input. Handle to a previously created cuDNN context.

xDesc

Input. Handle to the previously initialized input tensor descriptor.

dyDesc

Input. Handle to the previously initialized input differential tensor descriptor.

convDesc

Input. Previously initialized convolution descriptor.

dwDesc

Input. Handle to a previously initialized filter descriptor.

requestedAlgoCount

Input. The maximum number of elements to be stored in perfResults.

returnedAlgoCount

Output. The number of output elements stored in perfResults.

perfResults

Output. A user-allocated array to store performance metrics sorted ascending by compute time.

Returns

CUDNN_STATUS_SUCCESS

The query was successful.

CUDNN_STATUS_BAD_PARAM

At least one of the following conditions are met:

- ▶ handle is not allocated properly.
- ▶ xDesc, dyDesc, or dwDesc are not allocated properly.
- ▶ xDesc, dyDesc, or dwDesc has fewer than 1 dimension.
- ▶ Either returnedCount or perfResults is nil.
- ▶ requestedCount is less than 1.

CUDNN_STATUS_ALLOC_FAILED

This function was unable to allocate memory to store sample input, filters and output.

CUDNN_STATUS_INTERNAL_ERROR

At least one of the following conditions are met:

- ▶ The function was unable to allocate necessary timing objects.
- ▶ The function was unable to deallocate necessary timing objects.
- ▶ The function was unable to deallocate sample input, filters and output.

6.2.10. cudnnFindConvolutionBackwardFilterAlgorithmEx

```

cudnnStatus_t cudnnFindConvolutionBackwardFilterAlgorithmEx(
    cudnnHandle_t          handle,
    const cudnnTensorDescriptor_t xDesc,
    const void             *x,
    const cudnnTensorDescriptor_t dyDesc,
    const void             *dy,
    const cudnnConvolutionDescriptor_t convDesc,
    const cudnnFilterDescriptor_t dwDesc,
    void                  *dw,
    const int              requestedAlgoCount,

```

```

int          *returnedAlgoCount,
cudnnConvolutionBwdFilterAlgoPerf_t *perfResults,
void        *workSpace,
size_t      workspaceSizeInBytes)

```

This function attempts all algorithms available for [cudnnConvolutionBackwardFilter\(\)](#). It will attempt both the provided `convDesc` `mathType` and `CUDNN_DEFAULT_MATH` (assuming the two differ).



Note: Algorithms without the `CUDNN_TENSOR_OP_MATH` availability will only be tried with `CUDNN_DEFAULT_MATH`, and returned as such.

Memory is allocated via `cudaMalloc()`. The performance metrics are returned in the user-allocated array of [cudnnConvolutionBwdFilterAlgoPerf_t](#). These metrics are written in a sorted fashion where the first element has the lowest compute time. The total number of resulting algorithms can be queried through the API [cudnnGetConvolutionBackwardFilterAlgorithmMaxCount\(\)](#).



Note: This function is host blocking.

Parameters

handle

Input. Handle to a previously created cuDNN context.

xDesc

Input. Handle to the previously initialized input tensor descriptor.

x

Input. Data pointer to GPU memory associated with the filter descriptor `xDesc`.

dyDesc

Input. Handle to the previously initialized input differential tensor descriptor.

dy

Input. Data pointer to GPU memory associated with the tensor descriptor `dyDesc`.

convDesc

Input. Previously initialized convolution descriptor.

dwDesc

Input. Handle to a previously initialized filter descriptor.

dw

Input/Output. Data pointer to GPU memory associated with the filter descriptor `dwDesc`. The content of this tensor will be overwritten with arbitrary values.

requestedAlgoCount

Input. The maximum number of elements to be stored in `perfResults`.

returnedAlgoCount

Output. The number of output elements stored in `perfResults`.

perfResults

Output. A user-allocated array to store performance metrics sorted ascending by compute time.

workSpace

Input. Data pointer to GPU memory is a necessary workspace for some algorithms. The size of this workspace will determine the availability of algorithms. A nil pointer is considered a `workSpace` of 0 bytes.

workSpaceSizeInBytes

Input. Specifies the size in bytes of the provided `workSpace`.

Returns**CUDNN_STATUS_SUCCESS**

The query was successful.

CUDNN_STATUS_BAD_PARAM

At least one of the following conditions are met:

- ▶ `handle` is not allocated properly.
- ▶ `xDesc`, `dyDesc`, or `dwDesc` are not allocated properly.
- ▶ `xDesc`, `dyDesc`, or `dwDesc` has fewer than 1 dimension.
- ▶ `x`, `dy`, or `dw` is nil.
- ▶ Either `returnedCount` or `perfResults` is nil.
- ▶ `requestedCount` is less than 1.

CUDNN_STATUS_INTERNAL_ERROR

At least one of the following conditions are met:

- ▶ The function was unable to allocate necessary timing objects.
- ▶ The function was unable to deallocate necessary timing objects.
- ▶ The function was unable to deallocate sample input, filters and output.

6.2.11. cudnnFusedOpsExecute ()

```
cudnnStatus_t cudnnFusedOpsExecute (
    cudnnHandle_t handle,
    const cudnnFusedOpsPlan_t plan,
    cudnnFusedOpsVariantParamPack_t varPack);
```

This function executes the sequence of `cudnnFusedOps` operations.

Parameters

handle

Input. Pointer to the cuDNN library context.

plan

Input. Pointer to a previously-created and initialized plan descriptor.

varPack

Input. Pointer to the descriptor to the variant parameters pack.

Returns

CUDNN_STATUS_BAD_PARAM

If the type of `cudaFusedOps_t` in the plan descriptor is unsupported.

6.2.12. `cudaGetConvolutionBackwardFilterAlgorithmMaxCount`

```
cudaStatus_t cudaGetConvolutionBackwardFilterAlgorithmMaxCount(
    cudaHandle_t      handle,
    int               *count)
```

This function returns the maximum number of algorithms which can be returned from `cudaFindConvolutionBackwardFilterAlgorithm()` and `cudaGetConvolutionForwardAlgorithm_v7()`. This is the sum of all algorithms plus the sum of all algorithms with Tensor Core operations supported for the current device.

Parameters

handle

Input. Handle to a previously created cuDNN context.

count

Output. The resulting maximum count of algorithms.

Returns

CUDNN_STATUS_SUCCESS

The function was successful.

CUDNN_STATUS_BAD_PARAM

The provided handle is not allocated properly.

6.2.13. `cudaGetConvolutionBackwardFilterAlgorithm_v7`

```
cudaStatus_t cudaGetConvolutionBackwardFilterAlgorithm_v7(
    cudaHandle_t      handle,
    const cudaTensorDescriptor_t  xDesc,
    const cudaTensorDescriptor_t  dyDesc,
    const cudaConvolutionDescriptor_t  convDesc,
    const cudaFilterDescriptor_t  dwDesc,
    const int         requestedAlgoCount,
```

```
int cudnnConvolutionBwdFilterAlgoPerf_t (*returnedAlgoCount,
                                         *perfResults)
```

This function serves as a heuristic for obtaining the best suited algorithm for [cudnnConvolutionBackwardFilter\(\)](#) for the given layer specifications. This function will return all algorithms (including CUDNN_TENSOR_OP_MATH and CUDNN_DEFAULT_MATH versions of algorithms where CUDNN_TENSOR_OP_MATH may be available) sorted by expected (based on internal heuristic) relative performance with fastest being index 0 of `perfResults`. For an exhaustive search for the fastest algorithm, use [cudnnFindConvolutionBackwardFilterAlgorithm\(\)](#). The total number of resulting algorithms can be queried through the `returnedAlgoCount` variable.

Parameters

handle

Input. Handle to a previously created cuDNN context.

xDesc

Input. Handle to the previously initialized input tensor descriptor.

dyDesc

Input. Handle to the previously initialized input differential tensor descriptor.

convDesc

Input. Previously initialized convolution descriptor.

dwDesc

Input. Handle to a previously initialized filter descriptor.

requestedAlgoCount

Input. The maximum number of elements to be stored in `perfResults`.

returnedAlgoCount

Output. The number of output elements stored in `perfResults`.

perfResults

Output. A user-allocated array to store performance metrics sorted ascending by compute time.

Returns

CUDNN_STATUS_SUCCESS

The query was successful.

CUDNN_STATUS_BAD_PARAM

At least one of the following conditions are met:

- ▶ One of the parameters `handle`, `xDesc`, `dyDesc`, `convDesc`, `dwDesc`, `perfResults`, `returnedAlgoCount` is NULL.

- ▶ The numbers of feature maps of the input tensor and output tensor differ.
- ▶ The dataType of the two tensor descriptors or the filter are different.
- ▶ requestedAlgoCount is less than or equal to 0.

6.2.14. cudnnGetConvolutionBackwardFilterWorkspaceSize

```

cudnnStatus_t cudnnGetConvolutionBackwardFilterWorkspaceSize(
    cudnnHandle_t          handle,
    const cudnnTensorDescriptor_t xDesc,
    const cudnnTensorDescriptor_t dyDesc,
    const cudnnConvolutionDescriptor_t convDesc,
    const cudnnFilterDescriptor_t dwDesc,
    cudnnConvolutionBwdFilterAlgo_t algo,
    size_t                 *sizeInBytes)
    
```

This function returns the amount of GPU memory workspace the user needs to allocate to be able to call [cudnnConvolutionBackwardFilter\(\)](#) with the specified algorithm. The workspace allocated will then be passed to the routine [cudnnConvolutionBackwardFilter\(\)](#). The specified algorithm can be the result of the call to [cudnnGetConvolutionBackwardFilterAlgorithm_v7\(\)](#) or can be chosen arbitrarily by the user. Note that not every algorithm is available for every configuration of the input tensor and/or every configuration of the convolution descriptor.

Parameters

handle

Input. Handle to a previously created cuDNN context.

xDesc

Input. Handle to the previously initialized input tensor descriptor.

dyDesc

Input. Handle to the previously initialized input differential tensor descriptor.

convDesc

Input. Previously initialized convolution descriptor.

dwDesc

Input. Handle to a previously initialized filter descriptor.

algo

Input. Enumerant that specifies the chosen convolution algorithm.

sizeInBytes

Output. Amount of GPU memory needed as workspace to be able to execute a forward convolution with the specified algo.

Returns

CUDNN_STATUS_SUCCESS

The query was successful.

CUDNN_STATUS_BAD_PARAM

At least one of the following conditions are met:

- ▶ The numbers of feature maps of the input tensor and output tensor differ.
- ▶ The `dataType` of the two tensor descriptors or the filter are different.

CUDNN_STATUS_NOT_SUPPORTED

The combination of the tensor descriptors, filter descriptor and convolution descriptor is not supported for the specified algorithm.

6.2.15. `cudaGetFusedOpsConstParamPackAttribute()`

```

cudaStatus_t cudaGetFusedOpsConstParamPackAttribute(
    const cudaFusedOpsConstParamPack_t constPack,
    cudaFusedOpsConstParamLabel_t paramLabel,
    void *param,
    int *isNULL);

```

This function retrieves the values of the descriptor pointed to by the `param` pointer input. The type of the descriptor is indicated by the enum value of `paramLabel` input.

Parameters

constPack

Input. The opaque `cudaFusedOpsConstParamPack_t` structure that contains the various problem size information, such as the shape, layout and the type of tensors, and the descriptors for convolution and activation, for the selected sequence of `cudaFusedOps_t` computations.

paramLabel

Input. Several types of descriptors can be retrieved by this getter function. The `param` input points to the descriptor itself, and this input indicates the type of the descriptor pointed to by the `param` input. The `cudaFusedOpsConstParamLabel_t` enumerant type enables the selection of the type of the descriptor. Refer to the `param` description below.

param

Input. Data pointer to the host memory associated with the descriptor that should be retrieved. The type of this descriptor depends on the value of `paramLabel`. For the given `paramLabel`, if the associated value inside the `constPack` is set to `NULL` or by default `NULL`, then cuDNN will copy the value or the opaque structure in the `constPack` to the host memory buffer pointed to by `param`. For more information, see the table in `cudaFusedOpsConstParamLabel_t`.

isNULL

Input/Output. Users must pass a pointer to an integer in the host memory in this field. If the value in the `constPack` associated with the given `paramLabel` is by default `NULL` or previously set by the user to `NULL`, then cuDNN will write a non-zero value to the location pointed by `isNULL`.

Returns

CUDNN_STATUS_SUCCESS

The descriptor values are retrieved successfully.

CUDNN_STATUS_BAD_PARAM

If either `constPack`, `param` or `isNULL` is NULL; or if `paramLabel` is invalid.

6.2.16. cudnnGetFusedOpsVariantParamPackAttribute()

```

cudnnStatus_t cudnnGetFusedOpsVariantParamPackAttribute(
    const cudnnFusedOpsVariantParamPack_t varPack,
    cudnnFusedOpsVariantParamLabel_t paramLabel,
    void *ptr);

```

This function retrieves the settings of the variable parameter pack descriptor.

Parameters

varPack

Input. Pointer to the `cudnnFusedOps` variant parameter pack (`varPack`) descriptor.

paramLabel

Input. Type of the buffer pointer parameter (in the `varPack` descriptor). For more information, see [cudnnFusedOpsConstParamLabel_t](#). The retrieved descriptor values vary according to this type.

ptr

Output. Pointer to the host or device memory where the retrieved value is written by this function. The data type of the pointer, and the host/device memory location, depend on the `paramLabel` input selection. For more information, see [cudnnFusedOpsVariantParamLabel_t](#).

Returns

CUDNN_STATUS_SUCCESS

The descriptor values are retrieved successfully.

CUDNN_STATUS_BAD_PARAM

If either `varPack` or `ptr` is NULL, or if `paramLabel` is set to invalid value.

6.2.17. cudnnMakeFusedOpsPlan()

```

cudnnStatus_t cudnnMakeFusedOpsPlan(
    cudnnHandle_t handle,
    cudnnFusedOpsPlan_t plan,
    const cudnnFusedOpsConstParamPack_t constPack,
    size_t *workspaceSizeInBytes);

```

This function determines the optimum kernel to execute, and the workspace size the user should allocate, prior to the actual execution of the fused operations by [cudnnFusedOpsExecute\(\)](#).

Parameters

handle

Input. Pointer to the cuDNN library context.

plan

Input. Pointer to a previously-created and initialized plan descriptor.

constPack

Input. Pointer to the descriptor to the const parameters pack.

workspaceSizeInBytes

Output. The amount of workspace size the user should allocate for the execution of this plan.

Returns

CUDNN_STATUS_BAD_PARAM

If any of the inputs is `NULL`, or if the type of `cudnnFusedOps_t` in the `constPack` descriptor is unsupported.

CUDNN_STATUS_SUCCESS

The function executed successfully.

6.2.18. `cudnnSetFusedOpsConstParamPackAttribute()`

```
cudnnStatus_t cudnnSetFusedOpsConstParamPackAttribute(
    cudnnFusedOpsConstParamPack_t constPack,
    cudnnFusedOpsConstParamLabel_t paramLabel,
    const void *param);
```

This function sets the descriptor pointed to by the `param` pointer input. The type of the descriptor to be set is indicated by the enum value of the `paramLabel` input.

Parameters

constPack

Input. The opaque `cudnnFusedOpsConstParamPack_t` structure that contains the various problem size information, such as the shape, layout and the type of tensors, the descriptors for convolution and activation, and settings for operations such as convolution and activation.

paramLabel

Input. Several types of descriptors can be set by this setter function. The `param` input points to the descriptor itself, and this input indicates the type of the descriptor pointed to by the `param` input. The `cudnnFusedOpsConstParamLabel_t` enumerant type enables the selection of the type of the descriptor.

param

Input. Data pointer to the host memory, associated with the specific descriptor. The type of the descriptor depends on the value of `paramLabel`. For more information, see the table in `cudnnFusedOpsConstParamLabel_t`.

If this pointer is set to `NULL`, then the cuDNN library will record as such. If not, then the values pointed to by this pointer (meaning, the value or the opaque structure underneath) will be copied into the `constPack` during `cudaSetFusedOpsConstParamPackAttribute()` operation.

Returns

CUDNN_STATUS_SUCCESS

The descriptor is set successfully.

CUDNN_STATUS_BAD_PARAM

If `constPack` is `NULL`, or if `paramLabel` or the ops setting for `constPack` is invalid.

6.2.19. `cudaSetFusedOpsVariantParamPackAttribute()`

```
cudaStatus_t cudaSetFusedOpsVariantParamPackAttribute(
    cudaFusedOpsVariantParamPack_t varPack,
    cudaFusedOpsVariantParamLabel_t paramLabel,
    void *ptr);
```

This function sets the variable parameter pack descriptor.

Parameters

varPack

Input. Pointer to the `cudaFusedOps` variant parameter pack (`varPack`) descriptor.

paramLabel

Input. Type to which the buffer pointer parameter (in the `varPack` descriptor) is set by this function. For more information, see [cudaFusedOpsConstParamLabel_t](#).

ptr

Input. Pointer, to the host or device memory, to the value to which the descriptor parameter is set. The data type of the pointer, and the host/device memory location, depend on the `paramLabel` input selection. For more information, see [cudaFusedOpsVariantParamLabel_t](#).

Returns

CUDNN_STATUS_BAD_PARAM

If `varPack` is `NULL` or if `paramLabel` is set to an unsupported value.

CUDNN_STATUS_SUCCESS

The descriptor was set successfully.

Chapter 7. `cudaAdvInfer.so` Library

7.1. Data Type References

7.1.1. Pointer To Opaque Struct Types

7.1.1.1. `cudaAttnDescriptor_t`

`cudaAttnDescriptor_t` is a pointer to an opaque structure holding parameters of the multi-head attention layer such as:

- ▶ weight and bias tensor shapes (vector lengths before and after linear projections)
- ▶ parameters that can be set in advance and do not change when invoking functions to evaluate forward responses and gradients (number of attention heads, softmax smoothing/sharpening coefficient)
- ▶ other settings that are necessary to compute temporary buffer sizes.

Use the [`cudaCreateAttnDescriptor\(\)`](#) function to create an instance of the attention descriptor object and [`cudaDestroyAttnDescriptor\(\)`](#) to delete the previously created descriptor. Use the [`cudaSetAttnDescriptor\(\)`](#) function to configure the descriptor.

7.1.1.2. `cudaPersistentRNNPlan_t`

This function is deprecated starting in cuDNN 8.0.0.

`cudaPersistentRNNPlan_t` is a pointer to an opaque structure holding a plan to execute a dynamic persistent RNN. [`cudaCreatePersistentRNNPlan\(\)`](#) is used to create and initialize one instance.

7.1.1.3. `cudaRNNDataDescriptor_t`

`cudaRNNDataDescriptor_t` is a pointer to an opaque structure holding the description of an RNN data set. The function [`cudaCreateRNNDataDescriptor\(\)`](#) is used to create one instance, and [`cudaSetRNNDataDescriptor\(\)`](#) must be used to initialize this instance.

7.1.1.4. `cudaRNNDescriptor_t`

`cudaRNNDescriptor_t` is a pointer to an opaque structure holding the description of an RNN operation. [cudaCreateRNNDescriptor\(\)](#) is used to create one instance.

7.1.1.5. `cudaSeqDataDescriptor_t`

`cudaSeqDataDescriptor_t` is a pointer to an opaque structure holding parameters of the sequence data container or buffer. The sequence data container is used to store fixed size vectors defined by the `VECT` dimension. Vectors are arranged in additional three dimensions: `TIME`, `BATCH` and `BEAM`.

The `TIME` dimension is used to bundle vectors into sequences of vectors. The actual sequences can be shorter than the `TIME` dimension, therefore, additional information is needed about each sequence length and how unused (padding) vectors should be saved.

It is assumed that the sequence data container is fully packed. The `TIME`, `BATCH` and `BEAM` dimensions can be in any order when vectors are traversed in the ascending order of addresses. Six data layouts (permutation of `TIME`, `BATCH` and `BEAM`) are possible.

The `cudaSeqDataDescriptor_t` object holds the following parameters:

- ▶ data type used by vectors
- ▶ `TIME`, `BATCH`, `BEAM` and `VECT` dimensions
- ▶ data layout
- ▶ the length of each sequence along the `TIME` dimension
- ▶ an optional value to be copied to output padding vectors

Use the [cudaCreateSeqDataDescriptor\(\)](#) function to create one instance of the sequence data descriptor object and [cudaDestroySeqDataDescriptor\(\)](#) to delete a previously created descriptor. Use the [cudaSetSeqDataDescriptor\(\)](#) function to configure the descriptor.

This descriptor is used by multi-head attention API functions.

7.1.2. Enumeration Types

7.1.2.1. `cudaDirectionMode_t`

`cudaDirectionMode_t` is an enumerated type used to specify the recurrence pattern in the [cudaRNNForwardInference\(\)](#), [cudaRNNForwardTraining\(\)](#), [cudaRNNBackwardData\(\)](#) and [cudaRNNBackwardWeights\(\)](#) routines.

Values

CUDNN_UNIDIRECTIONAL

The network iterates recurrently from the first input to the last.

CUDNN_BIDIRECTIONAL

Each layer of the network iterates recurrently from the first input to the last and separately from the last input to the first. The outputs of the two are concatenated at each iteration giving the output of the layer.

7.1.2.2. cudnnForwardMode_t

`cudnnForwardMode_t` is an enumerated type to specify inference or training mode in RNN API. This parameter allows the cuDNN library to tune more precisely the size of the workspace buffer that could be different in inference and training regimens.

Values**CUDNN_FWD_MODE_INFERENCE**

Selects the inference mode.

CUDNN_FWD_MODE_TRAINING

Selects the training mode.

7.1.2.3. cudnnMultiHeadAttnWeightKind_t

`cudnnMultiHeadAttnWeightKind_t` is an enumerated type that specifies a group of weights or biases in the [cudnnGetMultiHeadAttnWeights\(\)](#) function.

Values**CUDNN_MH_ATTN_Q_WEIGHTS**

Selects the input projection weights for `queries`.

CUDNN_MH_ATTN_K_WEIGHTS

Selects the input projection weights for `keys`.

CUDNN_MH_ATTN_V_WEIGHTS

Selects the input projection weights for `values`.

CUDNN_MH_ATTN_O_WEIGHTS

Selects the output projection weights.

CUDNN_MH_ATTN_Q_BIASES

Selects the input projection biases for `queries`.

CUDNN_MH_ATTN_K_BIASES

Selects the input projection biases for `keys`.

CUDNN_MH_ATTN_V_BIASES

Selects the input projection biases for `values`.

CUDNN_MH_ATTN_O_BIASES

Selects the output projection biases.

7.1.2.4. `cudnnRNNBiasMode_t`

`cudnnRNNBiasMode_t` is an enumerated type used to specify the number of bias vectors for RNN functions. See the description of the `cudnnRNNMode_t` enumerated type for the equations for each cell type based on the bias mode.

Values

CUDNN_RNN_NO_BIAS

Applies RNN cell formulas that do not use biases.

CUDNN_RNN_SINGLE_INP_BIAS

Applies RNN cell formulas that use one input bias vector in the input GEMM.

CUDNN_RNN_DOUBLE_BIAS

Applies RNN cell formulas that use two bias vectors.

CUDNN_RNN_SINGLE_REC_BIAS

Applies RNN cell formulas that use one recurrent bias vector in the recurrent GEMM.

7.1.2.5. `cudnnRNNClipMode_t`

`cudnnRNNClipMode_t` is an enumerated type used to select the LSTM cell clipping mode. It is used with `cudnnRNNSetClip()`, `cudnnRNNGetClip()` functions, and internally within LSTM cells.

Values

CUDNN_RNN_CLIP_NONE

Disables LSTM cell clipping.

CUDNN_RNN_CLIP_MINMAX

Enables LSTM cell clipping.

7.1.2.6. `cudnnRNNDataLayout_t`

`cudnnRNNDataLayout_t` is an enumerated type used to select the RNN data layout. It is used in the API calls `cudnnGetRNNDataDescriptor()` and `cudnnSetRNNDataDescriptor()`.

Values

CUDNN_RNN_DATA_LAYOUT_SEQ_MAJOR_UNPACKED

Data layout is padded, with outer stride from one time-step to the next.

CUDNN_RNN_DATA_LAYOUT_SEQ_MAJOR_PACKED

The sequence length is sorted and packed as in the basic RNN API.

CUDNN_RNN_DATA_LAYOUT_BATCH_MAJOR_UNPACKED

Data layout is padded, with outer stride from one batch to the next.

7.1.2.7. cudnnRNNInputMode_t

cudnnRNNInputMode_t is an enumerated type used to specify the behavior of the first layer in the [cudnnRNNForwardInference\(\)](#), [cudnnRNNForwardTraining\(\)](#), [cudnnRNNBackwardData\(\)](#) and [cudnnRNNBackwardWeights\(\)](#) routines.

Values

CUDNN_LINEAR_INPUT

A biased matrix multiplication is performed at the input of the first recurrent layer.

CUDNN_SKIP_INPUT

No operation is performed at the input of the first recurrent layer. If CUDNN_SKIP_INPUT is used the leading dimension of the input tensor must be equal to the hidden state size of the network.

7.1.2.8. cudnnRNNMode_t

cudnnRNNMode_t is an enumerated type used to specify the type of network used in the [cudnnRNNForwardInference](#), [cudnnRNNForwardTraining](#), [cudnnRNNBackwardData](#) and [cudnnRNNBackwardWeights](#) routines.

Values

CUDNN_RNN_RELU

A single-gate recurrent neural network with a ReLU activation function.

In the forward pass, the output h_t for a given iteration can be computed from the recurrent input h_{t-1} and the previous layer input x_t , given the matrices w , r and the bias vectors, where $\text{ReLU}(x) = \max(x, 0)$.

If `cudnnRNNBiasMode_t biasMode` in `rnnDesc` is `CUDNN_RNN_DOUBLE_BIAS` (default mode), then the following equation with biases b_W and b_R applies:

$$h_t = \text{ReLU}(W_i x_t + R_i h_{t-1} + b_{Wi} + b_{Ri})$$

If `cudnnRNNBiasMode_t biasMode` in `rnnDesc` is `CUDNN_RNN_SINGLE_INP_BIAS` or `CUDNN_RNN_SINGLE_REC_BIAS`, then the following equation with bias b applies:

$$h_t = \text{ReLU}(W_i x_t + R_i h_{t-1} + b_i)$$

If `cudnnRNNBiasMode_t biasMode` in `rnnDesc` is `CUDNN_RNN_NO_BIAS`, then the following equation applies:

$$h_t = \text{ReLU}(W_i x_t + R_i h_{t-1})$$

CUDNN_RNN_TANH

A single-gate recurrent neural network with a tanh activation function.

In the forward pass, the output h_t for a given iteration can be computed from the recurrent input h_{t-1} and the previous layer input x_t , given the matrices w, R and the bias vectors, and where \tanh is the hyperbolic tangent function.

If `cudaRNNBiasMode_t biasMode` in `rnnDesc` is `CUDNN_RNN_DOUBLE_BIAS` (default mode), then the following equation with biases b_W and b_R applies:

$$h_t = \tanh(W_i x_t + R_i h_{t-1} + b_{Wi} + b_{Ri})$$

If `cudaRNNBiasMode_t biasMode` in `rnnDesc` is `CUDNN_RNN_SINGLE_INP_BIAS` or `CUDNN_RNN_SINGLE_REC_BIAS`, then the following equation with bias b applies:

$$h_t = \tanh(W_i x_t + R_i h_{t-1} + b_i)$$

If `cudaRNNBiasMode_t biasMode` in `rnnDesc` is `CUDNN_RNN_NO_BIAS`, then the following equation applies:

$$h_t = \tanh(W_i x_t + R_i h_{t-1})$$

CUDNN_LSTM

A four-gate Long Short-Term Memory (LSTM) network with no peephole connections.

In the forward pass, the output h_t and cell output c_t for a given iteration can be computed from the recurrent input h_{t-1} , the cell input c_{t-1} and the previous layer input x_t , given the matrices w, R and the bias vectors.

In addition, the following applies:

- ▶ σ is the sigmoid operator such that: $\sigma(x) = 1 / (1 + e^{-x})$,
- ▶ \circ represents a point-wise multiplication,
- ▶ \tanh is the hyperbolic tangent function, and
- ▶ i_t, f_t, o_t, c'_t represent the input, forget, output and new gates respectively.

If `cudaRNNBiasMode_t biasMode` in `rnnDesc` is `CUDNN_RNN_DOUBLE_BIAS` (default mode), then the following equations with biases b_W and b_R apply:

$$i_t = \sigma(W_i x_t + R_i h_{t-1} + b_{Wi} + b_{Ri})$$

$$f_t = \sigma(W_f x_t + R_f h_{t-1} + b_{Wf} + b_{Rf})$$

$$o_t = \sigma(W_o x_t + R_o h_{t-1} + b_{Wo} + b_{Ro})$$

$$c'_t = \tanh(W_c x_t + R_c h_{t-1} + b_{Wc} + b_{Rc})$$

$$c_t = f_t \circ c_{t-1} + i_t \circ c'_t$$

$$h_t = o_t \circ \tanh(c_t)$$

If `cudaRNNBiasMode_t biasMode` in `rnnDesc` is `CUDNN_RNN_SINGLE_INP_BIAS` or `CUDNN_RNN_SINGLE_REC_BIAS`, then the following equations with bias b apply:

$$i_t = \sigma (W_i x_t + R_i h_{t-1} + b_i)$$

$$f_t = \sigma (W_f x_t + R_f h_{t-1} + b_f)$$

$$o_t = \sigma (W_o x_t + R_o h_{t-1} + b_o)$$

$$c'_t = \tanh (W_c x_t + R_c h_{t-1} + b_c)$$

$$c_t = f_t \circ c_{t-1} + i_t \circ c'_t$$

$$h_t = o_t \circ \tanh (c_t)$$

If `cudaRNNBiasMode_t biasMode` in `rnnDesc` is `CUDNN_RNN_NO_BIAS`, then the following equations apply:

$$i_t = \sigma (W_i x_t + R_i h_{t-1})$$

$$f_t = \sigma (W_f x_t + R_f h_{t-1})$$

$$o_t = \sigma (W_o x_t + R_o h_{t-1})$$

$$c'_t = \tanh (W_c x_t + R_c h_{t-1})$$

$$c_t = f_t \circ c_{t-1} + i_t \circ c'_t$$

$$h_t = o_t \circ \tanh (c_t)$$

CUDNN_GRU

A three-gate network consisting of Gated Recurrent Units.

In the forward pass, the output h_t for a given iteration can be computed from the recurrent input h_{t-1} and the previous layer input x_t given matrices W, R and the bias vectors.

In addition, the following applies:

- ▶ σ is the sigmoid operator such that: $\sigma(x) = 1 / (1 + e^{-x})$,
- ▶ \circ represents a point-wise multiplication,
- ▶ \tanh is the hyperbolic tangent function, and
- ▶ i_t, r_t, h'_t represent the input, reset, new gates respectively.

If `cudaRNNBiasMode_t biasMode` in `rnnDesc` is `CUDNN_RNN_DOUBLE_BIAS` (default mode), then the following equations with biases b_W and b_R apply:

$$i_t = \sigma (W_i x_t + R_i h_{t-1} + b_{Wi} + b_{Ri})$$

$$r_t = \sigma (W_r x_t + R_r h_{t-1} + b_{Wr} + b_{Rr})$$

$$h'_t = \tanh (W_h x_t + r_t \circ (R_h h_{t-1} + b_{Rh}) + b_{Wh})$$

$$h_t = (1 - i_t) \circ h'_t + i_t \circ h_{t-1}$$

If `cudaRNNBiasMode_t biasMode` in `rnnDesc` is `CUDNN_RNN_SINGLE_INP_BIAS`, then the following equations with bias b apply:

$$i_t = \sigma (W_i x_t + R_i h_{t-1} + b_i)$$

$$r_t = \sigma (W_r x_t + R_r h_{t-1} + b_r)$$

$$h'_t = \tanh (W_h x_t + r_t \circ (R_h h_{t-1}) + b_{Wh})$$

$$h_t = (1 - i_t) \circ h'_t + i_t \circ h_{t-1}$$

If `cudaRNNBiasMode_t biasMode` in `rnnDesc` is `CUDNN_RNN_SINGLE_REC_BIAS`, then the following equations with bias b apply:

$$i_t = \sigma (W_i x_t + R_i h_{t-1} + b_i)$$

$$r_t = \sigma (W_r x_t + R_r h_{t-1} + b_r)$$

$$h'_t = \tanh (W_h x_t + r_t \circ (R_h h_{t-1} + b_{Rh}))$$

$$h_t = (1 - i_t) \circ h'_t + i_t \circ h_{t-1}$$

If `cudaRNNBiasMode_t biasMode` in `rnnDesc` is `CUDNN_RNN_NO_BIAS`, then the following equations apply:

$$i_t = \sigma (W_i x_t + R_i h_{t-1})$$

$$r_t = \sigma (W_r x_t + R_r h_{t-1})$$

$$h'_t = \tanh (W_h x_t + r_t \circ (R_h h_{t-1}))$$

$$h_t = (1 - i_t) \circ h'_t + i_t \circ h_{t-1}$$

7.1.2.9. `cudaRNNPaddingMode_t`

`cudaRNNPaddingMode_t` is an enumerated type used to enable or disable the padded input/output.

Values

CUDNN_RNN_PADDED_IO_DISABLED

Disables the padded input/output.

CUDNN_RNN_PADDED_IO_ENABLED

Enables the padded input/output.

7.1.2.10. `cudaSeqDataAxis_t`

`cudaSeqDataAxis_t` is an enumerated type that indexes active dimensions in the `dimA[]` argument that is passed to the `cudaSetSeqDataDescriptor()` function to configure the sequence data descriptor of type `cudaSeqDataDescriptor_t`.

cudaSeqDataAxis_t constants are also used in the axis[] argument of the [cudaSetSeqDataDescriptor\(\)](#) call to define the layout of the sequence data buffer in memory.

See [cudaSetSeqDataDescriptor\(\)](#) for a detailed description on how to use the cudaSeqDataAxis_t enumerated type.

The CUDNN_SEQDATA_DIM_COUNT macro defines the number of constants in the cudaSeqDataAxis_t enumerated type. This value is currently set to 4.

Values

CUDNN_SEQDATA_TIME_DIM

Identifies the TIME (sequence length) dimension or specifies the TIME in the data layout.

CUDNN_SEQDATA_BATCH_DIM

Identifies the BATCH dimension or specifies the BATCH in the data layout.

CUDNN_SEQDATA_BEAM_DIM

Identifies the BEAM dimension or specifies the BEAM in the data layout.

CUDNN_SEQDATA_VECT_DIM

Identifies the VECT (vector) dimension or specifies the VECT in the data layout.

7.2. API Functions

7.2.1. cudaAdvInferVersionCheck ()

```
cudaStatus_t cudaAdvInferVersionCheck(void)
```

This function checks to see whether the version of the AdvInfer subset of the library is consistent with the other sub-libraries.

Returns

CUDNN_STATUS_SUCCESS

The version is consistent with other sub-libraries.

CUDNN_STATUS_VERSION_MISMATCH

The version of AdvInfer is not consistent with other sub-libraries. Users should check the installation and make sure all sub-component versions are consistent.

7.2.2. cudaBuildRNNDynamic ()

```
cudaStatus_t cudaBuildRNNDynamic(
    cudaHandle_t handle,
    cudaRNNDesc_t rnnDesc,
    int32_t miniBatch);
```

This function compiles the RNN persistent code using CUDA runtime compilation library (NVRTC) when the `CUDNN_RNN_ALGO_PERSIST_DYNAMIC` algo is selected. The code is tailored to the current GPU and specific hyperparameters (`miniBatch`). This call is expected to be expensive in terms of runtime and should be invoked infrequently. Note that the `CUDNN_RNN_ALGO_PERSIST_DYNAMIC` algo does not support variable length sequences within the batch.

Parameters

handle

Input. Handle to a previously created cuDNN context.

rnnDesc

Input. A previously initialized RNN descriptor.

miniBatch

Input. The exact number of sequences in a batch.

Returns

CUDNN_STATUS_SUCCESS

The code was built and linked successfully.

CUDNN_STATUS_MAPPING_ERROR

A GPU/CUDA resource, such as a texture object, shared memory, or zero-copy memory is not available in the required size or there is a mismatch between the user resource and cuDNN internal resources. A resource mismatch may occur, for example, when calling `cudaSetStream()`. There could be a mismatch between the user provided CUDA stream and the internal CUDA events instantiated in the cuDNN handle when `cudaCreate()` was invoked.

This error status may not be correctable when it is related to texture dimensions, shared memory size, or zero-copy memory availability. If `CUDNN_STATUS_MAPPING_ERROR` is returned by `cudaSetStream()`, then it is typically correctable, however, it means that the cuDNN handle was created on one GPU and the user stream passed to this function is associated with another GPU.

CUDNN_STATUS_ALLOC_FAILED

The resources could not be allocated.

CUDNN_STATUS_RUNTIME_PREREQUISITE_MISSING

The prerequisite runtime library could not be found.

CUDNN_STATUS_NOT_SUPPORTED

The current hyper-parameters are invalid.

7.2.3. `cudaCreateAttnDescriptor()`

```
cudaStatus_t cudaCreateAttnDescriptor(cudaAttnDescriptor_t *attnDesc);
```

This function creates one instance of an opaque attention descriptor object by allocating the host memory for it and initializing all descriptor fields. The function writes NULL to `attnDesc` when the attention descriptor object cannot be allocated.

Use the [cudaSetAttnDescriptor\(\)](#) function to configure the attention descriptor and [cudaDestroyAttnDescriptor\(\)](#) to destroy it and release the allocated memory.

Parameters

attnDesc

Output. Pointer where the address to the newly created attention descriptor should be written.

Returns

CUDNN_STATUS_SUCCESS

The descriptor object was created successfully.

CUDNN_STATUS_BAD_PARAM

An invalid input argument was encountered (`attnDesc=NULL`).

CUDNN_STATUS_ALLOC_FAILED

The memory allocation failed.

7.2.4. `cudaCreatePersistentRNNPlan()`

This function has been deprecated in cuDNN 8.0. Use [cudaBuildRNNDynamic\(\)](#) instead of `cudaCreatePersistentRNNPlan()`.

```
cudaStatus_t cudaCreatePersistentRNNPlan(
    cudaRNNDesc_t          rnnDesc,
    const int              minibatch,
    const cudaDataType_t   dataType,
    cudaPersistentRNNPlan_t *plan)
```

This function creates a plan to execute persistent RNNs when using the `CUDNN_RNN_ALGO_PERSIST_DYNAMIC` algo. This plan is tailored to the current GPU and problem hyperparameters. This function call is expected to be expensive in terms of runtime and should be used infrequently. For more information, see [cudaRNNDesc_t](#), [cudaDataType_t](#), and [cudaPersistentRNNPlan_t](#).

Returns

CUDNN_STATUS_SUCCESS

The object was created successfully.

CUDNN_STATUS_MAPPING_ERROR

A GPU/CUDA resource, such as a texture object, shared memory, or zero-copy memory is not available in the required size or there is a mismatch between the user resource and cuDNN internal resources. A resource mismatch may occur, for example, when calling `cudaSetStream()`. There could be a mismatch between the user provided CUDA stream and the internal CUDA events instantiated in the cuDNN handle when `cudaCreate()` was invoked.

This error status may not be correctable when it is related to texture dimensions, shared memory size, or zero-copy memory availability. If `CUDNN_STATUS_MAPPING_ERROR` is returned by `cudaSetStream()`, then it is typically correctable, however, it means that the cuDNN handle was created on one GPU and the user stream passed to this function is associated with another GPU.

CUDNN_STATUS_ALLOC_FAILED

The resources could not be allocated.

CUDNN_STATUS_RUNTIME_PREREQUISITE_MISSING

A prerequisite runtime library cannot be found.

CUDNN_STATUS_NOT_SUPPORTED

The current hyperparameters are invalid.

7.2.5. `cudaCreateRNNDataDescriptor()`

```
cudaStatus_t cudaCreateRNNDataDescriptor(
    cudaRNNDataDescriptor_t *RNNDataDesc)
```

This function creates a RNN data descriptor object by allocating the memory needed to hold its opaque structure.

Returns

CUDNN_STATUS_SUCCESS

The RNN data descriptor object was created successfully.

CUDNN_STATUS_BAD_PARAM

`RNNDataDesc` is NULL.

CUDNN_STATUS_ALLOC_FAILED

The resources could not be allocated.

7.2.6. `cudaCreateRNNDescriptor()`

```
cudaStatus_t cudaCreateRNNDescriptor(
    cudaRNNDescriptor_t *rnnDesc)
```

This function creates a generic RNN descriptor object by allocating the memory needed to hold its opaque structure.

Returns

CUDNN_STATUS_SUCCESS

The object was created successfully.

CUDNN_STATUS_ALLOC_FAILED

The resources could not be allocated.

7.2.7. **cudaCreateSeqDataDescriptor()**

```
cudaStatus_t cudaCreateSeqDataDescriptor(cudaSeqDataDescriptor_t *seqDataDesc);
```

This function creates one instance of an opaque sequence data descriptor object by allocating the host memory for it and initializing all descriptor fields. The function writes `NULL` to `seqDataDesc` when the sequence data descriptor object cannot be allocated.

Use the [cudaSetSeqDataDescriptor\(\)](#) function to configure the sequence data descriptor and [cudaDestroySeqDataDescriptor\(\)](#) to destroy it and release the allocated memory.

Parameters

seqDataDesc

Output. Pointer where the address to the newly created sequence data descriptor should be written.

Returns

CUDNN_STATUS_SUCCESS

The descriptor object was created successfully.

CUDNN_STATUS_BAD_PARAM

An invalid input argument was encountered (`seqDataDesc=NULL`).

CUDNN_STATUS_ALLOC_FAILED

The memory allocation failed.

7.2.8. **cudaDestroyAttnDescriptor()**

```
cudaStatus_t cudaDestroyAttnDescriptor(cudaAttnDescriptor_t attnDesc);
```

This function destroys the attention descriptor object and releases its memory. The `attnDesc` argument can be `NULL`. Invoking `cudaDestroyAttnDescriptor()` with a `NULL` argument is a no operation (NOP).

The `cudaDestroyAttnDescriptor()` function is not able to detect if the `attnDesc` argument holds a valid address. Undefined behavior will occur in case of passing an invalid pointer, not returned by the [cudaCreateAttnDescriptor\(\)](#) function, or in the double deletion scenario of a valid address.

Parameters

attnDesc

Input. Pointer to the attention descriptor object to be destroyed.

Returns

CUDNN_STATUS_SUCCESS

The descriptor was destroyed successfully.

7.2.9. cudnnDestroyPersistentRNNPlan()

This function has been deprecated in cuDNN 8.0.

```
cudaStatus_t cudnnDestroyPersistentRNNPlan(
    cudaPersistentRNNPlan_t plan)
```

This function destroys a previously created persistent RNN plan object.

Returns

CUDNN_STATUS_SUCCESS

The object was destroyed successfully.

7.2.10. cudnnDestroyRNNDataDescriptor()

```
cudaStatus_t cudnnDestroyRNNDataDescriptor(
    cudaRNNDataDescriptor_t RNNDataDesc)
```

This function destroys a previously created RNN data descriptor object.

Returns

CUDNN_STATUS_SUCCESS

The RNN data descriptor object was destroyed successfully.

7.2.11. cudnnDestroyRNNDescriptor()

```
cudaStatus_t cudnnDestroyRNNDescriptor(
    cudaRNNDescriptor_t rnnDesc)
```

This function destroys a previously created RNN descriptor object.

Returns

CUDNN_STATUS_SUCCESS

The object was destroyed successfully.

7.2.12. cudnnDestroySeqDataDescriptor()

```
cudaStatus_t cudnnDestroySeqDataDescriptor(cudaSeqDataDescriptor_t seqDataDesc);
```

This function destroys the sequence data descriptor object and releases its memory. The seqDataDesc argument can be NULL. Invoking cudnnDestroySeqDataDescriptor() with a NULL argument is a no operation (NOP).

The cudnnDestroySeqDataDescriptor() function is not able to detect if the seqDataDesc argument holds a valid address. Undefined behavior will occur in case of passing an invalid pointer, not returned by the [cudnnCreateSeqDataDescriptor\(\)](#) function, or in the double deletion scenario of a valid address.

Parameters

seqDataDesc

Input. Pointer to the sequence data descriptor object to be destroyed.

Returns

CUDNN_STATUS_SUCCESS

The descriptor was destroyed successfully.

7.2.13. cudnnFindRNNForwardInferenceAlgorithmEx()

This function has been deprecated in cuDNN 8.0.

```
cudaStatus_t cudnnFindRNNForwardInferenceAlgorithmEx(
    cudaHandle_t          handle,
    const cudaRNNDescriptor_t  rnnDesc,
    const int             seqLength,
    const cudaTensorDescriptor_t *xDesc,
    const void            *x,
    const cudaTensorDescriptor_t hxDesc,
    const void            *hx,
    const cudaTensorDescriptor_t cxDesc,
    const void            *cx,
    const cudaFilterDescriptor_t wDesc,
    const void            *w,
    const cudaTensorDescriptor_t yDesc,
    void                 *y,
    const cudaTensorDescriptor_t hyDesc,
    void                 *hy,
    const cudaTensorDescriptor_t cyDesc,
    void                 *cy,
    const float           findIntensity,
    const int             requestedAlgoCount,
    int                   *returnedAlgoCount,
    cudaAlgorithmPerformance_t *perfResults,
    void                 *workspace,
    size_t                workspaceSizeInBytes)
```

This function attempts all available cuDNN algorithms for [cudnnRNNForwardInference\(\)](#), using user-allocated GPU memory. It outputs the parameters that influence the performance of the algorithm to a user-allocated array of cudaAlgorithmPerformance_t. These parameter metrics are written in sorted fashion where the first element has the lowest compute time.

Parameters

handle

Input. Handle to a previously created cuDNN context.

rnnDesc

Input. A previously initialized RNN descriptor.

seqLength

Input. Number of iterations to unroll over. The value of this `seqLength` must not exceed the value that was used in [cudnnGetRNNWorkspaceSize\(\)](#) function for querying the workspace size required to execute the RNN.

xDesc

Input. An array of fully packed tensor descriptors describing the input to each recurrent iteration (one descriptor per iteration). The first dimension (batch size) of the tensors may decrease from element n to element $n+1$ but may not increase. Each tensor descriptor must have the same second dimension (vector length).

x

Input. Data pointer to GPU memory associated with the tensor descriptors in the array `xDesc`. The data are expected to be packed contiguously with the first element of iteration $n+1$ following directly from the last element of iteration n .

hxDesc

Input. A fully packed tensor descriptor describing the initial hidden state of the RNN. The first dimension of the tensor depends on the `direction` argument used to initialize `rnnDesc`:

- ▶ If `direction` is `CUDNN_UNIDIRECTIONAL` the first dimension should match the `numLayers` argument.
- ▶ If `direction` is `CUDNN_BIDIRECTIONAL` the first dimension should match double the `numLayers` argument.

The second dimension must match the first dimension of the tensors described in `xDesc`. The third dimension must match the `hiddenSize` argument used to initialize `rnnDesc`. The tensor must be fully packed.

hx

Input. Data pointer to GPU memory associated with the tensor descriptor `hxDesc`. If a `NULL` pointer is passed, the initial hidden state of the network will be initialized to zero.

cxDesc

Input. A fully packed tensor descriptor describing the initial cell state for LSTM networks. The first dimension of the tensor depends on the `direction` argument used to initialize `rnnDesc`:

- ▶ If `direction` is `CUDNN_UNIDIRECTIONAL` the first dimension should match the `numLayers` argument.
- ▶ If `direction` is `CUDNN_BIDIRECTIONAL` the first dimension should match double the `numLayers` argument.

The second dimension must match the first dimension of the tensors described in `xDesc`. The third dimension must match the `hiddenSize` argument used to initialize `rnnDesc`. The tensor must be fully packed.

cx

Input. Data pointer to GPU memory associated with the tensor descriptor `cxDesc`. If a `NULL` pointer is passed, the initial cell state of the network will be initialized to zero.

wDesc

Input. Handle to a previously initialized filter descriptor describing the weights for the RNN.

w

Input. Data pointer to GPU memory associated with the filter descriptor `wDesc`.

yDesc

Input. An array of fully packed tensor descriptors describing the output from each recurrent iteration (one descriptor per iteration). The second dimension of the tensor depends on the `direction` argument used to initialize `rnnDesc`:

- ▶ If `direction` is `CUDNN_UNIDIRECTIONAL` the second dimension should match the `hiddenSize` argument.
- ▶ If `direction` is `CUDNN_BIDIRECTIONAL` the second dimension should match double the `hiddenSize` argument.

The first dimension of the tensor `n` must match the first dimension of the tensor `n` in `xDesc`.

y

Output. Data pointer to GPU memory associated with the output tensor descriptor `yDesc`. The data are expected to be packed contiguously with the first element of iteration `n+1` following directly from the last element of iteration `n`.

hyDesc

Input. A fully packed tensor descriptor describing the final hidden state of the RNN. The first dimension of the tensor depends on the `direction` argument used to initialize `rnnDesc`:

- ▶ If `direction` is `CUDNN_UNIDIRECTIONAL` the first dimension should match the `numLayers` argument.
- ▶ If `direction` is `CUDNN_BIDIRECTIONAL` the first dimension should match double the `numLayers` argument.

The second dimension must match the first dimension of the tensors described in `xDesc`. The third dimension must match the `hiddenSize` argument used to initialize `rnnDesc`. The tensor must be fully packed.

hy

Output. Data pointer to GPU memory associated with the tensor descriptor `hyDesc`. If a `NULL` pointer is passed, the final hidden state of the network will not be saved.

cyDesc

Input. A fully packed tensor descriptor describing the final cell state for LSTM networks. The first dimension of the tensor depends on the `direction` argument used to initialize `rnnDesc`:

- ▶ If `direction` is `CUDNN_UNIDIRECTIONAL` the first dimension should match the `numLayers` argument.
- ▶ If `direction` is `CUDNN_BIDIRECTIONAL` the first dimension should match double the `numLayers` argument.

The second dimension must match the first dimension of the tensors described in `xDesc`. The third dimension must match the `hiddenSize` argument used to initialize `rnnDesc`. The tensor must be fully packed.

cy

Output. Data pointer to GPU memory associated with the tensor descriptor `cyDesc`. If a `NULL` pointer is passed, the final cell state of the network will not be saved.

findIntensity

Input. This input was previously unused in versions prior to 7.2.0. It is used in cuDNN 7.2.0 and later versions to control the overall runtime of the RNN find algorithms, by selecting the percentage of a large Cartesian product space to be searched.

- ▶ Setting `findIntensity` within the range `[0,1.]` will set a percentage of the entire RNN search space to search. When `findIntensity` is set to `1.0`, a full search is performed over all RNN parameters.
- ▶ When `findIntensity` is set to `0.0f`, a quick, minimal search is performed. This setting has the best runtime. However, in this case the parameters returned by this function will not correspond to the best performance of the algorithm; a longer search might discover better parameters. This option will execute up to three instances of the configured RNN problem. Runtime will vary proportionally to RNN problem size, as it will in the other cases, hence no guarantee of an explicit time bound can be given.
- ▶ Setting `findIntensity` within the range `[-1.,0]` sets a percentage of a reduced Cartesian product space to be searched. This reduced search space has been heuristically selected to have good performance. The setting of `-1.0` represents a full search over this reduced search space.
- ▶ Values outside the range `[-1,1]` are truncated to the range `[-1,1]`, and then interpreted as per the above.

- ▶ Setting `findIntensity` to 1.0 in cuDNN 7.2 and later versions is equivalent to the behavior of this function in versions prior to cuDNN 7.2.0.
- ▶ This function times the single RNN executions over large parameter spaces - one execution per parameter combination. The times returned by this function are latencies.

requestedAlgoCount

Input. The maximum number of elements to be stored in `perfResults`.

returnedAlgoCount

Output. The number of output elements stored in `perfResults`.

perfResults

Output. A user-allocated array to store performance metrics sorted ascending by compute time.

workspace

Input. Data pointer to GPU memory to be used as a workspace for this call.

workspaceSizeInBytes

Input. Specifies the size in bytes of the provided `workspace`.

Returns**CUDNN_STATUS_SUCCESS**

The function launched successfully.

CUDNN_STATUS_NOT_SUPPORTED

The function does not support the provided configuration.

CUDNN_STATUS_BAD_PARAM

At least one of the following conditions are met:

- ▶ The descriptor `rnnDesc` is invalid.
- ▶ At least one of the descriptors `hxDesc`, `cxDesc`, `wDesc`, `hyDesc`, `cyDesc` or one of the descriptors in `xDesc`, `yDesc` is invalid.
- ▶ The descriptors in one of `xDesc`, `hxDesc`, `cxDesc`, `wDesc`, `yDesc`, `hyDesc`, `cyDesc` have incorrect strides or dimensions.
- ▶ `workspaceSizeInBytes` is too small.

CUDNN_STATUS_EXECUTION_FAILED

The function failed to launch on the GPU.

CUDNN_STATUS_ALLOC_FAILED

The function was unable to allocate memory.

7.2.14. cudnnGetAttnDescriptor()

```

cudnnStatus_t cudnnGetAttnDescriptor(
    cudnnAttnDescriptor_t attnDesc,
    unsigned *attnMode,
    int *nHeads,
    double *smScaler,
    cudnnDataType_t *dataType,
    cudnnDataType_t *computePrec,
    cudnnMathType_t *mathType,
    cudnnDropoutDescriptor_t *attnDropoutDesc,
    cudnnDropoutDescriptor_t *postDropoutDesc,
    int *qSize,
    int *kSize,
    int *vSize,
    int *qProjSize,
    int *kProjSize,
    int *vProjSize,
    int *oProjSize,
    int *qoMaxSeqLength,
    int *kvMaxSeqLength,
    int *maxBatchSize,
    int *maxBeamSize);

```

This function retrieves settings from the previously created attention descriptor. The user can assign NULL to any pointer except `attnDesc` when the retrieved value is not needed.

Parameters

attnDesc

Input. Attention descriptor.

attnMode

Output. Pointer to the storage for binary attention flags.

nHeads

Output. Pointer to the storage for the number of attention heads.

smScaler

Output. Pointer to the storage for the softmax smoothing/sharpening coefficient.

dataType

Output. Data type for attention weights, sequence data inputs, and outputs.

computePrec

Output. Pointer to the storage for the compute precision.

mathType

Output. NVIDIA Tensor Core settings.

attnDropoutDesc

Output. Descriptor of the dropout operation applied to the softmax output.

postDropoutDesc

Output. Descriptor of the dropout operation applied to the multi-head attention output.

qSize, kSize, vSize

Output. **Q**, **K**, and **V** embedding vector lengths.

qProjSize, kProjSize, vProjSize

Output. **Q**, **K**, and **V** embedding vector lengths after input projections.

oProjSize

Output. Pointer to store the output vector length after projection.

qoMaxSeqLength

Output. Largest sequence length expected in sequence data descriptors related to **Q, O, dQ, dO** inputs and outputs.

kvMaxSeqLength

Output. Largest sequence length expected in sequence data descriptors related to **K, V, dK, dV** inputs and outputs.

maxBatchSize

Output. Largest batch size expected in the [cudnnSeqDataDescriptor_t](#) container.

maxBeamSize

Output. Largest beam size expected in the [cudnnSeqDataDescriptor_t](#) container.

Returns

CUDNN_STATUS_SUCCESS

Requested attention descriptor fields were retrieved successfully.

CUDNN_STATUS_BAD_PARAM

An invalid input argument was found.

7.2.15. **cudnnGetMultiHeadAttnBuffers()**

```
cudnnStatus_t cudnnGetMultiHeadAttnBuffers(
    cudnnHandle_t handle,
    const cudnnAttnDescriptor_t attnDesc,
    size_t *weightSizeInBytes,
    size_t *workSpaceSizeInBytes,
    size_t *reserveSpaceSizeInBytes);
```

This function computes weight, work, and reserve space buffer sizes used by the following functions:

- ▶ [cudnnMultiHeadAttnForward\(\)](#)
- ▶ [cudnnMultiHeadAttnBackwardData\(\)](#)
- ▶ [cudnnMultiHeadAttnBackwardWeights\(\)](#)

Assigning NULL to the `reserveSpaceSizeInBytes` argument indicates that the user does not plan to invoke multi-head attention gradient functions: [cudnnMultiHeadAttnBackwardData\(\)](#) and [cudnnMultiHeadAttnBackwardWeights\(\)](#). This situation occurs in the inference mode.

Note: NULL cannot be assigned to `weightSizeInBytes` and `workSpaceSizeInBytes` pointers.

The user must allocate weight, work, and reserve space buffer sizes in the GPU memory using `cudaMalloc()` with the reported buffer sizes. The buffers can be also carved out from a larger chunk of allocated memory but the buffer addresses must be at least 16B aligned.

The work-space buffer is used for temporary storage. Its content can be discarded or modified after all GPU kernels launched by the corresponding API complete. The reserve-space buffer is used to transfer intermediate results from [cudnnMultiHeadAttnForward\(\)](#)

to [cudaMultiHeadAttnBackwardData\(\)](#), and from [cudaMultiHeadAttnBackwardData\(\)](#) to [cudaMultiHeadAttnBackwardWeights\(\)](#). The content of the reserve-space buffer cannot be modified until all GPU kernels launched by the above three multi-head attention API functions finish.

All multi-head attention weight and bias tensors are stored in a single weight buffer. For speed optimizations, the cuDNN API may change tensor layouts and their relative locations in the weight buffer based on the provided attention parameters. Use the [cudaGetMultiHeadAttnWeights\(\)](#) function to obtain the start address and the shape of each weight or bias tensor.

Parameters

handle

Input. The current cuDNN context handle.

attnDesc

Input. Pointer to a previously initialized attention descriptor.

weightSizeInBytes

Output. Minimum buffer size required to store all multi-head attention trainable parameters.

workSpaceSizeInBytes

Output. Minimum buffer size required to hold all temporary surfaces used by the forward and gradient multi-head attention API calls.

reserveSpaceSizeInBytes

Output. Minimum buffer size required to store all intermediate data exchanged between forward and backward (gradient) multi-head attention functions. Set this parameter to NULL in the inference mode indicating that gradient API calls will not be invoked.

Returns

CUDNN_STATUS_SUCCESS

The requested buffer sizes were computed successfully.

CUDNN_STATUS_BAD_PARAM

An invalid input argument was found.

7.2.16. [cudaGetMultiHeadAttnWeights\(\)](#)

```

cudaStatus_t cudaGetMultiHeadAttnWeights(
    cudaHandle_t handle,
    const cudaAttnDescriptor_t attnDesc,
    cudaMultiHeadAttnWeightKind_t wKind,
    size_t weightSizeInBytes,
    const void *weights,
    cudaTensorDescriptor_t wDesc,
    void **wAddr);

```

This function obtains the shape of the weight or bias tensor. It also retrieves the start address of tensor data located in the `weight` buffer. Use the `wKind` argument to select a particular tensor. For more information, see [`cudaMultiHeadAttnWeightKind_t`](#) for the description of the enumerant type.

Biases are used in the input and output projections when the `CUDNN_ATTN_ENABLE_PROJ_BIASES` flag is set in the attention descriptor. See [`cudaSetAttnDescriptor\(\)`](#) for the description of flags to control projection biases.

When the corresponding weight or bias tensor does not exist, the function writes `NULL` to the storage location pointed by `wAddr` and returns zeros in the `wDesc` tensor descriptor. The return status of the [`cudaGetMultiHeadAttnWeights\(\)`](#) function is `CUDNN_STATUS_SUCCESS` in this case.

The cuDNN `multiHeadAttention` sample code demonstrates how to access multi-head attention weights. Although the buffer with weights and biases should be allocated in the GPU memory, the user can copy it to the host memory and invoke the [`cudaGetMultiHeadAttnWeights\(\)`](#) function with the host weights address to obtain tensor pointers in the host memory. This scheme allows the user to inspect trainable parameters directly in the CPU memory.

Parameters

handle

Input. The current cuDNN context handle.

attnDesc

Input. A previously configured attention descriptor.

wKind

Input. Enumerant type to specify which weight or bias tensor should be retrieved.

weightSizeInBytes

Input. Buffer size that stores all multi-head attention weights and biases.

weights

Input. Pointer to the `weight` buffer in the host or device memory.

wDesc

Output. The descriptor specifying weight or bias tensor shape. For weights, the `wDesc.dimA[]` array has three elements: [`nHeads`, `projected size`, `original size`]. For biases, the `wDesc.dimA[]` array also has three elements: [`nHeads`, `projected size`, `1`]. The `wDesc.strideA[]` array describes how tensor elements are arranged in memory.

wAddr

Output. Pointer to a location where the start address of the requested tensor should be written. When the corresponding projection is disabled, the address written to `wAddr` is `NULL`.

Returns

CUDNN_STATUS_SUCCESS

The weight tensor descriptor and the address of data in the device memory were successfully retrieved.

CUDNN_STATUS_BAD_PARAM

An invalid or incompatible input argument was encountered. For example, `wKind` did not have a valid value or `weightSizeInBytes` was too small.

7.2.17. `cudaGetRNNBackwardDataAlgorithmMaxCount()`

This function has been deprecated in cuDNN 8.0.

7.2.18. `cudaGetRNNBiasMode()`

This function has been deprecated in cuDNN 8.0. Use [cudaGetRNNDescriptor_v8\(\)](#) instead of `cudaGetRNNBiasMode()`

```
cudaStatus_t cudaGetRNNBiasMode(
    cudaRNNDescriptor_t  rnnDesc,
    cudaRNNBiasMode_t   *biasMode)
```

This function retrieves the RNN bias mode that was configured by [cudaSetRNNBiasMode\(\)](#). The default value of `biasMode` in `rnnDesc` after [cudaCreateRNNDescriptor\(\)](#) is `CUDNN_RNN_DOUBLE_BIAS`.

Parameters

`rnnDesc`

Input. A previously created RNN descriptor.

`*biasMode`

Output. Pointer to where RNN bias mode should be saved.

Returns

CUDNN_STATUS_BAD_PARAM

Either the `rnnDesc` or `*biasMode` is NULL.

CUDNN_STATUS_SUCCESS

The `biasMode` parameter was retrieved successfully.

7.2.19. `cudaGetRNNDataDescriptor()`

```
cudaStatus_t cudaGetRNNDataDescriptor(
    cudaRNNDataDescriptor_t  RNNDataDesc,
    cudaDataType_t           *dataType,
    cudaRNNDataLayout_t     *layout,
```

```

int          *maxSeqLength,
int          *batchSize,
int          *vectorSize,
int          *arrayLengthRequested,
int          seqLengthArray[],
void        *paddingFill);

```

This function retrieves a previously created RNN data descriptor object.

Parameters

RNNDataDesc

Input. A previously created and initialized RNN descriptor.

dataType

Output. Pointer to the host memory location to store the datatype of the RNN data tensor.

layout

Output. Pointer to the host memory location to store the memory layout of the RNN data tensor.

maxSeqLength

Output. The maximum sequence length within this RNN data tensor, including the padding vectors.

batchSize

Output. The number of sequences within the mini-batch.

vectorSize

Output. The vector length (meaning, embedding size) of the input or output tensor at each time-step.

arrayLengthRequested

Input. The number of elements that the user requested for `seqLengthArray`.

seqLengthArray

Output. Pointer to the host memory location to store the integer array describing the length (meaning, number of time-steps) of each sequence. This is allowed to be a `NULL` pointer if `arrayLengthRequested` is 0.

paddingFill

Output. Pointer to the host memory location to store the user defined symbol. The symbol should be interpreted as the same data type as the RNN data tensor.

Returns

CUDNN_STATUS_SUCCESS

The parameters are fetched successfully.

CUDNN_STATUS_BAD_PARAM

Any one of these have occurred:

- ▶ Any of RNNDataDesc, dataType, layout, maxSeqLength, batchSize, vectorSize, paddingFill is NULL.
- ▶ seqLengthArray is NULL while arrayLengthRequested is greater than zero.
- ▶ arrayLengthRequested is less than zero.

7.2.20. cudnnGetRNNDescrptor_v6()

This function has been deprecated in cuDNN 8.0. Use [cudnnGetRNNDescrptor_v8\(\)](#) instead of `cudnnGetRNNDescrptor_v6()`.

```

cudnnStatus_t cudnnGetRNNDescrptor_v6(
    cudnnHandle_t handle,
    cudnnRNNDescrptor_t rnnDesc,
    int *hiddenSize,
    int *numLayers,
    cudnnDropoutDescrptor_t *dropoutDesc,
    cudnnRNNInputMode_t *inputMode,
    cudnnDirectionMode_t *direction,
    cudnnRNNMode_t *cellMode,
    cudnnRNNAlgo_t *algo,
    cudnnDataType_t *mathPrec) {

```

This function retrieves RNN network parameters that were configured by [cudnnSetRNNDescrptor_v6\(\)](#). All pointers passed to the function should be not-NULL or CUDNN_STATUS_BAD_PARAM is reported. The function does not check the validity of retrieved parameters.

Parameters

handle

Input. Handle to a previously created cuDNN library descriptor.

rnnDesc

Input. A previously created and initialized RNN descriptor.

hiddenSize

Output. Pointer to where the size of the hidden state should be stored (the same value is used in every RNN layer).

numLayers

Output. Pointer to where the number of RNN layers should be stored.

dropoutDesc

Output. Pointer to where the handle to a previously configured dropout descriptor should be stored.

inputMode

Output. Pointer to where the mode of the first RNN layer should be saved.

direction

Output. Pointer to where RNN uni-directional/bi-directional mode should be saved.

mode

Output. Pointer to where RNN cell type should be saved.

algo

Output. Pointer to where RNN algorithm type should be stored.

mathPrec

Output. Pointer to where the math precision type should be stored.

Returns**CUDNN_STATUS_SUCCESS**

RNN parameters were successfully retrieved from the RNN descriptor.

CUDNN_STATUS_BAD_PARAM

At least one pointer passed to the function is `NULL`.

7.2.21. cudnnGetRNNDescriptor_v8()

```
cudnnStatus_t cudnnGetRNNDescriptor_v8(
    cudnnRNNDescriptor_t rnnDesc,
    cudnnRNNAlgo_t *algo,
    cudnnRNNMode_t *cellMode,
    cudnnRNNBiasMode_t *biasMode,
    cudnnDirectionMode_t *dirMode,
    cudnnRNNInputMode_t *inputMode,
    cudnnDataType_t *dataType,
    cudnnDataType_t *mathPrec,
    cudnnMathType_t *mathType,
    int32_t *inputSize,
    int32_t *hiddenSize,
    int32_t *projSize,
    int32_t *numLayers,
    cudnnDropoutDescriptor_t *dropoutDesc,
    uint32_t *auxFlags);
```

This function retrieves RNN network parameters that were configured by [cudnnSetRNNDescriptor_v8\(\)](#). The user can assign `NULL` to any pointer except `rnnDesc` when the retrieved value is not needed. The function does not check the validity of retrieved parameters.

Parameters**rnnDesc**

Input. A previously created and initialized RNN descriptor.

algo

Output. Pointer to where RNN algorithm type should be stored.

cellMode

Output. Pointer to where RNN cell type should be saved.

biasMode

Output. Pointer to where RNN bias mode [cudaRNNBiasMode_t](#) should be saved.

dirMode

Output. Pointer to where RNN uni-directional/bi-directional mode should be saved.

inputMode

Output. Pointer to where the mode of the first RNN layer should be saved.

dataType

Output. Pointer to where the data type of RNN weights/biases should be stored.

mathPrec

Output. Pointer to where the math precision type should be stored.

mathType

Output. Pointer to where the preferred option for Tensor Cores are saved.

inputSize

Output. Pointer to where the RNN input vector size is stored.

hiddenSize

Output. Pointer to where the size of the hidden state should be stored (the same value is used in every RNN layer).

projSize

Output. Pointer to where the LSTM cell output size after the recurrent projection is stored.

numLayers

Output. Pointer to where the number of RNN layers should be stored.

dropoutDesc

Output. Pointer to where the handle to a previously configured dropout descriptor should be stored.

auxFlags

Output. Pointer to miscellaneous RNN options (flags) that do not require passing additional numerical values to configure.

Returns

CUDNN_STATUS_SUCCESS

RNN parameters were successfully retrieved from the RNN descriptor.

CUDNN_STATUS_BAD_PARAM

An invalid input argument was found (rnnDesc was NULL).

CUDNN_STATUS_NOT_INITIALIZED

The RNN descriptor was configured with the legacy [cudaSetRNNDescrptor_v6\(\)](#) call.

7.2.22. cudaGetRNNForwardInferenceAlgorithmMaxCount

This function has been deprecated in cuDNN 8.0.

7.2.23. cudaGetRNNForwardTrainingAlgorithmMaxCount (

This function has been deprecated in cuDNN 8.0.

7.2.24. cudaGetRNNLinLayerBiasParams (

This function has been deprecated in cuDNN 8.0. Use [cudaGetRNNWeightParams\(\)](#) instead of [cudaGetRNNLinLayerBiasParams\(\)](#).

```

cudaStatus_t cudaGetRNNLinLayerBiasParams (
    cudaHandle_t          handle,
    const cudaRNNDescrptor_t  rnnDesc,
    const int             pseudoLayer,
    const cudaTensorDescrptor_t  xDesc,
    const cudaFilterDescrptor_t  wDesc,
    const void           *w,
    const int            linLayerID,
    cudaFilterDescrptor_t  linLayerBiasDesc,
    void                 **linLayerBias)
    
```

This function is used to obtain a pointer and a descriptor of every RNN bias column vector in each pseudo-layer within the recurrent network defined by `rnnDesc` and its input width specified in `xDesc`.

Note: The [cudaGetRNNLinLayerBiasParams\(\)](#) function was changed in cuDNN version 7.1.1 to match the behavior of [cudaGetRNNLinLayerMatrixParams\(\)](#).

The [cudaGetRNNLinLayerBiasParams\(\)](#) function returns the RNN bias vector size in two dimensions: rows and columns.

Due to historical reasons, the minimum number of dimensions in the filter descriptor is three. In previous versions of the cuDNN library, the function returns the total number of vector elements in `linLayerBiasDesc` as follows:

```

filterDimA[0]=total_size,
filterDimA[1]=1,
filterDimA[2]=1
    
```

For more information, see the description of the [cudaGetFilterNdDescrptor\(\)](#) function.

In cuDNN 7.1.1, the format was changed to:

```

filterDimA[0]=1,
filterDimA[1]=rows,
filterDimA[2]=1 (number of columns)
    
```

In both cases, the `format` field of the filter descriptor should be ignored when retrieved by [cudaGetFilterNdDescrptor\(\)](#).

The RNN implementation in cuDNN uses two bias vectors before the cell non-linear function. Note that the RNN implementation in cuDNN depends on the number of bias vectors before the cell non-linear function. Refer to the equations in the [cudaRNNMode_t](#) description, for

the enumerant type based on the value of `cudnnRNNBiasMode_t` `biasMode` in `rnnDesc`. If nonexistent biases are referenced by `linLayerID`, then this function sets `linLayerBiasDesc` to a zeroed filter descriptor where:

```
filterDimA[0]=0,
filterDimA[1]=0, and
filterDimA[2]=2
```

and sets `linLayerBias` to `NULL`. Refer to the details for the function parameter `linLayerID` to determine the relevant values of `linLayerID` based on `biasMode`.

Parameters

handle

Input. Handle to a previously created cuDNN library descriptor.

rnnDesc

Input. A previously initialized RNN descriptor.

pseudoLayer

Input. The pseudo-layer to query. In uni-directional RNNs, a pseudo-layer is the same as a physical layer (`pseudoLayer=0` is the RNN input layer, `pseudoLayer=1` is the first hidden layer). In bi-directional RNNs, there are twice as many pseudo-layers in comparison to physical layers.

- ▶ `pseudoLayer=0` refers to the forward part of the physical input layer
- ▶ `pseudoLayer=1` refers to the backward part of the physical input layer
- ▶ `pseudoLayer=2` is the forward part of the first hidden layer, and so on

xDesc

Input. A fully packed tensor descriptor describing the input to one recurrent iteration (to retrieve the RNN input width).

wDesc

Input. Handle to a previously initialized filter descriptor describing the weights for the RNN.

w

Input. Data pointer to GPU memory associated with the filter descriptor `wDesc`.

linLayerID

Input. Linear ID index of the weight matrix.

If `cellMode` in `rnnDesc` was set to `CUDNN_RNN_RELU` or `CUDNN_RNN_TANH`:

- ▶ Value 0 references the weight matrix used in conjunction with the input from the previous layer or input to the RNN model.
- ▶ Value 1 references the weight matrix used in conjunction with the hidden state from the previous time step or the initial hidden state.

If `cellMode` in `rnnDesc` was set to `CUDNN_LSTM`:

- ▶ Values 0, 1, 2, and 3 reference weight matrices used in conjunction with the input from the previous layer or input to the RNN model.
- ▶ Values 4, 5, 6, and 7 reference weight matrices used in conjunction with the hidden state from the previous time step or the initial hidden state.
- ▶ Value 8 corresponds to the projection matrix, if enabled.

Values and their LSTM gates:

- ▶ `linLayerID0` and 4 correspond to the input gate.
- ▶ `linLayerID1` and 5 correspond to the forget gate.
- ▶ `linLayerID2` and 6 correspond to the new cell state calculations with a hyperbolic tangent.
- ▶ `linLayerID3` and 7 correspond to the output gate.

If `cellMode` in `rnnDesc` was set to `CUDNN_GRU`:

- ▶ Values 0, 1, and 2 reference weight matrices used in conjunction with the input from the previous layer or input to the RNN model.
- ▶ Values 3, 4, and 5 reference weight matrices used in conjunction with the hidden state from the previous time step or the initial hidden state.

Values and their GRU gates:

- ▶ `linLayerID0` and 3 correspond to the reset gate.
- ▶ `linLayerID1` and 4 references to the update gate.
- ▶ `linLayerID2` and 5 correspond to the new hidden state calculations with a hyperbolic tangent.

linLayerBiasDesc

Output. Handle to a previously created filter descriptor.

linLayerBias

Output. Data pointer to GPU memory associated with the filter descriptor `linLayerBiasDesc`.

Returns

CUDNN_STATUS_SUCCESS

The query was successful.

CUDNN_STATUS_NOT_SUPPORTED

The function does not support the provided configuration.

CUDNN_STATUS_BAD_PARAM

At least one of the following conditions are met:

- ▶ One of the following arguments is NULL: handle, rnnDesc, xDesc, wDesc, linLayerBiasDesc, linLayerBias.
- ▶ A data type mismatch was detected between rnnDesc and other descriptors.
- ▶ Minimum requirement for the w pointer alignment is not satisfied.
- ▶ The value of pseudoLayer or linLayerID is out of range.

CUDNN_STATUS_INVALID_VALUE

Some elements of the linLayerBias vector are outside the w buffer boundaries as specified by the wDesc descriptor.

7.2.25. cudnnGetRNNLinLayerMatrixParams ()

This function has been deprecated in cuDNN 8.0 . Use [cudnnGetRNNWeightParams\(\)](#) instead of [cudnnGetRNNLinLayerMatrixParams \(\)](#) .

```

cudnnStatus_t cudnnGetRNNLinLayerMatrixParams (
cudnnHandle_t      handle,
const cudnnRNNDescriptor_t  rnnDesc,
const int          pseudoLayer,
const cudnnTensorDescriptor_t  xDesc,
const cudnnFilterDescriptor_t  wDesc,
const void         *w,
const int          linLayerID,
cudnnFilterDescriptor_t  linLayerMatDesc,
void              **linLayerMat)
    
```

This function is used to obtain a pointer and a descriptor of every RNN weight matrix in each pseudo-layer within the recurrent network defined by rnnDesc and its input width specified in xDesc.

Note: The [cudnnGetRNNLinLayerMatrixParams\(\)](#) function was enhanced in cuDNN version 7.1.1 without changing its prototype. Instead of reporting the total number of elements in each weight matrix in the linLayerMatDesc filter descriptor, the function returns the matrix size as two dimensions: rows and columns. Moreover, when a weight matrix does not exist, for example, due to CUDNN_SKIP_INPUT mode, the function returns NULL in linLayerMat and all fields of linLayerMatDesc are zero.

The [cudnnGetRNNLinLayerMatrixParams\(\)](#) function returns the RNN matrix size in two dimensions: rows and columns. This allows the user to easily print and initialize RNN weight matrices. Elements in each weight matrix are arranged in the row-major order. Due to historical reasons, the minimum number of dimensions in the filter descriptor is three. In previous versions of the cuDNN library, the function returned the total number of weights in linLayerMatDesc as follows: filterDimA[0]=total_size, filterDimA[1]=1, filterDimA[2]=1 (see the description of the [cudnnGetFilterNdDescriptor\(\)](#) function). In cuDNN 7.1.1, the format was changed to: filterDimA[0]=1, filterDimA[1]=rows, filterDimA[2]=columns. In both cases, the "format" field of the filter descriptor should be ignored when retrieved by [cudnnGetFilterNdDescriptor\(\)](#).

Parameters

handle

Input. Handle to a previously created cuDNN library descriptor.

rnnDesc

Input. A previously initialized RNN descriptor.

pseudoLayer

Input. The pseudo-layer to query. In uni-directional RNNs, a pseudo-layer is the same as a physical layer (pseudoLayer=0 is the RNN input layer, pseudoLayer=1 is the first hidden layer). In bi-directional RNNs, there are twice as many pseudo-layers in comparison to physical layers.

- ▶ pseudoLayer=0 refers to the forward part of the physical input layer
- ▶ pseudoLayer=1 refers to the backward part of the physical input layer
- ▶ pseudoLayer=2 is the forward part of the first hidden layer, and so on

xDesc

Input. A fully packed tensor descriptor describing the input to one recurrent iteration (to retrieve the RNN input width).

wDesc

Input. Handle to a previously initialized filter descriptor describing the weights for the RNN.

w

Input. Data pointer to GPU memory associated with the filter descriptor wDesc.

linLayerID

Input. The linear layer to obtain information about:

- ▶ ▶ If mode in rnnDesc was set to CUDNN_RNN_RELU or CUDNN_RNN_TANH:
 - ▶ Value 0 references the bias applied to the input from the previous layer (relevant if biasMode in rnnDesc is CUDNN_RNN_SINGLE_INP_BIAS or CUDNN_RNN_DOUBLE_BIAS).
 - ▶ Value 1 references the bias applied to the recurrent input (relevant if biasMode in rnnDesc is CUDNN_RNN_DOUBLE_BIAS or CUDNN_RNN_SINGLE_REC_BIAS).
- ▶ If mode in rnnDesc was set to CUDNN_LSTM:
 - ▶ Values of 0, 1, 2 and 3 reference bias applied to the input from the previous layer (relevant if biasMode in rnnDesc is CUDNN_RNN_SINGLE_INP_BIAS or CUDNN_RNN_DOUBLE_BIAS).
 - ▶ Values of 4, 5, 6 and 7 reference bias applied to the recurrent input (relevant if biasMode in rnnDesc is CUDNN_RNN_DOUBLE_BIAS or CUDNN_RNN_SINGLE_REC_BIAS).

- ▶ Values and their associated gates:
 - ▶ Values 0 and 4 reference the input gate.
 - ▶ Values 1 and 5 reference the forget gate.
 - ▶ Values 2 and 6 reference the new memory gate.
 - ▶ Values 3 and 7 reference the output gate.
- ▶ If `mode` in `rnnDesc` was set to `CUDNN_GRU`:
 - ▶ Values of 0, 1 and 2 reference bias applied to the input from the previous layer (relevant if `biasMode` in `rnnDesc` is `CUDNN_RNN_SINGLE_INP_BIAS` or `CUDNN_RNN_DOUBLE_BIAS`).
 - ▶ Values of 3, 4 and 5 reference bias applied to the recurrent input (relevant if `biasMode` in `rnnDesc` is `CUDNN_RNN_DOUBLE_BIAS` or `CUDNN_RNN_SINGLE_REC_BIAS`).
 - ▶ Values and their associated gates:
 - ▶ Values 0 and 3 reference the reset gate.
 - ▶ Values 1 and 4 reference the update gate.
 - ▶ Values 2 and 5 reference the new memory gate.

For more information on modes and bias modes, see [cudaRNNMode_t](#).

linLayerMatDesc

Output. Handle to a previously created filter descriptor. When the weight matrix does not exist, the returned filter descriptor has all fields set to zero.

linLayerMat

Output. Data pointer to GPU memory associated with the filter descriptor `linLayerMatDesc`. When the weight matrix does not exist, the returned pointer is `NULL`.

Returns

CUDNN_STATUS_SUCCESS

The query was successful.

CUDNN_STATUS_NOT_SUPPORTED

The function does not support the provided configuration.

CUDNN_STATUS_BAD_PARAM

At least one of the following conditions are met:

- ▶ One of the following arguments is `NULL`: `handle`, `rnnDesc`, `xDesc`, `wDesc`, `linLayerMatDesc`, `linLayerMat`.
- ▶ A data type mismatch was detected between `rnnDesc` and other descriptors.
- ▶ Minimum requirement for the `w` pointer alignment is not satisfied.

- ▶ The value of `pseudoLayer` or `linLayerID` is out of range.

CUDNN_STATUS_INVALID_VALUE

Some elements of the `linLayerMat` vector are outside the `w` buffer boundaries as specified by the `wDesc` descriptor.

7.2.26. `cudaGetRNNMatrixMathType()`

This function has been deprecated in cuDNN 8.0. Use `cudaGetRNNDescriptor_v8()` instead of `cudaGetRNNMatrixMathType()`.

```
cudaStatus_t cudaGetRNNMatrixMathType(
    cudaRNNDescriptor_t rnnDesc,
    cudaMathType_t *mType);
```

This function retrieves the preferred settings for NVIDIA Tensor Cores on Volta (SM 7.0) or higher GPUs. See the `cudaMathType_t` description for more details.

Parameters

rnnDesc

Input. A previously created and initialized RNN descriptor.

mType

Output. Address where the preferred Tensor Core settings should be stored.

Returns

CUDNN_STATUS_SUCCESS

The requested RNN descriptor field was retrieved successfully.

CUDNN_STATUS_BAD_PARAM

An invalid input argument was found (`rnnDesc` or `mType` was `NULL`).

7.2.27. `cudaGetRNNPaddingMode()`

This function has been deprecated in cuDNN 8.0. Use `cudaGetRNNDescriptor_v8()` instead of `cudaGetRNNPaddingMode()`.

```
cudaStatus_t cudaGetRNNPaddingMode(
    cudaRNNDescriptor_t rnnDesc,
    cudaRNNPaddingMode_t *paddingMode)
```

This function retrieves the RNN padding mode from the RNN descriptor.

Parameters

rnnDesc

Input/Output. A previously created RNN descriptor.

***paddingMode**

Input. Pointer to the host memory where the RNN padding mode is saved.

Returns**CUDNN_STATUS_SUCCESS**

The RNN padding mode parameter was retrieved successfully.

CUDNN_STATUS_BAD_PARAM

Either the `rnnDesc` or `*paddingMode` is NULL.

7.2.28. cudnnGetRNNParamsSize()

This function has been deprecated in cuDNN 8.0. Use [cudnnGetRNNWeightSpaceSize\(\)](#) instead of `cudnnGetRNNParamsSize()`.

```
cudnnStatus_t cudnnGetRNNParamsSize(
    cudnnHandle_t      handle,
    const cudnnRNNDescriptor_t  rnnDesc,
    const cudnnTensorDescriptor_t  xDesc,
    size_t             *sizeInBytes,
    cudnnDataType_t    dataType)
```

This function is used to query the amount of parameter space required to execute the RNN described by `rnnDesc` with input dimensions defined by `xDesc`.

Parameters

`s`

handle

Input. Handle to a previously created cuDNN library descriptor.

rnnDesc

Input. A previously initialized RNN descriptor.

xDesc

Input. A fully packed tensor descriptor describing the input to one recurrent iteration.

sizeInBytes

Output. Minimum amount of GPU memory needed as parameter space to be able to execute an RNN with the specified descriptor and input tensors.

dataType

Input. The data type of the parameters.

Returns**CUDNN_STATUS_SUCCESS**

The query was successful.

CUDNN_STATUS_BAD_PARAM

At least one of the following conditions are met:

- ▶ The descriptor `rnnDesc` is invalid.
- ▶ The descriptor `xDesc` is invalid.
- ▶ The descriptor `xDesc` is not fully packed.
- ▶ The combination of `dataType` and tensor descriptor data type is invalid.

CUDNN_STATUS_NOT_SUPPORTED

The combination of the RNN descriptor and tensor descriptors is not supported.

7.2.29. `cudaGetRNNProjectionLayers()`

This function has been deprecated in cuDNN 8.0. Use [cudaGetRNNDescriptor_v8\(\)](#) instead of `cudaGetRNNProjectionLayers()`.

```

cudaStatus_t cudaGetRNNProjectionLayers(
    cudaHandle_t      handle,
    cudaRNNDescriptor_t  rnnDesc,
    int               *recProjSize,
    int               *outProjSize)
    
```

This function retrieves the current RNN projection parameters. By default, the projection feature is disabled so invoking this function will yield `recProjSize` equal to `hiddenSize` and `outProjSize` set to zero. The [cudaSetRNNProjectionLayers\(\)](#) method enables the RNN projection.

Parameters

handle

Input. Handle to a previously created cuDNN library descriptor.

rnnDesc

Input. A previously created and initialized RNN descriptor.

recProjSize

Output. Pointer where the recurrent projection size should be stored.

outProjSize

Output. Pointer where the output projection size should be stored.

Returns

CUDNN_STATUS_SUCCESS

RNN projection parameters were retrieved successfully.

CUDNN_STATUS_BAD_PARAM

A `NULL` pointer was passed to the function.

7.2.30. cudnnGetRNNTempSpaceSizes ()

```

cudnnStatus_t cudnnGetRNNTempSpaceSizes (
    cudnnHandle_t handle,
    cudnnRNNDescriptor_t rnnDesc,
    cudnnForwardMode_t fMode,
    cudnnRNNDataDescriptor_t xDesc,
    size_t *workSpaceSize,
    size_t *reserveSpaceSize);

```

This function computes the work and reserve space buffer sizes based on the RNN network geometry stored in `rnnDesc`, designated usage (inference or training) defined by the `fMode` argument, and the current RNN data dimensions (`maxSeqLength`, `batchSize`) retrieved from `xDesc`. When RNN data dimensions change, the `cudnnGetRNNTempSpaceSizes ()` must be called again because RNN temporary buffer sizes are not monotonic.

The user can assign `NULL` to `workSpaceSize` or `reserveSpaceSize` pointers when the corresponding value is not needed.

Parameters

handle

Input. The current cuDNN context handle.

rnnDesc

Input. A previously initialized RNN descriptor.

fMode

Input. Specifies whether temporary buffers are used in inference or training modes. The reserve-space buffer is not used during inference. Therefore, the returned size of the reserve space buffer will be zero when the `fMode` argument is `CUDNN_FWD_MODE_INFERENCE`.

xDesc

Input. A single RNN data descriptor that specifies current RNN data dimensions: `maxSeqLength` and `batchSize`.

workSpaceSize

Output. Minimum amount of GPU memory in bytes needed as a workspace buffer. The workspace buffer is not used to pass intermediate results between APIs but as a temporary read/write buffer.

reserveSpaceSize

Output. Minimum amount of GPU memory in bytes needed as the reserve-space buffer. The reserve space buffer is used to pass intermediate results from `cudnnRNNForward()` to RNN `BackwardData` and `BackwardWeights` routines that compute first order derivatives with respect to RNN inputs or trainable weight and biases.

Returns

CUDNN_STATUS_SUCCESS

RNN temporary buffer sizes were computed successfully.

CUDNN_STATUS_BAD_PARAM

An invalid input argument was detected.

CUDNN_STATUS_NOT_SUPPORTED

An incompatible or unsupported combination of input arguments was detected.

7.2.31. cudnnGetRNNWeightParams()

```

cudnnStatus_t cudnnGetRNNWeightParams(
    cudnnHandle_t handle,
    cudnnRNNDescriptor_t rnnDesc,
    int32_t pseudoLayer,
    size_t weightSpaceSize,
    const void *weightSpace,
    int32_t linLayerID,
    cudnnTensorDescriptor_t mDesc,
    void **mAddr,
    cudnnTensorDescriptor_t bDesc,
    void **bAddr);
    
```

This function is used to obtain the start address and shape of every RNN weight matrix and bias vector in each pseudo-layer within the recurrent network.

Parameters

handle

Input. Handle to a previously created cuDNN library descriptor.

rnnDesc

Input. A previously initialized RNN descriptor.

pseudoLayer

Input. The pseudo-layer to query. In uni-directional RNNs, a pseudo-layer is the same as a physical layer (pseudoLayer=0 is the RNN input layer, pseudoLayer=1 is the first hidden layer). In bi-directional RNNs, there are twice as many pseudo-layers in comparison to physical layers:

- ▶ pseudoLayer=0 refers to the forward direction sub-layer of the physical input layer
- ▶ pseudoLayer=1 refers to the backward direction sub-layer of the physical input layer
- ▶ pseudoLayer=2 is the forward direction sub-layer of the first hidden layer, and so on

weightSpaceSize

Input. Size of the weight space buffer in bytes.

weightSpace

Input. Pointer to the weight space buffer.

linLayerID

Input. Weight matrix or bias vector linear ID index.

If `cellMode` in `rnnDesc` was set to `CUDNN_RNN_RELU` or `CUDNN_RNN_TANH`:

- ▶ Value 0 references the weight matrix or bias vector used in conjunction with the input from the previous layer or input to the RNN model.
- ▶ Value 1 references the weight matrix or bias vector used in conjunction with the hidden state from the previous time step or the initial hidden state.

If `cellMode` in `rnnDesc` was set to `CUDNN_LSTM`:

- ▶ Values 0, 1, 2 and 3 reference weight matrices or bias vectors used in conjunction with the input from the previous layer or input to the RNN model.
- ▶ Values 4, 5, 6 and 7 reference weight matrices or bias vectors used in conjunction with the hidden state from the previous time step or the initial hidden state.
- ▶ Value 8 corresponds to the projection matrix, if enabled (there is no bias in this operation).

Values and their LSTM gates:

- ▶ `linLayerID0` and 4 correspond to the input gate.
- ▶ `linLayerID1` and 5 correspond to the forget gate.
- ▶ `linLayerID2` and 6 correspond to the new cell state calculations with hyperbolic tangent.
- ▶ `linLayerID3` and 7 correspond to the output gate.

If `cellMode` in `rnnDesc` was set to `CUDNN_GRU`:

- ▶ Values 0, 1 and 2 reference weight matrices or bias vectors used in conjunction with the input from the previous layer or input to the RNN model.
- ▶ Values 3, 4 and 5 reference weight matrices or bias vectors used in conjunction with the hidden state from the previous time step or the initial hidden state.

Values and their GRU gates:

- ▶ `linLayerID0` and 3 correspond to the reset gate.
- ▶ `linLayerID1` and 4 reference to the update gate.
- ▶ `linLayerID2` and 5 correspond to the new hidden state calculations with hyperbolic tangent.

For more information on modes and bias modes, see [cudaRNNMode_t](#).

mDesc

Output. Handle to a previously created tensor descriptor. The shape of the corresponding weight matrix is returned in this descriptor in the following format: `dimA[3] = {1, rows, cols}`. The reported number of tensor dimensions is zero when the weight matrix

does not exist. This situation occurs for input GEMM matrices of the first layer when `CUDNN_SKIP_INPUT` is selected or for the LSTM projection matrix when the feature is disabled.

mAddr

Output. Pointer to the beginning of the weight matrix within the weight space buffer. When the weight matrix does not exist, the returned address is `NULL`.

bDesc

Output. Handle to a previously created tensor descriptor. The shape of the corresponding bias vector is returned in this descriptor in the following format: `dimA[3] = {1, rows, 1}`. The reported number of tensor dimensions is zero when the bias vector does not exist.

bAddr

Output. Pointer to the beginning of the bias vector within the weight space buffer. When the bias vector does not exist, the returned address is `NULL`.

Returns

CUDNN_STATUS_SUCCESS

The query was completed successfully.

CUDNN_STATUS_BAD_PARAM

An invalid input argument was encountered. For example, the value of `pseudoLayer` is out of range or `linLayerID` is negative or larger than 8.

CUDNN_STATUS_INVALID_VALUE

Some weight/bias elements are outside the weight space buffer boundaries.

CUDNN_STATUS_NOT_INITIALIZED

The RNN descriptor was configured with the legacy [cudnnSetRNNDescriptor_v6\(\)](#) call.

7.2.32. cudnnGetRNNWeightSpaceSize()

```
cudnnStatus_t cudnnGetRNNWeightSpaceSize(
    cudnnHandle_t handle,
    cudnnRNNDescriptor_t rnnDesc,
    size_t *weightSpaceSize);
```

This function reports the required size of the weight space buffer in bytes. The weight space buffer holds all RNN weight matrices and bias vectors.

Parameters

handle

Input. The current cuDNN context handle.

rnnDesc

Input. A previously initialized RNN descriptor.

weightSpaceSize

Output. Minimum size in bytes of GPU memory needed for all RNN trainable parameters.

Returns

CUDNN_STATUS_SUCCESS

The query was successful.

CUDNN_STATUS_BAD_PARAM

An invalid input argument was encountered. For example, any input argument was NULL.

CUDNN_STATUS_NOT_INITIALIZED

The RNN descriptor was configured with the legacy [cudnnSetRNNDescrptor_v6\(\)](#) call.

7.2.33. **cudnnGetRNNWorkspaceSize()**

This function has been deprecated in cuDNN 8.0. Use [cudnnGetRNNTempSpaceSizes\(\)](#) instead of `cudnnGetRNNWorkspaceSize()`.

```

cudnnStatus_t cudnnGetRNNWorkspaceSize(
    cudnnHandle_t          handle,
    const cudnnRNNDescrptor_t  rnnDesc,
    const int              seqLength,
    const cudnnTensorDescrptor_t *xDesc,
    size_t                 *sizeInBytes)
    
```

This function is used to query the amount of work space required to execute the RNN described by `rnnDesc` with input dimensions defined by `xDesc`.

Parameters

handle

Input. Handle to a previously created cuDNN library descriptor.

rnnDesc

Input. A previously initialized RNN descriptor.

seqLength

Input. Number of iterations to unroll over. Workspace that is allocated, based on the size that this function provides, cannot be used for sequences longer than `seqLength`.

xDesc

Input. An array of tensor descriptors describing the input to each recurrent iteration (one descriptor per iteration). The first dimension (batch size) of the tensors may decrease from element `n` to element `n+1` but may not increase. For example, if you have multiple time series in a batch, they can be different lengths. This dimension is the batch size for the particular iteration of the sequence, and so it should decrease when a sequence in the batch has been terminated.

Each tensor descriptor must have the same second dimension (vector length).

sizeInBytes

Output. Minimum amount of GPU memory needed as workspace to be able to execute an RNN with the specified descriptor and input tensors.

Returns

CUDNN_STATUS_SUCCESS

The query was successful.

CUDNN_STATUS_BAD_PARAM

At least one of the following conditions are met:

- ▶ The descriptor `rnnDesc` is invalid.
- ▶ At least one of the descriptors in `xDesc` is invalid.
- ▶ The descriptors in `xDesc` have inconsistent second dimensions, strides or data types.
- ▶ The descriptors in `xDesc` have increasing first dimensions.
- ▶ The descriptors in `xDesc` are not fully packed.

CUDNN_STATUS_NOT_SUPPORTED

The data types in tensors described by `xDesc` are not supported.

7.2.34. **cudaGetSeqDataDescriptor()**

```

cudaStatus_t cudaGetSeqDataDescriptor(
    const cudaSeqDataDescriptor_t seqDataDesc,
    cudaDataType_t *dataType,
    int *nbDims,
    int nbDimsRequested,
    int dimA[],
    cudaSeqDataAxis_t axes[],
    size_t *seqLengthArraySize,
    size_t seqLengthSizeRequested,
    int seqLengthArray[],
    void *paddingFill);

```

This function retrieves settings from a previously created sequence data descriptor. The user can assign NULL to any pointer except `seqDataDesc` when the retrieved value is not needed. The `nbDimsRequested` argument applies to both `dimA[]` and `axes[]` arrays. A positive value of `nbDimsRequested` or `seqLengthSizeRequested` is ignored when the corresponding array, `dimA[]`, `axes[]`, or `seqLengthArray[]` is NULL.

The `cudaGetSeqDataDescriptor()` function does not report the actual strides in the sequence data buffer. Those strides can be handy in computing the offset to any sequence data element. The user must precompute strides based on the `axes[]` and `dimA[]` arrays reported by the `cudaGetSeqDataDescriptor()` function. Below is sample code that performs this task:

```

// Array holding sequence data strides.
size_t strA[CUDNN_SEQDATA_DIM_COUNT] = {0};

// Compute strides from dimension and order arrays.
size_t stride = 1;
for (int i = nbDims - 1; i >= 0; i--) {
    int j = int(axes[i]);

```

```

if (unsigned(j) < CUDNN_SEQDATA_DIM_COUNT-1 && strA[j] == 0) {
    strA[j] = stride;
    stride *= dimA[j];
} else {
    fprintf(stderr, "ERROR: invalid axes[%d]=%d\n\n", i, j);
    abort();
}
}
}

```

Now, the `strA[]` array can be used to compute the index to any sequence data element, for example:

```

// Using four indices (batch, beam, time, vect) with ranges already checked.
size_t base = strA[CUDNN_SEQDATA_BATCH_DIM] * batch
             + strA[CUDNN_SEQDATA_BEAM_DIM] * beam
             + strA[CUDNN_SEQDATA_TIME_DIM] * time;
val = seqDataPtr[base + vect];

```

The above code assumes that all four indices (`batch`, `beam`, `time`, `vect`) are less than the corresponding value in the `dimA[]` array. The sample code also omits the `strA[CUDNN_SEQDATA_VECT_DIM]` stride because its value is always 1, meaning, elements of one vector occupy a contiguous block of memory.

Parameters

seqDataDesc

Input. Sequence data descriptor.

dataType

Output. Data type used in the sequence data buffer.

nbDims

Output. The number of active dimensions in the `dimA[]` and `axes[]` arrays.

nbDimsRequested

Input. The maximum number of consecutive elements that can be written to `dimA[]` and `axes[]` arrays starting from index zero. The recommended value for this argument is `CUDNN_SEQDATA_DIM_COUNT`.

dimA[]

Output. Integer array holding sequence data dimensions.

axes[]

Output. Array of `cudaAdvSeqDataAxis_t` that defines the layout of sequence data in memory.

seqLengthArraySize

Output. The number of required elements in `seqLengthArray[]` to save all sequence lengths.

seqLengthSizeRequested

Input. The maximum number of consecutive elements that can be written to the `seqLengthArray[]` array starting from index zero.

seqLengthArray[]

Output. Integer array holding sequence lengths.

paddingFill

Output. Pointer to a storage location of `dataType` with the fill value that should be written to all padding vectors. Use `NULL` when an explicit initialization of output padding vectors was not requested.

Returns

CUDNN_STATUS_SUCCESS

Requested sequence data descriptor fields were retrieved successfully.

CUDNN_STATUS_BAD_PARAM

An invalid input argument was found.

CUDNN_STATUS_INTERNAL_ERROR

An inconsistent internal state was encountered.

7.2.35. cudnnMultiHeadAttnForward()

```

cudnnStatus_t cudnnMultiHeadAttnForward(
    cudnnHandle_t handle,
    const cudnnAttnDescriptor_t attnDesc,
    int currIdx,
    const int loWinIdx[],
    const int hiWinIdx[],
    const int devSeqLengthsQO[],
    const int devSeqLengthsKV[],
    const cudnnSeqDataDescriptor_t qDesc,
    const void *queries,
    const void *residuals,
    const cudnnSeqDataDescriptor_t kDesc,
    const void *keys,
    const cudnnSeqDataDescriptor_t vDesc,
    const void *values,
    const cudnnSeqDataDescriptor_t oDesc,
    void *out,
    size_t weightSizeInBytes,
    const void *weights,
    size_t workSpaceSizeInBytes,
    void *workSpace,
    size_t reserveSpaceSizeInBytes,
    void *reserveSpace);
    
```

The `cudnnMultiHeadAttnForward()` function computes the forward responses of the multi-head attention layer. When `reserveSpaceSizeInBytes=0` and `reserveSpace=NULL`, the function operates in the inference mode in which backward (gradient) functions are not invoked, otherwise, the training mode is assumed. In the training mode, the reserve space is used to pass intermediate results from `cudnnMultiHeadAttnForward()` to `cudnnMultiHeadAttnBackwardData()` and from `cudnnMultiHeadAttnBackwardData()` to `cudnnMultiHeadAttnBackwardWeights()`.

In the inference mode, the `currIdx` specifies the time-step or sequence index of the embedding vectors to be processed. In this mode, the user can perform one iteration for time-step zero (`currIdx=0`), then update **Q**, **K**, **V** vectors and the attention window, and execute the next step (`currIdx=1`). The iterative process can be repeated for all time-steps.

When all **Q** time-steps are available (for example, in the training mode or in the inference mode on the encoder side in self-attention), the user can assign a negative value to `currIdx` and the `cudnnMultiHeadAttnForward()` API will automatically sweep through all **Q** time-steps.

The `loWinIdx[]` and `hiWinIdx[]` host arrays specify the attention window size for each **Q** time-step. In a typical self-attention case, the user must include all previously visited embedding vectors but not the current or future vectors. In this situation, the user should set:

```
currIdx=0: loWinIdx[0]=0; hiWinIdx[0]=0; // initial time-step, no attention window
currIdx=1: loWinIdx[1]=0; hiWinIdx[1]=1; // attention window spans one vector
currIdx=2: loWinIdx[2]=0; hiWinIdx[2]=2; // attention window spans two vectors
(...)
```

When `currIdx` is negative in `cudaMultiHeadAttnForward()`, the `loWinIdx[]` and `hiWinIdx[]` arrays must be fully initialized for all time-steps. When `cudaMultiHeadAttnForward()` is invoked with `currIdx=0`, `currIdx=1`, `currIdx=2`, etc., then the user can update `loWinIdx[currIdx]` and `hiWinIdx[currIdx]` elements only before invoking the forward response function. All other elements in the `loWinIdx[]` and `hiWinIdx[]` arrays will not be accessed. Any adaptive attention window scheme can be implemented that way.

Use the following settings when the attention window should be the maximum size, for example, in cross-attention:

```
currIdx=0: loWinIdx[0]=0; hiWinIdx[0]=maxSeqLenK;
currIdx=1: loWinIdx[1]=0; hiWinIdx[1]=maxSeqLenK;
currIdx=2: loWinIdx[2]=0; hiWinIdx[2]=maxSeqLenK;
(...)
```

The `maxSeqLenK` value above should be equal to or larger than `dimA[CUDNN_SEQDATA_TIME_DIM]` in the `kDesc` descriptor. A good choice is to use `maxSeqLenK=INT_MAX` from `limits.h`.

Note: The actual length of any **K** sequence defined in `seqLengthArray[]` in `cudaSetSeqDataDescriptor()` can be shorter than `maxSeqLenK`. The effective attention window span is computed based on `seqLengthArray[]` stored in the **K** sequence descriptor and indices held in `loWinIdx[]` and `hiWinIdx[]` arrays.

`devSeqLengthsQO[]` and `devSeqLengthsKV[]` are pointers to device (not host) arrays with **Q**, **O**, and **K**, **V** sequence lengths. Note that the same information is also passed in the corresponding descriptors of type `cudaSeqDataDescriptor_t` on the host side. The need for extra device arrays comes from the asynchronous nature of cuDNN calls and limited size of the constant memory dedicated to GPU kernel arguments. When the `cudaMultiHeadAttnForward()` API returns, the sequence length arrays stored in the descriptors can be immediately modified for the next iteration. However, the GPU kernels launched by the forward call may not have started at this point. For this reason, copies of sequence arrays are needed on the device side to be accessed directly by GPU kernels. Those copies cannot be created inside the `cudaMultiHeadAttnForward()` function for very large **K**, **V** inputs without the device memory allocation and CUDA stream synchronization.

To reduce the `cudaMultiHeadAttnForward()` API overhead, `devSeqLengthsQO[]` and `devSeqLengthsKV[]` device arrays are not validated to contain the same settings as `seqLengthArray[]` in the sequence data descriptors.

Sequence lengths in the `kDesc` and `vDesc` descriptors should be the same. Similarly, sequence lengths in the `qDesc` and `oDesc` descriptors should match. The user can define six different data layouts in the `qDesc`, `kDesc`, `vDesc` and `oDesc` descriptors. See the `cudaSetSeqDataDescriptor()` function for the discussion of those layouts. All multi-head attention API calls require that the same layout is used in all sequence data descriptors.

In the transformer model, the multi-head attention block is tightly coupled with the layer normalization and residual connections. `cudaMultiHeadAttnForward()` does not encompass the layer normalization but it can be used to handle residual connections as depicted in the following figure.

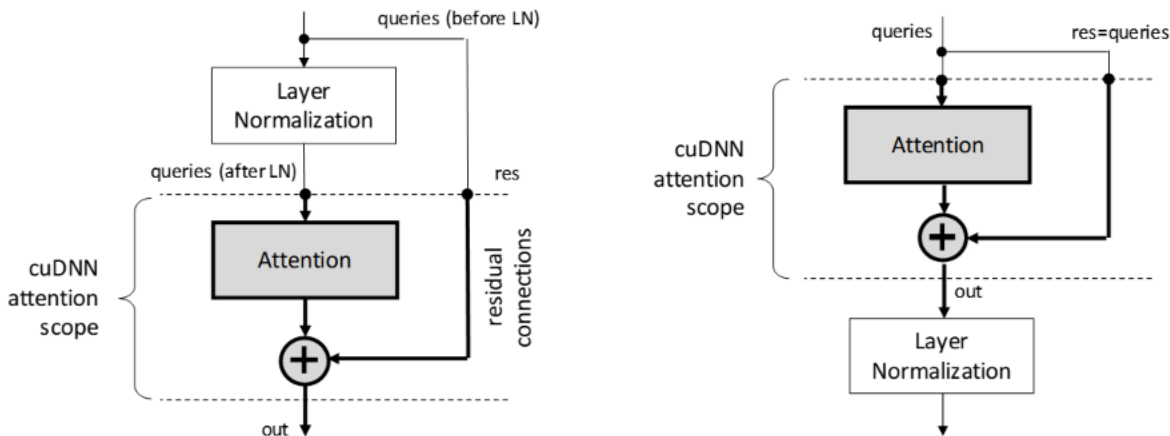

Queries and residuals share the same `qDesc` descriptor in `cudaMultiHeadAttnForward()`. When residual connections are disabled, the residuals pointer should be `NULL`. When residual connections are enabled, the vector length in `qDesc` should match the vector length specified in the `oDesc` descriptor, so that a vector addition is feasible.

The `queries`, `keys`, and `values` pointers are not allowed to be `NULL`, even when **K** and **V** are the same inputs or **Q**, **K**, **V** are the same inputs.

Parameters

handle

Input. The current cuDNN context handle.

attnDesc

Input. A previously initialized attention descriptor.

currIdx

Input. Time-step in queries to process. When the `currIdx` argument is negative, all **Q** time-steps are processed. When `currIdx` is zero or positive, the forward response is computed for the selected time-step only. The latter input can be used in inference mode only, to process one time-step while updating the next attention window and **Q**, **R**, **K**, **V** inputs in-between calls.

loWinIdx[], hiWinIdx[]

Input. Two host integer arrays specifying the start and end indices of the attention window for each **Q** time-step. The start index in **K**, **V** sets is inclusive, and the end index is exclusive.

devSeqLengthsQO[]

Input. Device array specifying sequence lengths of query, residual, and output sequence data.

devSeqLengthsKV[]

Input. Device array specifying sequence lengths of key and value input data.

qDesc

Input. Descriptor for the query and residual sequence data.

queries

Input. Pointer to queries data in the device memory.

residuals

Input. Pointer to residual data in device memory. Set this argument to `NULL` if no residual connections are required.

kDesc

Input. Descriptor for the keys sequence data.

keys

Input. Pointer to keys data in device memory.

vDesc

Input. Descriptor for the values sequence data.

values

Input. Pointer to values data in device memory.

oDesc

Input. Descriptor for the multi-head attention output sequence data.

out

Output. Pointer to device memory where the output response should be written.

weightSizeInBytes

Input. Size of the weight buffer in bytes where all multi-head attention trainable parameters are stored.

weights

Input. Pointer to the weight buffer in device memory.

workspaceSizeInBytes

Input. Size of the work-space buffer in bytes used for temporary API storage.

workspace

Input/Output. Pointer to the work-space buffer in device memory.

reserveSpaceSizeInBytes

Input. Size of the reserve-space buffer in bytes used for data exchange between forward and backward (gradient) API calls. This parameter should be zero in the inference mode and non-zero in the training mode.

reserveSpace

Input/Output. Pointer to the reserve-space buffer in device memory. This argument should be NULL in inference mode and non-NULL in the training mode.

Returns

CUDNN_STATUS_SUCCESS

No errors were detected while processing API input arguments and launching GPU kernels.

CUDNN_STATUS_BAD_PARAM

An invalid or incompatible input argument was encountered. Some examples include:

- ▶ a required input pointer was NULL
- ▶ currIdx was out of bound
- ▶ the descriptor value for attention, query, key, value, and output were incompatible with one another

CUDNN_STATUS_EXECUTION_FAILED

The process of launching a GPU kernel returned an error, or an earlier kernel did not complete successfully.

CUDNN_STATUS_INTERNAL_ERROR

An inconsistent internal state was encountered.

CUDNN_STATUS_NOT_SUPPORTED

A requested option or a combination of input arguments is not supported.

CUDNN_STATUS_ALLOC_FAILED

Insufficient amount of shared memory to launch a GPU kernel.

7.2.36. cudnnRNNForward()

```

cudnnStatus_t cudnnRNNForward(
    cudnnHandle_t handle,
    cudnnRNNDescriptor_t rnnDesc,
    cudnnForwardMode_t fwdMode,
    const int32_t devSeqLengths[],
    cudnnRNNDataDescriptor_t xDesc,
    const void *x,
    cudnnRNNDataDescriptor_t yDesc,
    void *y,
    cudnnTensorDescriptor_t hDesc,
    const void *hx,
    void *hy,
    cudnnTensorDescriptor_t cDesc,
    const void *cx,
    void *cy,
    size_t weightSpaceSize,
    const void *weightSpace,
    size_t workSpaceSize,
    void *workSpace,
    size_t reserveSpaceSize,
    void *reserveSpace);
    
```

This routine computes the forward response of the recurrent neural network described by `rnnDesc` with inputs in `x`, `hx`, `cx`, and weights/biases in the `weightSpace` buffer. RNN outputs are written to `y`, `hy`, and `cy` buffers. Locations of `x`, `y`, `hx`, `cx`, `hy`, and `cy` signals in the multi-layer RNN model are shown in the Figure below. Note that internal RNN signals between time-steps and between layers are not exposed to the user.

Figure 1. Locations of `x`, `y`, `hx`, `cx`, `hy`, and `cy` signals in the multi-layer RNN model.

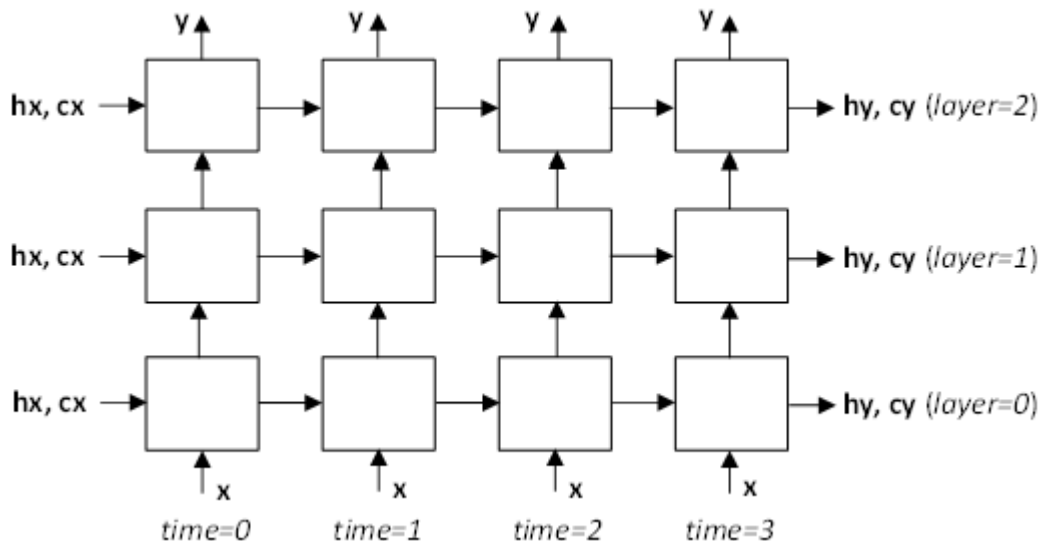

The next Figure depicts data flow when the RNN model is bi-directional. In this mode each RNN physical layer consists of two consecutive pseudo-layers, each with its own weights, biases, the initial hidden state `hx`, and for LSTM, also the initial cell state `cx`. Even pseudo-layers 0, 2, 4 process input vectors from left to right or in the forward (`F`) direction. Odd pseudo-layers 1, 3, 5 process input vectors from right to left or in the reverse (`R`) direction. Two successive pseudo-layers operate on the same input vectors, just in a different order. Pseudo-layers 0 and 1 access the original sequences stored in the `x` buffer. Outputs of `F` and `R` cells are concatenated so vectors fed to the next two pseudo-layers have lengths of $2 \times \text{hiddenSize}$ or $2 \times \text{projSize}$. Input GEMMs in subsequent pseudo-layers adjust vector lengths to $1 \times \text{hiddenSize}$.

Figure 2. Data flow when the RNN model is bi-directional.

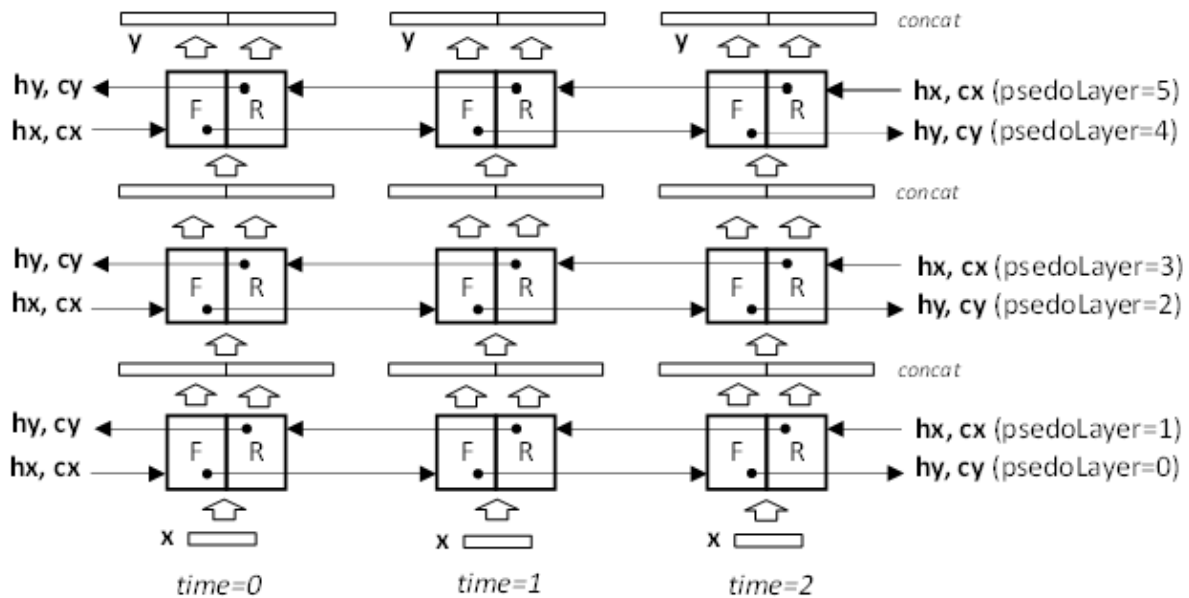

When the `fwdMode` parameter is set to `CUDNN_FWD_MODE_TRAINING`, the `cudaRNNForward()` function stores intermediate data required to compute first order derivatives in the reserve space buffer. Work and reserve space buffer sizes should be computed by the [cudaGetRNNTempSpaceSizes\(\)](#) function with the same `fwdMode` setting as used in the `cudaRNNForward()` call.

The same layout type must be specified in `xDesc` and `yDesc` descriptors. The same sequence lengths must be configured in `xDesc`, `yDesc` and in the device array `devSeqLengths`. The `cudaRNNForward()` function does not verify that sequence lengths stored in `devSeqLengths` in GPU memory are the same as in `xDesc` and `yDesc` descriptors in CPU memory. Sequence length arrays from `xDesc` and `yDesc` descriptors are checked for consistency, however.

Parameters

handle

Input. The current cuDNN context handle.

rnnDesc

Input. A previously initialized RNN descriptor.

fwdMode

Input. Specifies inference or training mode (`CUDNN_FWD_MODE_INFERENCE` and `CUDNN_FWD_MODE_TRAINING`). In the training mode, additional data is stored in the reserve space buffer. This information is used in the backward pass to compute derivatives.

devSeqLengths

Input. A copy of `seqLengthArray` from `xDesc` or `yDesc` RNN data descriptor. The `devSeqLengths` array must be stored in GPU memory as it is accessed asynchronously by

GPU kernels, possibly after the `cudaRNNForward()` function exists. This argument cannot be `NULL`.

xDesc

Input. A previously initialized descriptor corresponding to the RNN model primary input. The `dataType`, `layout`, `maxSeqLength`, `batchSize`, and `seqLengthArray` must match that of `yDesc`. The parameter `vectorSize` must match the `inputSize` argument passed to the [cudaSetRNNDescriptor_v8\(\)](#) function.

x

Input. Data pointer to the GPU memory associated with the RNN data descriptor `xDesc`. The vectors are expected to be arranged in memory according to the layout specified by `xDesc`. The elements in the tensor (including padding vectors) must be densely packed.

yDesc

Input. A previously initialized RNN data descriptor. The `dataType`, `layout`, `maxSeqLength`, `batchSize`, and `seqLengthArray` must match that of `xDesc`. The parameter `vectorSize` depends on whether LSTM projection is enabled and whether the network is bidirectional. Specifically:

- ▶ For unidirectional models, the parameter `vectorSize` must match the `hiddenSize` argument passed to [cudaSetRNNDescriptor_v8\(\)](#). If the LSTM projection is enabled, the `vectorSize` must be the same as the `projSize` argument passed to [cudaSetRNNDescriptor_v8\(\)](#).
- ▶ For bidirectional models, if the RNN `cellMode` is `CUDNN_LSTM` and the projection feature is enabled, the parameter `vectorSize` must be 2x the `projSize` argument passed to [cudaSetRNNDescriptor_v8\(\)](#). Otherwise, it should be 2x the `hiddenSize` value.

y

Output. Data pointer to the GPU memory associated with the RNN data descriptor `yDesc`. The vectors are expected to be laid out in memory according to the layout specified by `yDesc`. The elements in the tensor (including elements in the padding vector) must be densely packed, and no strides are supported.

hDesc

Input. A tensor descriptor describing the initial or final hidden state of RNN. Hidden state data are fully packed. The first dimension of the tensor depends on the `dirMode` argument passed to the [cudaSetRNNDescriptor_v8\(\)](#) function.

- ▶ If `dirMode` is `CUDNN_UNIDIRECTIONAL`, then the first dimension should match the `numLayers` argument passed to [cudaSetRNNDescriptor_v8\(\)](#).
- ▶ If `dirMode` is `CUDNN_BIDIRECTIONAL`, then the first dimension should be double the `numLayers` argument passed to [cudaSetRNNDescriptor_v8\(\)](#).

The second dimension must match the `batchSize` parameter described in `xDesc`. The third dimension depends on whether RNN mode is `CUDNN_LSTM` and whether the LSTM projection is enabled. Specifically:

- ▶ If RNN mode is `CUDNN_LSTM` and LSTM projection is enabled, the third dimension must match the `projSize` argument passed to the [`cudaSetRNNProjectionLayers\(\)`](#) call.
- ▶ Otherwise, the third dimension must match the `hiddenSize` argument passed to the [`cudaSetRNNDescriptor_v8\(\)`](#) call used to initialize `rnnDesc`.

hx

Input. Pointer to the GPU buffer with the RNN initial hidden state. Data dimensions are described by the `hDesc` tensor descriptor. If a `NULL` pointer is passed, the initial hidden state of the network will be initialized to zero.

hy

Output. Pointer to the GPU buffer where the final RNN hidden state should be stored. Data dimensions are described by the `hDesc` tensor descriptor. If a `NULL` pointer is passed, the final hidden state of the network will not be saved.

cDesc

Input. For LSTM networks only. A tensor descriptor describing the initial or final cell state for LSTM networks only. Cell state data are fully packed. The first dimension of the tensor depends on the `dirMode` argument passed to the [`cudaSetRNNDescriptor_v8\(\)`](#) call.

- ▶ If `dirMode` is `CUDNN_UNIDIRECTIONAL` the first dimension should match the `numLayers` argument passed to [`cudaSetRNNDescriptor_v8\(\)`](#).
- ▶ If `dirMode` is `CUDNN_BIDIRECTIONAL` the first dimension should match double the `numLayers` argument passed to [`cudaSetRNNDescriptor_v8\(\)`](#).

The second tensor dimension must match the `batchSize` parameter in `xDesc`. The third dimension must match the `hiddenSize` argument passed to the [`cudaSetRNNDescriptor_v8\(\)`](#) call.

cx

Input. For LSTM networks only. Pointer to the GPU buffer with the initial LSTM state data. Data dimensions are described by the `cDesc` tensor descriptor. If a `NULL` pointer is passed, the initial cell state of the network will be initialized to zero.

cy

Output. For LSTM networks only. Pointer to the GPU buffer where final LSTM state data should be stored. Data dimensions are described by the `cDesc` tensor descriptor. If a `NULL` pointer is passed, the final LSTM cell state will not be saved.

weightSpaceSize

Input. Specifies the size in bytes of the provided weight-space buffer.

weightSpace

Input. Address of the weight space buffer in GPU memory.

workSpaceSize

Input. Specifies the size in bytes of the provided workspace buffer.

workSpace

Input/Output. Address of the workspace buffer in GPU memory to store temporary data.

reserveSpaceSize

Input. Specifies the size in bytes of the reserve-space buffer.

reserveSpace

Input/Output. Address of the reserve-space buffer in GPU memory.

Returns**CUDNN_STATUS_SUCCESS**

No errors were detected while processing API input arguments and launching GPU kernels.

CUDNN_STATUS_NOT_SUPPORTED

At least one of the following conditions are met:

- ▶ variable sequence length input is passed while CUDNN_RNN_ALGO_PERSIST_STATIC or CUDNN_RNN_ALGO_PERSIST_DYNAMIC is specified
- ▶ CUDNN_RNN_ALGO_PERSIST_STATIC or CUDNN_RNN_ALGO_PERSIST_DYNAMIC is requested on pre-Pascal devices
- ▶ the 'double' floating point type is used for input/output and the CUDNN_RNN_ALGO_PERSIST_STATIC algo

CUDNN_STATUS_BAD_PARAM

An invalid or incompatible input argument was encountered. For example:

- ▶ some input descriptors are NULL
- ▶ at least one of the settings in rnnDesc, xDesc, yDesc, hDesc, or cDesc descriptors is invalid
- ▶ weightSpaceSize, workSpaceSize, or reserveSpaceSize is too small

CUDNN_STATUS_EXECUTION_FAILED

The process of launching a GPU kernel returned an error, or an earlier kernel did not complete successfully.

CUDNN_STATUS_ALLOC_FAILED

The function was unable to allocate CPU memory.

7.2.37. cudnnRNNForwardInference ()

This function has been deprecated in cuDNN 8.0. Use [cudnnRNNForward\(\)](#) instead of `cudnnRNNForwardInference()`.

```

cudnnStatus_t cudnnRNNForwardInference (
    cudnnHandle_t          handle,
    const cudnnRNNDescriptor_t  rnnDesc,
    const int              seqLength,
    const cudnnTensorDescriptor_t *xDesc,
    const void             *x,
    const cudnnTensorDescriptor_t hxDesc,
    const void             *hx,
    const cudnnTensorDescriptor_t cxDesc,
    const void             *cx,
    const cudnnFilterDescriptor_t wDesc,
    const void             *w,
    const cudnnTensorDescriptor_t *yDesc,
    void                  *y,
    const cudnnTensorDescriptor_t hyDesc,
    void                  *hy,
    const cudnnTensorDescriptor_t cyDesc,
    void                  *cy,
    void                  *workspace,
    size_t                 workspaceSizeInBytes)
    
```

This routine executes the recurrent neural network described by `rnnDesc` with inputs `x`, `hx`, and `cx`, weights `w` and outputs `y`, `hy`, and `cy`. `workspace` is required for intermediate storage. This function does not store intermediate data required for training; [cudnnRNNForwardTraining\(\)](#) should be used for that purpose.

Parameters

handle

Input. Handle to a previously created cuDNN context.

rnnDesc

Input. A previously initialized RNN descriptor.

seqLength

Input. Number of iterations to unroll over. The value of this `seqLength` must not exceed the value that was used in [cudnnGetRNNWorkspaceSize\(\)](#) function for querying the workspace size required to execute the RNN.

xDesc

Input. An array of `seqLength` fully packed tensor descriptors. Each descriptor in the array should have three dimensions that describe the input data format to one recurrent iteration (one descriptor per RNN time-step). The first dimension (batch size) of the tensors may decrease from iteration `n` to iteration `n+1` but may not increase. Each tensor descriptor must have the same second dimension (RNN input vector length, `inputSize`). The third dimension of each tensor should be 1. Input data are expected to be arranged in the column-major order so strides in `xDesc` should be set as follows:

```
strideA[0]=inputSize, strideA[1]=1, strideA[2]=1
```

x

Input. Data pointer to GPU memory associated with the array of tensor descriptors `xDesc`. The input vectors are expected to be packed contiguously with the first vector of iteration (time-step) $n+1$ following directly from the last vector of iteration n . In other words, input vectors for all RNN time-steps should be packed in the contiguous block of GPU memory with no gaps between the vectors.

hxDesc

Input. A fully packed tensor descriptor describing the initial hidden state of the RNN. The first dimension of the tensor depends on the `direction` argument used to initialize `rnnDesc`:

- ▶ If `direction` is `CUDNN_UNIDIRECTIONAL` the first dimension should match the `numLayers` argument.
- ▶ If `direction` is `CUDNN_BIDIRECTIONAL` the first dimension should match double the `numLayers` argument.

The second dimension must match the first dimension of the tensors described in `xDesc`. The third dimension must match the `hiddenSize` argument used to initialize `rnnDesc`. The tensor must be fully packed.

hx

Input. Data pointer to GPU memory associated with the tensor descriptor `hxDesc`. If a `NULL` pointer is passed, the initial hidden state of the network will be initialized to zero.

cxDesc

Input. A fully packed tensor descriptor describing the initial cell state for LSTM networks. The first dimension of the tensor depends on the `direction` argument used to initialize `rnnDesc`:

- ▶ If `direction` is `CUDNN_UNIDIRECTIONAL` the first dimension should match the `numLayers` argument.
- ▶ If `direction` is `CUDNN_BIDIRECTIONAL` the first dimension should match double the `numLayers` argument.

The second dimension must match the first dimension of the tensors described in `xDesc`. The third dimension must match the `hiddenSize` argument used to initialize `rnnDesc`. The tensor must be fully packed.

cx

Input. Data pointer to GPU memory associated with the tensor descriptor `cxDesc`. If a `NULL` pointer is passed, the initial cell state of the network will be initialized to zero.

wDesc

Input. Handle to a previously initialized filter descriptor describing the weights for the RNN.

w

Input. Data pointer to GPU memory associated with the filter descriptor `wDesc`.

yDesc

Input. An array of fully packed tensor descriptors describing the output from each recurrent iteration (one descriptor per iteration). The second dimension of the tensor depends on the `direction` argument used to initialize `rnnDesc`:

- ▶ If `direction` is `CUDNN_UNIDIRECTIONAL` the second dimension should match the `hiddenSize` argument.
- ▶ If `direction` is `CUDNN_BIDIRECTIONAL` the second dimension should match double the `hiddenSize` argument.

The first dimension of the tensor `n` must match the first dimension of the tensor `n` in `xDesc`.

y

Output. Data pointer to GPU memory associated with the output tensor descriptor `yDesc`. The data are expected to be packed contiguously with the first element of iteration `n+1` following directly from the last element of iteration `n`.

hyDesc

Input. A fully packed tensor descriptor describing the final hidden state of the RNN. The first dimension of the tensor depends on the `direction` argument used to initialize `rnnDesc`:

- ▶ If `direction` is `CUDNN_UNIDIRECTIONAL` the first dimension should match the `numLayers` argument.
- ▶ If `direction` is `CUDNN_BIDIRECTIONAL` the first dimension should match double the `numLayers` argument.

The second dimension must match the first dimension of the tensors described in `xDesc`. The third dimension must match the `hiddenSize` argument used to initialize `rnnDesc`. The tensor must be fully packed.

hy

Output. Data pointer to GPU memory associated with the tensor descriptor `hyDesc`. If a `NULL` pointer is passed, the final hidden state of the network will not be saved.

cyDesc

Input. A fully packed tensor descriptor describing the final cell state for LSTM networks. The first dimension of the tensor depends on the `direction` argument used to initialize `rnnDesc`:

- ▶ If `direction` is `CUDNN_UNIDIRECTIONAL` the first dimension should match the `numLayers` argument.
- ▶ If `direction` is `CUDNN_BIDIRECTIONAL` the first dimension should match double the `numLayers` argument.

The second dimension must match the first dimension of the tensors described in `xDesc`. The third dimension must match the `hiddenSize` argument used to initialize `rnnDesc`. The tensor must be fully packed.

cy

Output. Data pointer to GPU memory associated with the tensor descriptor `cyDesc`. If a `NULL` pointer is passed, the final cell state of the network will not be saved.

workspace

Input. Data pointer to GPU memory to be used as a workspace for this call.

workSpaceSizeInBytes

Input. Specifies the size in bytes of the provided `workspace`.

Returns**CUDNN_STATUS_SUCCESS**

The function launched successfully.

CUDNN_STATUS_NOT_SUPPORTED

The function does not support the provided configuration.

CUDNN_STATUS_BAD_PARAM

At least one of the following conditions are met:

- ▶ The descriptor `rnnDesc` is invalid.
- ▶ At least one of the descriptors `hxDesc`, `cxDesc`, `wDesc`, `hyDesc`, `cyDesc` or one of the descriptors in `xDesc`, `yDesc` is invalid.
- ▶ The descriptors in one of `xDesc`, `hxDesc`, `cxDesc`, `wDesc`, `yDesc`, `hyDesc`, `cyDesc` have incorrect strides or dimensions.
- ▶ `workSpaceSizeInBytes` is too small.

CUDNN_STATUS_INVALID_VALUE

[`cudnnSetPersistentRNNPlan\(\)`](#) was not called prior to the current function when `CUDNN_RNN_ALGO_PERSIST_DYNAMIC` was selected in the RNN descriptor.

CUDNN_STATUS_EXECUTION_FAILED

The function failed to launch on the GPU.

CUDNN_STATUS_ALLOC_FAILED

The function was unable to allocate memory.

7.2.38. `cudnnRNNForwardInferenceEx()`

This function has been deprecated in cuDNN 8.0. Use [`cudnnRNNForward\(\)`](#) instead of `cudnnRNNForwardInference()`.

```

cudaStatus_t cudaRNNTForwardInferenceEx(
    cudaHandle_t          handle,
    const cudaRNNDesc_t   rnnDesc,
    const cudaRNNDDataDesc_t xDesc,
    const void            *x,
    const cudaTensorDesc_t hxDesc,
    const void            *hx,
    const cudaTensorDesc_t cxDesc,
    const void            *cx,
    const cudaFilterDesc_t wDesc,
    const void            *w,
    const cudaRNNDDataDesc_t yDesc,
    void                  *y,
    const cudaTensorDesc_t hyDesc,
    void                  *hy,
    const cudaTensorDesc_t cyDesc,
    void                  *cy,
    const cudaRNNDDataDesc_t kDesc,
    const void            *keys,
    const cudaRNNDDataDesc_t cDesc,
    void                  *cAttn,
    const cudaRNNDDataDesc_t iDesc,
    void                  *iAttn,
    const cudaRNNDDataDesc_t qDesc,
    void                  *queries,
    void                  *workSpace,
    size_t                workspaceSizeInBytes)

```

This routine is the extended version of the [cudaRNNTForwardInference\(\)](#) function. The `cudaRNNTForwardTrainingEx()` function allows the user to use an unpacked (padded) layout for input `x` and output `y`. In the unpacked layout, each sequence in the mini-batch is considered to be of fixed length, specified by `maxSeqLength` in its corresponding `RNNDDataDescriptor`. Each fixed-length sequence, for example, the `n`th sequence in the mini-batch, is composed of a valid segment, specified by the `seqLengthArray[n]` in its corresponding `RNNDDataDescriptor`, and a padding segment to make the combined sequence length equal to `maxSeqLength`.

With unpacked layout, both sequence major (meaning, time major) and batch major are supported. For backward compatibility, the packed sequence major layout is supported. However, similar to the non-extended function [cudaRNNTForwardInference\(\)](#), the sequences in the mini-batch need to be sorted in descending order according to length.

Parameters

handle

Input. Handle to a previously created cuDNN context.

rnnDesc

Input. A previously initialized RNN descriptor.

xDesc

Input. A previously initialized RNN Data descriptor. The `dataType`, `layout`, `maxSeqLength`, `batchSize`, and `seqLengthArray` need to match that of `yDesc`.

x

Input. Data pointer to the GPU memory associated with the RNN data descriptor `xDesc`. The vectors are expected to be laid out in memory according to the layout specified by `xDesc`.

The elements in the tensor (including elements in the padding vector) must be densely packed, and no strides are supported.

hxDesc

Input. A fully packed tensor descriptor describing the initial hidden state of the RNN. The first dimension of the tensor depends on the `direction` argument used to initialize `rnnDesc`:

- ▶ If `direction` is `CUDNN_UNIDIRECTIONAL` the first dimension should match the `numLayers` argument.
- ▶ If `direction` is `CUDNN_BIDIRECTIONAL` the first dimension should match double the `numLayers` argument.

The second dimension must match the `batchSize` parameter described in `xDesc`. The third dimension depends on whether RNN mode is `CUDNN_LSTM` and whether LSTM projection is enabled. Specifically:

- ▶ If RNN mode is `CUDNN_LSTM` and LSTM projection is enabled, the third dimension must match the `recProjSize` argument passed to `cudaSetRNNProjectionLayers()` call used to set `rnnDesc`.
- ▶ Otherwise, the third dimension must match the `hiddenSize` argument used to initialize `rnnDesc`.

hx

Input. Data pointer to GPU memory associated with the tensor descriptor `hxDesc`. If a `NULL` pointer is passed, the initial hidden state of the network will be initialized to zero.

cxDesc

Input. A fully packed tensor descriptor describing the initial cell state for LSTM networks. The first dimension of the tensor depends on the `direction` argument used to initialize `rnnDesc`:

- ▶ If `direction` is `CUDNN_UNIDIRECTIONAL` the first dimension should match the `numLayers` argument.
- ▶ If `direction` is `CUDNN_BIDIRECTIONAL` the first dimension should match double the `numLayers` argument.

The second dimension must match the `batchSize` parameter in `xDesc`. The third dimension must match the `hiddenSize` argument used to initialize `rnnDesc`.

cx

Input. Data pointer to GPU memory associated with the tensor descriptor `cxDesc`. If a `NULL` pointer is passed, the initial cell state of the network will be initialized to zero.

wDesc

Input. Handle to a previously initialized filter descriptor describing the weights for the RNN.

w

Input. Data pointer to GPU memory associated with the filter descriptor `wDesc`.

yDesc

Input. A previously initialized RNN data descriptor. The `dataType`, `layout`, `maxSeqLength`, `batchSize`, and `seqLengthArray` must match that of `dyDesc` and `dxDesc`. The parameter `vectorSize` depends on whether RNN mode is `CUDNN_LSTM` and whether LSTM projection is enabled and whether the network is bidirectional. Specifically:

- ▶ For unidirectional network, if the RNN mode is `CUDNN_LSTM` and LSTM projection is enabled, the parameter `vectorSize` must match the `recProjSize` argument passed to [cudnnSetRNNProjectionLayers\(\)](#) call used to set `rnnDesc`. If the network is bidirectional, then multiply the value by 2.
- ▶ Otherwise, for a unidirectional network, the parameter `vectorSize` must match the `hiddenSize` argument used to initialize `rnnDesc`. If the network is bidirectional, then multiply the value by 2.

y

Output. Data pointer to the GPU memory associated with the RNN data descriptor `yDesc`. The vectors are expected to be laid out in memory according to the layout specified by `yDesc`. The elements in the tensor (including elements in the padding vector) must be densely packed, and no strides are supported.

hyDesc

Input. A fully packed tensor descriptor describing the final hidden state of the RNN. The descriptor must be set exactly the same way as `hxDesc`.

hy

Output. Data pointer to GPU memory associated with the tensor descriptor `hyDesc`. If a `NULL` pointer is passed, the final hidden state of the network will not be saved.

cyDesc

Input. A fully packed tensor descriptor describing the final cell state for LSTM networks. The descriptor must be set exactly the same way as `cxDesc`.

cy

Output. Data pointer to GPU memory associated with the tensor descriptor `cyDesc`. If a `NULL` pointer is passed, the final cell state of the network will not be saved.

kDesc

Reserved. User may pass in `NULL`.

keys

Reserved. Users may pass in `NULL`.

cDesc

Reserved. Users may pass in `NULL`.

cAttn

Reserved. Users may pass in NULL.

iDesc

Reserved. Users may pass in NULL.

iAttn

Reserved. Users may pass in NULL.

qDesc

Reserved. Users may pass in NULL.

queries

Reserved. Users may pass in NULL.

workspace

Input. Data pointer to GPU memory to be used as a workspace for this call.

workSpaceSizeInBytes

Input. Specifies the size in bytes of the provided workspace.

Returns**CUDNN_STATUS_SUCCESS**

The function launched successfully.

CUDNN_STATUS_NOT_SUPPORTED

At least one of the following conditions are met:

- ▶ Variable sequence length input is passed in while CUDNN_RNN_ALGO_PERSIST_STATIC or CUDNN_RNN_ALGO_PERSIST_DYNAMIC is used.
- ▶ CUDNN_RNN_ALGO_PERSIST_STATIC or CUDNN_RNN_ALGO_PERSIST_DYNAMIC is used on pre-Pascal devices.
- ▶ Double input/output is used for CUDNN_RNN_ALGO_PERSIST_STATIC.

CUDNN_STATUS_BAD_PARAM

At least one of the following conditions are met:

- ▶ The descriptor rnnDesc is invalid.
- ▶ At least one of the descriptors in xDesc, yDesc, hxDesc, cxDesc, wDesc, hyDesc, cyDesc is invalid, or have incorrect strides or dimensions.
- ▶ reserveSpaceSizeInBytes is too small.
- ▶ workSpaceSizeInBytes is too small.

CUDNN_STATUS_INVALID_VALUE

[cudaSetPersistentRNNPlan\(\)](#) was not called prior to the current function when CUDNN_RNN_ALGO_PERSIST_DYNAMIC was selected in the RNN descriptor.

CUDNN_STATUS_EXECUTION_FAILED

The function failed to launch on the GPU.

CUDNN_STATUS_ALLOC_FAILED

The function was unable to allocate memory.

7.2.39. **cudaRNNGetClip()**

This function has been deprecated in cuDNN 8.0. Use [cudaRNNGetClip_v8\(\)](#) instead of `cudaRNNGetClip()`.

```

cudaStatus_t cudaRNNGetClip(
    cudaHandle_t      handle,
    cudaRNNDescriptor_t  rnnDesc,
    cudaRNNGetClipMode_t  *clipMode,
    cudaRNNGetClipNanOpt_t *clipNanOpt,
    double            *lclip,
    double            *rclip);
    
```

Retrieves the current LSTM cell clipping parameters, and stores them in the arguments provided.

Parameters

***clipMode**

Output. Pointer to the location where the retrieved `clipMode` is stored. The `clipMode` can be CUDNN_RNN_CLIP_NONE in which case no LSTM cell state clipping is being performed; or CUDNN_RNN_CLIP_MINMAX, in which case the cell state activation to other units are being clipped.

***lclip, *rclip**

Output. Pointers to the location where the retrieved LSTM cell clipping range [`lclip`, `rclip`] is stored.

***clipNanOpt**

Output. Pointer to the location where the retrieved `clipNanOpt` is stored.

Returns

CUDNN_STATUS_SUCCESS

The function launched successfully.

CUDNN_STATUS_BAD_PARAM

If any of the pointer arguments provided are NULL.

7.2.40. cudnnRNNGetClip_v8()

```

cudnnStatus_t cudnnRNNGetClip_v8(
    cudnnRNNDescriptor_t rnnDesc,
    cudnnRNNClipMode_t *clipMode,
    cudnnNanPropagation_t *clipNanOpt,
    double *lclip,
    double *rclip);

```

Retrieves the current LSTM cell clipping parameters, and stores them in the arguments provided. The user can assign NULL to any pointer except `rnnDesc` when the retrieved value is not needed. The function does not check the validity of retrieved parameters.

Parameters

rnnDesc

Input. A previously initialized RNN descriptor.

clipMode

Output. Pointer to the location where the retrieved `cudnnRNNClipMode_t` value is stored. The `clipMode` can be `CUDNN_RNN_CLIP_NONE` in which case no LSTM cell state clipping is being performed; or `CUDNN_RNN_CLIP_MINMAX`, in which case the cell state activation to other units are being clipped.

clipNanOpt

Output. Pointer to the location where the retrieved `cudnnNanPropagation_t` value is stored.

lclip, rclip

Output. Pointers to the location where the retrieved LSTM cell clipping range [`lclip`, `rclip`] is stored.

Returns

CUDNN_STATUS_SUCCESS

LSTM clipping parameters were successfully retrieved from the RNN descriptor.

CUDNN_STATUS_BAD_PARAM

An invalid input argument was found (`rnnDesc` was NULL).

7.2.41. cudnnRNNSetClip()

This function has been deprecated in cuDNN 8.0. Use [cudnnRNNSetClip_v8\(\)](#) instead of `cudnnRNNSetClip()`.

```

cudnnStatus_t cudnnRNNSetClip(
    cudnnHandle_t          handle,
    cudnnRNNDescriptor_t  rnnDesc,
    cudnnRNNClipMode_t    clipMode,
    cudnnNanPropagation_t clipNanOpt,
    double                 lclip,
    double                 rclip);

```

Sets the LSTM cell clipping mode. The LSTM clipping is disabled by default. When enabled, clipping is applied to all layers. This `cudaRNNSetClip()` function may be called multiple times.

Parameters

clipMode

Input. Enables or disables the LSTM cell clipping. When `clipMode` is set to `CUDNN_RNN_CLIP_NONE` no LSTM cell state clipping is performed. When `clipMode` is `CUDNN_RNN_CLIP_MINMAX` the cell state activation to other units is clipped.

lclip, rclip

Input. The range [`lclip`, `rclip`] to which the LSTM cell clipping should be set.

clipNanOpt

Input. When set to `CUDNN_PROPAGATE_NAN` (see the description for [cudaNanPropagation_t](#)), NaN is propagated from the LSTM cell, or it can be set to one of the clipping range boundary values, instead of propagating.

Returns

CUDNN_STATUS_SUCCESS

The function launched successfully.

CUDNN_STATUS_BAD_PARAM

Returns this value if `lclip > rclip`; or if either `lclip` or `rclip` is NaN.

7.2.42. `cudaRNNSetClip_v8()`

```
cudaStatus_t cudaRNNSetClip_v8(
    cudaRNNDescriptor_t rnnDesc,
    cudaRNNClipMode_t clipMode,
    cudaNanPropagation_t clipNanOpt,
    double lclip,
    double rclip);
```

Sets the LSTM cell clipping mode. The LSTM clipping is disabled by default. When enabled, clipping is applied to all layers. This `cudaRNNSetClip()` function does not affect the work, reserve, and weight-space buffer sizes and may be called multiple times.

Parameters

rnnDesc

Input. A previously initialized RNN descriptor.

clipMode

Input. Enables or disables the LSTM cell clipping. When `clipMode` is set to `CUDNN_RNN_CLIP_NONE` no LSTM cell state clipping is performed. When `clipMode` is `CUDNN_RNN_CLIP_MINMAX` the cell state activation to other units is clipped.

clipNanOpt

Input. When set to CUDNN_PROPAGATE_NAN (see the description for [cudaNanPropagation_t](#)), NaN is propagated from the LSTM cell, or it can be set to one of the clipping range boundary values, instead of propagating.

lclip, rclip

Input. The range [lclip, rclip] to which the LSTM cell clipping should be set.

Returns

CUDNN_STATUS_SUCCESS

The function completed successfully.

CUDNN_STATUS_BAD_PARAM

An invalid input argument was found, for example:

- ▶ rnnDesc was NULL
- ▶ lclip > rclip
- ▶ either lclip or rclip is NaN

CUDNN_STATUS_BAD_PARAM

The dimensions of the bias tensor refer to an amount of data that is incompatible with the output tensor dimensions or the dataType of the two tensor descriptors are different.

CUDNN_STATUS_EXECUTION_FAILED

The function failed to launch on the GPU.

7.2.43. cudnnSetAttnDescriptor()

```

cudaStatus_t cudnnSetAttnDescriptor(
    cudaAttnDescriptor_t attnDesc,
    unsigned attnMode,
    int nHeads,
    double smScaler,
    cudaDataType_t dataType,
    cudaDataType_t computePrec,
    cudaMathType_t mathType,
    cudaDropoutDescriptor_t attnDropoutDesc,
    cudaDropoutDescriptor_t postDropoutDesc,
    int qSize,
    int kSize,
    int vSize,
    int qProjSize,
    int kProjSize,
    int vProjSize,
    int oProjSize,
    int qoMaxSeqLength,
    int kvMaxSeqLength,
    int maxBatchSize,
    int maxBeamSize);
    
```

This function configures a multi-head attention descriptor that was previously created using the [cudaCreateAttnDescriptor\(\)](#) function. The function sets attention parameters that are

necessary to compute internal buffer sizes, dimensions of weight and bias tensors, or to select optimized code paths.

Input sequence data descriptors in [cudaMultiHeadAttnForward\(\)](#), [cudaMultiHeadAttnBackwardData\(\)](#) and [cudaMultiHeadAttnBackwardWeights\(\)](#) functions are checked against the configuration parameters stored in the attention descriptor. Some parameters must match exactly while `max` arguments such as `maxBatchSize` or `qoMaxSeqLength` establish upper limits for the corresponding dimensions.

The multi-head attention model can be described by the following equations:

$$\mathbf{h}_i = (\mathbf{W}_{V,i}\mathbf{V}) \text{softmax}(\text{smScaler}(\mathbf{K}^T\mathbf{W}_{K,i}^T)(\mathbf{W}_{Q,i}\mathbf{q})), \text{ for } i = 0 \dots \text{nHeads} - 1$$

$$\text{MultiHeadAttn}(\mathbf{q}, \mathbf{K}, \mathbf{V}, \mathbf{W}_Q, \mathbf{W}_K, \mathbf{W}_V, \mathbf{W}_O) = \sum_{i=0}^{\text{nHeads}-1} \mathbf{W}_{O,i}\mathbf{h}_i$$

Where:

- ▶ `nHeads` is the number of independent attention heads that evaluate \mathbf{h}_i vectors.
- ▶ \mathbf{q} is a primary input, a single query column vector.
- ▶ \mathbf{K}, \mathbf{V} are two matrices of key and value column vectors.

For simplicity, the above equations are presented using a single embedding vector \mathbf{q} but the API can handle multiple \mathbf{q} candidates in the beam search scheme, process \mathbf{q} vectors from multiple sequences bundled into a batch, or automatically iterate through all embedding vectors (time-steps) of a sequence. Thus, in general, $\mathbf{q}, \mathbf{K}, \mathbf{V}$ inputs are tensors with additional pieces of information such as the active length of each sequence or how unused padding vectors should be saved.

In some publications, $\mathbf{W}_{O,i}$ matrices are combined into one output projection matrix and \mathbf{h}_i vectors are merged explicitly into a single vector. This is an equivalent notation. In the library, $\mathbf{W}_{O,i}$ matrices are conceptually treated the same way as $\mathbf{W}_{Q,i}, \mathbf{W}_{K,i}$ or $\mathbf{W}_{V,i}$ input projection weights. See the description of the [cudaGetMultiHeadAttnWeights\(\)](#) function for more details.

Weight matrices $\mathbf{W}_{Q,i}, \mathbf{W}_{K,i}, \mathbf{W}_{V,i}$ and $\mathbf{W}_{O,i}$ play similar roles, adjusting vector lengths in $\mathbf{q}, \mathbf{K}, \mathbf{V}$ inputs and in the multi-head attention final output. The user can disable any or all projections by setting `qProjSize`, `kProjSize`, `vProjSize` or `oProjSize` arguments to zero.

Embedding vector sizes in $\mathbf{q}, \mathbf{K}, \mathbf{V}$ and the vector lengths after projections need to be selected in such a way that matrix multiplications described above are feasible. Otherwise, `CUDNN_STATUS_BAD_PARAM` is returned by the `cudaSetAttnDescriptor()` function. All four weight matrices are used when it is desirable to maintain rank deficiency of $\mathbf{W}_{KQ,i} = \mathbf{W}_{K,i}^T\mathbf{W}_{Q,i}$ or $\mathbf{W}_{OV,i} = \mathbf{W}_{O,i}\mathbf{W}_{V,i}$ matrices to eliminate one or more dimensions during linear transformations in each head. This is a form of feature extraction. In such cases, the projected sizes are smaller than the original vector lengths.

For each attention head, weight matrix sizes are defined as follows:

- ▶ $\mathbf{W}_{Q,i}$ - size [`qProjSize x qSize`], $i = 0 \dots \text{nHeads} - 1$
- ▶ $\mathbf{W}_{K,i}$ - size [`kProjSize x kSize`], $i = 0 \dots \text{nHeads} - 1$, `kProjSize = qProjSize`
- ▶ $\mathbf{W}_{V,i}$ - size [`vProjSize x vSize`], $i = 0 \dots \text{nHeads} - 1$

► $\mathbf{W}_{0,i}$ - size [oProjSize x (vProjSize > 0 ? vProjSize : vSize)], $i = 0..nHeads-1$

When the output projection is disabled (oProjSize = 0), the output vector length is $nHeads * (vProjSize > 0 ? vProjSize : vSize)$, meaning, the output is a concatenation of all \mathbf{h}_i vectors. In the alternative interpretation, a concatenated matrix $\mathbf{W}_0 = [\mathbf{W}_{0,0}, \mathbf{W}_{0,1}, \mathbf{W}_{0,2}, \dots]$ forms the identity matrix.

Softmax is a normalized, exponential vector function that takes and outputs vectors of the same size. The multi-head attention API utilizes softmax of the CUDNN_SOFTMAX_ACCURATE type to reduce the likelihood of the floating-point overflow.

The smScaler parameter is the softmax sharpening/smoothing coefficient. When smScaler=1.0, softmax uses the natural exponential function $\exp(x)$ or 2.7183^x . When smScaler<1.0, for example smScaler=0.2, the function used by the softmax block will not grow as fast because $\exp(0.2 * x) \approx 1.2214^x$.

The smScaler parameter can be adjusted to process larger ranges of values fed to softmax. When the range is too large (or smScaler is not sufficiently small for the given range), the output vector of the softmax block becomes categorical, meaning, one vector element is close to 1.0 and other outputs are zero or very close to zero. When this occurs, the Jacobian matrix of the softmax block is also close to zero so deltas are not back-propagated during training from output to input except through residual connections, if these connections are enabled. The user can set smScaler to any positive floating-point value or even zero. The smScaler parameter is not trainable.

The qoMaxSeqLength, kvMaxSeqLength, maxBatchSize, and maxBeamSize arguments declare the maximum sequence lengths, maximum batch size, and maximum beam size respectively, in the [cudaSeqDataDescriptor_t](#) containers. The actual dimensions supplied to forward and backward (gradient) API functions should not exceed the max limits. The max arguments should be set carefully because too large values will result in excessive memory usage due to oversized work and reserve space buffers.

The attnMode argument is treated as a binary mask where various on/off options are set. These options can affect the internal buffer sizes, enforce certain argument checks, select optimized code execution paths, or enable attention variants that do not require additional numerical arguments. An example of such options is the inclusion of biases in input and output projections.

The attnDropoutDesc and postDropoutDesc arguments are descriptors that define two dropout layers active in the training mode. The first dropout operation defined by attnDropoutDesc, is applied directly to the softmax output. The second dropout operation, specified by postDropoutDesc, alters the multi-head attention output, just before the point where residual connections are added.



Note: The `cudaSetAttnDescriptor()` function performs a shallow copy of `attnDropoutDesc` and `postDropoutDesc`, meaning, the addresses of both dropout descriptors are stored in the attention descriptor and not the entire structure. Therefore, the user should keep dropout descriptors during the entire life of the attention descriptor.

Parameters

attnDesc

Output. Attention descriptor to be configured.

attnMode

Input. Enables various attention options that do not require additional numerical values. See the table below for the list of supported flags. The user should assign a preferred set of bitwise OR-ed flags to this argument.

nHeads

Input. Number of attention heads.

smScaler

Input. Softmax smoothing ($1.0 \geq \text{smScaler} \geq 0.0$) or sharpening ($\text{smScaler} > 1.0$) coefficient. Negative values are not accepted.

dataType

Input. Data type used to represent attention inputs, attention weights and attention outputs.

computePrec

Input. Compute precision.

mathType

Input. NVIDIA Tensor Core settings.

attnDropoutDesc

Input. Descriptor of the dropout operation applied to the softmax output. See the table below for a list of unsupported features.

postDropoutDesc

Input. Descriptor of the dropout operation applied to the multi-head attention output, just before the point where residual connections are added. See the table below for a list of unsupported features.

qSize, kSize, vSize

Input. **Q**, **K**, **V** embedding vector lengths.

qProjSize, kProjSize, vProjSize

Input. **Q**, **K**, **V** embedding vector lengths after input projections. Use zero to disable the corresponding projection.

oProjSize

Input. The \mathbf{h}_i vector length after the output projection. Use zero to disable this projection.

qoMaxSeqLength

Input. Largest sequence length expected in sequence data descriptors related to **Q**, **O**, **dQ** and **dO** inputs and outputs.

kvMaxSeqLength

Input. Largest sequence length expected in sequence data descriptors related to **K, V, dK** and **dV** inputs and outputs.

maxBatchSize

Input. Largest batch size expected in any `cudaSeqDataDescriptor_t` container.

maxBeamSize

Input. Largest beam size expected in any `cudaSeqDataDescriptor_t` container.

Supported `attnMode` flags

CUDNN_ATTN_QUERYMAP_ALL_TO_ONE

Forward declaration of mapping between **Q** and **K, V** vectors when the beam size is greater than one in the **Q** input. Multiple **Q** vectors from the same beam bundle map to the same **K, V** vectors. This means that beam sizes in the **K, V** sets are equal to one.

CUDNN_ATTN_QUERYMAP_ONE_TO_ONE

Forward declaration of mapping between **Q** and **K, V** vectors when the beam size is greater than one in the **Q** input. Multiple **Q** vectors from the same beam bundle map to different **K, V** vectors. This requires beam sizes in **K, V** sets to be the same as in the **Q** input.

CUDNN_ATTN_DISABLE_PROJ_BIASES

Use no biases in the attention input and output projections.

CUDNN_ATTN_ENABLE_PROJ_BIASES

Use extra biases in the attention input and output projections. In this case the projected $\bar{\mathbf{K}}$ vectors are computed as $\bar{\mathbf{K}}_i = \mathbf{W}_{K,i} \mathbf{K} + \mathbf{b} * [1, 1, \dots, 1]_{1 \times n}$, where n is the number of columns in the **K** matrix. In other words, the same column vector **b** is added to all columns of **K** after the weight matrix multiplication.

Supported combinations of `dataType`, `computePrec`, and `mathType`

Table 41. Supported combinations

dataType	computePrec	mathType
CUDNN_DATA_DOUBLE	CUDNN_DATA_DOUBLE	CUDNN_DEFAULT_MATH
CUDNN_DATA_FLOAT	CUDNN_DATA_FLOAT	CUDNN_DEFAULT_MATH, CUDNN_TENSOR_OP_MATH_ALLOW_CONVERSION
CUDNN_DATA_HALF	CUDNN_DATA_HALF	CUDNN_DEFAULT_MATH, CUDNN_TENSOR_OP_MATH, CUDNN_TENSOR_OP_MATH_ALLOW_CONVERSION

Unsupported features

1. The dropout option is currently not supported by the multi-head attention API. Assign `NULL` to `attnDropoutDesc` and `postDropoutDesc` arguments when configuring the attention descriptor.
2. The `CUDNN_ATTN_ENABLE_PROJ_BIASES` option is not supported in the multi-head attention gradient functions.
3. The `paddingFill` argument in `cudaSeqDataDescriptor_t` is currently ignored by all multi-head attention functions.

Returns

CUDNN_STATUS_SUCCESS

The attention descriptor was configured successfully.

CUDNN_STATUS_BAD_PARAM

An invalid input argument was encountered. Some examples include:

- ▶ post projection **Q** and **K** sizes were not equal
- ▶ `dataType`, `computePrec`, or `mathType` were invalid
- ▶ one or more of the following arguments were either negative or zero: `nHeads`, `qSize`, `kSize`, `vSize`, `qoMaxSeqLength`, `kvMaxSeqLength`, `maxBatchSize`, `maxBeamSize`
- ▶ one or more of the following arguments were negative: `qProjSize`, `kProjSize`, `vProjSize`, `smScaler`

CUDNN_STATUS_NOT_SUPPORTED

A requested option or a combination of input arguments is not supported.

7.2.44. `cudaSetPersistentRNNPlan()`

This function has been deprecated in cuDNN 8.0.

```
cudaStatus_t cudaSetPersistentRNNPlan(
    cudaRNNDescriptor_t   rnnDesc,
    cudaPersistentRNNPlan_t plan)
```

This function sets the persistent RNN plan to be executed when using `rnnDesc` and `CUDNN_RNN_ALGO_PERSIST_DYNAMIC` algo.

Returns

CUDNN_STATUS_SUCCESS

The plan was set successfully.

CUDNN_STATUS_BAD_PARAM

The algo selected in `rnnDesc` is not `CUDNN_RNN_ALGO_PERSIST_DYNAMIC`.

7.2.45. `cudaSetRNNAlgorithmDescriptor()`

This function has been deprecated in cuDNN 8.0.

7.2.46. `cudaSetRNNBiasMode()`

This function has been deprecated in cuDNN 8.0. Use [cudaSetRNNDescriptor_v8\(\)](#) instead of `cudaSetRNNBiasMode()`.

```
cudaStatus_t cudaSetRNNBiasMode(
    cudaRNNDescriptor_t  rnnDesc,
    cudaRNNBiasMode_t   biasMode)
```

The `cudaSetRNNBiasMode()` function sets the number of bias vectors for a previously created and initialized RNN descriptor. This function should be called to enable the specified bias mode in an RNN. The default value of `biasMode` in `rnnDesc` after [cudaCreateRNNDescriptor\(\)](#) is `CUDNN_RNN_DOUBLE_BIAS`.

Parameters

rnnDesc

Input/Output. A previously created RNN descriptor.

biasMode

Input. Sets the number of bias vectors. For more information, see [cudaRNNBiasMode_t](#).

Returns

CUDNN_STATUS_BAD_PARAM

Either the `rnnDesc` is `NULL` or `biasMode` has an invalid enumerant value.

CUDNN_STATUS_SUCCESS

The `biasMode` was set successfully.

CUDNN_STATUS_NOT_SUPPORTED

Non-default bias mode (an enumerated type besides `CUDNN_RNN_DOUBLE_BIAS`) applied to an RNN algo other than `CUDNN_RNN_ALGO_STANDARD`.

7.2.47. `cudaSetRNNDataDescriptor()`

```
cudaStatus_t cudaSetRNNDataDescriptor(
    cudaRNNDataDescriptor_t  RNNDataDesc,
    cudaDataType_t           dataType,
    cudaRNNDataLayout_t     layout,
    int                      maxSeqLength,
    int                      batchSize,
    int                      vectorSize,
    const int                seqLengthArray[],
    void                    *paddingFill);
```

This function initializes a previously created RNN data descriptor object. This data structure is intended to support the unpacked (padded) layout for input and output of extended RNN inference and training functions. A packed (unpadded) layout is also supported for backward compatibility.

Parameters

RNNDataDesc

Input/Output. A previously created RNN descriptor. For more information, see [cudaRNNDataDescriptor_t](#).

dataType

Input. The datatype of the RNN data tensor. For more information, see [cudaDataType_t](#).

layout

Input. The memory layout of the RNN data tensor.

maxSeqLength

Input. The maximum sequence length within this RNN data tensor. In the unpacked (padded) layout, this should include the padding vectors in each sequence. In the packed (unpadded) layout, this should be equal to the greatest element in `seqLengthArray`.

batchSize

Input. The number of sequences within the mini-batch.

vectorSize

Input. The vector length (embedding size) of the input or output tensor at each time-step.

seqLengthArray

Input. An integer array with `batchSize` number of elements. Describes the length (number of time-steps) of each sequence. Each element in `seqLengthArray` must be greater than or equal to 0 but less than or equal to `maxSeqLength`. In the packed layout, the elements should be sorted in descending order, similar to the layout required by the non-extended RNN compute functions.

paddingFill

Input. A user-defined symbol for filling the padding position in RNN output. This is only effective when the descriptor is describing the RNN output, and the unpacked layout is specified. The symbol should be in the host memory, and is interpreted as the same data type as that of the RNN data tensor. If a `NULL` pointer is passed in, then the padding position in the output will be undefined.

Returns

CUDNN_STATUS_SUCCESS

The object was set successfully.

CUDNN_STATUS_NOT_SUPPORTED

dataType is not one of CUDNN_DATA_HALF, CUDNN_DATA_FLOAT or CUDNN_DATA_DOUBLE.

CUDNN_STATUS_BAD_PARAM

Any one of these have occurred:

- ▶ RNNDataDesc is NULL.
- ▶ Any one of maxSeqLength, batchSize or vectorSize is less than or equal to zero.
- ▶ An element of seqLengthArray is less than zero or greater than maxSeqLength.
- ▶ Layout is not one of CUDNN_RNN_DATA_LAYOUT_SEQ_MAJOR_UNPACKED, CUDNN_RNN_DATA_LAYOUT_SEQ_MAJOR_PACKED or CUDNN_RNN_DATA_LAYOUT_BATCH_MAJOR_UNPACKED.

CUDNN_STATUS_ALLOC_FAILED

The allocation of internal array storage has failed.

7.2.48. cudnnSetRNNDescrptor_v6()

This function has been deprecated in cuDNN 8.0. Use [cudnnSetRNNDescrptor_v8\(\)](#) instead of cudnnSetRNNDescrptor_v6().

```

cudnnStatus_t cudnnSetRNNDescrptor_v6(
    cudnnHandle_t          handle,
    cudnnRNNDescrptor_t   rnnDesc,
    const int              hiddenSize,
    const int              numLayers,
    cudnnDropoutDescrptor_t dropoutDesc,
    cudnnRNNInputMode_t   inputMode,
    cudnnDirectionMode_t  direction,
    cudnnRNNMode_t        mode,
    cudnnRNNAlgo_t        algo,
    cudnnDataType_t       mathPrec)
    
```

This function initializes a previously created RNN descriptor object.



Note: Larger networks, for example, longer sequences or more layers, are expected to be more efficient than smaller networks.

Parameters

handle

Input. Handle to a previously created cuDNN library descriptor.

rnnDesc

Input/Output. A previously created RNN descriptor.

hiddenSize

Input. Size of the internal hidden state for each layer.

numLayers

Input. Number of stacked layers.

dropoutDesc

Input. Handle to a previously created and initialized dropout descriptor. Dropout will be applied between layers, for example, a single layer network will have no dropout applied.

inputMode

Input. Specifies the behavior at the input to the first layer

direction

Input. Specifies the recurrence pattern, for example, bidirectional.

mode

Input. Specifies the type of RNN to compute.

algo

Input. Specifies which RNN algorithm should be used to compute the results.

mathPrec

Input. Math precision. This parameter is used for controlling the math precision in RNN. The following applies:

- ▶ For the input/output in FP16, the parameter `mathPrec` can be `CUDNN_DATA_HALF` or `CUDNN_DATA_FLOAT`.
- ▶ For the input/output in FP32, the parameter `mathPrec` can only be `CUDNN_DATA_FLOAT`.
- ▶ For the input/output in FP64, double type, the parameter `mathPrec` can only be `CUDNN_DATA_DOUBLE`.

Returns

CUDNN_STATUS_SUCCESS

The object was set successfully.

CUDNN_STATUS_BAD_PARAM

Either at least one of the parameters `hiddenSize` or `numLayers` was zero or negative, one of `inputMode`, `direction`, `mode`, `algo` or `dataType` has an invalid enumerant value, `dropoutDesc` is an invalid dropout descriptor or `rnnDesc` has not been created correctly.

7.2.49. cudnnSetRNNDescrptor_v8()

```

cudnnStatus_t cudnnSetRNNDescrptor_v8(
    cudnnRNNDescrptor_t rnnDesc,
    cudnnRNNAlgo_t algo,
    cudnnRNNMode_t cellMode,
    cudnnRNNBiasMode_t biasMode,
    cudnnDirectionMode_t dirMode,
    cudnnRNNInputMode_t inputMode,
    cudnnDataType_t dataType,
    cudnnDataType_t mathPrec,
    cudnnMathType_t mathType,
    int32_t inputSize,
    int32_t hiddenSize,
    int32_t projSize,

```

```
int32_t numLayers,
  cudnnDropoutDescriptor_t dropoutDesc,
  uint32_t auxFlags);
```

This function initializes a previously created RNN descriptor object. The RNN descriptor configured by `cudnnSetRNNDescriptor_v8()` was enhanced to store all information needed to compute the total number of adjustable weights/biases in the RNN model.

Parameters

rnnDesc

Input. A previously initialized RNN descriptor.

algo

Input. RNN algo (CUDNN_RNN_ALGO_STANDARD, CUDNN_RNN_ALGO_PERSIST_STATIC, or CUDNN_RNN_ALGO_PERSIST_DYNAMIC).

cellMode

Input. Specifies the RNN cell type in the entire model (RELU, TANH, LSTM, GRU).

biasMode

Input. Sets the number of bias vectors (CUDNN_RNN_NO_BIAS, CUDNN_RNN_SINGLE_INP_BIAS, CUDNN_RNN_SINGLE_REC_BIAS, CUDNN_RNN_DOUBLE_BIAS). The two single bias settings are functionally the same for RELU, TANH and LSTM cell types. For differences in GRU cells, see the description of CUDNN_GRU in the [cudnnRNNMode_t](#) enumerated type.

dirMode

Input. Specifies the recurrence pattern: CUDNN_UNIDIRECTIONAL or CUDNN_BIDIRECTIONAL. In bidirectional RNNs, the hidden states passed between physical layers are concatenations of forward and backward hidden states.

inputMode

Input. Specifies how the input to the RNN model is processed by the first layer. When `inputMode` is CUDNN_LINEAR_INPUT, original input vectors of size `inputSize` are multiplied by the weight matrix to obtain vectors of `hiddenSize`. When `inputMode` is CUDNN_SKIP_INPUT, the original input vectors to the first layer are used as is without multiplying them by the weight matrix.

dataType

Input. Specifies data type for RNN weights/biases and input and output data.

mathPrec

Input. This parameter is used to control the compute math precision in the RNN model. The following applies:

- ▶ For the input/output in FP16, the parameter `mathPrec` can be CUDNN_DATA_HALF or CUDNN_DATA_FLOAT.
- ▶ For the input/output in FP32, the parameter `mathPrec` can only be CUDNN_DATA_FLOAT.

- ▶ For the input/output in FP64, double type, the parameter `mathPrec` can only be `CUDNN_DATA_DOUBLE`.

mathType

Input. Sets the preferred option to use NVIDIA Tensor Cores accelerators on Volta (SM 7.0) or higher GPU-s).

- ▶ When `dataType` is `CUDNN_DATA_HALF`, the `mathType` parameter can be `CUDNN_DEFAULT_MATH` or `CUDNN_TENSOR_OP_MATH`. The `ALLOW_CONVERSION` setting is treated the same `CUDNN_TENSOR_OP_MATH` for this data type.
- ▶ When `dataType` is `CUDNN_DATA_FLOAT`, the `mathType` parameter can be `CUDNN_DEFAULT_MATH` or `CUDNN_TENSOR_OP_MATH_ALLOW_CONVERSION`. When the latter settings are used, original weights and intermediate results will be down-converted to `CUDNN_DATA_HALF` before they are used in another recursive iteration.
- ▶ When `dataType` is `CUDNN_DATA_DOUBLE`, the `mathType` parameter can be `CUDNN_DEFAULT_MATH`.

This option has an advisory status meaning Tensor Cores may not be always utilized, for example, due to specific GEMM dimensions restrictions.

inputSize

Input. Size of the input vector in the RNN model. When the `inputMode=CUDNN_SKIP_INPUT`, the `inputSize` should match the `hiddenSize` value.

hiddenSize

Input. Size of the hidden state vector in the RNN model. The same hidden size is used in all RNN layers.

projSize

Input. The size of the LSTM cell output after the recurrent projection. This value should not be larger than `hiddenSize`. It is legal to set `projSize` equal to `hiddenSize`, however, in this case, the recurrent projection feature is disabled. The recurrent projection is an additional matrix multiplication in the LSTM cell to project hidden state vectors h_t into smaller vectors $r_t = \bar{w}_r h_t$, where \bar{w}_r is a rectangular matrix with `projSize` rows and `hiddenSize` columns. When the recurrent projection is enabled, the output of the LSTM cell (both to the next layer and unrolled in-time) is r_t instead of h_t . The recurrent projection can be enabled for LSTM cells and `CUDNN_RNN_ALGO_STANDARD` only.

numLayers

Input. Number of stacked, physical layers in the deep RNN model. When `dirMode=CUDNN_BIDIRECTIONAL`, the physical layer consists of two pseudo-layers corresponding to forward and backward directions.

dropoutDesc

Input. Handle to a previously created and initialized dropout descriptor. Dropout operation will be applied between physical layers. A single layer network will have no dropout applied. Dropout is used in the training mode only.

auxFlags

Input. This argument is used to pass miscellaneous switches that do not require additional numerical values to configure the corresponding feature. In future cuDNN releases, this parameter will be used to extend the RNN functionality without adding new API functions (applicable options should be bitwise OR-ed). Currently, this parameter is used to enable or disable padded input/output (CUDNN_RNN_PADDED_IO_DISABLED, CUDNN_RNN_PADDED_IO_ENABLED). When the padded I/O is enabled, layouts CUDNN_RNN_DATA_LAYOUT_SEQ_MAJOR_UNPACKED and CUDNN_RNN_DATA_LAYOUT_BATCH_MAJOR_UNPACKED are permitted in RNN data descriptors.

Returns

CUDNN_STATUS_SUCCESS

The RNN descriptor was configured successfully.

CUDNN_STATUS_BAD_PARAM

An invalid input argument was detected.

CUDNN_STATUS_NOT_SUPPORTED

The dimensions of the bias tensor refer to an amount of data that is incompatible with the output tensor dimensions or the `dataType` of the two tensor descriptors are different.

CUDNN_STATUS_EXECUTION_FAILED

An incompatible or unsupported combination of input arguments was detected.

7.2.50. cudnnSetRNNMatrixMathType()

This function has been deprecated in cuDNN 8.0. Use [cudnnSetRNNDescriptor_v8\(\)](#) instead of `cudnnSetRNNMatrixMathType()`.

```

cudnnStatus_t cudnnSetRNNMatrixMathType(
    cudnnRNNDescriptor_t    rnnDesc,
    cudnnMathType_t        mType)
    
```

This function sets the preferred option to use NVIDIA Tensor Cores accelerators on Volta GPUs (SM 7.0 or higher). When the `mType` parameter is `CUDNN_TENSOR_OP_MATH`, inference and training RNN APIs will attempt use Tensor Cores when weights/biases are of type `CUDNN_DATA_HALF` or `CUDNN_DATA_FLOAT`. When RNN weights/biases are stored in the `CUDNN_DATA_FLOAT` format, the original weights and intermediate results will be down-converted to `CUDNN_DATA_HALF` before they are used in another recursive iteration.

Parameters

rnnDesc

Input. A previously created and initialized RNN descriptor.

mType

Input. A preferred compute option when performing RNN GEMMs (general matrix-matrix multiplications). This option has an advisory status meaning that Tensor Cores may not be utilized, for example, due to specific GEMM dimensions.

Returns

CUDNN_STATUS_SUCCESS

The preferred compute option for the RNN network was set successfully.

CUDNN_STATUS_BAD_PARAM

An invalid input parameter was detected.

7.2.51. cudnnSetRNNPaddingMode ()

This function has been deprecated in cuDNN 8.0. Use [cudnnSetRNNDescriptor_v8\(\)](#) instead of `cudnnSetRNNPaddingMode ()`.

```

cudnnStatus_t cudnnSetRNNPaddingMode (
    cudnnRNNDescriptor_t      rnnDesc,
    cudnnRNNPaddingMode_t    paddingMode)
    
```

This function enables or disables the padded RNN input/output for a previously created and initialized RNN descriptor. This information is required before calling the [cudnnGetRNNWorkspaceSize\(\)](#) and [cudnnGetRNNTrainingReserveSize\(\)](#) functions, to determine whether additional workspace and training reserve space is needed. By default, the padded RNN input/output is not enabled.

Parameters

rnnDesc

Input/Output. A previously created RNN descriptor.

paddingMode

Input. Enables or disables the padded input/output. For more information, see [cudnnRNNPaddingMode_t](#).

Returns

CUDNN_STATUS_SUCCESS

The paddingMode was set successfully.

CUDNN_STATUS_BAD_PARAM

Either the `rnnDesc` is `NULL` or `paddingMode` has an invalid enumerant value.

7.2.52. cudnnSetRNNProjectionLayers()

This function has been deprecated in cuDNN 8.0. Use [cudnnSetRNNDescriptor_v8\(\)](#) instead of `cudnnSetRNNProjectionLayers()`.

```

cudnnStatus_t cudnnSetRNNProjectionLayers(
    cudnnHandle_t      handle,
    cudnnRNNDescriptor_t  rnnDesc,
    int                recProjSize,
    int                outProjSize)
    
```

The `cudnnSetRNNProjectionLayers()` function should be called to enable the recurrent and/or output projection in a recursive neural network. The recurrent projection is an additional matrix multiplication in the LSTM cell to project hidden state vectors h_t into smaller vectors $r_t = W_r h_t$, where W_r is a rectangular matrix with `recProjSize` rows and `hiddenSize` columns. When the recurrent projection is enabled, the output of the LSTM cell (both to the next layer and unrolled in-time) is r_t instead of h_t . The dimensionality of i_t , f_t , o_t , and c_t vectors used in conjunction with non-linear functions remains the same as in the canonical LSTM cell. To make this possible, the shapes of matrices in the LSTM formulas (see [cudnnRNNMode_t](#) type), such as W_i in hidden RNN layers or R_i in the entire network, become rectangular versus square in the canonical LSTM mode. Obviously, the result of $R_i * W_r$ is a square matrix but it is rank deficient, reflecting the compression of LSTM output. The recurrent projection is typically employed when the number of independent (adjustable) weights in the RNN network with projection is smaller in comparison to canonical LSTM for the same `hiddenSize` value.

The recurrent projection can be enabled for LSTM cells and `CUDNN_RNN_ALGO_STANDARD` only. The `recProjSize` parameter should be smaller than the `hiddenSize` value. It is legal to set `recProjSize` equal to `hiddenSize` but in that case the recurrent projection feature is disabled.

The output projection is currently not implemented.

For more information on the recurrent and output RNN projections, see the paper by [Hasim Sak, et al.: Long Short-Term Memory Based Recurrent Neural Network Architectures For Large Vocabulary Speech Recognition.](#)

Parameters

handle

Input. Handle to a previously created library descriptor.

rnnDesc

Input. A previously created and initialized RNN descriptor.

recProjSize

Input. The size of the LSTM cell output after the recurrent projection. This value should not be larger than `hiddenSize`.

outProjSize

Input. This parameter should be zero.

Returns

CUDNN_STATUS_SUCCESS

RNN projection parameters were set successfully.

CUDNN_STATUS_BAD_PARAM

An invalid input argument was detected (for example, NULL handles, negative values for projection parameters).

CUDNN_STATUS_NOT_SUPPORTED

Projection applied to RNN algo other than CUDNN_RNN_ALGO_STANDARD, cell type other than CUDNN_LSTM, recProjSize larger than hiddenSize.

7.2.53. cudnnSetSeqDataDescriptor()

```

cudnnStatus_t cudnnSetSeqDataDescriptor(
    cudnnSeqDataDescriptor_t seqDataDesc,
    cudnnDataType_t dataType,
    int nbDims,
    const int dimA[],
    const cudnnSeqDataAxis_t axes[],
    size_t seqLengthArraySize,
    const int seqLengthArray[],
    void *paddingFill);
    
```

This function initializes a previously created sequence data descriptor object. In the most simplified view, this descriptor defines dimensions (dimA) and the data layout (axes) of a four-dimensional tensor. All four dimensions of the sequence data descriptor have unique identifiers that can be used to index the dimA[] array:

```

CUDNN_SEQDATA_TIME_DIM
CUDNN_SEQDATA_BATCH_DIM
CUDNN_SEQDATA_BEAM_DIM
CUDNN_SEQDATA_VECT_DIM
    
```

For example, to express information that vectors in our sequence data buffer are five elements long, we need to assign dimA[CUDNN_SEQDATA_VECT_DIM]=5 in the dimA[] array.

The number of active dimensions in the dimA[] and axes[] arrays is defined by the nbDims argument. Currently, the value of this argument should be four. The actual size of the dimA[] and axes[] arrays should be declared using the CUDNN_SEQDATA_DIM_COUNT macro.

The [cudnnSeqDataDescriptor_t](#) container is treated as a collection of fixed length vectors that form sequences, similarly to words (vectors of characters) constructing sentences. The TIME dimension spans the sequence length. Different sequences are bundled together in a batch. A BATCH may be a group of individual sequences or beams. A BEAM is a cluster of alternative sequences or candidates. When thinking about the beam, consider a translation task from one language to another. You may want to keep around and experiment with several translated versions of the original sentence before selecting the best one. The number of candidates kept around is the BEAM size.

Every sequence can have a different length, even within the same beam, so vectors toward the end of the sequence can be just padding. The `paddingFill` argument specifies how the padding vectors should be written in output sequence data buffers. The `paddingFill` argument points to one value of type `dataType` that should be copied to all elements in padding vectors. Currently, the only supported value for `paddingFill` is `NULL` which means this option should be ignored. In this case, elements of the padding vectors in output buffers will have undefined values.

It is assumed that a non-empty sequence always starts from the time index zero. The `seqLengthArray[]` must specify all sequence lengths in the container so the total size of this array should be `dimA[CUDNN_SEQDATA_BATCH_DIM] * dimA[CUDNN_SEQDATA_BEAM_DIM]`. Each element of the `seqLengthArray[]` array should have a non-negative value, less than or equal to `dimA[CUDNN_SEQDATA_TIME_DIM]`; the maximum sequence length. Elements in `seqLengthArray[]` are always arranged in the same batch-major order, meaning, when considering `BEAM` and `BATCH` dimensions, `BATCH` is the outer or the slower changing index when we traverse the array in ascending order of the addresses. Using a simple example, the `seqLengthArray[]` array should hold sequence lengths in the following order:

```
{batch_idx=0, beam_idx=0}
{batch_idx=0, beam_idx=1}
{batch_idx=1, beam_idx=0}
{batch_idx=1, beam_idx=1}
{batch_idx=2, beam_idx=0}
{batch_idx=2, beam_idx=1}
```

when `dimA[CUDNN_SEQDATA_BATCH_DIM]=3` and `dimA[CUDNN_SEQDATA_BEAM_DIM]=2`.

Data stored in the `cudaSeqDataDescriptor_t` container must comply with the following constraints:

- ▶ All data is fully packed. There are no unused spaces or gaps between individual vector elements or consecutive vectors.
- ▶ The most inner dimension of the container is the vector. In other words, the first contiguous group of `dimA[CUDNN_SEQDATA_VECT_DIM]` elements belongs to the first vector, followed by elements of the second vector, and so on.

The `axes` argument in the `cudaSetSeqDataDescriptor()` function is a bit more complicated. This array should have the same capacity as `dimA[]`. The `axes[]` array specifies the actual data layout in the GPU memory. In this function, the layout is described in the following way: as we move from one element of a vector to another in memory by incrementing the element pointer, what is the order of `VECT`, `TIME`, `BATCH`, and `BEAM` dimensions that we encounter. Let us assume that we want to define the following data layout:

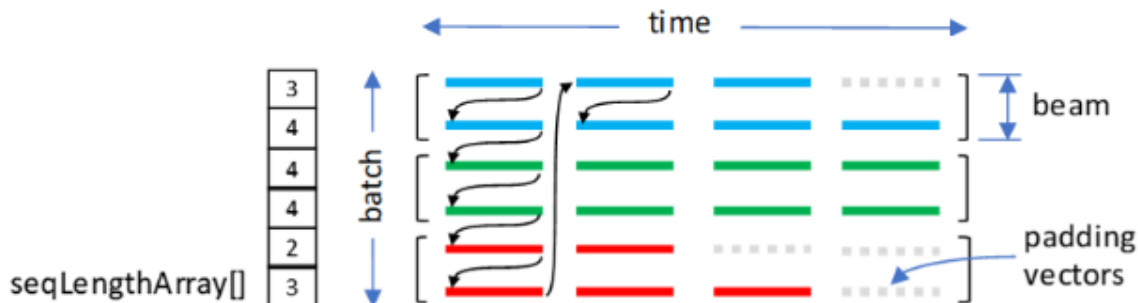

that corresponds to tensor dimensions:

```
int dimA[CUDNN_SEQDATA_DIM_COUNT];
```

```
dimA[CUDNN_SEQDATA_TIME_DIM] = 4;
dimA[CUDNN_SEQDATA_BATCH_DIM] = 3;
dimA[CUDNN_SEQDATA_BEAM_DIM] = 2;
dimA[CUDNN_SEQDATA_VECT_DIM] = 5;
```

Now, let's initialize the `axes []` array. Note that the most inner dimension is described by the last active element of `axes []`. There is only one valid configuration here as we always traverse a full vector first. Thus, we need to write `CUDNN_SEQDATA_VECT_DIM` in the last active element of `axes []`.

```
cudaSeqDataAxis_t axes[CUDNN_SEQDATA_DIM_COUNT];
axes[3] = CUDNN_SEQDATA_VECT_DIM; // 3 = nbDims-1
```

Now, let's work on the remaining three elements of `axes []`. When we reach the end of the first vector, we jump to the next beam, therefore:

```
axes[2] = CUDNN_SEQDATA_BEAM_DIM;
```

When we approach the end of the second vector, we move to the next batch, therefore:

```
axes[1] = CUDNN_SEQDATA_BATCH_DIM;
```

The last (outermost) dimension is `TIME`:

```
axes[0] = CUDNN_SEQDATA_TIME_DIM;
```

The four values of the `axes []` array fully describe the data layout depicted in the figure.

The sequence data descriptor allows the user to select $3! = 6$ different data layouts or permutations of `BEAM`, `BATCH` and `TIME` dimensions. The multi-head attention API supports all six layouts.

Parameters

seqDataDesc

Output. Pointer to a previously created sequence data descriptor.

dataType

Input. Data type of the sequence data buffer (`CUDNN_DATA_HALF`, `CUDNN_DATA_FLOAT` or `CUDNN_DATA_DOUBLE`).

nbDims

Input. Must be 4. The number of active dimensions in `dimA []` and `axes []` arrays. Both arrays should be declared to contain at least `CUDNN_SEQDATA_DIM_COUNT` elements.

dimA []

Input. Integer array specifying sequence data dimensions. Use the `cudaSeqDataAxis_t` enumerated type to index all active `dimA []` elements.

axes []

Input. Array of `cudaSeqDataAxis_t` that defines the layout of sequence data in memory. The first `nbDims` elements of `axes []` should be initialized with the outermost dimension in `axes [0]` and the innermost dimension in `axes [nbDims-1]`.

seqLengthArraySize

Input. Number of elements in the sequence length array, `seqLengthArray []`.

seqLengthArray []

Input. An integer array that defines all sequence lengths of the container.

paddingFill

Input. Must be `NULL`. Pointer to a value of `dataType` that is used to fill up output vectors beyond the valid length of each sequence or `NULL` to ignore this setting.

Returns**CUDNN_STATUS_SUCCESS**

All input arguments were validated and the sequence data descriptor was successfully updated.

CUDNN_STATUS_BAD_PARAM

An invalid input argument was found. Some examples include:

- ▶ `seqDataDesc=NULL`
- ▶ `dataType` was not a valid type of [cudnnDataType_t](#)
- ▶ `nbDims` was negative or zero
- ▶ `seqLengthArraySize` did not match the expected length
- ▶ some elements of `seqLengthArray[]` were invalid

CUDNN_STATUS_NOT_SUPPORTED

An unsupported input argument was encountered. Some examples include:

- ▶ `nbDims` is not equal to 4
- ▶ `paddingFill` is not `NULL`

CUDNN_STATUS_ALLOC_FAILED

Failed to allocate storage for the sequence data descriptor object.

Chapter 8. `cudaAdvTrain` Library

8.1. Data Type References

8.1.1. Enumeration Types

8.1.1.1. `cudaLossNormalizationMode_t`

`cudaLossNormalizationMode_t` is an enumerated type that controls the input normalization mode for a loss function. This type can be used with [`cudaSetCTCLossDescriptorEx\(\)`](#).

Values

`CUDNN_LOSS_NORMALIZATION_NONE`

The input `probs` of [`cudaCTCLoss\(\)`](#) function is expected to be the normalized probability, and the output `gradients` is the gradient of loss with respect to the unnormalized probability.

`CUDNN_LOSS_NORMALIZATION_SOFTMAX`

The input `probs` of [`cudaCTCLoss\(\)`](#) function is expected to be the unnormalized activation from the previous layer, and the output `gradients` is the gradient with respect to the activation. Internally the probability is computed by softmax normalization.

8.1.1.2. `cudaWgradMode_t`

`cudaWgradMode_t` is an enumerated type that selects how buffers holding gradients of the loss function, computed with respect to trainable parameters, are updated. Currently, this type is used by the [`cudaGetMultiHeadAttnWeights\(\)`](#) function only.

Values

CUDNN_WGRAD_MODE_ADD

A weight gradient component corresponding to a new batch of inputs is added to previously evaluated weight gradients. Before using this mode, the buffer holding weight gradients should be initialized to zero. Alternatively, the first API call outputting to an uninitialized buffer should use the `CUDNN_WGRAD_MODE_SET` option.

CUDNN_WGRAD_MODE_SET

A weight gradient component, corresponding to a new batch of inputs, overwrites previously stored weight gradients in the output buffer.

8.2. API Functions

8.2.1. **cudnnAdvTrainVersionCheck()**

```
cudnnStatus_t cudnnAdvTrainVersionCheck(void)
```

This function checks whether the version of the AdvTrain subset of the library is consistent with the other sub-libraries.

Returns

CUDNN_STATUS_SUCCESS

The version is consistent with other sub-libraries.

CUDNN_STATUS_VERSION_MISMATCH

The version of AdvTrain is not consistent with other sub-libraries. Users should check the installation and make sure all sub-component versions are consistent.

8.2.2. **cudnnCreateCTCLossDescriptor()**

```
cudnnStatus_t cudnnCreateCTCLossDescriptor(
    cudnnCTCLossDescriptor_t* ctcLossDesc)
```

This function creates a CTC loss function descriptor.

Parameters

ctcLossDesc

Output. CTC loss descriptor to be set. For more information, see [cudnnCTCLossDescriptor_t](#).

Returns

CUDNN_STATUS_SUCCESS

The function returned successfully.

CUDNN_STATUS_BAD_PARAM

CTC loss descriptor passed to the function is invalid.

CUDNN_STATUS_ALLOC_FAILED

Memory allocation for this CTC loss descriptor failed.

8.2.3. cudnnCTCLoss ()

```

cudnnStatus_t cudnnCTCLoss(
    cudnnHandle_t          handle,
    const cudnnTensorDescriptor_t  probsDesc,
    const void             *probs,
    const int              hostLabels[],
    const int              hostLabelLengths[],
    const int              hostInputLengths[],
    void                  *costs,
    const cudnnTensorDescriptor_t  gradientsDesc,
    const void             *gradients,
    cudnnCTCLossAlgo_t    algo,
    const cudnnCTCLossDescriptor_t  ctcLossDesc,
    void                  *workspace,
    size_t                 *workspaceSizeInBytes)
    
```

This function returns the CTC costs and gradients, given the probabilities and labels.

Note: This function can have an inconsistent interface depending on the `cudnnLossNormalizationMode_t` chosen (bound to the `cudnnCTCLossDescriptor_t` with `cudnnSetCTCLossDescriptorEx()`). For the `CUDNN_LOSS_NORMALIZATION_NONE`, this function has an inconsistent interface, for example, the probs input is probability normalized by softmax, but the gradients output is with respect to the unnormalized activation. However, for `CUDNN_LOSS_NORMALIZATION_SOFTMAX`, the function has a consistent interface; all values are normalized by softmax.

Parameters

handle

Input. Handle to a previously created cuDNN context. For more information, see [cudnnHandle_t](#).

probsDesc

Input. Handle to the previously initialized probabilities tensor descriptor. For more information, see [cudnnTensorDescriptor_t](#).

probs

Input. Pointer to a previously initialized probabilities tensor. These input probabilities are normalized by softmax.

hostLabels

Input. Pointer to a previously initialized labels list, in CPU memory.

hostLabelLengths

Input. Pointer to a previously initialized lengths list in CPU memory, to walk the above labels list.

hostInputLengths

Input. Pointer to a previously initialized list of the lengths of the timing steps in each batch, in CPU memory.

costs

Output. Pointer to the computed costs of CTC.

gradientsDesc

Input. Handle to a previously initialized gradient tensor descriptor.

gradients

Output. Pointer to the computed gradients of CTC. These computed gradient outputs are with respect to the unnormalized activation.

algo

Input. Enumerant that specifies the chosen CTC loss algorithm. For more information, see [cudaCTCLossAlgo_t](#).

ctcLossDesc

Input. Handle to the previously initialized CTC loss descriptor. For more information, see [cudaCTCLossDescriptor_t](#).

workspace

Input. Pointer to GPU memory of a workspace needed to be able to execute the specified algorithm.

sizeInBytes

Input. Amount of GPU memory needed as workspace to be able to execute the CTC loss computation with the specified `algo`.

Returns

CUDNN_STATUS_SUCCESS

The query was successful.

CUDNN_STATUS_BAD_PARAM

At least one of the following conditions are met:

- ▶ The dimensions of `probsDesc` do not match the dimensions of `gradientsDesc`.
- ▶ The `inputLengths` do not agree with the first dimension of `probsDesc`.

- ▶ The `workSpaceSizeInBytes` is not sufficient.
- ▶ The `labelLengths` is greater than 255.

CUDNN_STATUS_NOT_SUPPORTED

A compute or data type other than `FLOAT` was chosen, or an unknown algorithm type was chosen.

CUDNN_STATUS_EXECUTION_FAILED

The function failed to launch on the GPU.

8.2.4. `cudaCTCLoss_v8()`

```

cudaStatus_t cudaCTCLoss_v8(
    cudaHandle_t          handle,
    cudaCTCLossAlgo_t    algo,
    const cudaCTCLossDescriptor_t ctcLossDesc,
    const cudaTensorDescriptor_t probsDesc,
    const void            *probs,
    const int             labels[],
    const int             labelLengths[],
    const int             inputLengths[],
    void                 *costs,
    const cudaTensorDescriptor_t gradientsDesc,
    const void            *gradients,
    size_t               *workSpaceSizeInBytes,
    void                 *workspace)
    
```

This function returns the CTC costs and gradients, given the probabilities and labels. Many CTC API functions were updated in v8 with the `_v8` suffix to support CUDA graphs. Label and input data is now passed in GPU memory, and `cudaCTCLossDescriptor_t` should be set using `cudaSetCTCLossDescriptor_v8()`.

Note: This function can have an inconsistent interface depending on the `cudaLossNormalizationMode_t` chosen (bound to the `cudaCTCLossDescriptor_t` with `cudaSetCTCLossDescriptorEx()`). For the `CUDNN_LOSS_NORMALIZATION_NONE`, this function has an inconsistent interface, for example, the `probs` input is probability normalized by softmax, but the `gradients` output is with respect to the unnormalized activation. However, for `CUDNN_LOSS_NORMALIZATION_SOFTMAX`, the function has a consistent interface; all values are normalized by softmax.

Parameters

handle

Input. Handle to a previously created cuDNN context. For more information, see [cudaHandle_t](#).

algo

Input. Enumerant that specifies the chosen CTC loss algorithm. For more information, see [cudaCTCLossAlgo_t](#).

ctcLossDesc

Input. Handle to the previously initialized CTC loss descriptor. To use this `_v8` function, this descriptor must be set using [cudnnSetCTCLossDescriptor_v8\(\)](#). For more information, see [cudnnCTCLossDescriptor_t](#).

probsDesc

Input. Handle to the previously initialized probabilities tensor descriptor. For more information, see [cudnnTensorDescriptor_t](#).

probs

Input. Pointer to a previously initialized probabilities tensor. These input probabilities are normalized by softmax.

labels

Input. Pointer to a previously initialized labels list, in GPU memory.

labelLengths

Input. Pointer to a previously initialized lengths list in GPU memory, to walk the above labels list.

inputLengths

Input. Pointer to a previously initialized list of the lengths of the timing steps in each batch, in GPU memory.

costs

Output. Pointer to the computed costs of CTC.

gradientsDesc

Input. Handle to a previously initialized gradient tensor descriptor.

gradients

Output. Pointer to the computed gradients of CTC. These computed gradient outputs are with respect to the unnormalized activation.

workspace

Input. Pointer to GPU memory of a workspace needed to be able to execute the specified algorithm.

sizeInBytes

Input. Amount of GPU memory needed as a workspace to be able to execute the CTC loss computation with the specified `algo`.

Returns**CUDNN_STATUS_SUCCESS**

The query was successful.

CUDNN_STATUS_BAD_PARAM

At least one of the following conditions are met:

- ▶ The dimensions of `probsDesc` do not match the dimensions of `gradientsDesc`.
- ▶ The `inputLengths` do not agree with the first dimension of `probsDesc`.
- ▶ The `workSpaceSizeInBytes` is not sufficient.
- ▶ The `labelLengths` is greater than 256.

CUDNN_STATUS_NOT_SUPPORTED

A compute or data type other than `FLOAT` was chosen, or an unknown algorithm type was chosen.

CUDNN_STATUS_EXECUTION_FAILED

The function failed to launch on the GPU.

8.2.5. `cudaDestroyCTCLossDescriptor()`

```
cudaStatus_t cudaDestroyCTCLossDescriptor(
    cudaCTCLossDescriptor_t ctcLossDesc)
```

This function destroys a CTC loss function descriptor object.

Parameters

ctcLossDesc

Input. CTC loss function descriptor to be destroyed.

Returns

CUDNN_STATUS_SUCCESS

The function returned successfully.

8.2.6. `cudaFindRNNBackwardDataAlgorithmEx()`

This function has been deprecated in cuDNN 8.0.

```
cudaStatus_t cudaFindRNNBackwardDataAlgorithmEx(
    cudaHandle_t          handle,
    const cudaRNNDescriptor_t  rnnDesc,
    const int             seqLength,
    const cudaTensorDescriptor_t *yDesc,
    const void            *y,
    const cudaTensorDescriptor_t *dyDesc,
    const void            *dy,
    const cudaTensorDescriptor_t dhyDesc,
    const void            *dhy,
    const cudaTensorDescriptor_t dcyDesc,
    const void            *dcy,
    const cudaFilterDescriptor_t wDesc,
    const void            *w,
    const cudaTensorDescriptor_t hxDesc,
    const void            *hx,
```

```

const cudnnTensorDescriptor_t    cxDesc,
const void                       *cx,
const cudnnTensorDescriptor_t    dxDesc,
void                             *dx,
const cudnnTensorDescriptor_t    dhxDesc,
void                             *dhx,
const cudnnTensorDescriptor_t    dcxDesc,
void                             *dcx,
const float                      findIntensity,
const int                        requestedAlgoCount,
int                              *returnedAlgoCount,
cudnnAlgorithmPerformance_t      *perfResults,
void                             *workspace,
size_t                           workSpaceSizeInBytes,
const void                       *reserveSpace,
size_t                           reserveSpaceSizeInBytes)

```

This function attempts all available cuDNN algorithms for [cudnnRNNBackwardData\(\)](#), using user-allocated GPU memory. It outputs the parameters that influence the performance of the algorithm to a user-allocated array of `cudnnAlgorithmPerformance_t`. These parameter metrics are written in sorted fashion where the first element has the lowest compute time.

Parameters

handle

Input. Handle to a previously created cuDNN context.

rnnDesc

Input. A previously initialized RNN descriptor.

seqLength

Input. Number of iterations to unroll over. The value of this `seqLength` must not exceed the value that was used in [cudnnGetRNNWorkspaceSize\(\)](#) function for querying the workspace size required to execute the RNN.

yDesc

Input. An array of fully packed tensor descriptors describing the output from each recurrent iteration (one descriptor per iteration). The second dimension of the tensor depends on the direction argument used to initialize `rnnDesc`:

- ▶ If `direction` is `CUDNN_UNIDIRECTIONAL` the second dimension should match the `hiddenSize` argument.
- ▶ If `direction` is `CUDNN_BIDIRECTIONAL` the second dimension should match double the `hiddenSize` argument.

The first dimension of the tensor `n` must match the first dimension of the tensor `n` in `dyDesc`.

y

Input. Data pointer to GPU memory associated with the output tensor descriptor `yDesc`.

dyDesc

Input. An array of fully packed tensor descriptors describing the gradient at the output from each recurrent iteration (one descriptor per iteration). The second dimension of the tensor depends on the `direction` argument used to initialize `rnnDesc`:

- ▶ If `direction` is `CUDNN_UNIDIRECTIONAL` the second dimension should match the `hiddenSize` argument.
- ▶ If `direction` is `CUDNN_BIDIRECTIONAL` the second dimension should match double the `hiddenSize` argument.

The first dimension of the tensor `n` must match the second dimension of the tensor `n` in `dxDesc`.

dy

Input. Data pointer to GPU memory associated with the tensor descriptors in the array `dyDesc`.

dhyDesc

Input. A fully packed tensor descriptor describing the gradients at the final hidden state of the RNN. The first dimension of the tensor depends on the `direction` argument used to initialize `rnnDesc`:

- ▶ If `direction` is `CUDNN_UNIDIRECTIONAL` the first dimension should match the `numLayers` argument.
- ▶ If `direction` is `CUDNN_BIDIRECTIONAL` the first dimension should match double the `numLayers` argument.

The second dimension must match the first dimension of the tensors described in `dxDesc`. The third dimension must match the `hiddenSize` argument used to initialize `rnnDesc`. The tensor must be fully packed.

dhy

Input. Data pointer to GPU memory associated with the tensor descriptor `dhyDesc`. If a `NULL` pointer is passed, the gradients at the final hidden state of the network will be initialized to zero.

dcyDesc

Input. A fully packed tensor descriptor describing the gradients at the final cell state of the RNN. The first dimension of the tensor depends on the `direction` argument used to initialize `rnnDesc`:

- ▶ If `direction` is `CUDNN_UNIDIRECTIONAL` the first dimension should match the `numLayers` argument.
- ▶ If `direction` is `CUDNN_BIDIRECTIONAL` the first dimension should match double the `numLayers` argument.

The second dimension must match the first dimension of the tensors described in `dxDesc`. The third dimension must match the `hiddenSize` argument used to initialize `rnnDesc`. The tensor must be fully packed.

dcy

Input. Data pointer to GPU memory associated with the tensor descriptor `dcyDesc`. If a `NULL` pointer is passed, the gradients at the final cell state of the network will be initialized to zero.

wDesc

Input. Handle to a previously initialized filter descriptor describing the weights for the RNN.

w

Input. Data pointer to GPU memory associated with the filter descriptor `wDesc`.

hxDesc

Input. A fully packed tensor descriptor describing the initial hidden state of the RNN. The first dimension of the tensor depends on the `direction` argument used to initialize `rnnDesc`:

- ▶ If `direction` is `CUDNN_UNIDIRECTIONAL` the first dimension should match the `numLayers` argument.
- ▶ If `direction` is `CUDNN_BIDIRECTIONAL` the first dimension should match double the `numLayers` argument.

The second dimension must match the first dimension of the tensors described in `dxDesc`. The third dimension must match the `hiddenSize` argument used to initialize `rnnDesc`. The tensor must be fully packed.

hx

Input. Data pointer to GPU memory associated with the tensor descriptor `hxDesc`. If a `NULL` pointer is passed, the initial hidden state of the network will be initialized to zero.

cxDesc

Input. A fully packed tensor descriptor describing the initial cell state for LSTM networks. The first dimension of the tensor depends on the `direction` argument used to initialize `rnnDesc`:

- ▶ If `direction` is `CUDNN_UNIDIRECTIONAL` the first dimension should match the `numLayers` argument.
- ▶ If `direction` is `CUDNN_BIDIRECTIONAL` the first dimension should match double the `numLayers` argument.

The second dimension must match the first dimension of the tensors described in `dxDesc`. The third dimension must match the `hiddenSize` argument used to initialize `rnnDesc`. The tensor must be fully packed.

cx

Input. Data pointer to GPU memory associated with the tensor descriptor `cxDesc`. If a `NULL` pointer is passed, the initial cell state of the network will be initialized to zero.

dxDesc

Input. An array of fully packed tensor descriptors describing the gradient at the input of each recurrent iteration (one descriptor per iteration). The first dimension (batch size) of the tensors may decrease from element `n` to element `n+1` but may not increase. Each tensor descriptor must have the same second dimension (vector length).

dx

Output. Data pointer to GPU memory associated with the tensor descriptors in the array `dxDesc`.

dhxDesc

Input. A fully packed tensor descriptor describing the gradient at the initial hidden state of the RNN. The first dimension of the tensor depends on the `direction` argument used to initialize `rnnDesc`:

- ▶ If `direction` is `CUDNN_UNIDIRECTIONAL` the first dimension should match the `numLayers` argument.
- ▶ If `direction` is `CUDNN_BIDIRECTIONAL` the first dimension should match double the `numLayers` argument.

The second dimension must match the first dimension of the tensors described in `dxDesc`. The third dimension must match the `hiddenSize` argument used to initialize `rnnDesc`. The tensor must be fully packed.

dhx

Output. Data pointer to GPU memory associated with the tensor descriptor `dhxDesc`. If a `NULL` pointer is passed, the gradient at the hidden input of the network will not be set.

dcxDesc

Input. A fully packed tensor descriptor describing the gradient at the initial cell state of the RNN. The first dimension of the tensor depends on the `direction` argument used to initialize `rnnDesc`:

- ▶ If `direction` is `CUDNN_UNIDIRECTIONAL` the first dimension should match the `numLayers` argument.
- ▶ If `direction` is `CUDNN_BIDIRECTIONAL` the first dimension should match double the `numLayers` argument.

The second dimension must match the first dimension of the tensors described in `dxDesc`. The third dimension must match the `hiddenSize` argument used to initialize `rnnDesc`. The tensor must be fully packed.

dcx

Output. Data pointer to GPU memory associated with the tensor descriptor `dcxDesc`. If a `NULL` pointer is passed, the gradient at the cell input of the network will not be set.

findIntensity

Input. This input was previously unused in versions prior to cuDNN 7.2.0. It is used in cuDNN 7.2.0 and later versions to control the overall runtime of the RNN find algorithms, by selecting the percentage of a large Cartesian product space to be searched.

- ▶ Setting `findIntensity` within the range $(0, 1.]$ will set a percentage of the entire RNN search space to search. When `findIntensity` is set to 1.0, a full search is performed over all RNN parameters.
- ▶ When `findIntensity` is set to 0.0f, a quick, minimal search is performed. This setting has the best runtime. However, in this case the parameters returned by this function will not correspond to the best performance of the algorithm; a longer search might discover better parameters. This option will execute up to three instances of the configured RNN problem. Runtime will vary proportionally to RNN problem size, as it will in the other cases, hence no guarantee of an explicit time bound can be given.
- ▶ Setting `findIntensity` within the range $[-1., 0]$ sets a percentage of a reduced Cartesian product space to be searched. This reduced search space has been heuristically selected to have good performance. The setting of -1.0 represents a full search over this reduced search space.
- ▶ Values outside the range $[-1, 1]$ are truncated to the range $[-1, 1]$, and then interpreted as per the above.
- ▶ Setting `findIntensity` to 1.0 in cuDNN 7.2 and later versions is equivalent to the behavior of this function in versions prior to cuDNN 7.2.0.
- ▶ This function times the single RNN executions over large parameter spaces - one execution per parameter combination. The times returned by this function are latencies.

requestedAlgoCount

Input. The maximum number of elements to be stored in `perfResults`.

returnedAlgoCount

Output. The number of output elements stored in `perfResults`.

perfResults

Output. A user-allocated array to store performance metrics sorted ascending by compute time.

workspace

Input. Data pointer to GPU memory to be used as a workspace for this call.

workspaceSizeInBytes

Input. Specifies the size in bytes of the provided `workspace`.

reserveSpace

Input/Output. Data pointer to GPU memory to be used as a reserve space for this call.

reserveSpaceSizeInBytes

Input. Specifies the size in bytes of the provided `reserveSpace`.

Returns

CUDNN_STATUS_SUCCESS

The function launched successfully.

CUDNN_STATUS_NOT_SUPPORTED

The function does not support the provided configuration.

CUDNN_STATUS_BAD_PARAM

At least one of the following conditions are met:

- ▶ The descriptor `rnnDesc` is invalid.
- ▶ At least one of the descriptors `dhxDesc`, `wDesc`, `hxDesc`, `cxDesc`, `dcxDesc`, `dhyDesc`, `dcyDesc` or one of the descriptors in `yDesc`, `dxDesc`, `dyDesc` is invalid.
- ▶ The descriptors in one of `yDesc`, `dxDesc`, `dyDesc`, `dhxDesc`, `wDesc`, `hxDesc`, `cxDesc`, `dcxDesc`, `dhyDesc`, `dcyDesc` has incorrect strides or dimensions.
- ▶ `workSpaceSizeInBytes` is too small.
- ▶ `reserveSpaceSizeInBytes` is too small.

CUDNN_STATUS_EXECUTION_FAILED

The function failed to launch on the GPU.

CUDNN_STATUS_ALLOC_FAILED

The function was unable to allocate memory.

8.2.7. cudnnFindRNNBackwardWeightsAlgorithmEx()

This function has been deprecated in cuDNN 8.0.

```

cudnnStatus_t cudnnFindRNNBackwardWeightsAlgorithmEx(
    cudnnHandle_t          handle,
    const cudnnRNNDescriptor_t  rnnDesc,
    const int              seqLength,
    const cudnnTensorDescriptor_t *xDesc,
    const void             *x,
    const cudnnTensorDescriptor_t hxDesc,
    const void             *hx,
    const cudnnTensorDescriptor_t *yDesc,
    const void             *y,
    const float            findIntensity,
    const int              requestedAlgoCount,
    int                    *returnedAlgoCount,
    cudnnAlgorithmPerformance_t *perfResults,
    const void             *workspace,
    size_t                 workspaceSizeInBytes,

```

```

const cudnnFilterDescriptor_t    dwDesc,
void                             *dw,
const void                       *reserveSpace,
size_t                           reserveSpaceSizeInBytes)

```

This function attempts all available cuDNN algorithms for [cudnnRNNBackwardWeights\(\)](#), using user-allocated GPU memory. It outputs the parameters that influence the performance of the algorithm to a user-allocated array of `cudnnAlgorithmPerformance_t`. These parameter metrics are written in sorted fashion where the first element has the lowest compute time.

Parameters

handle

Input. Handle to a previously created cuDNN context.

rnnDesc

Input. A previously initialized RNN descriptor.

seqLength

Input. Number of iterations to unroll over. The value of this `seqLength` must not exceed the value that was used in [cudnnGetRNNWorkspaceSize\(\)](#) function for querying the workspace size required to execute the RNN.

xDesc

Input. An array of fully packed tensor descriptors describing the input to each recurrent iteration (one descriptor per iteration). The first dimension (batch size) of the tensors may decrease from element `n` to element `n+1` but may not increase. Each tensor descriptor must have the same second dimension (vector length).

x

Input. Data pointer to GPU memory associated with the tensor descriptors in the array `xDesc`.

hxDesc

Input. A fully packed tensor descriptor describing the initial hidden state of the RNN. The first dimension of the tensor depends on the `direction` argument used to initialize `rnnDesc`:

- ▶ If `direction` is `CUDNN_UNIDIRECTIONAL` the first dimension should match the `numLayers` argument.
- ▶ If `direction` is `CUDNN_BIDIRECTIONAL` the first dimension should match double the `numLayers` argument.

The second dimension must match the first dimension of the tensors described in `xDesc`. The third dimension must match the `hiddenSize` argument used to initialize `rnnDesc`. The tensor must be fully packed.

hx

Input. Data pointer to GPU memory associated with the tensor descriptor `hxDesc`. If a `NULL` pointer is passed, the initial hidden state of the network will be initialized to zero.

yDesc

Input. An array of fully packed tensor descriptors describing the output from each recurrent iteration (one descriptor per iteration). The second dimension of the tensor depends on the `direction` argument used to initialize `rnnDesc`:

- ▶ If `direction` is `CUDNN_UNIDIRECTIONAL` the second dimension should match the `hiddenSize` argument.
- ▶ If `direction` is `CUDNN_BIDIRECTIONAL` the second dimension should match double the `hiddenSize` argument.

The first dimension of the tensor `n` must match the first dimension of the tensor `n` in `dyDesc`.

y

Input. Data pointer to GPU memory associated with the output tensor descriptor `yDesc`.

findIntensity

Input. This input was previously unused in versions prior to cuDNN 7.2.0. It is used in cuDNN 7.2.0 and later versions to control the overall runtime of the RNN find algorithms, by selecting the percentage of a large Cartesian product space to be searched.

- ▶ Setting `findIntensity` within the range `[0,1.]` will set a percentage of the entire RNN search space to search. When `findIntensity` is set to `1.0`, a full search is performed over all RNN parameters.
- ▶ When `findIntensity` is set to `0.0f`, a quick, minimal search is performed. This setting has the best runtime. However, in this case the parameters returned by this function will not correspond to the best performance of the algorithm; a longer search might discover better parameters. This option will execute up to three instances of the configured RNN problem. Runtime will vary proportionally to RNN problem size, as it will in the other cases, hence no guarantee of an explicit time bound can be given.
- ▶ Setting `findIntensity` within the range `[-1.,0]` sets a percentage of a reduced Cartesian product space to be searched. This reduced search space has been heuristically selected to have good performance. The setting of `-1.0` represents a full search over this reduced search space.
- ▶ Values outside the range `[-1,1]` are truncated to the range `[-1,1]`, and then interpreted as per the above.
- ▶ Setting `findIntensity` to `1.0` in cuDNN 7.2 and later versions is equivalent to the behavior of this function in versions prior to cuDNN 7.2.0.
- ▶ This function times the single RNN executions over large parameter spaces - one execution per parameter combination. The times returned by this function are latencies.

requestedAlgoCount

Input. The maximum number of elements to be stored in `perfResults`.

returnedAlgoCount

Output. The number of output elements stored in `perfResults`.

perfResults

Output. A user-allocated array to store performance metrics sorted ascending by compute time.

workspace

Input. Data pointer to GPU memory to be used as a workspace for this call.

workspaceSizeInBytes

Input. Specifies the size in bytes of the provided `workspace`.

dwDesc

Input. Handle to a previously initialized filter descriptor describing the gradients of the weights for the RNN.

dw

Input/Output. Data pointer to GPU memory associated with the filter descriptor `dwDesc`.

reserveSpace

Input. Data pointer to GPU memory to be used as a reserve space for this call.

reserveSpaceSizeInBytes

Input. Specifies the size in bytes of the provided `reserveSpace`.

Returns**CUDNN_STATUS_SUCCESS**

The function launched successfully.

CUDNN_STATUS_NOT_SUPPORTED

The function does not support the provided configuration.

CUDNN_STATUS_BAD_PARAM

At least one of the following conditions are met:

- ▶ The descriptor `rnnDesc` is invalid.
- ▶ At least one of the descriptors `hxDesc`, `dwDesc` or one of the descriptors in `xDesc`, `yDesc` is invalid.
- ▶ The descriptors in one of `xDesc`, `hxDesc`, `yDesc`, `dwDesc` have incorrect strides or dimensions.
- ▶ `workspaceSizeInBytes` is too small.
- ▶ `reserveSpaceSizeInBytes` is too small.

CUDNN_STATUS_EXECUTION_FAILED

The function failed to launch on the GPU.

CUDNN_STATUS_ALLOC_FAILED

The function was unable to allocate memory.

8.2.8. cudnnFindRNNForwardTrainingAlgorithmEx()

This function has been deprecated in cuDNN 8.0.

```

cudaStatus_t cudnnFindRNNForwardTrainingAlgorithmEx(
    cudaHandle_t          handle,
    const cudnnRNNDescriptor_t  rnnDesc,
    const int             seqLength,
    const cudnnTensorDescriptor_t *xDesc,
    const void           *x,
    const cudnnTensorDescriptor_t  hxDesc,
    const void           *hx,
    const cudnnTensorDescriptor_t  cxDesc,
    const void           *cx,
    const cudnnFilterDescriptor_t  wDesc,
    const void           *w,
    const cudnnTensorDescriptor_t  yDesc,
    void                *y,
    const cudnnTensorDescriptor_t  hyDesc,
    void                *hy,
    const cudnnTensorDescriptor_t  cyDesc,
    void                *cy,
    const float          findIntensity,
    const int            requestedAlgoCount,
    int                  *returnedAlgoCount,
    cudnnAlgorithmPerformance_t *perfResults,
    void                *workspace,
    size_t               workspaceSizeInBytes,
    void                *reserveSpace,
    size_t               reserveSpaceSizeInBytes)

```

This function attempts all available cuDNN algorithms for [cudnnRNNForwardTraining\(\)](#), using user-allocated GPU memory. It outputs the parameters that influence the performance of the algorithm to a user-allocated array of `cudnnAlgorithmPerformance_t`. These parameter metrics are written in sorted fashion where the first element has the lowest compute time.

Parameters

handle

Input. Handle to a previously created cuDNN context.

rnnDesc

Input. A previously initialized RNN descriptor.

xDesc

Input. An array of fully packed tensor descriptors describing the input to each recurrent iteration (one descriptor per iteration). The first dimension (batch size) of the tensors may decrease from element *n* to element *n+1* but may not increase. Each tensor descriptor must have the same second dimension (vector length).

seqLength

Input. Number of iterations to unroll over. The value of this `seqLength` must not exceed the value that was used in `cudaGetRNNWorkspaceSize()` function for querying the workspace size required to execute the RNN.

x

Input. Data pointer to GPU memory associated with the tensor descriptors in the array `xDesc`.

hxDesc

Input. A fully packed tensor descriptor describing the initial hidden state of the RNN. The first dimension of the tensor depends on the `direction` argument used to initialize `rnnDesc`:

- ▶ If `direction` is `CUDNN_UNIDIRECTIONAL` the first dimension should match the `numLayers` argument.
- ▶ If `direction` is `CUDNN_BIDIRECTIONAL` the first dimension should match double the `numLayers` argument.

The second dimension must match the first dimension of the tensors described in `xDesc`. The third dimension must match the `hiddenSize` argument used to initialize `rnnDesc`. The tensor must be fully packed.

hx

Input. Data pointer to GPU memory associated with the tensor descriptor `hxDesc`. If a `NULL` pointer is passed, the initial hidden state of the network will be initialized to zero.

cxDesc

Input. A fully packed tensor descriptor describing the initial cell state for LSTM networks. The first dimension of the tensor depends on the `direction` argument used to initialize `rnnDesc`:

- ▶ If `direction` is `CUDNN_UNIDIRECTIONAL` the first dimension should match the `numLayers` argument.
- ▶ If `direction` is `CUDNN_BIDIRECTIONAL` the first dimension should match double the `numLayers` argument.

The second dimension must match the first dimension of the tensors described in `xDesc`. The third dimension must match the `hiddenSize` argument used to initialize `rnnDesc`. The tensor must be fully packed.

cx

Input. Data pointer to GPU memory associated with the tensor descriptor `cxDesc`. If a `NULL` pointer is passed, the initial cell state of the network will be initialized to zero.

wDesc

Input. Handle to a previously initialized filter descriptor describing the weights for the RNN.

w

Input. Data pointer to GPU memory associated with the filter descriptor `wDesc`.

yDesc

Input. An array of fully packed tensor descriptors describing the output from each recurrent iteration (one descriptor per iteration). The second dimension of the tensor depends on the `direction` argument used to initialize `rnnDesc`:

- ▶ If `direction` is `CUDNN_UNIDIRECTIONAL` the second dimension should match the `hiddenSize` argument.
- ▶ If `direction` is `CUDNN_BIDIRECTIONAL` the second dimension should match double the `hiddenSize` argument.

The first dimension of the tensor `n` must match the first dimension of the tensor `n` in `xDesc`.

y

Output. Data pointer to GPU memory associated with the output tensor descriptor `yDesc`.

hyDesc

Input. A fully packed tensor descriptor describing the final hidden state of the RNN. The first dimension of the tensor depends on the `direction` argument used to initialize `rnnDesc`:

- ▶ If `direction` is `CUDNN_UNIDIRECTIONAL` the first dimension should match the `numLayers` argument.
- ▶ If `direction` is `CUDNN_BIDIRECTIONAL` the first dimension should match double the `numLayers` argument.

The second dimension must match the first dimension of the tensors described in `xDesc`. The third dimension must match the `hiddenSize` argument used to initialize `rnnDesc`. The tensor must be fully packed.

hy

Output. Data pointer to GPU memory associated with the tensor descriptor `hyDesc`. If a `NULL` pointer is passed, the final hidden state of the network will not be saved.

cyDesc

Input. A fully packed tensor descriptor describing the final cell state for LSTM networks. The first dimension of the tensor depends on the `direction` argument used to initialize `rnnDesc`:

- ▶ If `direction` is `CUDNN_UNIDIRECTIONAL` the first dimension should match the `numLayers` argument.
- ▶ If `direction` is `CUDNN_BIDIRECTIONAL` the first dimension should match double the `numLayers` argument.

The second dimension must match the first dimension of the tensors described in `xDesc`. The third dimension must match the `hiddenSize` argument used to initialize `rnnDesc`. The tensor must be fully packed.

cy

Output. Data pointer to GPU memory associated with the tensor descriptor `cyDesc`. If a `NULL` pointer is passed, the final cell state of the network will not be saved.

findIntensity

Input. This input was previously unused in versions prior to cuDNN 7.2.0. It is used in cuDNN 7.2.0 and later versions to control the overall runtime of the RNN find algorithms, by selecting the percentage of a large Cartesian product space to be searched.

- ▶ Setting `findIntensity` within the range $(0,1]$ will set a percentage of the entire RNN search space to search. When `findIntensity` is set to 1.0, a full search is performed over all RNN parameters.
- ▶ When `findIntensity` is set to 0.0f, a quick, minimal search is performed. This setting has the best runtime. However, in this case the parameters returned by this function will not correspond to the best performance of the algorithm; a longer search might discover better parameters. This option will execute up to three instances of the configured RNN problem. Runtime will vary proportionally to RNN problem size, as it will in the other cases, hence no guarantee of an explicit time bound can be given.
- ▶ Setting `findIntensity` within the range $[-1.,0]$ sets a percentage of a reduced Cartesian product space to be searched. This reduced search space has been heuristically selected to have good performance. The setting of -1.0 represents a full search over this reduced search space.
- ▶ Values outside the range $[-1,1]$ are truncated to the range $[-1,1]$, and then interpreted as per the above.
- ▶ Setting `findIntensity` to 1.0 in cuDNN 7.2 and later versions is equivalent to the behavior of this function in versions prior to cuDNN 7.2.0.
- ▶ This function times the single RNN executions over large parameter spaces - one execution per parameter combination. The times returned by this function are latencies.

requestedAlgoCount

Input. The maximum number of elements to be stored in `perfResults`.

returnedAlgoCount

Output. The number of output elements stored in `perfResults`.

perfResults

Output. A user-allocated array to store performance metrics sorted ascending by compute time.

workspace

Input. Data pointer to GPU memory to be used as a workspace for this call.

workspaceSizeInBytes

Input. Specifies the size in bytes of the provided workspace.

reserveSpace

Input/Output. Data pointer to GPU memory to be used as a reserve space for this call.

reserveSpaceSizeInBytes

Input. Specifies the size in bytes of the provided reserveSpace.

Returns

CUDNN_STATUS_SUCCESS

The function launched successfully.

CUDNN_STATUS_BAD_PARAM

At least one of the following conditions are met:

- ▶ The descriptor rnnDesc is invalid.
- ▶ At least one of the descriptors hxDesc, cxDesc, wDesc, hyDesc, cyDesc or one of the descriptors in xDesc, yDesc is invalid.
- ▶ The descriptors in one of xDesc, hxDesc, cxDesc, wDesc, yDesc, hyDesc, cyDesc have incorrect strides or dimensions.
- ▶ workspaceSizeInBytes is too small.
- ▶ reserveSpaceSizeInBytes is too small.

CUDNN_STATUS_EXECUTION_FAILED

The function failed to launch on the GPU.

CUDNN_STATUS_ALLOC_FAILED

The function was unable to allocate memory.

8.2.9. **cudaGetCTCLossDescriptor()**

```
cudaStatus_t cudaGetCTCLossDescriptor(
    cudaCTCLossDescriptor_t      ctcLossDesc,
    cudaDataType_t*              compType)
```

This function returns the configuration of the passed CTC loss function descriptor.

Parameters

ctcLossDesc

Input. CTC loss function descriptor passed, from which to retrieve the configuration.

compType

Output. Compute type associated with this CTC loss function descriptor.

Returns

CUDNN_STATUS_SUCCESS

The function returned successfully.

CUDNN_STATUS_BAD_PARAM

Input `OpTensor` descriptor passed is invalid.

8.2.10. cudnnGetCTCLossDescriptorEx()

```

cudnnStatus_t cudnnGetCTCLossDescriptorEx(
    cudnnCTCLossDescriptor_t      ctcLossDesc,
    cudnnDataType_t               *compType,
    cudnnLossNormalizationMode_t *normMode,
    cudnnNanPropagation_t         *gradMode)

```

This function returns the configuration of the passed CTC loss function descriptor.

Parameters

ctcLossDesc

Input. CTC loss function descriptor passed, from which to retrieve the configuration.

compType

Output. Compute type associated with this CTC loss function descriptor.

normMode

Output. Input normalization type for this CTC loss function descriptor. For more information, see [cudnnLossNormalizationMode_t](#).

gradMode

Output. NaN propagation type for this CTC loss function descriptor.

Returns

CUDNN_STATUS_SUCCESS

The function returned successfully.

CUDNN_STATUS_BAD_PARAM

Input `OpTensor` descriptor passed is invalid.

8.2.11. cudnnGetCTCLossDescriptor_v8()

```

cudnnStatus_t cudnnGetCTCLossDescriptor_v8(
    cudnnCTCLossDescriptor_t      ctcLossDesc,
    cudnnDataType_t               *compType,
    cudnnLossNormalizationMode_t *normMode,
    cudnnNanPropagation_t         *gradMode,
    int                            *maxLabelLength)

```

This function returns the configuration of the passed CTC loss function descriptor.

Parameters

ctcLossDesc

Input. CTC loss function descriptor passed, from which to retrieve the configuration.

compType

Output. Compute type associated with this CTC loss function descriptor.

normMode

Output. Input normalization type for this CTC loss function descriptor. For more information, see [cudnnLossNormalizationMode_t](#).

gradMode

Output. NaN propagation type for this CTC loss function descriptor.

maxLabelLength

Output. The max label length for this CTC loss function descriptor.

Returns

CUDNN_STATUS_SUCCESS

The function returned successfully.

CUDNN_STATUS_BAD_PARAM

Input `OpTensor` descriptor passed is invalid.

8.2.12. cudnnGetCTCLossWorkspaceSize()

```

cudnnStatus_t cudnnGetCTCLossWorkspaceSize(
    cudnnHandle_t          handle,
    const cudnnTensorDescriptor_t  probsDesc,
    const cudnnTensorDescriptor_t  gradientsDesc,
    const int              *labels,
    const int              *labelLengths,
    const int              *inputLengths,
    cudnnCTCLossAlgo_t     algo,
    const cudnnCTCLossDescriptor_t  ctcLossDesc,
    size_t                 *sizeInBytes)
    
```

This function returns the amount of GPU memory workspace the user needs to allocate to be able to call [cudnnCTCLoss\(\)](#) with the specified algorithm. The workspace allocated will then be passed to the routine [cudnnCTCLoss\(\)](#).

Parameters

handle

Input. Handle to a previously created cuDNN context.

probsDesc

Input. Handle to the previously initialized probabilities tensor descriptor.

gradientsDesc

Input. Handle to a previously initialized gradient tensor descriptor.

labels

Input. Pointer to a previously initialized labels list.

labelLengths

Input. Pointer to a previously initialized lengths list, to walk the above labels list.

inputLengths

Input. Pointer to a previously initialized list of the lengths of the timing steps in each batch.

algo

Input. Enumerant that specifies the chosen CTC loss algorithm

ctcLossDesc

Input. Handle to the previously initialized CTC loss descriptor.

sizeInBytes

Output. Amount of GPU memory needed as workspace to be able to execute the CTC loss computation with the specified algo.

Returns

CUDNN_STATUS_SUCCESS

The query was successful.

CUDNN_STATUS_BAD_PARAM

At least one of the following conditions are met:

- ▶ The dimensions of `probsDesc` do not match the dimensions of `gradientsDesc`.
- ▶ The `inputLengths` do not agree with the first dimension of `probsDesc`.
- ▶ The `workSpaceSizeInBytes` is not sufficient.
- ▶ The `labelLengths` is greater than 256.

CUDNN_STATUS_NOT_SUPPORTED

A compute or data type other than `FLOAT` was chosen, or an unknown algorithm type was chosen.

8.2.13. **cudaGetCTCLossWorkspaceSize_v8()**

```

cudaStatus_t cudaGetCTCLossWorkspaceSize_v8(
    cudaHandle_t          handle,
    cudaCTCLossAlgo_t    algo,
    const cudaCTCLossDescriptor_t  ctcLossDesc,
    const cudaTensorDescriptor_t    probsDesc,
    const cudaTensorDescriptor_t    gradientsDesc,
    size_t                *sizeInBytes
)
    
```

This function returns the amount of GPU memory workspace the user needs to allocate to be able to call [cudnnCTCLoss_v8\(\)](#) with the specified algorithm. The workspace allocated will then be passed to the routine [cudnnCTCLoss_v8\(\)](#).

Parameters

handle

Input. Handle to a previously created cuDNN context.

algo

Input. Enumerant that specifies the chosen CTC loss algorithm.

ctcLossDesc

Input. Handle to the previously initialized CTC loss descriptor.

probsDesc

Input. Handle to the previously initialized probabilities tensor descriptor.

gradientsDesc

Input. Handle to a previously initialized gradient tensor descriptor.

sizeInBytes

Output. Amount of GPU memory needed as workspace to be able to execute the CTC loss computation with the specified algo.

Returns

CUDNN_STATUS_SUCCESS

The query was successful.

CUDNN_STATUS_BAD_PARAM

At least one of the following conditions are met:

- ▶ The dimensions of `probsDesc` do not match the dimensions of `gradientsDesc`.

CUDNN_STATUS_NOT_SUPPORTED

A compute or data type other than `FLOAT` was chosen, or an unknown algorithm type was chosen.

8.2.14. `cudnnGetRNNTrainingReserveSize()`

This function has been deprecated in cuDNN 8.0. Use [cudnnGetRNNTempSpaceSizes\(\)](#) instead of `cudnnGetRNNWorkspaceSize()`.

```

cudnnStatus_t cudnnGetRNNTrainingReserveSize(
    cudnnHandle_t      handle,
    const cudnnRNNDescriptor_t  rnnDesc,
    const int          seqLength,
    const cudnnTensorDescriptor_t *xDesc,
    size_t             *sizeInBytes)
    
```

This function is used to query the amount of reserved space required for training the RNN described by `rnnDesc` with input dimensions defined by `xDesc`. The same reserved space buffer must be passed to [`cudaRNNForwardTraining\(\)`](#), [`cudaRNNBackwardData\(\)`](#), and [`cudaRNNBackwardWeights\(\)`](#). Each of these calls overwrites the contents of the reserved space, however it can safely be backed up and restored between calls if reuse of the memory is desired.

Parameters

handle

Input. Handle to a previously created cuDNN library descriptor.

rnnDesc

Input. A previously initialized RNN descriptor.

seqLength

Input. Number of iterations to unroll over. The value of this `seqLength` must not exceed the value that was used in [`cudaGetRNNWorkspaceSize\(\)`](#) function for querying the workspace size required to execute the RNN.

xDesc

Input. An array of tensor descriptors describing the input to each recurrent iteration (one descriptor per iteration). The first dimension (batch size) of the tensors may decrease from element n to element $n+1$ but may not increase. Each tensor descriptor must have the same second dimension (vector length).

sizeInBytes

Output. Minimum amount of GPU memory needed as reserve space to be able to train an RNN with the specified descriptor and input tensors.

Returns

CUDNN_STATUS_SUCCESS

The query was successful.

CUDNN_STATUS_BAD_PARAM

At least one of the following conditions are met:

- ▶ The descriptor `rnnDesc` is invalid.
- ▶ At least one of the descriptors in `xDesc` is invalid.
- ▶ The descriptors in `xDesc` have inconsistent second dimensions, strides or data types.
- ▶ The descriptors in `xDesc` have increasing first dimensions.
- ▶ The descriptors in `xDesc` are not fully packed.

CUDNN_STATUS_NOT_SUPPORTED

The data types in tensors described by `xDesc` are not supported.

8.2.15. cudnnMultiHeadAttnBackwardData()

```

cudnnStatus_t cudnnMultiHeadAttnBackwardData(
    cudnnHandle_t handle,
    const cudnnAttnDescriptor_t attnDesc,
    const int loWinIdx[],
    const int hiWinIdx[],
    const int devSeqLengthsDQDO[],
    const int devSeqLengthsDKDV[],
    const cudnnSeqDataDescriptor_t doDesc,
    const void *dout,
    const cudnnSeqDataDescriptor_t dqDesc,
    void *dqueries,
    const void *queries,
    const cudnnSeqDataDescriptor_t dkDesc,
    void *dkeys,
    const void *keys,
    const cudnnSeqDataDescriptor_t dvDesc,
    void *dvalues,
    const void *values,
    size_t weightSizeInBytes,
    const void *weights,
    size_t workSpaceSizeInBytes,
    void *workSpace,
    size_t reserveSpaceSizeInBytes,
    void *reserveSpace);

```

This function computes exact, first-order derivatives of the multi-head attention block with respect to its inputs: $\mathbf{Q}, \mathbf{K}, \mathbf{V}$. If $\mathbf{y}=F(\mathbf{x})$ is a vector-valued function that represents the multi-head attention layer and it takes some vector $\mathbf{w} \in R^n$ as an input (with all other parameters and inputs constant), and outputs vector $\mathbf{y} \in R^m$, then `cudnnMultiHeadAttnBackwardData()` computes the result of $(\partial y_i / \partial x_j)^T \delta_{out}$ where δ_{out} is the $m \times 1$ gradient of the loss function with respect to multi-head attention outputs. The δ_{out} gradient is back propagated through prior layers of the deep learning model. $\partial y_i / \partial x_j$ is the $m \times n$ Jacobian matrix of $F(\mathbf{x})$. The input is supplied via the `dout` argument and gradient results for $\mathbf{Q}, \mathbf{K}, \mathbf{V}$ are written to the `dqueries`, `dkeys`, and `dvalues` buffers.

The `cudnnMultiHeadAttnBackwardData()` function does not output partial derivatives for residual connections because this result is equal to δ_{out} . If the multi-head attention model enables residual connections sourced directly from \mathbf{Q} , then the `dout` tensor needs to be added to `dqueries` to obtain the correct result of the latter. This operation is demonstrated in the `cuDNN multiHeadAttention` sample code.

The `cudnnMultiHeadAttnBackwardData()` function must be invoked after `cudnnMultiHeadAttnForward()`. The `loWinIdx[]`, `hiWinIdx[]`, `queries`, `keys`, `values`, `weights`, and `reserveSpace` arguments should be the same as in the `cudnnMultiHeadAttnForward()` call. `devSeqLengthsDQDO[]` and `devSeqLengthsDKDV[]` device arrays should contain the same start and end attention window indices as `devSeqLengthsQO[]` and `devSeqLengthsKV[]` arrays in the forward function invocation.



Note: `cudnnMultiHeadAttnBackwardData()` does not verify that sequence lengths stored in `devSeqLengthsDQDO[]` and `devSeqLengthsDKDV[]` contain the same settings as `seqLengthArray[]` in the corresponding sequence data descriptor.

Parameters

handle

Input. The current context handle.

attnDesc

Input. A previously initialized attention descriptor.

loWinIdx[], hiWinIdx[]

Input. Two host integer arrays specifying the start and end indices of the attention window for each **Q** time-step. The start index in **K, V** sets is inclusive, and the end index is exclusive.

devSeqLengthsDQDO[]

Input. Device array containing a copy of the sequence length array from the dqDesc or doDesc sequence data descriptor.

devSeqLengthsDKDV[]

Input. Device array containing a copy of the sequence length array from the dkDesc or dvDesc sequence data descriptor.

doDesc

Input. Descriptor for the δ_{out} gradients (vectors of partial derivatives of the loss function with respect to the multi-head attention outputs).

dout

Pointer to δ_{out} gradient data in the device memory.

dqDesc

Input. Descriptor for queries and dqueries sequence data.

dqueries

Output. Device pointer to gradients of the loss function computed with respect to queries vectors.

queries

Input. Pointer to queries data in the device memory. This is the same input as in [cudaMultiHeadAttnForward\(\)](#).

dkDesc

Input. Descriptor for keys and dkeys sequence data.

dkeys

Output. Device pointer to gradients of the loss function computed with respect to keys vectors.

keys

Input. Pointer to `keys` data in the device memory. This is the same input as in [cudnnMultiHeadAttnForward\(\)](#).

dvDesc

Input. Descriptor for `values` and `dvalues` sequence data.

dvalues

Output. Device pointer to gradients of the loss function computed with respect to `values` vectors.

values

Input. Pointer to `values` data in the device memory. This is the same input as in [cudnnMultiHeadAttnForward\(\)](#).

weightSizeInBytes

Input. Size of the `weight` buffer in bytes where all multi-head attention trainable parameters are stored.

weights

Input. Address of the `weight` buffer in the device memory.

workSpaceSizeInBytes

Input. Size of the work-space buffer in bytes used for temporary API storage.

workSpace

Input/Output. Address of the work-space buffer in the device memory.

reserveSpaceSizeInBytes

Input. Size of the reserve-space buffer in bytes used for data exchange between forward and backward (gradient) API calls.

reserveSpace

Input/Output. Address to the reserve-space buffer in the device memory.

Returns**CUDNN_STATUS_SUCCESS**

No errors were detected while processing API input arguments and launching GPU kernels.

CUDNN_STATUS_BAD_PARAM

An invalid or incompatible input argument was encountered.

CUDNN_STATUS_EXECUTION_FAILED

The process of launching a GPU kernel returned an error, or an earlier kernel did not complete successfully.

CUDNN_STATUS_INTERNAL_ERROR

An inconsistent internal state was encountered.

CUDNN_STATUS_NOT_SUPPORTED

A requested option or a combination of input arguments is not supported.

CUDNN_STATUS_ALLOC_FAILED

Insufficient amount of shared memory to launch a GPU kernel.

8.2.16. cudnnMultiHeadAttnBackwardWeights()

```

cudnnStatus_t cudnnMultiHeadAttnBackwardWeights(
    cudnnHandle_t handle,
    const cudnnAttnDescriptor_t attnDesc,
    cudnnWgradMode_t addGrad,
    const cudnnSeqDataDescriptor_t qDesc,
    const void *queries,
    const cudnnSeqDataDescriptor_t kDesc,
    const void *keys,
    const cudnnSeqDataDescriptor_t vDesc,
    const void *values,
    const cudnnSeqDataDescriptor_t doDesc,
    const void *dout,
    size_t weightSizeInBytes,
    const void *weights,
    void *dweights,
    size_t workSpaceSizeInBytes,
    void *workSpace,
    size_t reserveSpaceSizeInBytes,
    void *reserveSpace);
    
```

This function computes exact, first-order derivatives of the multi-head attention block with respect to its trainable parameters: projection weights and projection biases. If $\mathbf{y}=F(\mathbf{w})$ is a vector-valued function that represents the multi-head attention layer and it takes some vector $\mathbf{x}\in R^n$ of flatten weights or biases as an input (with all other parameters and inputs fixed), and outputs vector $\mathbf{y}\in R^m$, then `cudnnMultiHeadAttnBackwardWeights()` computes the result of $(\partial y_i / \partial x_j)^T \delta_{out}$ where δ_{out} is the $m \times 1$ gradient of the loss function with respect to multi-head attention outputs. The δ_{out} gradient is back propagated through prior layers of the deep learning model. $\partial y_i / \partial x_j$ is the $m \times n$ Jacobian matrix of $F(\mathbf{w})$. The δ_{out} input is supplied via the `dout` argument.

All gradient results with respect to weights and biases are written to the `dweights` buffer. The size and the organization of the `dweights` buffer is the same as the `weights` buffer that holds multi-head attention weights and biases. The `cuDNN multiHeadAttention` sample code demonstrates how to access those weights.

Gradient of the loss function with respect to weights or biases is typically computed over multiple batches. In such a case, partial results computed for each batch should be summed together. The `addGrad` argument specifies if the gradients from the current batch should be added to previously computed results or the `dweights` buffer should be overwritten with the new results.

The `cudnnMultiHeadAttnBackwardWeights()` function should be invoked after `cudnnMultiHeadAttnBackwardData()`. The `queries`, `keys`, `values`, `weights`, and

reserveSpace arguments should be the same as in [cudnnMultiHeadAttnForward\(\)](#) and [cudnnMultiHeadAttnBackwardData\(\)](#) calls. The dout argument should be the same as in [cudnnMultiHeadAttnBackwardData\(\)](#).

Parameters

handle

Input. The current context handle.

attnDesc

Input. A previously initialized attention descriptor.

addGrad

Input. Weight gradient output mode.

qDesc

Input. Descriptor for the query sequence data.

queries

Input. Pointer to queries sequence data in the device memory.

kDesc

Input. Descriptor for the keys sequence data.

keys

Input. Pointer to keys sequence data in the device memory.

vDesc

Input. Descriptor for the values sequence data.

values

Input. Pointer to values sequence data in the device memory.

doDesc

Input. Descriptor for the δ_{out} gradients (vectors of partial derivatives of the loss function with respect to the multi-head attention outputs).

dout

Input. Pointer to δ_{out} gradient data in the device memory.

weightSizeInBytes

Input. Size of the weights and dweights buffers in bytes.

weights

Input. Address of the weight buffer in the device memory.

dweights

Output. Address of the weight gradient buffer in the device memory.

workspaceSizeInBytes

Input. Size of the work-space buffer in bytes used for temporary API storage.

workspace

Input/Output. Address of the work-space buffer in the device memory.

reserveSpaceSizeInBytes

Input. Size of the reserve-space buffer in bytes used for data exchange between forward and backward (gradient) API calls.

reserveSpace

Input/Output. Address to the reserve-space buffer in the device memory.

Returns

CUDNN_STATUS_SUCCESS

No errors were detected while processing API input arguments and launching GPU kernels.

CUDNN_STATUS_BAD_PARAM

An invalid or incompatible input argument was encountered.

CUDNN_STATUS_EXECUTION_FAILED

The process of launching a GPU kernel returned an error, or an earlier kernel did not complete successfully.

CUDNN_STATUS_INTERNAL_ERROR

An inconsistent internal state was encountered.

CUDNN_STATUS_NOT_SUPPORTED

A requested option or a combination of input arguments is not supported.

8.2.17. **cudaRNNBackwardData()**

This function has been deprecated in cuDNN 8.0. Use [cudaRNNBackwardData_v8\(\)](#) instead of `cudaRNNBackwardData()`.

```

cudaStatus_t cudaRNNBackwardData(
    cudaHandle_t          handle,
    const cudaRNNDescriptor_t  rnnDesc,
    const int             seqLength,
    const cudaTensorDescriptor_t *yDesc,
    const void            *y,
    const cudaTensorDescriptor_t *dyDesc,
    const void            *dy,
    const cudaTensorDescriptor_t dhyDesc,
    const void            *dhy,
    const cudaTensorDescriptor_t dcyDesc,
    const void            *dcy,
    const cudaFilterDescriptor_t wDesc,
    const void            *w,
    const cudaTensorDescriptor_t hxDesc,
    const void            *hx,
    const cudaTensorDescriptor_t cxDesc,

```



```

const void          *cx,
const cudnnTensorDescriptor_t *dxDesc,
void               *dx,
const cudnnTensorDescriptor_t dhxDesc,
void               *dhx,
const cudnnTensorDescriptor_t dcxDesc,
void               *dcx,
void               *workspace,
size_t             workspaceSizeInBytes,
const void         *reserveSpace,
size_t             reserveSpaceSizeInBytes)

```

This routine executes the recurrent neural network described by `rnnDesc` with output gradients `dy`, `dhy`, and `dhc`, weights `w` and input gradients `dx`, `dhx`, and `dcx`. `workspace` is required for intermediate storage. The data in `reserveSpace` must have previously been generated by [cudnnRNNForwardTraining\(\)](#). The same `reserveSpace` data must be used for future calls to [cudnnRNNBackwardWeights\(\)](#) if they execute on the same input data.

Parameters

handle

Input. Handle to a previously created cuDNN context. For more information, see [cudnnHandle_t](#).

rnnDesc

Input. A previously initialized RNN descriptor. For more information, see [cudnnRNNDescriptor_t](#).

seqLength

Input. Number of iterations to unroll over. The value of this `seqLength` must not exceed the value that was used in the [cudnnGetRNNWorkspaceSize\(\)](#) function for querying the workspace size required to execute the RNN.

yDesc

Input. An array of fully packed tensor descriptors describing the output from each recurrent iteration (one descriptor per iteration). For more information, see [cudnnTensorDescriptor_t](#). The second dimension of the tensor depends on the `direction` argument used to initialize `rnnDesc`:

- ▶ If `direction` is `CUDNN_UNIDIRECTIONAL` the second dimension should match the `hiddenSize` argument.
- ▶ If `direction` is `CUDNN_BIDIRECTIONAL` the second dimension should match double the `hiddenSize` argument.

The first dimension of the tensor `n` must match the first dimension of the tensor `n` in `dyDesc`.

y

Input. Data pointer to GPU memory associated with the output tensor descriptor `yDesc`.

dyDesc

Input. An array of fully packed tensor descriptors describing the gradient at the output from each recurrent iteration (one descriptor per iteration). The second dimension of the tensor depends on the `direction` argument used to initialize `rnnDesc`:

- ▶ If `direction` is `CUDNN_UNIDIRECTIONAL` the second dimension should match the `hiddenSize` argument.
- ▶ If `direction` is `CUDNN_BIDIRECTIONAL` the second dimension should match double the `hiddenSize` argument.

The first dimension of the tensor `n` must match the first dimension of the tensor `n` in `dxDesc`.

dy

Input. Data pointer to GPU memory associated with the tensor descriptors in the array `dyDesc`.

dhyDesc

Input. A fully packed tensor descriptor describing the gradients at the final hidden state of the RNN. The first dimension of the tensor depends on the `direction` argument used to initialize `rnnDesc`:

- ▶ If `direction` is `CUDNN_UNIDIRECTIONAL` the first dimension should match the `numLayers` argument.
- ▶ If `direction` is `CUDNN_BIDIRECTIONAL` the first dimension should match double the `numLayers` argument.

The second dimension must match the first dimension of the tensors described in `xDesc`. The third dimension must match the `hiddenSize` argument used to initialize `rnnDesc`. The tensor must be fully packed.

dhy

Input. Data pointer to GPU memory associated with the tensor descriptor `dhyDesc`. If a `NULL` pointer is passed, the gradients at the final hidden state of the network will be initialized to zero.

dcyDesc

Input. A fully packed tensor descriptor describing the gradients at the final cell state of the RNN. The first dimension of the tensor depends on the `direction` argument used to initialize `rnnDesc`:

- ▶ If `direction` is `CUDNN_UNIDIRECTIONAL` the first dimension should match the `numLayers` argument.
- ▶ If `direction` is `CUDNN_BIDIRECTIONAL` the first dimension should match double the `numLayers` argument.

The second dimension must match the first dimension of the tensors described in `xDesc`. The third dimension must match the `hiddenSize` argument used to initialize `rnnDesc`. The tensor must be fully packed.

dcy

Input. Data pointer to GPU memory associated with the tensor descriptor `dcyDesc`. If a `NULL` pointer is passed, the gradients at the final cell state of the network will be initialized to zero.

wDesc

Input. Handle to a previously initialized filter descriptor describing the weights for the RNN. For more information, see [cudaFilterDescriptor_t](#).

w

Input. Data pointer to GPU memory associated with the filter descriptor `wDesc`.

hxDesc

Input. A fully packed tensor descriptor describing the initial hidden state of the RNN. The first dimension of the tensor depends on the `direction` argument used to initialize `rnnDesc`:

- ▶ If `direction` is `CUDNN_UNIDIRECTIONAL` the first dimension should match the `numLayers` argument.
- ▶ If `direction` is `CUDNN_BIDIRECTIONAL` the first dimension should match double the `numLayers` argument.

The second dimension must match the second dimension of the tensors described in `xDesc`. The third dimension must match the `hiddenSize` argument used to initialize `rnnDesc`. The tensor must be fully packed.

hx

Input. Data pointer to GPU memory associated with the tensor descriptor `hxDesc`. If a `NULL` pointer is passed, the initial hidden state of the network will be initialized to zero.

cxDesc

Input. A fully packed tensor descriptor describing the initial cell state for LSTM networks. The first dimension of the tensor depends on the `direction` argument used to initialize `rnnDesc`:

- ▶ If `direction` is `CUDNN_UNIDIRECTIONAL` the first dimension should match the `numLayers` argument.
- ▶ If `direction` is `CUDNN_BIDIRECTIONAL` the first dimension should match double the `numLayers` argument.

The second dimension must match the second dimension of the tensors described in `xDesc`. The third dimension must match the `hiddenSize` argument used to initialize `rnnDesc`. The tensor must be fully packed.

cx

Input. Data pointer to GPU memory associated with the tensor descriptor `cxDesc`. If a `NULL` pointer is passed, the initial cell state of the network will be initialized to zero.

dxDesc

Input. An array of fully packed tensor descriptors describing the gradient at the input of each recurrent iteration (one descriptor per iteration). The first dimension (batch size) of the tensors may decrease from element `n` to element `n+1` but may not increase. Each tensor descriptor must have the same second dimension (vector length).

dx

Output. Data pointer to GPU memory associated with the tensor descriptors in the array `dxDesc`.

dhxDesc

Input. A fully packed tensor descriptor describing the gradient at the initial hidden state of the RNN. The first dimension of the tensor depends on the `direction` argument used to initialize `rnnDesc`:

- ▶ If `direction` is `CUDNN_UNIDIRECTIONAL` the first dimension should match the `numLayers` argument.
- ▶ If `direction` is `CUDNN_BIDIRECTIONAL` the first dimension should match double the `numLayers` argument.

The second dimension must match the first dimension of the tensors described in `xDesc`. The third dimension must match the `hiddenSize` argument used to initialize `rnnDesc`. The tensor must be fully packed.

dhx

Output. Data pointer to GPU memory associated with the tensor descriptor `dhxDesc`. If a `NULL` pointer is passed, the gradient at the hidden input of the network will not be set.

dcxDesc

Input. A fully packed tensor descriptor describing the gradient at the initial cell state of the RNN. The first dimension of the tensor depends on the `direction` argument used to initialize `rnnDesc`:

- ▶ If `direction` is `CUDNN_UNIDIRECTIONAL` the first dimension should match the `numLayers` argument.
- ▶ If `direction` is `CUDNN_BIDIRECTIONAL` the first dimension should match double the `numLayers` argument.

The second dimension must match the first dimension of the tensors described in `xDesc`. The third dimension must match the `hiddenSize` argument used to initialize `rnnDesc`. The tensor must be fully packed.

dcx

Output. Data pointer to GPU memory associated with the tensor descriptor `dcxDesc`. If a `NULL` pointer is passed, the gradient at the cell input of the network will not be set.

workspace

Input. Data pointer to GPU memory to be used as a workspace for this call.

workspaceSizeInBytes

Input. Specifies the size in bytes of the provided `workspace`.

reserveSpace

Input/Output. Data pointer to GPU memory to be used as a reserve space for this call.

reserveSpaceSizeInBytes

Input. Specifies the size in bytes of the provided `reserveSpace`.

Returns

CUDNN_STATUS_SUCCESS

The function launched successfully.

CUDNN_STATUS_NOT_SUPPORTED

The function does not support the provided configuration.

CUDNN_STATUS_BAD_PARAM

At least one of the following conditions are met:

- ▶ The descriptor `rnnDesc` is invalid.
- ▶ At least one of the descriptors `dhxDesc`, `wDesc`, `hxDesc`, `cxDesc`, `dcxDesc`, `dhyDesc`, `dcyDesc` or one of the descriptors in `yDesc`, `dxDesc`, `dyDesc` is invalid.
- ▶ The descriptors in one of `yDesc`, `dxDesc`, `dyDesc`, `dhxDesc`, `wDesc`, `hxDesc`, `cxDesc`, `dcxDesc`, `dhyDesc`, `dcyDesc` has incorrect strides or dimensions.
- ▶ `workspaceSizeInBytes` is too small.
- ▶ `reserveSpaceSizeInBytes` is too small.

CUDNN_STATUS_INVALID_VALUE

[`cudaSetPersistentRNNPlan\(\)`](#) was not called prior to the current function when `CUDNN_RNN_ALGO_PERSIST_DYNAMIC` was selected in the RNN descriptor.

CUDNN_STATUS_MAPPING_ERROR

A GPU/CUDA resource, such as a texture object, shared memory, or zero-copy memory is not available in the required size or there is a mismatch between the user resource and cuDNN internal resources. A resource mismatch may occur, for example, when calling `cudaSetStream()`. There could be a mismatch between the user provided CUDA stream and the internal CUDA events instantiated in the cuDNN handle when `cudaCreate()` was invoked.

This error status may not be correctable when it is related to texture dimensions, shared memory size, or zero-copy memory availability. If CUDNN_STATUS_MAPPING_ERROR is returned by cudnnSetStream(), then it is typically correctable, however, it means that the cuDNN handle was created on one GPU and the user stream passed to this function is associated with another GPU.

CUDNN_STATUS_EXECUTION_FAILED

The function failed to launch on the GPU.

CUDNN_STATUS_ALLOC_FAILED

The function was unable to allocate memory.

8.2.18. cudnnRNNBackwardData_v8()

```

cudnnStatus_t cudnnRNNBackwardData_v8(
    cudnnHandle_t handle,
    cudnnRNNDescriptor_t rnnDesc,
    const int32_t devSeqLengths[],
    cudnnRNNDataDescriptor_t yDesc,
    const void *y,
    const void *dy,
    cudnnRNNDataDescriptor_t xDesc,
    void *dx,
    cudnnTensorDescriptor_t hDesc,
    const void *hx,
    const void *dhy,
    void *dhx,
    cudnnTensorDescriptor_t cDesc,
    const void *cx,
    const void *dcy,
    void *dcx,
    size_t weightSpaceSize,
    const void *weightSpace,
    size_t workSpaceSize,
    void *workSpace,
    size_t reserveSpaceSize,
    void *reserveSpace);

```

This function computes exact, first-order derivatives of the RNN model with respect to its inputs: x , hx and for the LSTM cell type also cx . If $\mathbf{o} = [\mathbf{y}, \mathbf{hy}, \mathbf{cy}] = F(\mathbf{x}, \mathbf{hx}, \mathbf{cx}) = F(\mathbf{z})$ is a vector-valued function that represents the entire RNN model and it takes vectors x (for all time-steps) and vectors hx, cx (for all layers) as inputs, concatenated into $\mathbf{z} \in R^n$ (network weights and biases are assumed constant), and outputs vectors y, hy, cy concatenated into a vector $\mathbf{o} \in R^m$, then `cudnnRNNBackwardData_v8()` computes the result of $(\partial o_i / \partial z_j)^T \delta_{out}$ where δ_{out} is the $m \times 1$ gradient of the loss function with respect to all RNN outputs. The δ_{out} gradient is back propagated through prior layers of the deep learning model, starting from the model output. $\partial o_i / \partial z_j$ is the $m \times n$ Jacobian matrix of $F(\mathbf{z})$. The δ_{out} input is supplied via the `dy`, `dhy`, and `dcy` arguments and gradient results $(\partial o_i / \partial z_j)^T \delta_{out}$ are written to the `dx`, `dhx`, and `dcx` buffers.

Locations of $x, y, hx, cx, hy, cy, dx, dy, dhx, dcx, dhy$, and `dcy` signals a multi-layer RNN model are shown in the Figure below. Note that internal RNN signals (between time-steps and between layers) are not exposed by the `cudnnRNNBackwardData_v8()` function.

Figure 3. Locations of x , y , h_x , c_x , h_y , c_y , dx , dy , dh_x , dc_x , dh_y , and dc_y signals a multi-layer RNN model.

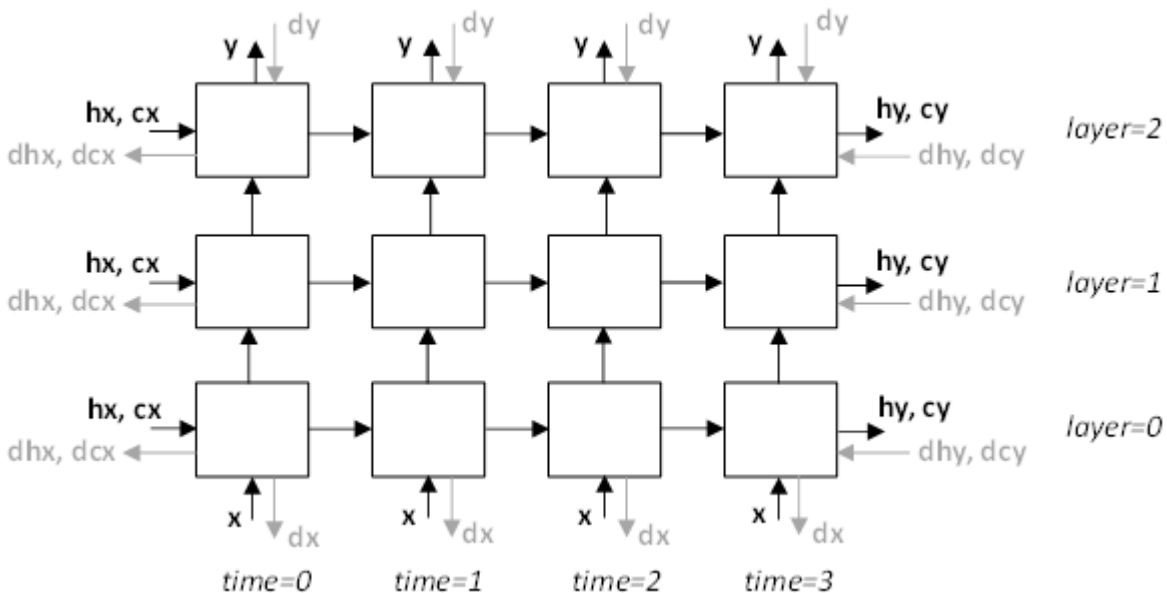

Memory addresses to the primary RNN output y , the initial hidden state h_x , and the initial cell state c_x (for LSTM only) should point to the same data as in the preceding `cudaRNNForward()` call. The dy and dx pointers cannot be NULL.

The `cudaRNNBackwardData_v8()` function accepts any combination of dh_y , dh_x , dc_y , dc_x buffer addresses being NULL. When dh_y or dc_y are NULL, it is assumed that those inputs are zero. When dh_x or dc_x pointers are NULL then the corresponding results are not written by `cudaRNNBackwardData_v8()`.

When all h_x , dh_y , dh_x pointers are NULL, then the corresponding tensor descriptor `hDesc` can be NULL too. The same rule applies to the c_x , dc_y , dc_x pointers and the `cDesc` tensor descriptor.

The `cudaRNNBackwardData_v8()` function allows the user to use padded layouts for inputs y , dy , and output dx . In padded or unpacked layouts (`CUDNN_RNN_DATA_LAYOUT_SEQ_MAJOR_UNPACKED`, `CUDNN_RNN_DATA_LAYOUT_BATCH_MAJOR_UNPACKED`) each sequence of vectors in a mini-batch has a fixed length defined by the `maxSeqLength` argument in the `cudaSetRNNDataDescriptor()` function. The term "unpacked" refers here to the presence of padding vectors, and not unused address ranges between contiguous vectors.

Each padded, fixed-length sequence starts from a segment of valid vectors. The valid vector count is stored in `seqLengthArray` passed to `cudaSetRNNDataDescriptor()`, such that $0 < seqLengthArray[i] \leq maxSeqLength$ for all sequences in a mini-batch, i.e., for $i=0..batchSize-1$. The remaining padding vectors make the combined sequence length equal to `maxSeqLength`. Both sequence-major and batch-major padded layouts are supported.

In addition, a packed sequence-major layout: `CUDNN_RNN_DATA_LAYOUT_SEQ_MAJOR_PACKED` can be selected by the user. In the latter layout, sequences of vectors in a mini-batch are sorted in the descending order according to the sequence lengths. First, all vectors for time

step zero are stored. They are followed by vectors for time step one, and so on. This layout uses no padding vectors.

The same layout type must be specified in `xDesc` and `yDesc` descriptors.

Two host arrays named `seqLengthArray` in `xDesc` and `yDesc` RNN data descriptors must be the same. In addition, a copy of `seqLengthArray` in the device memory must be passed via the `devSeqLengths` argument. This array is supplied directly to GPU kernels. The `cudaRNNBackwardData_v8()` function does not verify that sequence lengths stored in `devSeqLengths` in GPU memory are the same as in `xDesc` and `yDesc` descriptors in CPU memory. Sequence length arrays from `xDesc` and `yDesc` descriptors are checked for consistency, however.

The `cudaRNNBackwardData_v8()` function must be called after [cudaRNNForward\(\)](#). The [cudaRNNForward\(\)](#) function should be invoked with the `fwMode` argument of type [cudaRNNForward\(\)](#) set to `CUDNN_FWD_MODE_TRAINING`.

Parameters

handle

Input. The current cuDNN context handle.

rnnDesc

Input. A previously initialized RNN descriptor.

devSeqLengths

Input. A copy of `seqLengthArray` from `xDesc` or `yDesc` RNN data descriptors. The `devSeqLengths` array must be stored in GPU memory as it is accessed asynchronously by GPU kernels, possibly after the `cudaRNNBackwardData_v8()` function exists. This argument cannot be `NULL`.

yDesc

Input. A previously initialized descriptor corresponding to the RNN model primary output. The `dataType`, `layout`, `maxSeqLength`, `batchSize`, and `seqLengthArray` need to match that of `xDesc`.

y, dy

Input. Data pointers to GPU buffers holding the RNN model primary output and gradient deltas (gradient of the loss function with respect to `y`). The `y` output should be produced by the preceding [cudaRNNForward\(\)](#) call. The `y` and `dy` vectors are expected to be laid out in memory according to the layout specified by `yDesc`. The elements in the tensor (including elements in padding vectors) must be densely packed. The `y` and `dy` arguments cannot be `NULL`.

xDesc

Input. A previously initialized RNN data descriptor corresponding to the gradient of the loss function with respect to the RNN primary model input. The `dataType`, `layout`, `maxSeqLength`, `batchSize`, and `seqLengthArray` must match that of `yDesc`.

The parameter `vectorSize` must match the `inputSize` argument passed to the [`cudaSetRNNDescrptor_v8\(\)`](#) function.

dx

Output. Data pointer to GPU memory where back-propagated gradients of the loss function with respect to the RNN primary input `x` should be stored. The vectors are expected to be arranged in memory according to the layout specified by `xDesc`. The elements in the tensor (including padding vectors) must be densely packed. This argument cannot be `NULL`.

hDesc

Input. A tensor descriptor describing the initial RNN hidden state `hx` and gradients of the loss function with respect to the initial of final hidden state. Hidden state data and the corresponding gradients are fully packed. The first dimension of the tensor depends on the `dirMode` argument passed to the [`cudaSetRNNDescrptor_v8\(\)`](#) function.

- ▶ If `dirMode` is `CUDNN_UNIDIRECTIONAL`, then the first dimension should match the `numLayers` argument passed to [`cudaSetRNNDescrptor_v8\(\)`](#).
- ▶ If `dirMode` is `CUDNN_BIDIRECTIONAL`, then the first dimension should be double the `numLayers` argument passed to [`cudaSetRNNDescrptor_v8\(\)`](#).

The second dimension must match the `batchSize` parameter described in `xDesc`. The third dimension depends on whether RNN mode is `CUDNN_LSTM` and whether the LSTM projection is enabled. Specifically:

- ▶ If RNN mode is `CUDNN_LSTM` and LSTM projection is enabled, the third dimension must match the `projSize` argument passed to the [`cudaSetRNNDescrptor_v8\(\)`](#) call.
- ▶ Otherwise, the third dimension must match the `hiddenSize` argument passed to the [`cudaSetRNNDescrptor_v8\(\)`](#) call used to initialize `rnnDesc`.

hx, dhy

Input. Addresses of GPU buffers with the RNN initial hidden state `hx` and gradient deltas `dhy`. Data dimensions are described by the `hDesc` tensor descriptor. If a `NULL` pointer is passed in `hx` or `dhy` arguments, the corresponding buffer is assumed to contain all zeros.

dhx

Output. Pointer to the GPU buffer where first-order derivatives corresponding to initial hidden state variables should be stored. Data dimensions are described by the `hDesc` tensor descriptor. If a `NULL` pointer is assigned to `dhx`, the back-propagated derivatives are not saved.

cDesc

Input. For LSTM networks only. A tensor descriptor describing the initial cell state `cx` and gradients of the loss function with respect to the initial of final cell state. Cell state data are fully packed. The first dimension of the tensor depends on the `dirMode` argument passed to the [`cudaSetRNNDescrptor_v8\(\)`](#) call.

- ▶ If `dirMode` is `CUDNN_UNIDIRECTIONAL`, then the first dimension should match the `numLayers` argument passed to `cudaSetRNNDescriptor_v8()`.
- ▶ If `dirMode` is `CUDNN_BIDIRECTIONAL`, then the first dimension should be double the `numLayers` argument passed to `cudaSetRNNDescriptor_v8()`.

The second tensor dimension must match the `batchSize` parameter in `xDesc`.

The third dimension must match the `hiddenSize` argument passed to the `cudaSetRNNDescriptor_v8()` call.

cx, dcy

Input. For LSTM networks only. Addresses of GPU buffers with the initial LSTM state data and gradient deltas `dcy`. Data dimensions are described by the `cDesc` tensor descriptor. If a `NULL` pointer is passed in `cx` or `dcy` arguments, the corresponding buffer is assumed to contain all zeros.

dcx

Output. For LSTM networks only. Pointer to the GPU buffer where first-order derivatives corresponding to initial LSTM state variables should be stored. Data dimensions are described by the `cDesc` tensor descriptor. If a `NULL` pointer is assigned to `dcx`, the back-propagated derivatives are not saved.

weightSpaceSize

Input. Specifies the size in bytes of the provided weight-space buffer.

weightSpace

Input. Address of the weight space buffer in GPU memory.

workSpaceSize

Input. Specifies the size in bytes of the provided workspace buffer.

workSpace

Input/Output. Address of the workspace buffer in GPU memory to store temporary data.

reserveSpaceSize

Input. Specifies the size in bytes of the reserve-space buffer.

reserveSpace

Input/Output. Address of the reserve-space buffer in GPU memory.

Returns

CUDNN_STATUS_SUCCESS

No errors were detected while processing API input arguments and launching GPU kernels.

CUDNN_STATUS_NOT_SUPPORTED

At least one of the following conditions are met:

- ▶ variable sequence length input is passed while CUDNN_RNN_ALGO_PERSIST_STATIC or CUDNN_RNN_ALGO_PERSIST_DYNAMIC is specified
- ▶ CUDNN_RNN_ALGO_PERSIST_STATIC or CUDNN_RNN_ALGO_PERSIST_DYNAMIC is requested on pre-Pascal devices
- ▶ the 'double' floating point type is used for input/output and the CUDNN_RNN_ALGO_PERSIST_STATIC algo

CUDNN_STATUS_BAD_PARAM

An invalid or incompatible input argument was encountered. For example:

- ▶ some input descriptors are NULL
- ▶ settings in rnnDesc, xDesc, yDesc, hDesc, or cDesc descriptors are invalid
- ▶ weightSpaceSize, workSpaceSize, or reserveSpaceSize is too small

CUDNN_STATUS_MAPPING_ERROR

A GPU/CUDA resource, such as a texture object, shared memory, or zero-copy memory is not available in the required size or there is a mismatch between the user resource and cuDNN internal resources. A resource mismatch may occur, for example, when calling cudnnSetStream(). There could be a mismatch between the user provided CUDA stream and the internal CUDA events instantiated in the cuDNN handle when cudnnCreate() was invoked.

This error status may not be correctable when it is related to texture dimensions, shared memory size, or zero-copy memory availability. If CUDNN_STATUS_MAPPING_ERROR is returned by cudnnSetStream(), then it is typically correctable, however, it means that the cuDNN handle was created on one GPU and the user stream passed to this function is associated with another GPU.

CUDNN_STATUS_EXECUTION_FAILED

The process of launching a GPU kernel returned an error, or an earlier kernel did not complete successfully.

CUDNN_STATUS_ALLOC_FAILED

The function was unable to allocate CPU memory.

8.2.19. cudnnRNNBackwardDataEx()

This function has been deprecated in cuDNN 8.0. Use [cudnnRNNBackwardData_v8](#) instead of cudnnRNNBackwardDataEx().

```

cudnnStatus_t cudnnRNNBackwardDataEx(
    cudnnHandle_t          handle,
    const cudnnRNNDescriptor_t  rnnDesc,
    const cudnnRNNDataDescriptor_t  yDesc,
    const void             *y,
    const cudnnRNNDataDescriptor_t  dyDesc,
    const void             *dy,
    const cudnnRNNDataDescriptor_t  dcDesc,

```

```

const void *dcAttn,
const cudnnTensorDescriptor_t dhyDesc,
const void *dhy,
const cudnnTensorDescriptor_t dcyDesc,
const void *dcy,
const cudnnFilterDescriptor_t wDesc,
const void *w,
const cudnnTensorDescriptor_t hxDesc,
const void *hx,
const cudnnTensorDescriptor_t cxDesc,
const void *cx,
const cudnnRNNDataDescriptor_t dxDesc,
void *dx,
const cudnnTensorDescriptor_t dhxDesc,
void *dhx,
const cudnnTensorDescriptor_t dcxDesc,
void *dcx,
const cudnnRNNDataDescriptor_t dkDesc,
void *dkeys,
void *workSpace,
size_t workSpaceSizeInBytes,
void *reserveSpace,
size_t reserveSpaceSizeInBytes)

```

This routine is the extended version of the function [cudnnRNNBackwardData\(\)](#). This function `cudnnRNNBackwardDataEx()` allows the user to use an unpacked (padded) layout for input `y` and output `dx`.

In the unpacked layout, each sequence in the mini-batch is considered to be of fixed length, specified by `maxSeqLength` in its corresponding `RNNDataDescriptor`. Each fixed-length sequence, for example, the `n`th sequence in the mini-batch, is composed of a valid segment specified by the `seqLengthArray[n]` in its corresponding `RNNDataDescriptor`; and a padding segment to make the combined sequence length equal to `maxSeqLength`.

With the unpacked layout, both sequence major (meaning, time major) and batch major are supported. For backward compatibility, the packed sequence major layout is supported. However, similar to the non-extended function [cudnnRNNBackwardData\(\)](#), the sequences in the mini-batch need to be sorted in descending order according to length.

Parameters

handle

Input. Handle to a previously created This function is deprecated starting in cuDNN 8.0.0. context.

rnnDesc

Input. A previously initialized RNN descriptor.

yDesc

Input. A previously initialized RNN data descriptor. Must match or be the exact same descriptor previously passed into [cudnnRNNForwardTrainingEx\(\)](#).

y

Input. Data pointer to the GPU memory associated with the RNN data descriptor `yDesc`. The vectors are expected to be laid out in memory according to the layout specified by `yDesc`. The elements in the tensor (including elements in the padding vector) must be

densely packed, and no strides are supported. Must contain the exact same data previously produced by [cudaRNNForwardTrainingEx\(\)](#).

dyDesc

Input. A previously initialized RNN data descriptor. The `dataType`, `layout`, `maxSeqLength`, `batchSize`, `vectorSize`, and `seqLengthArray` need to match the `yDesc` previously passed to [cudaRNNForwardTrainingEx\(\)](#).

dy

Input. Data pointer to the GPU memory associated with the RNN data descriptor `dyDesc`. The vectors are expected to be laid out in memory according to the layout specified by `dyDesc`. The elements in the tensor (including elements in the padding vector) must be densely packed, and no strides are supported.

dhyDesc

Input. A fully packed tensor descriptor describing the gradients at the final hidden state of the RNN. The first dimension of the tensor depends on the `direction` argument used to initialize `rnnDesc`. Additionally:

- ▶ If `direction` is `CUDNN_UNIDIRECTIONAL` the first dimension should match the `numLayers` argument.
- ▶ If `direction` is `CUDNN_BIDIRECTIONAL` the first dimension should match double the `numLayers` argument.

The second dimension must match the `batchSize` parameter in `xDesc`. The third dimension depends on whether the RNN mode is `CUDNN_LSTM` and whether LSTM projection is enabled. Additionally:

- ▶ If the RNN mode is `CUDNN_LSTM` and LSTM projection is enabled, the third dimension must match the `recProjSize` argument passed to [cudaSetRNNProjectionLayers\(\)](#) call used to set `rnnDesc`.
- ▶ Otherwise, the third dimension must match the `hiddenSize` argument used to initialize `rnnDesc`.

dhy

Input. Data pointer to GPU memory associated with the tensor descriptor `dhyDesc`. If a `NULL` pointer is passed, the gradients at the final hidden state of the network will be initialized to zero.

dcyDesc

Input. A fully packed tensor descriptor describing the gradients at the final cell state of the RNN. The first dimension of the tensor depends on the `direction` argument used to initialize `rnnDesc`. Additionally:

- ▶ If `direction` is `CUDNN_UNIDIRECTIONAL` the first dimension should match the `numLayers` argument.

- ▶ If `direction` is `CUDNN_BIDIRECTIONAL` the first dimension should match double the `numLayers` argument.

The second dimension must match the first dimension of the tensors described in `xDesc`. The third dimension must match the `hiddenSize` argument used to initialize `rnnDesc`. The tensor must be fully packed.

dcy

Input. Data pointer to GPU memory associated with the tensor descriptor `dcyDesc`. If a `NULL` pointer is passed, the gradients at the final cell state of the network will be initialized to zero.

wDesc

Input. Handle to a previously initialized filter descriptor describing the weights for the RNN.

w

Input. Data pointer to GPU memory associated with the filter descriptor `wDesc`.

hxDesc

Input. A fully packed tensor descriptor describing the initial hidden state of the RNN. Must match or be the exact same descriptor previously passed into [`cudaRNNForwardTrainingEx\(\)`](#).

hx

Input. Data pointer to GPU memory associated with the tensor descriptor `hxDesc`. If a `NULL` pointer is passed, the initial hidden state of the network will be initialized to zero. Must contain the exact same data previously passed into [`cudaRNNForwardTrainingEx\(\)`](#), or be `NULL` if `NULL` was previously passed to [`cudaRNNForwardTrainingEx\(\)`](#).

cxDesc

Input. A fully packed tensor descriptor describing the initial cell state for LSTM networks. Must match or be the exact same descriptor previously passed into [`cudaRNNForwardTrainingEx\(\)`](#).

cx

Input. Data pointer to GPU memory associated with the tensor descriptor `cxDesc`. If a `NULL` pointer is passed, the initial cell state of the network will be initialized to zero. Must contain the exact same data previously passed into [`cudaRNNForwardTrainingEx\(\)`](#), or be `NULL` if `NULL` was previously passed to [`cudaRNNForwardTrainingEx\(\)`](#).

dxDesc

Input. A previously initialized RNN data descriptor. The `dataType`, `layout`, `maxSeqLength`, `batchSize`, `vectorSize` and `seqLengthArray` need to match that of `xDesc` previously passed to [`cudaRNNForwardTrainingEx\(\)`](#).

dx

Output. Data pointer to the GPU memory associated with the RNN data descriptor `dxDesc`. The vectors are expected to be laid out in memory according to the layout specified by `dxDesc`. The elements in the tensor (including elements in the padding vector) must be densely packed, and no strides are supported.

dhxDesc

Input. A fully packed tensor descriptor describing the gradient at the initial hidden state of the RNN. The descriptor must be set exactly the same way as `dhYDesc`.

dhx

Output. Data pointer to GPU memory associated with the tensor descriptor `dhxDesc`. If a `NULL` pointer is passed, the gradient at the hidden input of the network will not be set.

dcxDesc

Input. A fully packed tensor descriptor describing the gradient at the initial cell state of the RNN. The descriptor must be set exactly the same way as `dcyDesc`.

dcx

Output. Data pointer to GPU memory associated with the tensor descriptor `dcxDesc`. If a `NULL` pointer is passed, the gradient at the cell input of the network will not be set.

dkDesc

Reserved. Users may pass in `NULL`.

dkeys

Reserved. Users may pass in `NULL`.

workspace

Input. Data pointer to GPU memory to be used as a workspace for this call.

workSpaceSizeInBytes

Input. Specifies the size in bytes of the provided `workspace`.

reserveSpace

Input/Output. Data pointer to GPU memory to be used as a reserve space for this call.

reserveSpaceSizeInBytes

Input. Specifies the size in bytes of the provided `reserveSpace`.

Returns**CUDNN_STATUS_SUCCESS**

The function launched successfully.

CUDNN_STATUS_NOT_SUPPORTED

At least one of the following conditions are met:

- ▶ Variable sequence length input is passed in while CUDNN_RNN_ALGO_PERSIST_STATIC or CUDNN_RNN_ALGO_PERSIST_DYNAMIC is used.
- ▶ CUDNN_RNN_ALGO_PERSIST_STATIC or CUDNN_RNN_ALGO_PERSIST_DYNAMIC is used on pre-Pascal devices.
- ▶ Double input/output is used for CUDNN_RNN_ALGO_PERSIST_STATIC.

CUDNN_STATUS_BAD_PARAM

At least one of the following conditions are met:

- ▶ The descriptor rnnDesc is invalid.
- ▶ At least one of the descriptors yDesc, dxdesc, dydesc, dhxDesc, wDesc, hxDesc, cxDesc, dcxDesc, dhyDesc, dcyDesc is invalid or has incorrect strides or dimensions.
- ▶ workspaceSizeInBytes is too small.
- ▶ reserveSpaceSizeInBytes is too small.

CUDNN_STATUS_INVALID_VALUE

[cudnnSetPersistentRNNPlan\(\)](#) was not called prior to the current function when CUDNN_RNN_ALGO_PERSIST_DYNAMIC was selected in the RNN descriptor.

CUDNN_STATUS_MAPPING_ERROR

A GPU/CUDA resource, such as a texture object, shared memory, or zero-copy memory is not available in the required size or there is a mismatch between the user resource and cuDNN internal resources. A resource mismatch may occur, for example, when calling `cudnnSetStream()`. There could be a mismatch between the user provided CUDA stream and the internal CUDA events instantiated in the cuDNN handle when `cudnnCreate()` was invoked.

This error status may not be correctable when it is related to texture dimensions, shared memory size, or zero-copy memory availability. If `CUDNN_STATUS_MAPPING_ERROR` is returned by `cudnnSetStream()`, then it is typically correctable, however, it means that the cuDNN handle was created on one GPU and the user stream passed to this function is associated with another GPU.

CUDNN_STATUS_EXECUTION_FAILED

The function failed to launch on the GPU.

CUDNN_STATUS_ALLOC_FAILED

The function was unable to allocate memory.

8.2.20. `cudnnRNNBackwardWeights()`

This function has been deprecated in cuDNN 8.0. Use [cudnnRNNBackwardWeights_v8\(\)](#) instead of `cudnnRNNBackwardWeights()`.

```

cudnnStatus_t cudnnRNNBackwardWeights(
    cudnnHandle_t          handle,
    const cudnnRNNDescriptor_t  rnnDesc,

```



```

const int          seqLength,
const cudnnTensorDescriptor_t *xDesc,
const void        *x,
const cudnnTensorDescriptor_t hxDesc,
const void        *hx,
const cudnnTensorDescriptor_t *yDesc,
const void        *y,
const void        *workspace,
size_t            workspaceSizeInBytes,
const cudnnFilterDescriptor_t dwDesc,
void              *dw,
const void        *reserveSpace,
size_t            reserveSpaceSizeInBytes)

```

This routine accumulates weight gradients `dw` from the recurrent neural network described by `rnnDesc` with inputs `x`, `hx` and outputs `y`. The mode of operation in this case is additive, the weight gradients calculated will be added to those already existing in `dw`. `workspace` is required for intermediate storage. The data in `reserveSpace` must have previously been generated by [cudnnRNNBackwardData\(\)](#).

Parameters

handle

Input. Handle to a previously created cuDNN context.

rnnDesc

Input. A previously initialized RNN descriptor.

seqLength

Input. Number of iterations to unroll over. The value of this `seqLength` must not exceed the value that was used in [cudnnGetRNNWorkspaceSize\(\)](#) function for querying the workspace size required to execute the RNN.

xDesc

Input. An array of fully packed tensor descriptors describing the input to each recurrent iteration (one descriptor per iteration). The first dimension (batch size) of the tensors may decrease from element `n` to element `n+1` but may not increase. Each tensor descriptor must have the same second dimension (vector length).

x

Input. Data pointer to GPU memory associated with the tensor descriptors in the array `xDesc`.

hxDesc

Input. A fully packed tensor descriptor describing the initial hidden state of the RNN. The first dimension of the tensor depends on the `direction` argument used to initialize `rnnDesc`:

- ▶ If `direction` is `CUDNN_UNIDIRECTIONAL` the first dimension should match the `numLayers` argument.
- ▶ If `direction` is `CUDNN_BIDIRECTIONAL` the first dimension should match double the `numLayers` argument.

The second dimension must match the first dimension of the tensors described in `xDesc`. The third dimension must match the `hiddenSize` argument used to initialize `rnnDesc`. The tensor must be fully packed.

hx

Input. Data pointer to GPU memory associated with the tensor descriptor `hxDesc`. If a `NULL` pointer is passed, the initial hidden state of the network will be initialized to zero.

yDesc

Input. An array of fully packed tensor descriptors describing the output from each recurrent iteration (one descriptor per iteration). The second dimension of the tensor depends on the `direction` argument used to initialize `rnnDesc`:

- ▶ If `direction` is `CUDNN_UNIDIRECTIONAL` the second dimension should match the `hiddenSize` argument.
- ▶ If `direction` is `CUDNN_BIDIRECTIONAL` the second dimension should match double the `hiddenSize` argument.

The first dimension of the tensor `n` must match the first dimension of the tensor `n` in `dyDesc`.

y

Input. Data pointer to GPU memory associated with the output tensor descriptor `yDesc`.

workspace

Input. Data pointer to GPU memory to be used as a workspace for this call.

workSpaceSizeInBytes

Input. Specifies the size in bytes of the provided `workspace`.

dwDesc

Input. Handle to a previously initialized filter descriptor describing the gradients of the weights for the RNN.

dw

Input/Output. Data pointer to GPU memory associated with the filter descriptor `dwDesc`.

reserveSpace

Input. Data pointer to GPU memory to be used as a reserve space for this call.

reserveSpaceSizeInBytes

Input. Specifies the size in bytes of the provided `reserveSpace`.

Returns**CUDNN_STATUS_SUCCESS**

The function launched successfully.

CUDNN_STATUS_NOT_SUPPORTED

The function does not support the provided configuration.

CUDNN_STATUS_BAD_PARAM

At least one of the following conditions are met:

- ▶ The descriptor `rnnDesc` is invalid.
- ▶ At least one of the descriptors `hxDesc`, `dwDesc` or one of the descriptors in `xDesc`, `yDesc` is invalid.
- ▶ The descriptors in one of `xDesc`, `hxDesc`, `yDesc`, `dwDesc` have incorrect strides or dimensions.
- ▶ `workSpaceSizeInBytes` is too small.
- ▶ `reserveSpaceSizeInBytes` is too small.

CUDNN_STATUS_EXECUTION_FAILED

The function failed to launch on the GPU.

CUDNN_STATUS_ALLOC_FAILED

The function was unable to allocate memory.

8.2.21. `cudnnRNNBackwardWeights_v8()`

```

cudnnStatus_t cudnnRNNBackwardWeights_v8(
    cudnnHandle_t handle,
    cudnnRNNDescriptor_t rnnDesc,
    cudnnWgradMode_t addGrad,
    const int32_t devSeqLengths[],
    cudnnRNNDataDescriptor_t xDesc,
    const void *x,
    cudnnTensorDescriptor_t hDesc,
    const void *hx,
    cudnnRNNDataDescriptor_t yDesc,
    const void *y,
    size_t weightSpaceSize,
    void *dweightSpace,
    size_t workSpaceSize,
    void *workSpace,
    size_t reserveSpaceSize,
    void *reserveSpace);

```

This function computes exact, first-order derivatives of the RNN model with respect to all trainable parameters: weights and biases. If $\mathbf{o} = [\mathbf{y}, \mathbf{h}_y, \mathbf{c}_y] = F(\mathbf{w})$ is a vector-valued function that represents the multi-layer RNN model and it takes some vector $\mathbf{w} \in R^n$ of "flatten" weights or biases as input (with all other data inputs constant), and outputs vector $\mathbf{o} \in R^m$, then `cudnnRNNBackwardWeights_v8()` computes the result of $(\partial o_i / \partial w_j)^T \delta_{\text{out}}$ where δ_{out} is the $\mathbf{m} \times 1$ gradient of the loss function with respect to all RNN outputs. The δ_{out} gradient is back propagated through prior layers of the deep learning model, starting from the model output. $\partial o_i / \partial w_j$ is the $\mathbf{m} \times \mathbf{n}$ Jacobian matrix of $F(\mathbf{w})$. The δ_{out} input is supplied via the `dy`, `dhy`, and `dcy` arguments in the `cudnnRNNBackwardData_v8()` function.

All gradient results $(\partial o_i / \partial w_j)^T \delta_{out}$ with respect to weights and biases are written to the `dweightSpace` buffer. The size and the organization of the `dweightSpace` buffer is the same as the `weightSpace` buffer that holds RNN weights and biases.

Gradient of the loss function with respect to weights and biases is typically computed over multiple mini-batches. In such a case, partial results computed for each mini-batch should be aggregated. The `addGrad` argument specifies if gradients from the current mini-batch should be added to previously computed results (`CUDNN_WGRAD_MODE_ADD`) or the `dweightSpace` buffer should be overwritten with the new results (`CUDNN_WGRAD_MODE_SET`). Currently, the `cudaRNNBackwardWeights_v8()` function supports the `CUDNN_WGRAD_MODE_ADD` mode only so the `dweightSpace` buffer should be zeroed by the user before invoking the routine for the first time.

The same sequence lengths must be specified in the `xDesc` descriptor and in the device array `devSeqLengths`. The `cudaRNNBackwardWeights_v8()` function should be invoked after `cudaRNNBackwardData()`.

Parameters

handle

Input. The current cuDNN context handle.

rnnDesc

Input. A previously initialized RNN descriptor.

addGrad

Input. Weight gradient output mode. For more details, see the description of the `cudaWgradMode_t` enumerated type. Currently, only the `CUDNN_WGRAD_MODE_ADD` mode is supported by the `cudaRNNBackwardWeights_v8()` function.

devSeqLengths

Input. A copy of `seqLengthArray` from the `xDesc` RNN data descriptor. The `devSeqLengths` array must be stored in GPU memory as it is accessed asynchronously by GPU kernels, possibly after the `cudaRNNBackwardWeights_v8()` function exists.

xDesc

Input. A previously initialized descriptor corresponding to the RNN model input data. This is the same RNN data descriptor as used in the preceding `cudaRNNForward()` and `cudaRNNBackwardData_v8()` calls.

x

Input. Pointer to the GPU buffer with the primary RNN input. The same buffer address `x` should be provided in prior `cudaRNNForward()` and `cudaRNNBackwardData_v8()` calls.

hDesc

Input. A tensor descriptor describing the initial RNN hidden state. Hidden state data are fully packed. This is the same tensor descriptor as used in prior `cudaRNNForward()` and `cudaRNNBackwardData_v8()` calls.

hx

Input. Pointer to the GPU buffer with the RNN initial hidden state. The same buffer address `hx` should be provided in prior [cudaRNNForward\(\)](#) and [cudaRNNBackwardData_v8\(\)](#) calls.

yDesc

Input. A previously initialized descriptor corresponding to the RNN model output data. This is the same RNN data descriptor as used in prior [cudaRNNForward\(\)](#) and [cudaRNNBackwardData_v8\(\)](#) calls.

y

Output. Pointer to the GPU buffer with the primary RNN output as generated by the prior [cudaRNNForward\(\)](#) call. Data in the `y` buffer are described by the `yDesc` descriptor. Elements in the `y` tensor (including elements in padding vectors) must be densely packed.

weightSpaceSize

Input. Specifies the size in bytes of the provided weight-space buffer.

dweightSpace

Output. Address of the weight space buffer in GPU memory.

workSpaceSize

Input. Specifies the size in bytes of the provided workspace buffer.

workSpace

Input/Output. Address of the workspace buffer in GPU memory to store temporary data.

reserveSpaceSize

Input. Specifies the size in bytes of the reserve-space buffer.

reserveSpace

Input/Output. Address of the reserve-space buffer in GPU memory.

Returns

CUDNN_STATUS_SUCCESS

No errors were detected while processing API input arguments and launching GPU kernels.

CUDNN_STATUS_NOT_SUPPORTED

The function does not support the provided configuration.

CUDNN_STATUS_BAD_PARAM

An invalid or incompatible input argument was encountered. For example:

- ▶ some input descriptors are NULL
- ▶ settings in `rnnDesc`, `xDesc`, `yDesc`, or `hDesc` descriptors are invalid
- ▶ `weightSpaceSize`, `workSpaceSize`, or `reserveSpaceSize` values are too small

- ▶ the addGrad argument is not equal to CUDNN_WGRAD_MODE_ADD

CUDNN_STATUS_EXECUTION_FAILED

The process of launching a GPU kernel returned an error, or an earlier kernel did not complete successfully.

CUDNN_STATUS_ALLOC_FAILED

The function was unable to allocate CPU memory.

8.2.22. cudnnRNNBackwardWeightsEx ()

This function has been deprecated in cuDNN 8.0. Use [cudnnRNNBackwardWeights_v8\(\)](#) instead of `cudnnRNNBackwardWeightsEX()`.

```

cudnnStatus_t cudnnRNNBackwardWeightsEx(
    cudnnHandle_t          handle,
    const cudnnRNNDescriptor_t    rnnDesc,
    const cudnnRNNDataDescriptor_t xDesc,
    const void             *x,
    const cudnnTensorDescriptor_t hxDesc,
    const void             *hx,
    const cudnnRNNDataDescriptor_t yDesc,
    const void             *y,
    void                   *workSpace,
    size_t                  workSpaceSizeInBytes,
    const cudnnFilterDescriptor_t dwDesc,
    void                   *dw,
    void                   *reserveSpace,
    size_t                  reserveSpaceSizeInBytes)
    
```

This routine is the extended version of the function [cudnnRNNBackwardWeights\(\)](#). This function `cudnnRNNBackwardWeightsEx()` allows the user to use an unpacked (padded) layout for input `x` and output `dw`.

In the unpacked layout, each sequence in the mini-batch is considered to be of fixed length, specified by `maxSeqLength` in its corresponding `RNNDataDescriptor`. Each fixed-length sequence, for example, the `n`th sequence in the mini-batch, is composed of a valid segment specified by the `seqLengthArray[n]` in its corresponding `RNNDataDescriptor`; and a padding segment to make the combined sequence length equal to `maxSeqLength`.

With the unpacked layout, both sequence major (meaning, time major) and batch major are supported. For backward compatibility, the packed sequence major layout is supported. However, similar to the non-extended function [cudnnRNNBackwardWeights\(\)](#), the sequences in the mini-batch need to be sorted in descending order according to length.

Parameters

handle

Input. Handle to a previously created cuDNN context.

rnnDesc

Input. A previously initialized RNN descriptor.

xDesc

Input. A previously initialized RNN data descriptor. Must match or be the exact same descriptor previously passed into [cudaRNNForwardTrainingEx\(\)](#).

x

Input. Data pointer to GPU memory associated with the tensor descriptors in the array `xDesc`. Must contain the exact same data previously passed into [cudaRNNForwardTrainingEx\(\)](#).

hxDesc

Input. A fully packed tensor descriptor describing the initial hidden state of the RNN. Must match or be the exact same descriptor previously passed into [cudaRNNForwardTrainingEx\(\)](#).

hx

Input. Data pointer to GPU memory associated with the tensor descriptor `hxDesc`. If a `NULL` pointer is passed, the initial hidden state of the network will be initialized to zero. Must contain the exact same data previously passed into [cudaRNNForwardTrainingEx\(\)](#), or be `NULL` if `NULL` was previously passed to [cudaRNNForwardTrainingEx\(\)](#).

yDesc

Input. A previously initialized RNN data descriptor. Must match or be the exact same descriptor previously passed into [cudaRNNForwardTrainingEx\(\)](#).

y

Input. Data pointer to GPU memory associated with the output tensor descriptor `yDesc`. Must contain the exact same data previously produced by [cudaRNNForwardTrainingEx\(\)](#).

workspace

Input. Data pointer to GPU memory to be used as a workspace for this call.

workspaceSizeInBytes

Input. Specifies the size in bytes of the provided `workspace`.

dwDesc

Input. Handle to a previously initialized filter descriptor describing the gradients of the weights for the RNN.

dw

Input/Output. Data pointer to GPU memory associated with the filter descriptor `dwDesc`.

reserveSpace

Input. Data pointer to GPU memory to be used as a reserve space for this call.

reserveSpaceSizeInBytes

Input. Specifies the size in bytes of the provided `reserveSpace`.

Returns

CUDNN_STATUS_SUCCESS

The function launched successfully.

CUDNN_STATUS_NOT_SUPPORTED

The function does not support the provided configuration.

CUDNN_STATUS_BAD_PARAM

At least one of the following conditions are met:

- ▶ The descriptor `rnnDesc` is invalid.
- ▶ At least one of the descriptors `xDesc`, `yDesc`, `hxDesc`, `dwDesc` is invalid, or has incorrect strides or dimensions.
- ▶ `workSpaceSizeInBytes` is too small.
- ▶ `reserveSpaceSizeInBytes` is too small.

CUDNN_STATUS_EXECUTION_FAILED

The function failed to launch on the GPU.

CUDNN_STATUS_ALLOC_FAILED

The function was unable to allocate memory.

8.2.23. cudnnRNNForwardTraining()

This function is deprecated starting in cuDNN 8.0.0.

Use [cudnnRNNForward\(\)](#) instead of `cudnnRNNForwardTraining()`.

```

cudnnStatus_t cudnnRNNForwardTraining(
    cudnnHandle_t          handle,
    const cudnnRNNDescriptor_t  rnnDesc,
    const int              seqLength,
    const cudnnTensorDescriptor_t *xDesc,
    const void             *x,
    const cudnnTensorDescriptor_t hxDesc,
    const void             *hx,
    const cudnnTensorDescriptor_t cxDesc,
    const void             *cx,
    const cudnnFilterDescriptor_t wDesc,
    const void             *w,
    const cudnnTensorDescriptor_t *yDesc,
    void                  *y,
    const cudnnTensorDescriptor_t hyDesc,
    void                  *hy,
    const cudnnTensorDescriptor_t cyDesc,
    void                  *cy,
    void                  *workspace,
    size_t                 workSpaceSizeInBytes,
    void                  *reserveSpace,
    size_t                 reserveSpaceSizeInBytes)

```

This routine executes the recurrent neural network described by `rnnDesc` with inputs `x`, `hx`, and `cx`, weights `w` and outputs `y`, `hy`, and `cy`. `workspace` is required for intermediate storage. `reserveSpace` stores data required for training. The same `reserveSpace` data must be used

for future calls to [cudaRNNBackwardData\(\)](#) and [cudaRNNBackwardWeights\(\)](#) if these execute on the same input data.

Parameters

handle

Input. Handle to a previously created cuDNN context.

rnnDesc

Input. A previously initialized RNN descriptor.

seqLength

Input. Number of iterations to unroll over. The value of this `seqLength` must not exceed the value that was used in [cudaGetRNNWorkspaceSize\(\)](#) function for querying the workspace size required to execute the RNN.

xDesc

Input. An array of `seqLength` fully packed tensor descriptors. Each descriptor in the array should have three dimensions that describe the input data format to one recurrent iteration (one descriptor per RNN time-step). The first dimension (batch size) of the tensors may decrease from iteration element `n` to iteration element `n+1` but may not increase. Each tensor descriptor must have the same second dimension (RNN input vector length, `inputSize`). The third dimension of each tensor should be 1. Input vectors are expected to be arranged in the column-major order so strides in `xDesc` should be set as follows:

```
strideA[0]=inputSize, strideA[1]=1, strideA[2]=1
```

x

Input. Data pointer to GPU memory associated with the array of tensor descriptors `xDesc`. The input vectors are expected to be packed contiguously with the first vector of iterations (time-step) `n+1` following directly the last vector of iteration `n`. In other words, input vectors for all RNN time-steps should be packed in the contiguous block of GPU memory with no gaps between the vectors.

hxDesc

Input. A fully packed tensor descriptor describing the initial hidden state of the RNN. The first dimension of the tensor depends on the `direction` argument used to initialize `rnnDesc`:

- ▶ If `direction` is `CUDNN_UNIDIRECTIONAL` the first dimension should match the `numLayers` argument.
- ▶ If `direction` is `CUDNN_BIDIRECTIONAL` the first dimension should match double the `numLayers` argument.

The second dimension must match the first dimension of the tensors described in `xDesc`. The third dimension must match the `hiddenSize` argument used to initialize `rnnDesc`. The tensor must be fully packed.

hx

Input. Data pointer to GPU memory associated with the tensor descriptor `hxDesc`. If a `NULL` pointer is passed, the initial hidden state of the network will be initialized to zero.

cxDesc

Input. A fully packed tensor descriptor describing the initial cell state for LSTM networks. The first dimension of the tensor depends on the `direction` argument used to initialize `rnnDesc`:

- ▶ If `direction` is `CUDNN_UNIDIRECTIONAL` the first dimension should match the `numLayers` argument.
- ▶ If `direction` is `CUDNN_BIDIRECTIONAL` the first dimension should match double the `numLayers` argument.

The second dimension must match the first dimension of the tensors described in `xDesc`. The third dimension must match the `hiddenSize` argument used to initialize `rnnDesc`. The tensor must be fully packed.

cx

Input. Data pointer to GPU memory associated with the tensor descriptor `cxDesc`. If a `NULL` pointer is passed, the initial cell state of the network will be initialized to zero.

wDesc

Input. Handle to a previously initialized filter descriptor describing the weights for the RNN.

w

Input. Data pointer to GPU memory associated with the filter descriptor `wDesc`.

yDesc

Input. An array of fully packed tensor descriptors describing the output from each recurrent iteration (one descriptor per iteration). The second dimension of the tensor depends on the `direction` argument used to initialize `rnnDesc`:

- ▶ If `direction` is `CUDNN_UNIDIRECTIONAL` the second dimension should match the `hiddenSize` argument.
- ▶ If `direction` is `CUDNN_BIDIRECTIONAL` the second dimension should match double the `hiddenSize` argument.

The first dimension of the tensor `n` must match the first dimension of the tensor `n` in `xDesc`.

y

Output. Data pointer to GPU memory associated with the output tensor descriptor `yDesc`.

hyDesc

Input. A fully packed tensor descriptor describing the final hidden state of the RNN. The first dimension of the tensor depends on the `direction` argument used to initialize `rnnDesc`:

- ▶ If `direction` is `CUDNN_UNIDIRECTIONAL` the first dimension should match the `numLayers` argument.
- ▶ If `direction` is `CUDNN_BIDIRECTIONAL` the first dimension should match double the `numLayers` argument.

The second dimension must match the first dimension of the tensors described in `xDesc`. The third dimension must match the `hiddenSize` argument used to initialize `rnnDesc`. The tensor must be fully packed.

hy

Output. Data pointer to GPU memory associated with the tensor descriptor `hyDesc`. If a `NULL` pointer is passed, the final hidden state of the network will not be saved.

cyDesc

Input. A fully packed tensor descriptor describing the final cell state for LSTM networks. The first dimension of the tensor depends on the `direction` argument used to initialize `rnnDesc`:

- ▶ If `direction` is `CUDNN_UNIDIRECTIONAL` the first dimension should match the `numLayers` argument.
- ▶ If `direction` is `CUDNN_BIDIRECTIONAL` the first dimension should match double the `numLayers` argument.

The second dimension must match the first dimension of the tensors described in `xDesc`. The third dimension must match the `hiddenSize` argument used to initialize `rnnDesc`. The tensor must be fully packed.

cy

Output. Data pointer to GPU memory associated with the tensor descriptor `cyDesc`. If a `NULL` pointer is passed, the final cell state of the network will not be saved.

workspace

Input. Data pointer to GPU memory to be used as a workspace for this call.

workSpaceSizeInBytes

Input. Specifies the size in bytes of the provided `workspace`.

reserveSpace

Input/Output. Data pointer to GPU memory to be used as a reserve space for this call.

reserveSpaceSizeInBytes

Input. Specifies the size in bytes of the provided `reserveSpace`.

Returns**CUDNN_STATUS_SUCCESS**

The function launched successfully.

CUDNN_STATUS_BAD_PARAM

At least one of the following conditions are met:

- ▶ The descriptor rnnDesc is invalid.
- ▶ At least one of the descriptors hxDesc, cxDesc, wDesc, hyDesc, cyDesc or one of the descriptors in xDesc, yDesc is invalid.
- ▶ The descriptors in one of xDesc, hxDesc, cxDesc, wDesc, yDesc, hyDesc, cyDesc have incorrect strides or dimensions.
- ▶ workspaceSizeInBytes is too small.
- ▶ reserveSpaceSizeInBytes is too small.

CUDNN_STATUS_INVALID_VALUE

[cudnnSetPersistentRNNPlan\(\)](#) was not called prior to the current function when CUDNN_RNN_ALGO_PERSIST_DYNAMIC was selected in the RNN descriptor.

CUDNN_STATUS_EXECUTION_FAILED

The function failed to launch on the GPU.

CUDNN_STATUS_ALLOC_FAILED

The function was unable to allocate memory.

8.2.24. **cudnnRNNForwardTrainingEx()**

This function has been deprecated starting in cuDNN 8.0. Use [cudnnRNNForward\(\)](#) instead of [cudnnRNNForwardTrainingEx\(\)](#).

```

cudnnStatus_t cudnnRNNForwardTrainingEx(
    cudnnHandle_t             handle,
    const cudnnRNNDescriptor_t rnnDesc,
    const cudnnRNNDataDescriptor_t xDesc,
    const void                *x,
    const cudnnTensorDescriptor_t hxDesc,
    const void                *hx,
    const cudnnTensorDescriptor_t cxDesc,
    const void                *cx,
    const cudnnFilterDescriptor_t wDesc,
    const void                *w,
    const cudnnRNNDataDescriptor_t yDesc,
    void                      *y,
    const cudnnTensorDescriptor_t hyDesc,
    void                      *hy,
    const cudnnTensorDescriptor_t cyDesc,
    void                      *cy,
    const cudnnRNNDataDescriptor_t kDesc,
    const void                *keys,
    const cudnnRNNDataDescriptor_t cDesc,
    void                      *cAttn,
    const cudnnRNNDataDescriptor_t iDesc,
    void                      *iAttn,
    const cudnnRNNDataDescriptor_t qDesc,
    void                      *queries,
    void                      *workspace,
    size_t                   workspaceSizeInBytes,
    void                      *reserveSpace,

```

```
size_t reserveSpaceSizeInBytes);
```

This routine is the extended version of the [cudnnRNNForwardTraining\(\)](#) function. The `cudnnRNNForwardTrainingEx()` allows the user to use unpacked (padded) layout for input x and output y .

In the unpacked layout, each sequence in the mini-batch is considered to be of fixed length, specified by `maxSeqLength` in its corresponding `RNNDataDescriptor`. Each fixed-length sequence, for example, the n th sequence in the mini-batch, is composed of a valid segment specified by the `seqLengthArray[n]` in its corresponding `RNNDataDescriptor`; and a padding segment to make the combined sequence length equal to `maxSeqLength`.

With the unpacked layout, both sequence major (meaning, time major) and batch major are supported. For backward compatibility, the packed sequence major layout is supported. However, similar to the non-extended function [cudnnRNNForwardTraining\(\)](#), the sequences in the mini-batch need to be sorted in descending order according to length.

Parameters

handle

Input. Handle to a previously created cuDNN context.

rnnDesc

Input. A previously initialized RNN descriptor.

xDesc

Input. A previously initialized RNN Data descriptor. The `dataType`, `layout`, `maxSeqLength`, `batchSize`, and `seqLengthArray` need to match that of `yDesc`.

x

Input. Data pointer to the GPU memory associated with the RNN data descriptor `xDesc`. The input vectors are expected to be laid out in memory according to the layout specified by `xDesc`. The elements in the tensor (including elements in the padding vector) must be densely packed, and no strides are supported.

hxDesc

Input. A fully packed tensor descriptor describing the initial hidden state of the RNN.

The first dimension of the tensor depends on the `direction` argument used to initialize `rnnDesc`. Moreover:

- ▶ If `direction` is `CUDNN_UNIDIRECTIONAL` then the first dimension should match the `numLayers` argument.
- ▶ If `direction` is `CUDNN_BIDIRECTIONAL` then the first dimension should match double the `numLayers` argument.

The second dimension must match the `batchSize` parameter in `xDesc`. The third dimension depends on whether RNN mode is `CUDNN_LSTM` and whether LSTM projection is enabled. Additionally:

- ▶ If RNN mode is `CUDNN_LSTM` and LSTM projection is enabled, the third dimension must match the `recProjSize` argument passed to `cudaSetRNNProjectionLayers()` call used to set `rnnDesc`.
- ▶ Otherwise, the third dimension must match the `hiddenSize` argument used to initialize `rnnDesc`.

hx

Input. Data pointer to GPU memory associated with the tensor descriptor `hxDesc`. If a `NULL` pointer is passed, the initial hidden state of the network will be initialized to zero.

cxDesc

Input. A fully packed tensor descriptor describing the initial cell state for LSTM networks.

The first dimension of the tensor depends on the `direction` argument used to initialize `rnnDesc`. Additionally:

- ▶ If `direction` is `CUDNN_UNIDIRECTIONAL` the first dimension should match the `numLayers` argument.
- ▶ If `direction` is `CUDNN_BIDIRECTIONAL` the first dimension should match double the `numLayers` argument.

The second dimension must match the first dimension of the tensors described in `xDesc`. The third dimension must match the `hiddenSize` argument used to initialize `rnnDesc`. The tensor must be fully packed.

cx

Input. Data pointer to GPU memory associated with the tensor descriptor `cxDesc`. If a `NULL` pointer is passed, the initial cell state of the network will be initialized to zero.

wDesc

Input. Handle to a previously initialized filter descriptor describing the weights for the RNN.

w

Input. Data pointer to GPU memory associated with the filter descriptor `wDesc`.

yDesc

Input. A previously initialized RNN data descriptor. The `dataType`, `layout`, `maxSeqLength`, `batchSize`, and `seqLengthArray` need to match that of `dyDesc` and `dxDesc`. The parameter `vectorSize` depends on whether the RNN mode is `CUDNN_LSTM` and whether LSTM projection is enabled and whether the network is bidirectional. Specifically:

- ▶ For a unidirectional network, if the RNN mode is `CUDNN_LSTM` and LSTM projection is enabled, the parameter `vectorSize` must match the `recProjSize` argument passed to `cudaSetRNNProjectionLayers()` call used to set `rnnDesc`. If the network is bidirectional, then multiply the value by 2.

- ▶ Otherwise, for unidirectional network, the parameter `vectorSize` must match the `hiddenSize` argument used to initialize `rnnDesc`. If the network is bidirectional, then multiply the value by 2.

y

Output. Data pointer to GPU memory associated with the RNN data descriptor `yDesc`. The input vectors are expected to be laid out in memory according to the layout specified by `yDesc`. The elements in the tensor (including elements in the padding vector) must be densely packed, and no strides are supported.

hyDesc

Input. A fully packed tensor descriptor describing the final hidden state of the RNN. The descriptor must be set exactly the same as `hxDesc`.

hy

Output. Data pointer to GPU memory associated with the tensor descriptor `hyDesc`. If a `NULL` pointer is passed, the final hidden state of the network will not be saved.

cyDesc

Input. A fully packed tensor descriptor describing the final cell state for LSTM networks. The descriptor must be set exactly the same as `cxDesc`.

cy

Output. Data pointer to GPU memory associated with the tensor descriptor `cyDesc`. If a `NULL` pointer is passed, the final cell state of the network will not be saved.

kDesc

Reserved. Users may pass in `NULL`.

keys

Reserved. Users may pass in `NULL`.

cDesc

Reserved. Users may pass in `NULL`.

cAttn

Reserved. Users may pass in `NULL`.

iDesc

Reserved. Users may pass in `NULL`.

iAttn

Reserved. Users may pass in `NULL`.

qDesc

Reserved. Users may pass in `NULL`.

queries

Reserved. Users may pass in `NULL`.

workspace

Input. Data pointer to GPU memory to be used as a workspace for this call.

workspaceSizeInBytes

Input. Specifies the size in bytes of the provided `workspace`.

reserveSpace

Input/Output. Data pointer to GPU memory to be used as a reserve space for this call.

reserveSpaceSizeInBytes

Input. Specifies the size in bytes of the provided `reserveSpace`.

Returns**CUDNN_STATUS_SUCCESS**

The function launched successfully.

CUDNN_STATUS_NOT_SUPPORTED

At least one of the following conditions are met:

- ▶ Variable sequence length input is passed in while `CUDNN_RNN_ALGO_PERSIST_STATIC` or `CUDNN_RNN_ALGO_PERSIST_DYNAMIC` is used.
- ▶ `CUDNN_RNN_ALGO_PERSIST_STATIC` or `CUDNN_RNN_ALGO_PERSIST_DYNAMIC` is used on pre-Pascal devices.
- ▶ Double input/output is used for `CUDNN_RNN_ALGO_PERSIST_STATIC`.

CUDNN_STATUS_BAD_PARAM

At least one of the following conditions are met:

- ▶ The descriptor `rnnDesc` is invalid.
- ▶ At least one of the descriptors `xDesc`, `yDesc`, `hxDesc`, `cxDesc`, `wDesc`, `hyDesc`, and `cyDesc` is invalid, or have incorrect strides or dimensions.
- ▶ `workspaceSizeInBytes` is too small.
- ▶ `reserveSpaceSizeInBytes` is too small.

CUDNN_STATUS_INVALID_VALUE

[`cudnnSetPersistentRNNPlan\(\)`](#) was not called prior to the current function when `CUDNN_RNN_ALGO_PERSIST_DYNAMIC` was selected in the RNN descriptor.

CUDNN_STATUS_EXECUTION_FAILED

The function failed to launch on the GPU.

CUDNN_STATUS_ALLOC_FAILED

The function was unable to allocate memory.

8.2.25. cudnnSetCTCLossDescriptor()

```

cudnnStatus_t cudnnSetCTCLossDescriptor(
    cudnnCTCLossDescriptor_t    ctcLossDesc,
    cudnnDataType_t             compType)
    
```

This function sets a CTC loss function descriptor. See also the extended version [cudnnSetCTCLossDescriptorEx\(\)](#) to set the input normalization mode.

When the extended version [cudnnSetCTCLossDescriptorEx\(\)](#) is used with `normMode` set to `CUDNN_LOSS_NORMALIZATION_NONE` and the `gradMode` set to `CUDNN_NOT_PROPAGATE_NAN`, then it is the same as the current function `cudnnSetCTCLossDescriptor()`, meaning:

```

cudnnSetCtcLossDescriptor(*) = cudnnSetCtcLossDescriptorEx(*,
    normMode=CUDNN_LOSS_NORMALIZATION_NONE, gradMode=CUDNN_NOT_PROPAGATE_NAN)
    
```

Parameters

ctcLossDesc

Output. CTC loss descriptor to be set.

compType

Input. Compute type for this CTC loss function.

Returns

CUDNN_STATUS_SUCCESS

The function returned successfully.

CUDNN_STATUS_BAD_PARAM

At least one of the input parameters passed is invalid.

8.2.26. cudnnSetCTCLossDescriptorEx()

```

cudnnStatus_t cudnnSetCTCLossDescriptorEx(
    cudnnCTCLossDescriptor_t    ctcLossDesc,
    cudnnDataType_t             compType,
    cudnnLossNormalizationMode_t normMode,
    cudnnNanPropagation_t       gradMode)
    
```

This function is an extension of [cudnnSetCTCLossDescriptor\(\)](#). This function provides an additional interface `normMode` to set the input normalization mode for the CTC loss function, and `gradMode` to control the NaN propagation type.

When this function `cudnnSetCTCLossDescriptorEx()` is used with `normMode` set to `CUDNN_LOSS_NORMALIZATION_NONE` and the `gradMode` set to `CUDNN_NOT_PROPAGATE_NAN`, then it is the same as [cudnnSetCTCLossDescriptor\(\)](#), meaning:

```

cudnnSetCtcLossDescriptor(*) = cudnnSetCtcLossDescriptorEx(*,
    normMode=CUDNN_LOSS_NORMALIZATION_NONE, gradMode=CUDNN_NOT_PROPAGATE_NAN)
    
```

Parameters

ctcLossDesc

Output. CTC loss descriptor to be set.

compType

Input. Compute type for this CTC loss function.

normMode

Input. Input normalization type for this CTC loss function. For more information, see [cudaLossNormalizationMode_t](#).

gradMode

Input. NaN propagation type for this CTC loss function. For L the sequence length, R the number of repeated letters in the sequence, and T the length of sequential data, the following applies: when a sample with $L+R > T$ is encountered during the gradient calculation, if `gradMode` is set to `CUDNN_PROPAGATE_NAN` (see [cudaNanPropagation_t](#)), then the CTC loss function does not write to the gradient buffer for that sample. Instead, the current values, even not finite, are retained. If `gradMode` is set to `CUDNN_NOT_PROPAGATE_NAN`, then the gradient for that sample is set to zero. This guarantees finite gradient.

Returns

CUDNN_STATUS_SUCCESS

The function returned successfully.

CUDNN_STATUS_BAD_PARAM

At least one of the input parameters passed is invalid.

8.2.27. `cudaSetCTCLossDescriptor_v8()`

```

cudaStatus_t cudaSetCTCLossDescriptorEx(
    cudaCTCLossDescriptor_t      ctcLossDesc,
    cudaDataType_t                compType,
    cudaLossNormalizationMode_t  normMode,
    cudaNanPropagation_t         gradMode,
    int                           maxLabelLength)

```

Many CTC API functions are updated in cuDNN version 8.0.0 to support CUDA graphs. In order to do so, a new parameter is needed, `maxLabelLength`. Now that label and input data are assumed to be in GPU memory, this information is not otherwise readily available.

Parameters

ctcLossDesc

Output. CTC loss descriptor to be set.

compType

Input. Compute type for this CTC loss function.

normMode

Input. Input normalization type for this CTC loss function. For more information, see [cudnnLossNormalizationMode_t](#).

gradMode

Input. NaN propagation type for this CTC loss function. For L the sequence length, R the number of repeated letters in the sequence, and T the length of sequential data, the following applies: when a sample with $L+R > T$ is encountered during the gradient calculation, if `gradMode` is set to `CUDNN_PROPAGATE_NAN` (see [cudnnNanPropagation_t](#)), then the CTC loss function does not write to the gradient buffer for that sample. Instead, the current values, even not finite, are retained. If `gradMode` is set to `CUDNN_NOT_PROPAGATE_NAN`, then the gradient for that sample is set to zero. This guarantees finite gradient.

maxLabelLength

Input. The maximum label length from the labels data.

Returns

CUDNN_STATUS_SUCCESS

The function returned successfully.

CUDNN_STATUS_BAD_PARAM

At least one of input parameters passed is invalid.

Chapter 9. cuDNN Backend API

This chapter documents the current implemented behavior of the `cudaBackend*` API introduced in cuDNN version 8.x. Users specify the computational case, set up an execution plan for it, and execute the computation via numerous descriptors. The typical use pattern for a descriptor with attributes consists of the following sequence of API calls:

1. [`cudaBackendCreateDescriptor\(\)`](#) creates a descriptor of a specified type.
2. [`cudaBackendSetAttribute\(\)`](#) sets the values of a settable attribute for the descriptor. All required attributes must be set before the next step.
3. [`cudaBackendFinalize\(\)`](#) finalizes the descriptor.
4. [`cudaBackendGetAttribute\(\)`](#) gets the values of an attribute from a finalized descriptor.

The enumeration type [`cudaBackendDescriptorType_t`](#) enumerates the list of valid cuDNN backend descriptor types. The enumeration type [`cudaBackendAttributeName_t`](#) enumerates the list of valid attributes. Each descriptor type in [`cudaBackendDescriptorType_t`](#) has a disjoint subset of valid attribute values of [`cudaBackendAttributeName_t`](#). The full description of each descriptor type and their attributes are specified in the [Backend Descriptor Types](#) section.

9.1. Data Type References

9.1.1. `cudaBackendAttributeType_t`

```
typedef enum {
    CUDNN_TYPE_HANDLE = 0,
    CUDNN_TYPE_DATA_TYPE,
    CUDNN_TYPE_BOOLEAN,
    CUDNN_TYPE_INT64,
    CUDNN_TYPE_FLOAT,
    CUDNN_TYPE_DOUBLE,
    CUDNN_TYPE_VOID_PTR,
    CUDNN_TYPE_CONVOLUTION_MODE,
    CUDNN_TYPE_HEUR_MODE,
    CUDNN_TYPE_KNOB_TYPE,
    CUDNN_TYPE_NAN_PROPOGATION,
    CUDNN_TYPE_NUMERICAL_NOTE,
    CUDNN_TYPE_ATTRIB_NAME,
    CUDNN_TYPE_POINTWISE_MODE,
    CUDNN_TYPE_BACKEND_DESCRIPTOR,
    CUDNN_TYPE_GENSTATS_MODE
} cudaBackendAttributeType_t;
```

The enumeration type `cudaBackendAttributeType_t` specifies the data type of an attribute of a cuDNN backend descriptor. It is used to specify the type of data pointed to by the void `*arrayOfElements` argument of `cudaBackendSetAttribute()` and `cudaBackendGetAttribute()`.

Table 42. The attribute types of `cudaBackendAttributeType_t`.

<code>cudaBackendAttributeType_t</code>	Attribute type
<code>CUDNN_TYPE_HANDLE</code>	cudaHandle_t
<code>CUDNN_TYPE_DATA_TYPE</code>	cudaDataType_t
<code>CUDNN_TYPE_BOOLEAN</code>	<code>bool</code>
<code>CUDNN_TYPE_INT64</code>	<code>int64_t</code>
<code>CUDNN_TYPE_FLOAT</code>	<code>float</code>
<code>CUDNN_TYPE_DOUBLE</code>	<code>double</code>
<code>CUDNN_TYPE_VOID_PTR</code>	<code>void *</code>
<code>CUDNN_TYPE_CONVOLUTION_MODE</code>	cudaConvolutionMode_t
<code>CUDNN_TYPE_HEUR_MODE</code>	cudaBackendHeurMode_t
<code>CUDNN_TYPE_KNOB_TYPE</code>	cudaBackendKnobType_t
<code>CUDNN_TYPE_NAN_PROPOGATION</code>	cudaNanPropagation_t
<code>CUDNN_TYPE_NUMERICAL_NOTE</code>	cudaBackendNumericalNote_t
<code>CUDNN_TYPE_ATTRIB_NAME</code>	cudaBackendAttributeName_t
<code>CUDNN_TYPE_POINTWISE_MODE</code>	cudaPointwiseMode_t
<code>CUDNN_TYPE_BACKEND_DESCRIPTOR</code>	cudaBackendDescriptor_t
<code>CUDNN_TYPE_GENSTATS_MODE</code>	cudaGenStatsMode_t

9.2. Backend Descriptor Types

This section enumerates all valid attributes of various descriptors.

9.2.1. CUDNN_BACKEND_CONVOLUTION_DESCRIPTOR

Created with `cudaBackendCreate(CUDNN_BACKEND_CONVOLUTION_DESCRIPTOR, &desc)`; the cuDNN backend convolution descriptor specifies the parameters for a convolution operator for both forward and backward propagation: compute data type, convolution mode, filter dilation and stride, and padding on both sides.

Attributes

Attributes of a cuDNN backend convolution descriptor are values of enumeration type [cudaBackendAttributeName_t](#) with prefix `CUDNN_ATTR_CONVOLUTION_`:

CUDNN_ATTR_CONVOLUTION_COMP_TYPE

The compute type of the convolution operator.

- ▶ `CUDNN_TYPE_DATA_TYPE`; one element.
- ▶ Required attribute.

CUDNN_ATTR_CONVOLUTION_MODE

Convolution or cross-correlation mode.

- ▶ `CUDNN_TYPE_CONVOLUTION_MODE`; one element.
- ▶ Required attribute.

CUDNN_ATTR_CONVOLUTION_DILATIONS

Filter dilation.

- ▶ `CUDNN_TYPE_INT64`; one or more, but at most `CUDNN_MAX_DIMS` elements.
- ▶ Required attribute.

CUDNN_ATTR_CONVOLUTION_FILTER_STRIDES

Filter stride.

- ▶ `CUDNN_TYPE_INT64`; one or more, but at most `CUDNN_MAX_DIMS` elements.
- ▶ Required attribute.

CUDNN_ATTR_CONVOLUTION_PRE_PADDINGS

Padding at the beginning of each spatial dimension.

- ▶ `CUDNN_TYPE_INT64`; one or more, but at most `CUDNN_MAX_DIMS` elements.
- ▶ Required attribute.

CUDNN_ATTR_CONVOLUTION_POST_PADDINGS

Padding at the end of each spatial dimension.

- ▶ `CUDNN_TYPE_INT64`; one or more, but at most `CUDNN_MAX_DIMS` elements.
- ▶ Required attribute.

Finalization

[`cudaBackendFinalize\(\)`](#) with a `CUDNN_BACKEND_CONVOLUTION_DESCRIPTOR` can have the following return values:

CUDNN_STATUS_BAD_PARAM

An `elemCount` argument for setting `CUDNN_ATTR_CONVOLUTION_DILATIONS`, `CUDNN_ATTR_CONVOLUTION_FILTER_STRIDES`, `CUDNN_ATTR_CONVOLUTION_PRE_PADDINGS`, and `CUDNN_ATTR_CONVOLUTION_POST_PADDINGS` is not equal to the value set for `CUDNN_ATTR_CONVOLUTION_SPATIAL_DIMS`.

CUDNN_STATUS_SUCCESS

The descriptor was finalized successfully.

9.2.2. CUDNN_BACKEND_ENGINE_DESCRIPTOR

Created with descriptor type value `CUDNN_BACKEND_ENGINE_DESCRIPTOR`, cuDNN backend engine descriptor describes an engine to compute an operation graph. An engine is a grouping of kernels with similar compute and numerical attributes.

Attributes

Attributes of a cuDNN backend convolution descriptor are values of enumeration type `cudaBackendAttributeName_t` with prefix `CUDNN_ATTR_ENGINE_`:

CUDNN_ATTR_ENGINE_OPERATION_GRAPH

The operation graph to compute.

- ▶ `CUDNN_TYPE_BACKEND_DESCRIPTOR`; one element of descriptor type `CUDNN_BACKEND_OPERATIONGRAPH_DESCRIPTOR`.
- ▶ Required attribute.

CUDNN_ATTR_ENGINE_GLOBAL_INDEX

The index for the engine.

- ▶ `CUDNN_TYPE_INT64`; one element.
- ▶ Valid values are between 0 and `CUDNN_ATTR_OPERATIONGRAPH_ENGINE_GLOBAL_COUNT-1`.
- ▶ Required attribute.

CUDNN_ATTR_ENGINE_KNOB_INFO

The descriptors of performance knobs of the engine.

- ▶ `CUDNN_TYPE_BACKEND_DESCRIPTOR`; one element of descriptor type `CUDNN_BACKEND_KNOB_INFO_DESCRIPTOR`.
- ▶ Read-only attribute.

CUDNN_ATTR_ENGINE_NUMERICAL_NOTE

The numerical attributes of the engine.

- ▶ `CUDNN_TYPE_NUMERICAL_NOTE`; zero or more elements.
- ▶ Read-only attribute.

CUDNN_ATTR_ENGINE_LAYOUT_INFO

The preferred tensor layouts of the engine.

- ▶ `CUDNN_TYPE_BACKEND_DESCRIPTOR`; one element of descriptor type `CUDNN_BACKEND_LAYOUT_INFO_DESCRIPTOR`.
- ▶ Read-only attribute.

Finalization

CUDNN_STATUS_SUCCESS

The descriptor was finalized successfully.

CUDNN_STATUS_NOT_SUPPORTED

The descriptor attributes set is not supported by the current version of cuDNN. Some examples include:

- ▶ The value of `CUDNN_ATTR_ENGINE_GLOBAL_INDEX` is not in a valid range.

CUDNN_STATUS_BAD_PARAM

The descriptor attributes set is inconsistent or in an unexpected state. Some examples include:

- ▶ The operation graph descriptor set is not already finalized.

9.2.3. CUDNN_BACKEND_ENGINECFG_DESCRIPTOR

Created with `cudaBackendCreate(CUDNN_BACKEND_ENGINECFG_DESCRIPTOR, &desc)`; the cuDNN backend engine configuration descriptor consists of an engine descriptor and an array of knob choice descriptors. Users can query from engine config information about intermediates: computational intermediate results that can be reused between executions.

Attributes

CUDNN_ATTR_ENGINECFG_ENGINE

The backend engine.

- ▶ `CUDNN_TYPE_BACKEND_DESCRIPTOR`: one element, a backend descriptor of type `CUDNN_BACKEND_ENGINE_DESCRIPTOR`.
- ▶ Required attribute.

CUDNN_ATTR_ENGINECFG_KNOB_CHOICES

The engine tuning knobs and choices.

- ▶ `CUDNN_TYPE_BACKEND_DESCRIPTOR`: zero or more elements, backend descriptors of type `CUDNN_BACKEND_KNOB_CHOICE_DESCRIPTOR`.
- ▶ Required attribute.

CUDNN_ATTR_ENGINECFG_INTERMEDIATE_INFO

Information of the computational intermediate of this engine config.

- ▶ `CUDNN_TYPE_BACKEND_DESCRIPTOR`: one element, a backend descriptor of type `CUDNN_BACKEND_INTERMEDIATE_INFO_DESCRIPTOR`.
- ▶ Read-only attribute.

- ▶ Currently unsupported. Placeholder for future implementation.

Finalization

CUDNN_STATUS_SUCCESS

The descriptor was finalized successfully.

CUDNN_STATUS_NOT_SUPPORTED

The descriptor attributes set is not supported by the current version of cuDNN. Some examples include:

- ▶ The value knob.

9.2.4. CUDNN_BACKEND_ENGINEHEUR_DESCRIPTOR

Created with `cudaBackendCreate(CUDNN_BACKEND_ENGINEHEUR_DESCRIPTOR, &desc)`; the cuDNN backend engine heuristics descriptor allows users to obtain for an operation graph engine configuration descriptors ranked by performance according to cuDNN's heuristics.

Attributes

CUDNN_ATTR_ENGINEHEUR_OPERATION_GRAPH

The operation graph for which heuristics result in a query.

CUDNN_TYPE_BACKEND_DESCRIPTOR

One element.

- ▶ Required attribute.

CUDNN_ATTR_ENGINEHEUR_MODE

The heuristic mode to query the result.

- ▶ `CUDNN_TYPE_HEUR_MODE`; one element.
- ▶ Required attribute.

CUDNN_ATTR_ENGINEHEUR_RESULTS

The result of the heuristics query.

- ▶ `CUDNN_TYPE_BACKEND_DESCRIPTOR`; zero or more elements of descriptor type `CUDNN_BACKEND_ENGINECFG_DESCRIPTOR`.
- ▶ Get-only attribute.

Finalization

Return values of `cudaBackendFinalize(desc)` where `desc` is a cuDNN backend engine heuristics descriptor:

CUDNN_STATUS_SUCCESS

The descriptor was finalized successfully.

9.2.5. CUDNN_BACKEND_EXECUTION_PLAN_DESCRIPTOR

Created with `cudaBackendCreate(CUDNN_BACKEND_EXECUTION_PLAN_DESCRIPTOR, &desc)`; the cuDNN backend execution plan descriptor allows the user to specify an execution plan, consists of a cuDNN handle, an engine configuration, and optionally an array of intermediates to compute.

Attributes**CUDNN_ATTR_EXECUTION_PLAN_HANDLE**

A cuDNN handle.

- ▶ `CUDNN_TYPE_HANDLE`; one element.
- ▶ Required attribute.

CUDNN_ATTR_EXECUTION_PLAN_ENGINE_CONFIG

An engine configuration to execute.

- ▶ `CUDNN_BACKEND_ENGINECFG_DESCRIPTOR`; one element.
- ▶ Required attribute.

CUDNN_ATTR_EXECUTION_PLAN_RUN_ONLY_INTERMEDIATE_UIDS

Unique identifiers of intermediates to compute.

- ▶ `CUDNN_TYPE_INT64`; zero or more elements.
- ▶ Optional attribute. If set, the execution plan will only compute the specified intermediate and not any of the output tensors on the operation graph in the engine configuration.

CUDNN_ATTR_EXECUTION_PLAN_COMPUTED_INTERMEDIATE_UIDS

Unique identifiers of precomputed intermediates.

- ▶ `CUDNN_TYPE_INT64`; zero or more elements.
- ▶ Optional attribute. If set, the plan will expect and use pointers for each intermediate in the variant pack descriptor during execution.
- ▶ Not supported currently: placeholder for future implementation.

CUDNN_ATTR_EXECUTION_PLAN_WORKSPACE_SIZE

The size of the workspace buffer required to execute this plan.

- ▶ `CUDNN_TYPE_INT64`; one element.
- ▶ Read-only attribute.

Finalization

Return values of `cudaBackendFinalize(desc)` where `desc` is a cuDNN backend execution plan descriptor:

CUDNN_STATUS_SUCCESS

The descriptor was finalized successfully.

9.2.6. CUDNN_BACKEND_INTERMEDIATE_INFO_DESCRIPTOR

Created with `cudaBackendCreate(CUDNN_BACKEND_INTERMEDIATE_INFO_DESCRIPTOR, &desc)`; the cuDNN backend intermediate descriptor is a read-only descriptor that contains information about an execution intermediate. An execution intermediate is some intermediate computation for an engine config in device memory that can be reused between plan execution to amortize the kernel. Each intermediate is identified by a unique ID. Users can query for the device memory size of the intermediate. An intermediate can depend on the data of one or more tensors identified by the tensor UIDs or one more attributes of the operation graph.

This is a read-only descriptor. Users cannot set the descriptor attributes or finalize the descriptor. User query for a finalized descriptor from an engine config descriptor.

Attributes

CUDNN_ATTR_INTERMEDIATE_INFO_UNIQUE_ID

A unique identifier of the intermediate.

- ▶ `CUDNN_TYPE_INT64`; one element.
- ▶ Read-only attribute.

CUDNN_ATTR_INTERMEDIATE_INFO_SIZE

The required device memory size for the intermediate.

- ▶ `CUDNN_TYPE_INT64`; one element.
- ▶ Read-only attribute.

CUDNN_ATTR_INTERMEDIATE_INFO_DEPENDENT_DATA_UIDS

UID of tensors on which the intermediate depends.

- ▶ `CUDNN_TYPE_INT64`; zero or more elements.
- ▶ Read-only attribute.

CUDNN_ATTR_INTERMEDIATE_INFO_DEPENDENT_ATTRIBUTES

Placeholder for future implementation.

Finalization

User does not finalize this descriptor. `cudaBackendFinalize(desc)` with a backend intermediate descriptor returns `CUDNN_STATUS_NOT_SUPPORTED`.

9.2.7. CUDNN_BACKEND_KNOB_CHOICE_DESCRIPTOR

Created with `cudaBackendCreate(CUDNN_BACKEND_KNOB_CHOICE_DESCRIPTOR, &desc)`; the cuDNN backend knob choice descriptor consists of the type of knobs to be set and the value to which the knob is set.

Attributes

CUDNN_ATTR_KNOB_CHOICE_KNOB_TYPE

The type of knobs to be set.

- ▶ CUDNN_TYPE_KNOB_TYPE: one element.
- ▶ Required attribute.

CUDNN_ATTR_KNOB_CHOICE_KNOB_VALUE

- ▶ CUDNN_TYPE_INT64: one element.
- ▶ Required attribute.

Finalization

Return values of `cudaBackendFinalize(desc)` where `desc` is a cuDNN backend knob choice descriptor:

CUDNN_STATUS_SUCCESS

The knob choice descriptor was finalized successfully.

9.2.8. CUDNN_BACKEND_KNOB_INFO_DESCRIPTOR

Created with `cudaBackendCreate(CUDNN_BACKEND_INFO_DESCRIPTOR, &desc)`; the cuDNN backend knob info descriptor consists of the type and valid value range of an engine performance knob. Valid value range is given in terms of minimum, maximum, and stride of valid values. This is a purely informative descriptor type. Setting descriptor attributes is not supported. User obtains an array of finalized descriptors, one for each knob type, from a finalized backend descriptor.

Attributes

CUDNN_ATTR_KNOB_INFO_TYPE

The type of the performance knob.

- ▶ CUDNN_TYPE_KNOB_TYPE: one element.
- ▶ Read-only attribute.

CUDNN_ATTR_KNOB_INFO_MAXIMUM_VALUE

The smallest valid value choice value for this knob.

- ▶ CUDNN_TYPE_INT64: one element.

- ▶ Read-only attribute.

CUDNN_ATTR_KNOB_INFO_MINIMUM_VALUE

The largest valid choice value for this knob.

- ▶ CUDNN_TYPE_INT64: one element.
- ▶ Read-only attribute.

CUDNN_ATTR_KNOB_INFO_STRIDE

The stride of valid choice values for this knob.

- ▶ CUDNN_TYPE_INT64: one element.
- ▶ Read-only attribute.

Finalization

This descriptor is read-only; it is retrieved finalized from a cuDNN backend engine configuration descriptor. Users cannot set or finalize.

9.2.9. CUDNN_BACKEND_LAYOUT_INFO_DESCRIPTOR

Created with descriptor type value CUDNN_BACKEND_LAYOUT_INFO_DESCRIPTOR, cuDNN backend layout info descriptor provides information on the preferred layout for a tensor.

Attributes

CUDNN_ATTR_LAYOUT_INFO_TENSOR_UID

The UID of the tensor.

- ▶ CUDNN_TYPE_INT64; one element.
- ▶ Read-only attribute.

CUDNN_ATTR_LAYOUT_INFO_TYPES

The preferred layout of the tensor.

- ▶ CUDNN_TYPE_LAYOUT_TYPE: zero or more element [`cudaBackendLayoutType_t`](#).
- ▶ Read-only attribute.

Finalization

This descriptor is read-only; it is retrieved finalized from a cuDNN backend engine configuration descriptor. Users cannot set its attribute or finalize it.

9.2.10. CUDNN_BACKEND_OPERATION_CONVOLUTION_BACKWARD

Created with

`cudaBackendCreate(CUDNN_BACKEND_OPERATION_CONVOLUTION_BACKWARD_DATA_DESCRIPTOR, &desc)`; the cuDNN backend convolution backward data operation descriptor specifies an

operation node for convolution backward data to compute the gradient of input data \mathbf{dx} with filter tensor w and gradient of response \mathbf{dy} with output α scaling and residue add with β scaling. That is, the equation $\mathbf{dx} = \alpha(w * \mathbf{dy}) + \beta \mathbf{dx}$, where $*$ denotes the convolution backward data operator.

Attributes

Attributes of a cuDNN backend convolution descriptor are values of enumeration type `cudaDnnBackendAttributeName_t` with prefix

`CUDNN_ATTR_OPERATION_CONVOLUTION_BWD_DATA_`:

CUDNN_ATTR_OPERATION_CONVOLUTION_BWD_DATA_ALPHA

The alpha value.

- ▶ `CUDNN_TYPE_FLOAT` or `CUDNN_TYPE_DOUBLE`; one or more elements.
- ▶ Required attribute.

CUDNN_ATTR_OPERATION_CONVOLUTION_BWD_DATA_BETA

The beta value.

- ▶ `CUDNN_TYPE_FLOAT` or `CUDNN_TYPE_DOUBLE`; one or more elements.
- ▶ Required attribute.

CUDNN_ATTR_OPERATION_CONVOLUTION_BWD_DATA_CONV_DESC

The convolution operator descriptor.

- ▶ `CUDNN_TYPE_BACKEND_DESCRIPTOR`; one element of descriptor type `CUDNN_BACKEND_CONVOLUTION_DESCRIPTOR`.
- ▶ Required attribute.

CUDNN_ATTR_OPERATION_CONVOLUTION_BWD_DATA_W

The convolution filter tensor descriptor.

- ▶ `CUDNN_TYPE_BACKEND_DESCRIPTOR`; one element of descriptor type `CUDNN_BACKEND_TENSOR_DESCRIPTOR`.
- ▶ Required attribute.

CUDNN_ATTR_OPERATION_CONVOLUTION_BWD_DATA_DX

The image gradient tensor descriptor.

- ▶ `CUDNN_TYPE_BACKEND_DESCRIPTOR`; one element of descriptor type `CUDNN_BACKEND_TENSOR_DESCRIPTOR`.
- ▶ Required attribute.

CUDNN_ATTR_OPERATION_CONVOLUTION_BWD_DATA_DY

The response gradient tensor descriptor.

- ▶ CUDNN_TYPE_BACKEND_DESCRIPTOR; one element of descriptor type CUDNN_BACKEND_TENSOR_DESCRIPTOR.
- ▶ Required attribute.

Finalization

In finalizing the convolution operation, the tensor dimensions of the tensor DX , w , and DY are bound based on the same interpretations as the x , w , and y tensor dimensions described in the [CUDNN_BACKEND_OPERATION_CONVOLUTION_FORWARD_DESCRIPTOR](#) section.

`cudaBackendFinalize()` with a

CUDNN_BACKEND_OPERATION_CONVOLUTION_BACKWARD_DATA_DESCRIPTOR() can have the following return values:

CUDNN_STATUS_BAD_PARAM

Invalid or inconsistent attribute values are encountered. Some possible cause:

- ▶ The DX , w , and DY tensors do not constitute a valid convolution operation under the convolution operator.

CUDNN_STATUS_SUCCESS

The descriptor was finalized successfully.

9.2.11. CUDNN_BACKEND_OPERATION_CONVOLUTION_BACKWARD_FILTER_DESCRIPTOR

Created with

`cudaBackendCreate(CUDNN_BACKEND_OPERATION_CONVOLUTION_BACKWARD_FILTER_DESCRIPTOR, &desc)`; the cuDNN backend convolution backward filter operation descriptor specifies an operation node for convolution backward filter to compute the gradient of filter dw with image tensor x and gradient of response dy with output α scaling and residue add with β scaling.

That is, the equation: $dw = \alpha(x \tilde{*} dy) + \beta dw$, where $\tilde{*}$ denotes the convolution backward filter operator.

Attributes

Attributes of a cuDNN backend convolution descriptor are values of enumeration type `cudaBackendAttributeName_t` with prefix

CUDNN_ATTR_OPERATION_CONVOLUTION_BWD_FILTER_:

CUDNN_ATTR_OPERATION_CONVOLUTION_BWD_FILTER_ALPHA

The alpha value.

- ▶ CUDNN_TYPE_FLOAT or CUDNN_TYPE_DOUBLE; one or more elements.
- ▶ Required attribute. Required to be set before finalization.

CUDNN_ATTR_OPERATION_CONVOLUTION_BWD_FILTER_BETA

The beta value.

- ▶ CUDNN_TYPE_FLOAT or CUDNN_TYPE_DOUBLE; one or more elements.

- ▶ Required attribute. Required to be set before finalization.

CUDNN_ATTR_OPERATION_CONVOLUTION_BWD_FILTER_CONV_DESC

The convolution operator descriptor.

- ▶ CUDNN_TYPE_BACKEND_DESCRIPTOR; one element of descriptor type CUDNN_BACKEND_CONVOLUTION_DESCRIPTOR.
- ▶ Required attribute. Required to be set before finalization.

CUDNN_ATTR_OPERATION_CONVOLUTION_BWD_FILTER_DW

The convolution filter tensor descriptor.

- ▶ CUDNN_TYPE_BACKEND_DESCRIPTOR; one element of descriptor type CUDNN_BACKEND_TENSOR_DESCRIPTOR.
- ▶ Required attribute. Required to be set before finalization.

CUDNN_ATTR_OPERATION_CONVOLUTION_BWD_FILTER_X

The image gradient tensor descriptor.

- ▶ CUDNN_TYPE_BACKEND_DESCRIPTOR; one element of descriptor type CUDNN_BACKEND_TENSOR_DESCRIPTOR.
- ▶ Required attribute. Required to be set before finalization.

CUDNN_ATTR_OPERATION_CONVOLUTION_BWD_FILTER_DY

The response gradient tensor descriptor.

- ▶ CUDNN_TYPE_BACKEND_DESCRIPTOR; one element of descriptor type CUDNN_BACKEND_TENSOR_DESCRIPTOR.
- ▶ Required attribute. Required to be set before finalization.

Finalization

In finalizing the convolution operation, the tensor dimensions of the tensor x , DW , and DY are bound based on the same interpretations as the x , w , and y tensor dimensions described in the [CUDNN_BACKEND_OPERATION_CONVOLUTION_FORWARD_DESCRIPTOR](#) section.

[cudnnBackendFinalize\(\)](#) with a

CUDNN_BACKEND_OPERATION_CONVOLUTION_BACKWARD_FILTER_DESCRIPTOR() can have the following return values:

CUDNN_STATUS_BAD_PARAM

Invalid or inconsistent attribute values are encountered. Some possible cause:

- ▶ The x , DW , and DY tensors do not constitute a valid convolution operation under the convolution operator.

CUDNN_STATUS_SUCCESS

The descriptor was finalized successfully.

9.2.12. CUDNN_BACKEND_OPERATION_CONVOLUTION_FORWARD_

Created with

`cudaDnnBackendCreate(CUDNN_BACKEND_OPERATION_CONVOLUTION_FORWARD_DESCRIPTOR, &desc)`; the cuDNN backend convolution forward operation descriptor specifies an operation node for forward convolution to compute the response tensor y of image tensor x convoluted with filter tensor w with output scaling α and residual add with β scaling. That is, the equation $y = \alpha(w*x) + \beta y$, where $*$ is the convolution operator in the forward direction.

Attributes

Attributes of a cuDNN backend convolution descriptor are values of enumeration type `cudaDnnBackendAttributeName_t` with prefix `CUDNN_ATTR_OPERATION_CONVOLUTION_FORWARD_`:

CUDNN_ATTR_OPERATION_CONVOLUTION_FORWARD_ALPHA

The alpha value.

- ▶ `CUDNN_TYPE_FLOAT` or `CUDNN_TYPE_DOUBLE`; one or more elements.
- ▶ Required to be set before finalization.

CUDNN_ATTR_OPERATION_CONVOLUTION_FORWARD_BETA

The beta value.

- ▶ `CUDNN_TYPE_FLOAT` or `CUDNN_TYPE_DOUBLE`; one or more elements.
- ▶ Required attribute.

CUDNN_ATTR_OPERATION_CONVOLUTION_FORWARD_CONV_DESC

The convolution operator descriptor.

- ▶ `CUDNN_TYPE_BACKEND_DESCRIPTOR`; one element of descriptor type `CUDNN_BACKEND_CONVOLUTION_DESCRIPTOR`.
- ▶ Required attribute.

CUDNN_ATTR_OPERATION_CONVOLUTION_FORWARD_W

The convolution filter tensor descriptor.

- ▶ `CUDNN_TYPE_BACKEND_DESCRIPTOR`; one element of descriptor type `CUDNN_BACKEND_TENSOR_DESCRIPTOR`.
- ▶ Required attribute.

CUDNN_ATTR_OPERATION_CONVOLUTION_FORWARD_X

The image tensor descriptor.

- ▶ `CUDNN_TYPE_BACKEND_DESCRIPTOR`; one element of descriptor type `CUDNN_BACKEND_TENSOR_DESCRIPTOR`.
- ▶ Required attribute.

CUDNN_ATTR_OPERATION_CONVOLUTION_FORWARD_Y

The response tensor descriptor.

- ▶ CUDNN_TYPE_BACKEND_DESCRIPTOR; one element of descriptor type CUDNN_BACKEND_TENSOR_DESCRIPTOR.
- ▶ Required attribute.

Finalization

In finalizing the convolution operation, the tensor dimensions of the tensor x , w , and y are bound based on the following interpretations:

The CUDNN_ATTR_CONVOLUTION_SPATIAL_DIMS attribute of CUDNN_ATTR_OPERATION_CONVOLUTION_FORWARD_CONV_DESC is the number of spatial dimension of the convolution. The number of dimensions for tensor x , w , and y must be larger than the number of spatial dimensions by 2 or 3 depending on how users choose to specify the convolution tensors.

If the number of tensor dimension is the number of spatial dimensions plus 2:

- ▶ x tensor dimension and stride arrays are $[N, G, C, \dots]$
- ▶ w tensor dimension and stride arrays are $[K, G, C, \dots]$
- ▶ y tensor dimension and stride arrays are $[N, G, K, \dots]$

where the ellipsis \dots are shorthand for spatial dimensions of each tensor, G is the number of convolution groups, and C and K are the number of input and output feature maps per group. In this interpretation, it is assumed that the memory layout for each group is packed. [`cudaBackendFinalize\(\)`](#) asserts the tensors dimensions and strides are consistent with this interpretation or it returns CUDNN_STATUS_BAD_PARAM.

If the number of tensor dimension is the number of spatial dimensions plus 3:

- ▶ x tensor dimension and stride arrays are $[N, G, C, \dots]$
- ▶ w tensor dimension and stride arrays are $[G, K, C, \dots]$
- ▶ y tensor dimension and stride arrays are $[N, G, K, \dots]$

where the ellipsis \dots are shorthand for spatial dimensions of each tensor, G is the number of convolution groups, and C and K are the number of input and output feature maps per group. In this interpretation, users can specify unpacked group stride. [`cudaBackendFinalize\(\)`](#) asserts the tensors dimensions and strides are consistent with this interpretation or it returns CUDNN_STATUS_BAD_PARAM.

[`cudaBackendFinalize\(\)`](#) with a

CUDNN_BACKEND_OPERATION_CONVOLUTION_FORWARD_DESCRIPTOR can have the following return values:

CUDNN_STATUS_BAD_PARAM

Invalid or inconsistent attribute values are encountered. Some possible cause:

- ▶ The x , w , and y tensors do not constitute a valid convolution operation under the convolution operator.

CUDNN_STATUS_SUCCESS

The descriptor was finalized successfully.

9.2.13. CUDNN_BACKEND_OPERATION_GEN_STATS_DESCRIPTOR

Represents an operation that will generate per-channel statistics. The specific statistics that will be generated depends on the `CUDNN_ATTR_OPERATION_GENSTATS_MODE` attribute in the descriptor. Currently, only `CUDNN_GENSTATS_SUM_SQSUM` is supported for the `CUDNN_ATTR_OPERATION_GENSTATS_MODE`. It will generate sum and quadratic sum of per-channel elements of the input tensor x . The output dimension should be all 1 except c dimension. Also, the c dimension of outputs should equal the c dimension of the input. This opaque struct can be created with `cudaBackendCreate()` (`CUDNN_BACKEND_OPERATION_GEN_STATS_DESCRIPTOR`).

Attributes

CUDNN_ATTR_OPERATION_GENSTATS_MODE

Sets the `CUDNN_TYPE_GENSTATS_MODE` of the operation. This attribute is required.

CUDNN_ATTR_OPERATION_GENSTATS_MATH_PREC

The math precision of the computation. This attribute is required.

CUDNN_ATTR_OPERATION_GENSTATS_XDESC

Sets the descriptor for the input tensor x . This attribute is required.

CUDNN_ATTR_OPERATION_GENSTATS_SUMDESC

Sets the descriptor for the output tensor `sum`. This attribute is required.

CUDNN_ATTR_OPERATION_GENSTATS_SQSUMDESC

Sets the descriptor for the output tensor `quadraticsum`. This attribute is required.

Finalization

In the finalization stage, the attributes are cross checked to make sure there are no conflicts. The status below may be returned:

CUDNN_STATUS_BAD_PARAM

Invalid or inconsistent attribute values are encountered. Some possible causes are:

- ▶ The number of dimensions do not match between the input and output tensors.
- ▶ The input/output tensor dimensions do not agree with the above description.

CUDNN_STATUS_SUCCESS

The descriptor was finalized successfully.

9.2.14. CUDNN_BACKEND_OPERATION_POINTWISE_DESCRIPTOR

Represents a pointwise operation that implements the equation

$Y = \text{op}(\alpha_1 * X)$ or $Y = \text{op}(\alpha_1 * X, \alpha_2 * B)$ depending on the operation

type. The actual type of operation represented by `op()` above depends on the

`CUDNN_ATTR_OPERATION_POINTWISE_PW_DESCRIPTOR` attribute in the descriptor. This

operation descriptor supports operations with either single input single output such as

`CUDNN_POINTWISE_SQRT`, `CUDNN_POINTWISE_RELU_FWD`, `CUDNN_POINTWISE_TANH_FWD`,

`CUDNN_POINTWISE_SIGMOID_FWD`, and `CUDNN_POINTWISE_ELU_FWD`, or dual inputs single

output, such as `CUDNN_POINTWISE_ADD`, `CUDNN_POINTWISE_MUL`, `CUDNN_POINTWISE_MIN`,

`CUDNN_POINTWISE_MAX`. In the latter case, broadcasting is assumed when the corresponding

tensor dimension in one of the tensors is 1 while the other tensors corresponding

dimension is not 1. This opaque struct can be created with `cudaBackendCreate()`

(`CUDNN_BACKEND_OPERATION_POINTWISE_DESCRIPTOR`).

Attributes

CUDNN_ATTR_OPERATION_POINTWISE_PW_DESCRIPTOR

Sets the descriptor containing the mathematical settings of the pointwise operation. This attribute is required.

CUDNN_ATTR_OPERATION_POINTWISE_XDESC

Sets the descriptor for the input tensor X . This attribute is required.

CUDNN_ATTR_OPERATION_POINTWISE_BDESC

If the operation requires 2 inputs, such as add or multiply, this attribute sets the second input tensor B . If the operation requires only 1 input, this field is not used and should not be set.

CUDNN_ATTR_OPERATION_POINTWISE_YDESC

Sets the descriptor for the output tensor Y . This attribute is required.

CUDNN_ATTR_OPERATION_POINTWISE_ALPHA1

Sets the scalar `alpha1` value in the equation. Can be in float or half. This attribute is optional, if not set, the default value is 1.0.

CUDNN_ATTR_OPERATION_POINTWISE_ALPHA2

If the operation requires 2 inputs, such as add or multiply, this attribute sets the scalar `alpha2` value in the equation. Can be in float or half. This attribute is optional, if not set, the default value is 1.0. If the operation requires only 1 input, this field is not used and should not be set.

Finalization

In the finalization stage, the attributes are cross checked to make sure there are no conflicts.

The status below may be returned:

CUDNN_STATUS_BAD_PARAM

Invalid or inconsistent attribute values are encountered. Some possible causes are:

- ▶ The number of dimensions do not match between the input and output tensors.
- ▶ The input/output tensor dimensions do not agree with the above described automatic broadcasting rules.

CUDNN_STATUS_SUCCESS

The descriptor was finalized successfully.

9.2.15. CUDNN_BACKEND_OPERATIONGRAPH_DESCRIPTOR

Created with descriptor type value `CUDNN_BACKEND_OPERATIONGRAPH_DESCRIPTOR`, cuDNN backend operation graph descriptor describes an operation graph, a small network of one or more operations connected by virtual tensors. Operation graph defines users' computation case or mathematical expression that they wish to compute.

Attributes

Attributes of a cuDNN backend convolution descriptor are values of enumeration type `cudaBackendAttributeName_t` with prefix `CUDNN_ATTR_OPERATIONGRAPH_`:

CUDNN_ATTR_OPERATIONGRAPH_HANDLE

A cuDNN handle.

- ▶ `CUDNN_TYPE_DATA_TYPE`; one element.
- ▶ Required attribute.

CUDNN_ATTR_OPERATIONGRAPH_OPS

Operation nodes to form the operation graph.

- ▶ `CUDNN_TYPE_BACKEND_DESCRIPTOR`; one or more elements of descriptor type `CUDNN_BACKEND_OPERATION_*_DESCRIPTOR()`.
- ▶ Required attribute.

CUDNN_ATTR_OPERATIONGRAPH_ENGINE_GLOBAL_COUNT

The number of engines to support the operation graph.

- ▶ `CUDNN_TYPE_INT64`; one element.
- ▶ Read-only attribute.

CUDNN_ATTR_OPERATIONGRAPH_ENGINE_SUPPORTED_COUNT

The number of engines that support the operation graph.

- ▶ `CUDNN_TYPE_INT64`; one element.
- ▶ Read-only attribute; placeholder only: currently not supported.

Finalization

CUDNN_STATUS_BAD_PARAM

An invalid attribute value was encountered. For example:

- ▶ One of the backend descriptors in `CUDNN_ATTR_OPERATIONGRAPH_OPS` is not finalized.
- ▶ The value `CUDNN_ATTR_OPERATIONGRAPH_HANDLE` is not a valid cuDNN handle.

CUDNN_STATUS_NOT_SUPPORTED

An unsupported attribute value was encountered. For example:

- ▶ The combination of operations of attribute `CUDNN_ATTR_OPERATIONGRAPH_OPS` is not supported.

CUDNN_STATUS_SUCCESS

The descriptor was finalized successfully.

9.2.16. CUDNN_BACKEND_TENSOR_DESCRIPTOR

Created with `cudaBackendCreate(CUDNN_BACKEND_TENSOR_DESCRIPTOR, &desc)`; the cuDNN backend tensor allows users to specify the memory storage of a generic tensor. A tensor is identified by a unique identifier and described by its data type, its data byte-alignment requirements, and the extents and strides of its dimensions. Optionally, a tensor element can be vector in one of its dimensions. A tensor can also be set to be virtual when it is an intermediate variable in a computation graph and not mapped to physical global memory storage.

Attributes

Attributes of a cuDNN backend tensor descriptors are values of enumeration type `cudaBackendAttributeName_t` with prefix `CUDNN_ATTR_TENSOR_`:

CUDNN_ATTR_TENSOR_UNIQUE_ID

An integer that uniquely identifies the tensor.

- ▶ `CUDNN_TYPE_INT64`; one element.
- ▶ Required attribute.

CUDNN_ATTR_TENSOR_DATA_TYPE

Data type of tensor.

- ▶ `CUDNN_TYPE_DATA_TYPE`; one element.
- ▶ Required attribute.

CUDNN_ATTR_TENSOR_BYTE_ALIGNMENT

Byte alignment of pointers for this tensor.

- ▶ CUDNN_TYPE_INT64; one element.
- ▶ Required attribute.

CUDNN_ATTR_TENSOR_DIMENSIONS

Tensor dimensions.

- ▶ CUDNN_TYPE_INT64; at most CUDNN_MAX_DIMS elements.
- ▶ Required attribute.

CUDNN_ATTR_TENSOR_STRIDES

Tensor strides.

- ▶ CUDNN_TYPE_INT64; at most CUDNN_MAX_DIMS elements.
- ▶ Required attribute.

CUDNN_ATTR_TENSOR_VECTOR_COUNT

Size of vectorization.

- ▶ CUDNN_TYPE_INT64; one element.
- ▶ Default value: 1

CUDNN_ATTR_TENSOR_VECTORIZED_DIMENSION

Index of the vectorized dimension.

- ▶ CUDNN_TYPE_INT64; one element.
- ▶ Required to be set before finalization if CUDNN_ATTR_TENSOR_VECTOR_COUNT is set to a value different than its default; otherwise it's ignored.

CUDNN_ATTR_TENSOR_IS_VIRTUAL

Indicates whether the tensor is virtual. A virtual tensor is an intermediate tensor in the operation graph that exists in transient and not read from or written to in global device memory.

- ▶ CUDNN_TYPE_BOOL; one element.
- ▶ Default value: `false`

Finalization

[`cudaBackendFinalize\(\)`](#) with a CUDNN_BACKEND_CONVOLUTION_DESCRIPTOR can have the following return values:

CUDNN_STATUS_BAD_PARAM

An invalid attribute value was encountered. For example:

- ▶ Any of the tensor dimensions or strides is not positive.
- ▶ The value of tensor alignment attribute is not divisible by the size of the data type.

CUDNN_STATUS_NOT_SUPPORTED

An unsupported attribute value was encountered. For example:

- ▶ The data type attribute is CUDNN_DATA_INT8x4, CUDNN_DATA_UINT8x4, or CUDNN_DATA_INT8x32.
- ▶ The data type attribute is CUDNN_DATA_INT8 and CUDNN_ATTR_TENSOR_VECTOR_COUNT value is not 1, 4, or 32.

CUDNN_STATUS_SUCCESS

The descriptor was finalized successfully.

9.2.17. CUDNN_BACKEND_VARIANT_PACK_DESCRIPTOR

Created with `cudaBackendCreate(CUDNN_BACKEND_VARIANT_PACK_DESCRIPTOR, &desc)`; the cuDNN backend variant pack plan allows users to set up pointers to device buffers to various non-virtual tensors, identified by unique identifiers, of the operation graph, workspace, and computation intermediates.

Attributes**CUDNN_ATTR_VARIANT_PACK_UNIQUE_IDS**

A unique identifier of tensor for each data pointer.

- ▶ CUDNN_TYPE_INT64; zero or more elements.
- ▶ Required attribute.

CUDNN_ATTR_VARIANT_PACK_DATA_POINTERS

Tensor data device pointers.

- ▶ CUDNN_TYPE_VOID_PTR; zero or more elements.
- ▶ Required attribute.

CUDNN_ATTR_VARIANT_PACK_INTERMEDIATES

Intermediate device pointers.

- ▶ CUDNN_TYPE_VOID_PTR; zero or more elements.
- ▶ Setting attribute unsupported. Placeholder for support to be added in a future version.

CUDNN_ATTR_VARIANT_PACK_WORKSPACE

Workspace to device pointer.

- ▶ CUDNN_TYPE_VOID_PTR; one element.
- ▶ Required attribute.

Finalization

The return values for `cudaBackendFinalize()` when called with a cuDNN backend variant pack descriptor is:

CUDNN_STATUS_SUCCESS

The descriptor was finalized successfully.

9.3. Use Cases

This section describes some typical use cases of the cuDNN backend convolution API; for example, setting up a simple operation graph, setting up an engine config for that operation graph, and finally setting up an execution plan and executing it with data pointers set in a variant pack descriptor.

9.3.1. Setting Up An Operation Graph For A Grouped Convolution

This use case creates an operation graph with a single grouped 3D convolution forward operation. It starts by setting up the input and output tensors, binding them to a convolution forward operation, and finally setting up an operation graph with a single node.

Procedure

1. Create tensor descriptors.

```

cudaBackendDescriptor x_desc;
cudaBackendCreateDescriptor(CUDNN_BACKEND_TENSOR_DESCRIPTOR, &x_desc);

cudaDataType_t dtype = CUDNN_DATA_FLOAT;
cudaBackendSetAttribute(desc, CUDNN_ATTR_TENSOR_DATA_TYPE,
                        CUDNN_TYPE_DATA_TYPE, 1, &dtype);

int64_t dimA[6] = {n, g, c, d, h, w};
int64_t strA[6] = {g * c * d * h * w, c * d * h * w, d * h * w, h * w, W, 1};
int64_t uid = 'x';
int64_t alignment = 4;

cudaBackendSetAttribute(desc, CUDNN_ATTR_TENSOR_DIMENSIONS,
                        CUDNN_TYPE_INT64, 6, dimA);

cudaBackendSetAttribute(desc, CUDNN_ATTR_TENSOR_STRIDES,
                        CUDNN_TYPE_INT64, 6, strA);

cudaBackendSetAttribute(desc, CUDNN_ATTR_TENSOR_UNIQUE_ID,
                        CUDNN_TYPE_INT64, 1, &uid);

cudaBackendSetAttribute(desc, CUDNN_ATTR_TENSOR_BYTE_ALIGNMENT,
                        CUDNN_TYPE_INT64, 1, &alignment);

cudaBackendFinalize(desc);

```

2. Repeat the above step for the convolution filter and response tensor descriptor. The six filter tensor dimensions are [g, k, c, t, r, s] and the six response tensor dimensions are [n, g, k, o, p, q], respectively. Below, when finalizing a convolution

operator to which the tensors are bound, dimension consistency is checked, meaning all n, g, c, k values shared among the three tensors are required to be the same. Otherwise, `CUDNN_STATUS_BAD_PARAM` status is returned.

For backward compatibility with how tensors are specified in `cudaTensorDescriptor_t` and used in convolution API, it is also possible to specify a 5D tensor with the following dimension:

- ▶ image: $[n, g*c, d, h, w]$
- ▶ filter: $[g*k, c, t, r, s]$
- ▶ response: $[n, g*k, o, p, q]$

In this format, a similar consistency check is performed when finalizing a convolution operator descriptor to which the tensors are bound.

3. Create, set, and finalize a convolution operator descriptor.

```
int64_t nbDims = 3;
cudaDataType_t compType = CUDNN_DATA_FLOAT;
cudaConvolutionMode_t mode = CUDNN_CONVOLUTION;
int64_t padA[] = [ 0, 0, 0 ];
int64_t filterStrA[] = [ 1, 1, 1 ];
int64_t dilationA[] = [ 1, 1, 1 ];

cudaBackendCreate(CUDNN_BACKEND_CONVOLUTION_DESCRIPTOR, &cDesc);

cudaBackendSetAttribute(cDesc, CUDNN_ATTR_CONVOLUTION_SPATIAL_DIMS,
    CUDNN_TYPE_INT64, 1, &nbDims);

cudaBackendSetAttribute(cDesc, CUDNN_ATTR_CONVOLUTION_COMP_TYPE,
    CUDNN_TYPE_DATA_TYPE, 1, &compType);

cudaBackendSetAttribute(cDesc, CUDNN_ATTR_CONVOLUTION_CONV_MODE,
    CUDNN_TYPE_CONVOLUTION_MODE, 1, &mode);

cudaBackendSetAttribute(cDesc, CUDNN_ATTR_CONVOLUTION_PRE_PADDINGS,
    CUDNN_TYPE_INT64, convDim, padA);

cudaBackendSetAttribute(cDesc, CUDNN_ATTR_CONVOLUTION_POST_PADDINGS,
    CUDNN_TYPE_INT64, convDim, padA);

cudaBackendSetAttribute(cDesc, CUDNN_ATTR_CONVOLUTION_DILATIONS,
    CUDNN_TYPE_INT64, convDim, dilationA);

cudaBackendSetAttribute(cDesc, CUDNN_ATTR_CONVOLUTION_FILTER_STRIDES,
    CUDNN_TYPE_INT64, convDim, filterStrA);
cudaBackendFinalize(cDesc);
```

4. Create, set, and finalize a convolution forward operation descriptor.

```
cudaBackendDescriptor_t fprop;
float alpha = 1.0;
float beta = 0.5;

cudaBackendCreate(CUDNN_BACKEND_OPERATION_CONVOLUTION_FORWARD_DESCRIPTOR,
    &fprop);
cudaBackendSetAttribute(fprop, CUDNN_ATTR_OPERATION_CONVOLUTION_FORWARD_X,
    CUDNN_TYPE_BACKEND_DESCRIPTOR, 1, &xDesc);
cudaBackendSetAttribute(fprop, CUDNN_ATTR_OPERATION_CONVOLUTION_FORWARD_W,
    CUDNN_TYPE_BACKEND_DESCRIPTOR, 1, &wDesc);
cudaBackendSetAttribute(fprop, CUDNN_ATTR_OPERATION_CONVOLUTION_FORWARD_Y,
    CUDNN_TYPE_BACKEND_DESCRIPTOR, 1, &yDesc);
cudaBackendSetAttribute(fprop,
    CUDNN_ATTR_OPERATION_CONVOLUTION_FORWARD_CONV_DESC,
    CUDNN_TYPE_BACKEND_DESCRIPTOR, 1, &cDesc);
```

```

cudaDnnBackendSetAttribute(fprop, CUDNN_ATTR_OPERATION_CONVOLUTION_FORWARD_ALPHA,
                             dtype, 1, alpha);
cudaDnnBackendSetAttribute(fprop, CUDNN_ATTR_OPERATION_CONVOLUTION_FORWARD_BETA,
                             dtype, 1, beta);

cudaDnnBackendFinalize(fprop);

```

5. Create, set, and finalize an operation graph descriptor.

```

cudaDnnBackendDescriptor_t op_graph;
cudaDnnBackendCreate(CUDNN_BACKEND_OPERATIONGRAPH_DESCRIPTOR, op_graph);
cudaDnnBackendSetAttribute(op_graph, CUDNN_ATTR_OPERATIONGRAPH_OPS,
                             CUDNN_TYPE_BACKEND_DESCRIPTOR, len, ops);
cudaDnnBackendSetAttribute(op_graph, CUDNN_ATTR_OPERATIONGRAPH_HANDLE,
                             CUDNN_TYPE_HANDLE, 1, &handle);
cudaDnnBackendFinalize(op_graph);

```

9.3.2. Setting Up An Engine Configuration

This use case describes the steps with which users can set up an engine config from a previously finalized operation graph. This is an example in which users would like to use the engine with `CUDNN_ATTR_ENGINE_GLOBAL_INDEX 0` for this operation graph and does not set any performance knobs.

Procedure

1. Create, set, and finalize an engine descriptor.

```

cudaDnnBackendDescriptor_t engine;
cudaDnnBackendCreateDescriptor(CUDNN_BACKEND_ENGINE_DESCRIPTOR, &engine);
cudaDnnBackendSetAttribute(engine, CUDNN_ATTR_ENGINE_OPERATION_GRAPH,
                             CUDNN_TYPE_BACKEND_DESCRIPTOR, 1, &opset);
int64_t gidx = 0;
cudaDnnBackendSetAttribute(engine, CUDNN_ATTR_ENGINE_GLOBAL_INDEX,
                             CUDNN_TYPE_INT64, 1, &gidx);
cudaDnnBackendFinalize(engine);

```

The user can query a finalized engine descriptor with `cudaDnnGetBackendAttribute()` API call for its attributes, including the performance knobs that it has. For simplicity, this use case skips this step and assumes the user is setting up an engine config descriptor below without making any changes to performance knobs.

2. Create, set, and finalize an engine config descriptor.

```

cudaDnnBackendDescriptor_t engcfg;
cudaDnnBackendSetAttribute(engcfg, CUDNN_ATTR_ENGINECFG_ENGINE,
                             CUDNN_TYPE_BACKEND_DESCRIPTOR, 1, &engine);
cudaDnnBackendFinalize(engcfg);

```

9.3.3. Setting Up And Executing A Plan

This use case describes the steps with which users set up an execution plan with a previously finalized engine config descriptor, set up the data pointer variant pack, and finally executing the plan.

Procedure

1. Create, set, and finalize an execution plan descriptor. Obtain workspace size to allocate.

```

cudaDnnBackendDescriptor_t plan;
cudaDnnBackendCreate(CUDNN_BACKEND_EXECUTION_PLAN_DESCRIPTOR, &plan);

```

```

cudaBackendSetAttribute(plan, CUDNN_ATTR_EXECUTION_PLAN_ENGINE_CONFIG,
                        CUDNN_TYPE_BACKEND_DESCRIPTOR, 1, &engcfg);
cudaBackendFinalize(plan);

int64_t workspaceSize;
cudaBackendGetAttribute(plan, CUDNN_ATTR_EXECUTION_PLAN_WORKSPACE_SIZE,
                        CUDNN_TYPE_INT64, 1, NULL, &workspaceSize)

```

2. Create, set and finalize a variant pack descriptor.

```

void *dev_ptrs[3] = {xData, wData, yData}; // device pointer
int64_t uids[3] = {'x', 'w', 'y'};
void *workspace;

cudaBackendDescriptor_t varpack;
cudaBackendCreate(CUDNN_BACKEND_VARIANT_PACK_DESCRIPTOR, &varpack);
cudaBackendSetAttribute(varpack, CUDNN_ATTR_VARIANT_PACK_DATA_POINTERS,
                        CUDNN_TYPE_VOID_PTR, 3, dev_ptrs);
cudaBackendSetAttribute(varpack, CUDNN_ATTR_VARIANT_PACK_UNIQUE_IDS,
                        CUDNN_TYPE_INT64, 3, uids);
cudaBackendSetAttribute(varpack, CUDNN_ATTR_VARIANT_PACK_WORKSPACE,
                        CUDNN_TYPE_VOID_PTR, 1, &workspace);
cudaBackendFinalize(varPack);

```

3. Execute the plan with a variant pack.

```

cudaBackendExecute(handle, plan, varpack);

```

Notice

This document is provided for information purposes only and shall not be regarded as a warranty of a certain functionality, condition, or quality of a product. NVIDIA Corporation ("NVIDIA") makes no representations or warranties, expressed or implied, as to the accuracy or completeness of the information contained in this document and assumes no responsibility for any errors contained herein. NVIDIA shall have no liability for the consequences or use of such information or for any infringement of patents or other rights of third parties that may result from its use. This document is not a commitment to develop, release, or deliver any Material (defined below), code, or functionality.

NVIDIA reserves the right to make corrections, modifications, enhancements, improvements, and any other changes to this document, at any time without notice.

Customer should obtain the latest relevant information before placing orders and should verify that such information is current and complete.

NVIDIA products are sold subject to the NVIDIA standard terms and conditions of sale supplied at the time of order acknowledgement, unless otherwise agreed in an individual sales agreement signed by authorized representatives of NVIDIA and customer ("Terms of Sale"). NVIDIA hereby expressly objects to applying any customer general terms and conditions with regards to the purchase of the NVIDIA product referenced in this document. No contractual obligations are formed either directly or indirectly by this document.

NVIDIA products are not designed, authorized, or warranted to be suitable for use in medical, military, aircraft, space, or life support equipment, nor in applications where failure or malfunction of the NVIDIA product can reasonably be expected to result in personal injury, death, or property or environmental damage. NVIDIA accepts no liability for inclusion and/or use of NVIDIA products in such equipment or applications and therefore such inclusion and/or use is at customer's own risk.

NVIDIA makes no representation or warranty that products based on this document will be suitable for any specified use. Testing of all parameters of each product is not necessarily performed by NVIDIA. It is customer's sole responsibility to evaluate and determine the applicability of any information contained in this document, ensure the product is suitable and fit for the application planned by customer, and perform the necessary testing for the application in order to avoid a default of the application or the product. Weaknesses in customer's product designs may affect the quality and reliability of the NVIDIA product and may result in additional or different conditions and/or requirements beyond those contained in this document. NVIDIA accepts no liability related to any default, damage, costs, or problem which may be based on or attributable to: (i) the use of the NVIDIA product in any manner that is contrary to this document or (ii) customer product designs.

No license, either expressed or implied, is granted under any NVIDIA patent right, copyright, or other NVIDIA intellectual property right under this document. Information published by NVIDIA regarding third-party products or services does not constitute a license from NVIDIA to use such products or services or a warranty or endorsement thereof. Use of such information may require a license from a third party under the patents or other intellectual property rights of the third party, or a license from NVIDIA under the patents or other intellectual property rights of NVIDIA.

Reproduction of information in this document is permissible only if approved in advance by NVIDIA in writing, reproduced without alteration and in full compliance with all applicable export laws and regulations, and accompanied by all associated conditions, limitations, and notices.

THIS DOCUMENT AND ALL NVIDIA DESIGN SPECIFICATIONS, REFERENCE BOARDS, FILES, DRAWINGS, DIAGNOSTICS, LISTS, AND OTHER DOCUMENTS (TOGETHER AND SEPARATELY, "MATERIALS") ARE BEING PROVIDED "AS IS." NVIDIA MAKES NO WARRANTIES, EXPRESSED, IMPLIED, STATUTORY, OR OTHERWISE WITH RESPECT TO THE MATERIALS, AND EXPRESSLY DISCLAIMS ALL IMPLIED WARRANTIES OF NON-INFRINGEMENT, MERCHANTABILITY, AND FITNESS FOR A PARTICULAR PURPOSE. TO THE EXTENT NOT PROHIBITED BY LAW, IN NO EVENT WILL NVIDIA BE LIABLE FOR ANY DAMAGES, INCLUDING WITHOUT LIMITATION ANY DIRECT, INDIRECT, SPECIAL, INCIDENTAL, PUNITIVE, OR CONSEQUENTIAL DAMAGES, HOWEVER CAUSED AND REGARDLESS OF THE THEORY OF LIABILITY, ARISING OUT OF ANY USE OF THIS DOCUMENT, EVEN IF NVIDIA HAS BEEN ADVISED OF THE POSSIBILITY OF SUCH DAMAGES. Notwithstanding any damages that customer might incur for any reason whatsoever, NVIDIA's aggregate and cumulative liability towards customer for the products described herein shall be limited in accordance with the Terms of Sale for the product.

VESA DisplayPort

DisplayPort and DisplayPort Compliance Logo, DisplayPort Compliance Logo for Dual-mode Sources, and DisplayPort Compliance Logo for Active Cables are trademarks owned by the Video Electronics Standards Association in the United States and other countries.

HDMI

HDMI, the HDMI logo, and High-Definition Multimedia Interface are trademarks or registered trademarks of HDMI Licensing LLC.

ARM

ARM, AMBA and ARM Powered are registered trademarks of ARM Limited. Cortex, MPCore and Mali are trademarks of ARM Limited. All other brands or product names are the property of their respective holders. "ARM" is used to represent ARM Holdings plc; its operating company ARM Limited; and the regional subsidiaries ARM Inc.; ARM KK; ARM Korea Limited.; ARM Taiwan Limited; ARM France SAS; ARM Consulting (Shanghai) Co. Ltd.; ARM Germany GmbH; ARM Embedded Technologies Pvt. Ltd.; ARM Norway, AS and ARM Sweden AB.

OpenCL

OpenCL is a trademark of Apple Inc. used under license to the Khronos Group Inc.

Trademarks

NVIDIA, the NVIDIA logo, and cuBLAS, CUDA, CUDA Toolkit, cuDNN, DALI, DIGITS, DGX, DGX-1, DGX-2, DGX Station, DLProf, GPU, JetPack, Jetson, Kepler, Maxwell, NCCL, Nsight Compute, Nsight Systems, NVCAffe, NVIDIA Ampere GPU architecture, NVIDIA Deep Learning SDK, NVIDIA Developer Program, NVIDIA GPU Cloud, NVLink, NVSHMEM, PerfWorks, Pascal, SDK Manager, T4, Tegra, TensorRT, TensorRT Inference Server, Tesla, TF-TRT, Triton Inference Server, Turing, and Volta are trademarks and/or registered trademarks of NVIDIA Corporation in the United States and other countries. Other company and product names may be trademarks of the respective companies with which they are associated.

Copyright

© 2017-2021 NVIDIA Corporation. All rights reserved.

