



# CUDNN 7.6.2

DU-06702-001\_v07 | July 2019

## Developer Guide



# TABLE OF CONTENTS

<b>Chapter 1. Overview</b> .....	<b>1</b>
<b>Chapter 2. General Description</b> .....	<b>2</b>
2.1. Programming Model.....	2
2.2. Convolution Formulas.....	3
2.3. Notation.....	4
2.4. Tensor Descriptor.....	5
2.4.1. WXYZ Tensor Descriptor.....	6
2.4.2. 4-D Tensor Descriptor.....	6
2.4.3. 5-D Tensor Description.....	6
2.4.4. Fully-packed tensors.....	6
2.4.5. Partially-packed tensors.....	6
2.4.6. Spatially packed tensors.....	7
2.4.7. Overlapping tensors.....	7
2.5. Data Layout Formats.....	7
2.5.1. Example.....	7
2.5.2. NCHW Memory Layout.....	8
2.5.3. NHWC Memory Layout.....	9
2.5.4. NC/32HW32 Memory Layout.....	10
2.6. Thread Safety.....	12
2.7. Reproducibility (determinism).....	12
2.8. Scaling Parameters.....	12
2.9. Tensor Core Operations.....	14
2.9.1. Basics.....	14
2.9.2. Convolution Functions.....	15
2.9.2.1. Prerequisite.....	15
2.9.2.2. Supported Algorithms.....	15
2.9.2.3. Data and Filter Formats.....	15
2.9.3. RNN Functions.....	16
2.9.3.1. Prerequisite.....	16
2.9.3.2. Supported Algorithms.....	16
2.9.3.3. Data and Filter Formats.....	16
2.9.4. Tensor Transformations.....	17
2.9.4.1. FP16 Data.....	17
2.9.4.2. FP32-to-FP16 Conversion.....	17
2.9.4.3. Padding.....	18
2.9.4.4. Folding.....	19
2.9.4.5. Conversion Between NCHW and NHWC.....	19
2.9.5. Guidelines for a Deep Learning Compiler.....	19
2.10. GPU and driver requirements.....	19
2.11. Backward compatibility and deprecation policy.....	20

2.12. Grouped Convolutions.....	20
2.13. API Logging.....	22
2.14. Features of RNN Functions.....	23
2.15. Mixed Precision Numerical Accuracy.....	26
<b>Chapter 3. cuDNN Datatypes Reference.....</b>	<b>27</b>
3.1. cudnnActivationDescriptor_t.....	27
3.2. cudnnActivationMode_t.....	27
3.3. cudnnAttnDescriptor_t.....	28
3.4. cudnnAttnQueryMap_t.....	28
3.5. cudnnBatchNormMode_t.....	28
3.6. cudnnBatchNormOps_t.....	29
3.7. cudnnConvolutionBwdDataAlgo_t.....	29
3.8. cudnnConvolutionBwdDataAlgoPerf_t.....	30
3.9. cudnnConvolutionBwdDataPreference_t.....	31
3.10. cudnnConvolutionBwdFilterAlgo_t.....	32
3.11. cudnnConvolutionBwdFilterAlgoPerf_t.....	32
3.12. cudnnConvolutionBwdFilterPreference_t.....	33
3.13. cudnnConvolutionDescriptor_t.....	34
3.14. cudnnConvolutionFwdAlgo_t.....	34
3.15. cudnnConvolutionFwdAlgoPerf_t.....	35
3.16. cudnnConvolutionFwdPreference_t.....	35
3.17. cudnnConvolutionMode_t.....	36
3.18. cudnnCTCLossAlgo_t.....	36
3.19. cudnnCTCLossDescriptor_t.....	37
3.20. cudnnDataType_t.....	37
3.21. cudnnDeterminism_t.....	38
3.22. cudnnDirectionMode_t.....	38
3.23. cudnnDivNormMode_t.....	38
3.24. cudnnDropoutDescriptor_t.....	39
3.25. cudnnErrQueryMode_t.....	39
3.26. cudnnFilterDescriptor_t.....	39
3.27. cudnnFoldingDirection_t.....	39
3.28. cudnnFusedOps_t.....	40
3.29. cudnnFusedOpsConstParamLabel_t.....	41
3.30. cudnnFusedOpsConstParamPack_t.....	56
3.31. cudnnFusedOpsPlan_t.....	57
3.32. cudnnFusedOpsPointerPlaceholder_t.....	57
3.33. cudnnFusedOpsVariantParamLabel_t.....	57
3.34. cudnnFusedOpsVariantParamPack_t.....	66
3.35. cudnnHandle_t.....	66
3.36. cudnnIndicesType_t.....	66
3.37. cudnnLossNormalizationMode_t.....	66
3.38. cudnnLRNMode_t.....	67

3.39. cudnnMathType_t.....	67
3.40. cudnnMultiHeadAttnWeightKind_t.....	67
3.41. cudnnNanPropagation_t.....	68
3.42. cudnnOpTensorDescriptor_t.....	68
3.43. cudnnOpTensorOp_t.....	68
3.44. cudnnPersistentRNNPlan_t.....	69
3.45. cudnnPoolingDescriptor_t.....	69
3.46. cudnnPoolingMode_t.....	69
3.47. cudnnReduceTensorDescriptor_t.....	70
3.48. cudnnReduceTensorIndices_t.....	70
3.49. cudnnReduceTensorOp_t.....	70
3.50. cudnnReorderType_t.....	71
3.51. cudnnRNNAlgo_t.....	71
3.52. cudnnRNNBiasMode_t.....	72
3.53. cudnnRNNClipMode_t.....	72
3.54. cudnnRNNDataDescriptor_t.....	73
3.55. cudnnRNNDataLayout_t.....	73
3.56. cudnnRNNDescriptor_t.....	73
3.57. cudnnRNNInputMode_t.....	73
3.58. cudnnRNNMode_t.....	74
3.59. cudnnRNNPaddingMode_t.....	76
3.60. cudnnSamplerType_t.....	76
3.61. cudnnSeqDataAxis_t.....	76
3.62. cudnnSeqDataDescriptor_t.....	77
3.63. cudnnSoftmaxAlgorithm_t.....	77
3.64. cudnnSoftmaxMode_t.....	78
3.65. cudnnSpatialTransformerDescriptor_t.....	78
3.66. cudnnStatus_t.....	78
3.67. cudnnTensorDescriptor_t.....	80
3.68. cudnnTensorFormat_t.....	80
3.69. cudnnTensorTransformDescriptor_t.....	81
3.70. cudnnWgradMode_t.....	81
<b>Chapter 4. cuDNN API Reference.....</b>	<b>82</b>
4.1. cudnnActivationBackward.....	82
4.2. cudnnActivationForward.....	84
4.3. cudnnAddTensor.....	85
4.4. cudnnBatchNormalizationBackward.....	86
4.5. cudnnBatchNormalizationBackwardEx.....	89
4.6. cudnnBatchNormalizationForwardInference.....	92
4.7. cudnnBatchNormalizationForwardTraining.....	94
4.8. cudnnBatchNormalizationForwardTrainingEx.....	97
4.9. cudnnConvolutionBackwardBias.....	101
4.10. cudnnConvolutionBackwardData.....	102

4.11. cudnnConvolutionBackwardFilter.....	108
4.12. cudnnConvolutionBiasActivationForward.....	114
4.13. cudnnConvolutionForward.....	117
4.14. cudnnCreate.....	124
4.15. cudnnCreateActivationDescriptor.....	125
4.16. cudnnCreateAlgorithmDescriptor.....	126
4.17. cudnnCreateAlgorithmPerformance.....	126
4.18. cudnnCreateAttnDescriptor.....	126
4.19. cudnnCreateConvolutionDescriptor.....	127
4.20. cudnnCreateCTCLossDescriptor.....	127
4.21. cudnnCreateDropoutDescriptor.....	128
4.22. cudnnCreateFilterDescriptor.....	128
4.23. cudnnCreateFusedOpsConstParamPack.....	128
4.24. cudnnCreateFusedOpsPlan.....	129
4.25. cudnnCreateFusedOpsVariantParamPack.....	129
4.26. cudnnCreateLRNDescriptor.....	130
4.27. cudnnCreateOpTensorDescriptor.....	130
4.28. cudnnCreatePersistentRNNPlan.....	131
4.29. cudnnCreatePoolingDescriptor.....	131
4.30. cudnnCreateReduceTensorDescriptor.....	132
4.31. cudnnCreateRNNDataDescriptor.....	132
4.32. cudnnCreateRNNDescriptor.....	132
4.33. cudnnCreateSeqDataDescriptor.....	133
4.34. cudnnCreateSpatialTransformerDescriptor.....	133
4.35. cudnnCreateTensorDescriptor.....	133
4.36. cudnnCreateTensorTransformDescriptor.....	134
4.37. cudnnCTCLoss.....	134
4.38. cudnnDeriveBNTensorDescriptor.....	136
4.39. cudnnDestroy.....	137
4.40. cudnnDestroyActivationDescriptor.....	138
4.41. cudnnDestroyAlgorithmDescriptor.....	138
4.42. cudnnDestroyAlgorithmPerformance.....	138
4.43. cudnnDestroyAttnDescriptor.....	138
4.44. cudnnDestroyConvolutionDescriptor.....	139
4.45. cudnnDestroyCTCLossDescriptor.....	139
4.46. cudnnDestroyDropoutDescriptor.....	139
4.47. cudnnDestroyFilterDescriptor.....	140
4.48. cudnnDestroyFusedOpsConstParamPack.....	140
4.49. cudnnDestroyFusedOpsPlan.....	140
4.50. cudnnDestroyFusedOpsVariantParamPack.....	141
4.51. cudnnDestroyLRNDescriptor.....	141
4.52. cudnnDestroyOpTensorDescriptor.....	141
4.53. cudnnDestroyPersistentRNNPlan.....	142

4.54. cudnnDestroyPoolingDescriptor.....	142
4.55. cudnnDestroyReduceTensorDescriptor.....	142
4.56. cudnnDestroyRNNDataDescriptor.....	142
4.57. cudnnDestroyRNNDescriptor.....	143
4.58. cudnnDestroySeqDataDescriptor.....	143
4.59. cudnnDestroySpatialTransformerDescriptor.....	143
4.60. cudnnDestroyTensorDescriptor.....	143
4.61. cudnnDestroyTensorTransformDescriptor.....	144
4.62. cudnnDivisiveNormalizationBackward.....	144
4.63. cudnnDivisiveNormalizationForward.....	146
4.64. cudnnDropoutBackward.....	148
4.65. cudnnDropoutForward.....	149
4.66. cudnnDropoutGetReserveSpaceSize.....	151
4.67. cudnnDropoutGetStatesSize.....	151
4.68. cudnnFindConvolutionBackwardDataAlgorithm.....	152
4.69. cudnnFindConvolutionBackwardDataAlgorithmEx.....	153
4.70. cudnnFindConvolutionBackwardFilterAlgorithm.....	155
4.71. cudnnFindConvolutionBackwardFilterAlgorithmEx.....	157
4.72. cudnnFindConvolutionForwardAlgorithm.....	159
4.73. cudnnFindConvolutionForwardAlgorithmEx.....	161
4.74. cudnnFindRNNBackwardDataAlgorithmEx.....	163
4.75. cudnnFindRNNBackwardWeightsAlgorithmEx.....	169
4.76. cudnnFindRNNForwardInferenceAlgorithmEx.....	172
4.77. cudnnFindRNNForwardTrainingAlgorithmEx.....	177
4.78. cudnnFusedOpsExecute.....	181
4.79. cudnnGetActivationDescriptor.....	182
4.80. cudnnGetAlgorithmDescriptor.....	182
4.81. cudnnGetAlgorithmPerformance.....	183
4.82. cudnnGetAlgorithmSpaceSize.....	183
4.83. cudnnGetAttnDescriptor.....	184
4.84. cudnnBatchNormalizationBackwardExWorkspaceSize.....	185
4.85. cudnnBatchNormalizationForwardTrainingExWorkspaceSize.....	187
4.86. cudnnGetBatchNormalizationTrainingExReserveSpaceSize.....	188
4.87. cudnnGetCallback.....	189
4.88. cudnnGetConvolution2dDescriptor.....	190
4.89. cudnnGetConvolution2dForwardOutputDim.....	191
4.90. cudnnGetConvolutionBackwardDataAlgorithm.....	192
4.91. cudnnGetConvolutionBackwardDataAlgorithm_v7.....	193
4.92. cudnnGetConvolutionBackwardDataAlgorithmMaxCount.....	194
4.93. cudnnGetConvolutionBackwardDataWorkspaceSize.....	195
4.94. cudnnGetConvolutionBackwardFilterAlgorithm.....	196
4.95. cudnnGetConvolutionBackwardFilterAlgorithm_v7.....	197
4.96. cudnnGetConvolutionBackwardFilterAlgorithmMaxCount.....	198

4.97. cudnnGetConvolutionBackwardFilterWorkspaceSize.....	199
4.98. cudnnGetConvolutionForwardAlgorithm.....	200
4.99. cudnnGetConvolutionForwardAlgorithm_v7.....	201
4.100. cudnnGetConvolutionForwardAlgorithmMaxCount.....	202
4.101. cudnnGetConvolutionForwardWorkspaceSize.....	203
4.102. cudnnGetConvolutionGroupCount.....	204
4.103. cudnnGetConvolutionMathType.....	205
4.104. cudnnGetConvolutionNdDescriptor.....	205
4.105. cudnnGetConvolutionNdForwardOutputDim.....	206
4.106. cudnnGetConvolutionReorderType.....	207
4.107. cudnnGetCTCLossDescriptor.....	208
4.108. cudnnGetCTCLossWorkspaceSize.....	208
4.109. cudnnGetCudartVersion.....	209
4.110. cudnnGetDropoutDescriptor.....	210
4.111. cudnnGetErrorString.....	210
4.112. cudnnGetFilter4dDescriptor.....	211
4.113. cudnnGetFilterNdDescriptor.....	212
4.114. cudnnGetFusedOpsConstParamPackAttribute.....	212
4.115. cudnnGetFusedOpsVariantParamPackAttribute.....	213
4.116. cudnnGetLRNDescriptor.....	214
4.117. cudnnGetMultiHeadAttnBuffers.....	215
4.118. cudnnGetMultiHeadAttnWeights.....	215
4.119. cudnnGetOpTensorDescriptor.....	217
4.120. cudnnGetPooling2dDescriptor.....	217
4.121. cudnnGetPooling2dForwardOutputDim.....	218
4.122. cudnnGetPoolingNdDescriptor.....	219
4.123. cudnnGetPoolingNdForwardOutputDim.....	220
4.124. cudnnGetProperty.....	221
4.125. cudnnGetReduceTensorDescriptor.....	221
4.126. cudnnGetReductionIndicesSize.....	222
4.127. cudnnGetReductionWorkspaceSize.....	223
4.128. cudnnGetRNNBiasMode.....	223
4.129. cudnnGetRNNDataDescriptor.....	224
4.130. cudnnGetRNNDescriptor.....	225
4.131. cudnnGetRNNLinLayerBiasParams.....	226
4.132. cudnnGetRNNLinLayerMatrixParams.....	229
4.133. cudnnGetRNNPaddingMode.....	232
4.134. cudnnGetRNNParamsSize.....	232
4.135. cudnnGetRNNProjectionLayers.....	233
4.136. cudnnGetRNNTrainingReserveSize.....	234
4.137. cudnnGetRNNWorkspaceSize.....	235
4.138. cudnnGetSeqDataDescriptor.....	236
4.139. cudnnGetStream.....	237

4.140. cudnnGetTensor4dDescriptor.....	238
4.141. cudnnGetTensorNdDescriptor.....	239
4.142. cudnnGetTensorSizeInBytes.....	239
4.143. cudnnGetTensorTransformDescriptor.....	240
4.144. cudnnGetVersion.....	241
4.145. cudnnIm2Col.....	241
4.146. cudnnInitTransformDest.....	242
4.147. cudnnLRNCrossChannelBackward.....	243
4.148. cudnnLRNCrossChannelForward.....	244
4.149. cudnnMakeFusedOpsPlan.....	246
4.150. cudnnMultiHeadAttnBackwardData.....	246
4.151. cudnnMultiHeadAttnBackwardWeights.....	248
4.152. cudnnMultiHeadAttnForward.....	249
4.153. cudnnOpTensor.....	251
4.154. cudnnPoolingBackward.....	253
4.155. cudnnPoolingForward.....	255
4.156. cudnnQueryRuntimeError.....	256
4.157. cudnnReduceTensor.....	258
4.158. cudnnReorderFilterAndBias.....	259
4.159. cudnnRestoreAlgorithm.....	260
4.160. cudnnRestoreDropoutDescriptor.....	261
4.161. cudnnRNNBackwardData.....	262
4.162. cudnnRNNBackwardDataEx.....	267
4.163. cudnnRNNBackwardWeights.....	272
4.164. cudnnRNNBackwardWeightsEx.....	274
4.165. cudnnRNNForwardInference.....	277
4.166. cudnnRNNForwardInferenceEx.....	280
4.167. cudnnRNNForwardTraining.....	284
4.168. cudnnRNNForwardTrainingEx.....	288
4.169. cudnnRNNGetClip.....	292
4.170. cudnnRNNSetClip.....	293
4.171. cudnnSaveAlgorithm.....	294
4.172. cudnnScaleTensor.....	294
4.173. cudnnSetActivationDescriptor.....	295
4.174. cudnnSetAlgorithmDescriptor.....	296
4.175. cudnnSetAlgorithmPerformance.....	296
4.176. cudnnSetAttnDescriptor.....	297
4.177. cudnnSetCallback.....	299
4.178. cudnnSetConvolution2dDescriptor.....	300
4.179. cudnnSetConvolutionGroupCount.....	301
4.180. cudnnSetConvolutionMathType.....	302
4.181. cudnnSetConvolutionNdDescriptor.....	302
4.182. cudnnSetConvolutionReorderType.....	303



4.183. cudnnSetCTCLossDescriptor.....	304
4.184. cudnnSetCTCLossDescriptorEx.....	304
4.185. cudnnSetDropoutDescriptor.....	305
4.186. cudnnSetFilter4dDescriptor.....	306
4.187. cudnnSetFilterNdDescriptor.....	307
4.188. cudnnSetFusedOpsConstParamPackAttribute.....	309
4.189. cudnnSetFusedOpsVariantParamPackAttribute.....	310
4.190. cudnnSetLRNDescriptor.....	310
4.191. cudnnSetOpTensorDescriptor.....	311
4.192. cudnnSetPersistentRNNPlan.....	312
4.193. cudnnSetPooling2dDescriptor.....	312
4.194. cudnnSetPoolingNdDescriptor.....	313
4.195. cudnnSetReduceTensorDescriptor.....	314
4.196. cudnnSetRNNBiasMode.....	315
4.197. cudnnSetRNNDataDescriptor.....	316
4.198. cudnnSetRNNDescriptor.....	317
4.199. cudnnSetRNNDescriptor_v5.....	318
4.200. cudnnSetRNNDescriptor_v6.....	320
4.201. cudnnSetRNNMatrixMathType.....	321
4.202. cudnnSetRNNPaddingMode.....	322
4.203. cudnnSetRNNProjectionLayers.....	322
4.204. cudnnSetSeqDataDescriptor.....	324
4.205. cudnnSetSpatialTransformerNdDescriptor.....	325
4.206. cudnnSetStream.....	326
4.207. cudnnSetTensor4dDescriptor.....	327
4.208. cudnnSetTensor4dDescriptorEx.....	328
4.209. cudnnSetTensor.....	329
4.210. cudnnSetTensorNdDescriptor.....	330
4.211. cudnnSetTensorNdDescriptorEx.....	331
4.212. cudnnSetTensorTransformDescriptor.....	332
4.213. cudnnSoftmaxBackward.....	333
4.214. cudnnSoftmaxForward.....	335
4.215. cudnnSpatialTfGridGeneratorBackward.....	336
4.216. cudnnSpatialTfGridGeneratorForward.....	337
4.217. cudnnSpatialTfSamplerBackward.....	338
4.218. cudnnSpatialTfSamplerForward.....	340
4.219. cudnnTransformTensor.....	341
4.220. cudnnTransformTensorEx.....	342
<b>Chapter 5. Acknowledgments.....</b>	<b>344</b>
5.1. University of Tennessee.....	344
5.2. University of California, Berkeley.....	344
5.3. Facebook AI Research, New York.....	345



# Chapter 1.

## OVERVIEW

NVIDIA® cuDNN is a GPU-accelerated library of primitives for deep neural networks. It provides highly tuned implementations of routines arising frequently in DNN applications:

- ▶ Convolution forward and backward, including cross-correlation
- ▶ Pooling forward and backward
- ▶ Softmax forward and backward
- ▶ Neuron activations forward and backward:
  - ▶ Rectified linear (ReLU)
  - ▶ Sigmoid
  - ▶ Hyperbolic tangent (TANH)
- ▶ Tensor transformation functions
- ▶ LRN, LCN and batch normalization forward and backward

cuDNN's convolution routines aim for a performance that is competitive with the fastest GEMM (matrix multiply)-based implementations of such routines, while using significantly less memory.

cuDNN features include customizable data layouts, supporting flexible dimension ordering, striding, and subregions for the 4D tensors used as inputs and outputs to all of its routines. This flexibility allows easy integration into any neural network implementation, and avoids the input/output transposition steps sometimes necessary with GEMM-based convolutions.

cuDNN offers a context-based API that allows for easy multithreading and (optional) interoperability with CUDA streams.

# Chapter 2.

## GENERAL DESCRIPTION

Basic concepts are described in this section.

### 2.1. Programming Model

The cuDNN Library exposes a Host API but assumes that for operations using the GPU, the necessary data is directly accessible from the device.

An application using cuDNN must initialize a handle to the library context by calling `cudaDnnCreate()`. This handle is explicitly passed to every subsequent library function that operates on GPU data. Once the application finishes using cuDNN, it can release the resources associated with the library handle using `cudaDnnDestroy()`. This approach allows the user to explicitly control the library's functioning when using multiple host threads, GPUs and CUDA Streams.

For example, an application can use `cudaSetDevice()` to associate different devices with different host threads, and in each of those host threads, use a unique cuDNN handle that directs the library calls to the device associated with it. Thus the cuDNN library calls made with different handles will automatically run on different devices.

The device associated with a particular cuDNN context is assumed to remain unchanged between the corresponding `cudaDnnCreate()` and `cudaDnnDestroy()` calls. In order for the cuDNN library to use a different device within the same host thread, the application must set the new device to be used by calling `cudaSetDevice()` and then create another cuDNN context, which will be associated with the new device, by calling `cudaDnnCreate()`.

#### cuDNN API Compatibility

Beginning in cuDNN 7, the binary compatibility of patch and minor releases is maintained as follows:

- ▶ Any patch release x.y.z is forward- or backward-compatible with applications built against another cuDNN patch release x.y.w (i.e., of the same major and minor version number, but having w!=z)

- ▶ cuDNN minor releases beginning with cuDNN 7 are binary backward-compatible with applications built against the same or earlier patch release (i.e., an app built against cuDNN 7.x is binary compatible with cuDNN library 7.y, where  $y \geq x$ )
- ▶ Applications compiled with a cuDNN version 7.y are not guaranteed to work with 7.x release when  $y > x$ .

## 2.2. Convolution Formulas

This section describes the various convolution formulas implemented in cuDNN convolution functions.

The convolution terms described in the table below apply to all the convolution formulas that follow.

**TABLE OF CONVOLUTION TERMS**

Term	Description
$x$	Input (image) Tensor
$w$	Weight Tensor
$y$	Output Tensor
$n$	Current Batch Size
$c$	Current Input Channel
$C$	Total Input Channels
$H$	Input Image Height
$W$	Input Image Width
$k$	Current Output Channel
$K$	Total Output Channels
$p$	Current Output Height Position
$q$	Current Output Width Position
$G$	Group Count
$pad$	Padding Value
$u$	Vertical Subsample Stride (along Height)
$v$	Horizontal Subsample Stride (along Width)
$dil_h$	Vertical Dilation (along Height)
$dil_w$	Horizontal Dilation (along Width)
$r$	Current Filter Height
$R$	Total Filter Height
$s$	Current Filter Width
$S$	Total Filter Width

Term	Description
$C_g$	$\frac{C}{G}$
$K_g$	$\frac{K}{G}$

### Normal Convolution (using cross-correlation mode)

$$y_{n, k, p, q} = \sum_c^C \sum_r^R \sum_s^S x_{n, c, p+r, q+s} \times w_{k, c, r, s}$$

### Convolution with Padding

$$x_{<0, <0} = 0$$

$$x_{>H, >W} = 0$$

$$y_{n, k, p, q} = \sum_c^C \sum_r^R \sum_s^S x_{n, c, p+r-pad, q+s-pad} \times w_{k, c, r, s}$$

### Convolution with Subsample-Striding

$$y_{n, k, p, q} = \sum_c^C \sum_r^R \sum_s^S x_{n, c, (p*u) + r, (q*v) + s} \times w_{k, c, r, s}$$

### Convolution with Dilation

$$y_{n, k, p, q} = \sum_c^C \sum_r^R \sum_s^S x_{n, c, p + (r*dilh), q + (s*dilw)} \times w_{k, c, r, s}$$

### Convolution using Convolution Mode

$$y_{n, k, p, q} = \sum_c^C \sum_r^R \sum_s^S x_{n, c, p+r, q+s} \times w_{k, c, R-r-1, S-s-1}$$

### Convolution using Grouped Convolution

$$C_g = \frac{C}{G}$$

$$K_g = \frac{K}{G}$$

$$y_{n, k, p, q} = \sum_c^{C_g} \sum_r^R \sum_s^S x_{n, C_g * \text{floor}(k/K_g) + c, p+r, q+s} \times w_{k, c, r, s}$$

## 2.3. Notation

As of CUDNN v4 we have adopted a mathematically-inspired notation for layer inputs and outputs using  $\mathbf{x}$ ,  $\mathbf{y}$ ,  $d\mathbf{x}$ ,  $d\mathbf{y}$ ,  $\mathbf{b}$ ,  $\mathbf{w}$  for common layer parameters. This was done to improve the readability and ease of understanding of the meaning of the parameters. All layers now follow a uniform convention as below:

**During Inference:**

```
y = layerFunction(x, otherParams).
```

**During backpropagation:**

```
(dx, dOtherParams) = layerFunctionGradient(x, y, dy, otherParams)
```

For **convolution** the notation is

```
y = x*w+b
```

where  $\mathbf{w}$  is the matrix of filter weights,  $\mathbf{x}$  is the previous layer's data (during inference),  $\mathbf{y}$  is the next layer's data,  $\mathbf{b}$  is the bias and  $*$  is the convolution operator.

In backpropagation routines the parameters keep their meanings.

The parameters  $d\mathbf{x}$ ,  $d\mathbf{y}$ ,  $d\mathbf{w}$ ,  $d\mathbf{b}$  always refer to the gradient of the final network error function with respect to a given parameter. So  $d\mathbf{y}$  in all backpropagation routines always refers to error gradient backpropagated through the network computation graph so far. Similarly other parameters in more specialized layers, such as, for instance,  $d\mathbf{Means}$  or  $d\mathbf{BnBias}$  refer to gradients of the loss function wrt those parameters.



$\mathbf{w}$  is used in the API for both the width of the  $\mathbf{x}$  tensor and convolution filter matrix. To resolve this ambiguity we use  $\mathbf{w}$  and `filter` notation interchangeably for convolution filter weight matrix. The meaning is clear from the context since the layer width is always referenced near its height.

## 2.4. Tensor Descriptor

The cuDNN Library describes data holding images, videos and any other data with contents with a generic n-D tensor defined with the following parameters :

- ▶ a dimension `nbDims` from 3 to 8
- ▶ a data type (32-bit floating point, 64 bit-floating point, 16 bit floating point...)
- ▶ `dimA` integer array defining the size of each dimension
- ▶ `strideA` integer array defining the stride of each dimension (e.g the number of elements to add to reach the next element from the same dimension)

The first dimension of the tensor defines the batch size  $\mathbf{n}$ , and the second dimension defines the number of features maps  $\mathbf{c}$ . This tensor definition allows for example to have some dimensions overlapping each others within the same tensor by having the stride of one dimension smaller than the product of the dimension and the stride of the next dimension. In cuDNN, unless specified otherwise, all routines will support tensors with overlapping dimensions for forward pass input tensors, however, dimensions of the

output tensors cannot overlap. Even though this tensor format supports negative strides (which can be useful for data mirroring), cuDNN routines do not support tensors with negative strides unless specified otherwise.

### 2.4.1. WXYZ Tensor Descriptor

Tensor descriptor formats are identified using acronyms, with each letter referencing a corresponding dimension. In this document, the usage of this terminology implies :

- ▶ all the strides are strictly positive
- ▶ the dimensions referenced by the letters are sorted in decreasing order of their respective strides

### 2.4.2. 4-D Tensor Descriptor

A 4-D Tensor descriptor is used to define the format for batches of 2D images with 4 letters : N,C,H,W for respectively the batch size, the number of feature maps, the height and the width. The letters are sorted in decreasing order of the strides. The commonly used 4-D tensor formats are :

- ▶ NCHW
- ▶ NHWC
- ▶ CHWN

### 2.4.3. 5-D Tensor Description

A 5-D Tensor descriptor is used to define the format of batch of 3D images with 5 letters : N,C,D,H,W for respectively the batch size, the number of feature maps, the depth, the height and the width. The letters are sorted in decreasing order of the strides. The commonly used 5-D tensor formats are called :

- ▶ NCDHW
- ▶ NDHWC
- ▶ CDHWN

### 2.4.4. Fully-packed tensors

A tensor is defined as **XYZ-fully-packed** if and only if :

- ▶ the number of tensor dimensions is equal to the number of letters preceding the **fully-packed** suffix.
- ▶ the stride of the  $i$ -th dimension is equal to the product of the  $(i+1)$ -th dimension by the  $(i+1)$ -th stride.
- ▶ the stride of the last dimension is 1.

### 2.4.5. Partially-packed tensors



The partially 'XYZ-packed' terminology only applies in a context of a tensor format described with a superset of the letters used to define a partially-packed tensor. A WXYZ tensor is defined as **XYZ-packed** if and only if :

- ▶ the strides of all dimensions NOT referenced in the -packed suffix are greater or equal to the product of the next dimension by the next stride.
- ▶ the stride of each dimension referenced in the -packed suffix in position  $i$  is equal to the product of the  $(i+1)$ -st dimension by the  $(i+1)$ -st stride.
- ▶ if last tensor's dimension is present in the -packed suffix, its stride is 1.

For example a NHWC tensor WC-packed means that the  $c\_stride$  is equal to 1 and  $w\_stride$  is equal to  $c\_dim \times c\_stride$ . In practice, the -packed suffix is usually with slowest changing dimensions of a tensor but it is also possible to refer to a NCHW tensor that is only N-packed.

## 2.4.6. Spatially packed tensors

Spatially-packed tensors are defined as partially-packed in spatial dimensions.

For example a spatially-packed 4D tensor would mean that the tensor is either NCHW HW-packed or CNHW HW-packed.

## 2.4.7. Overlapping tensors

A tensor is defined to be overlapping if a iterating over a full range of dimensions produces the same address more than once.

In practice an overlapped tensor will have  $stride[i-1] < stride[i] \times dim[i]$  for some of the  $i$  from  $[1, nbDims]$  interval.

## 2.5. Data Layout Formats

This section describes how cuDNN Tensors are arranged in memory. See [cudnnTensorFormat\\_t](#) for enumerated Tensor format types.

### 2.5.1. Example

Consider a batch of images in 4D with the following dimensions:

- ▶ **N**, the batch size, is 1
- ▶ **C**, the number of feature maps (i.e., number of channels), is 64
- ▶ **H**, the image height, is 5, and
- ▶ **W**, the image width, is 4

To keep the example simple, the image pixel elements are expressed as a sequence of integers, 0, 1, 2, 3, and so on. See [Figure 1](#).

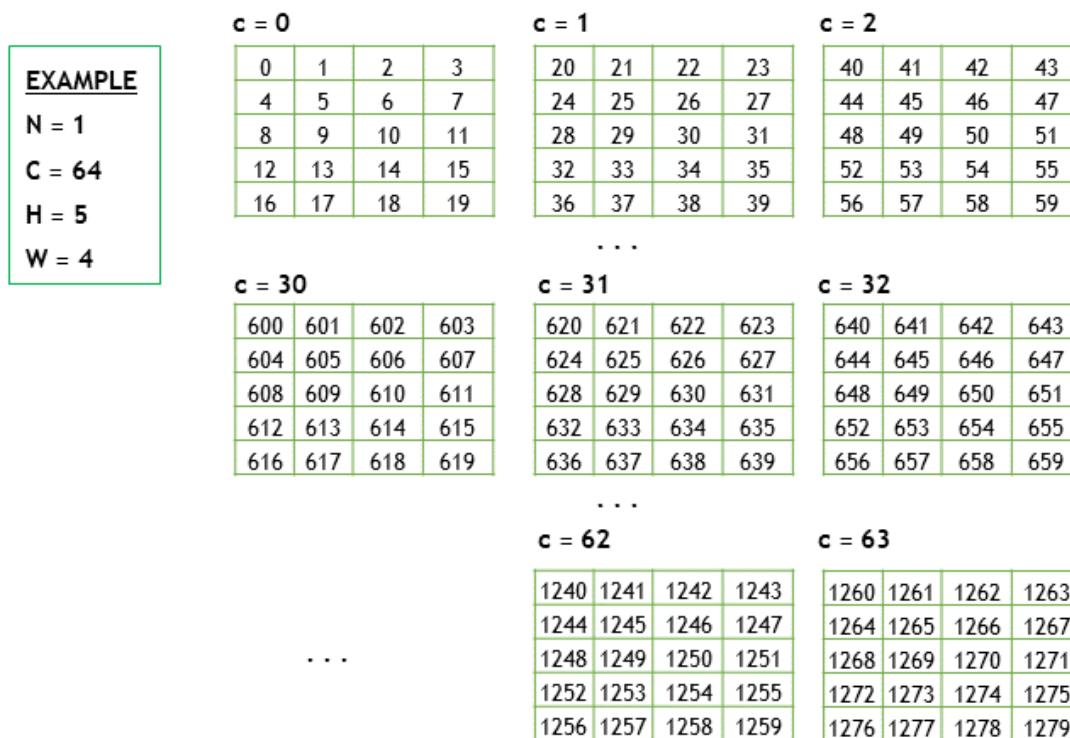

Figure 1 Example with N=1, C=64, H=5, W=4.

## 2.5.2. NCHW Memory Layout

The above 4D Tensor is laid out in the memory in the NCHW format as below:

1. Beginning with the first channel ( $c=0$ ), the elements are arranged contiguously in row-major order.
2. Continue with second and subsequent channels until the elements of all the channels are laid out.

See [Figure 2](#).

3. Proceed to the next batch (if  $N$  is  $> 1$ ).

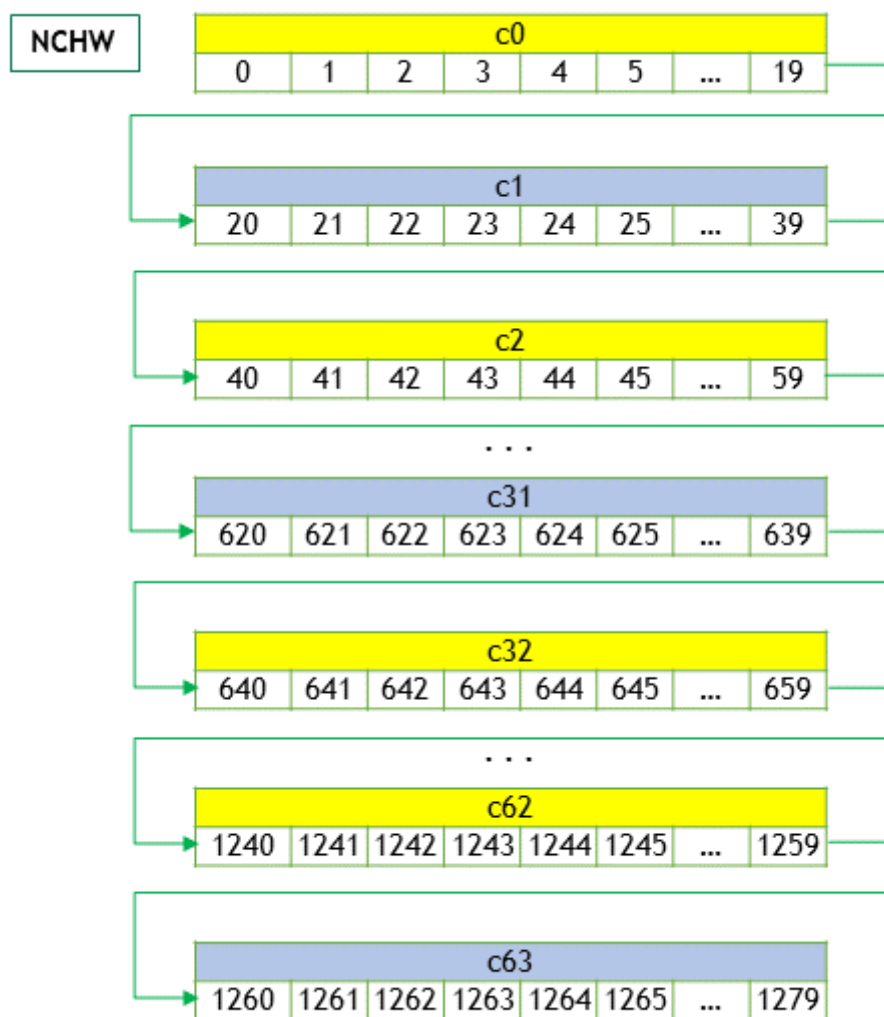

Figure 2 NCHW Memory Layout

### 2.5.3. NHWC Memory Layout

For the NHWC memory layout, the corresponding elements in all the C channels are laid out first, as below:

1. Begin with the first element of channel 0, then proceed to the first element of channel 1, and so on, until the first elements of all the C channels are laid out.
2. Next, select the second element of channel 0, then proceed to the second element of channel 1, and so on, until the second element of all the channels are laid out.
3. Follow the row-major order in channel 0 and complete all the elements. See [Figure 3](#).
4. Proceed to the next batch (if N is > 1).

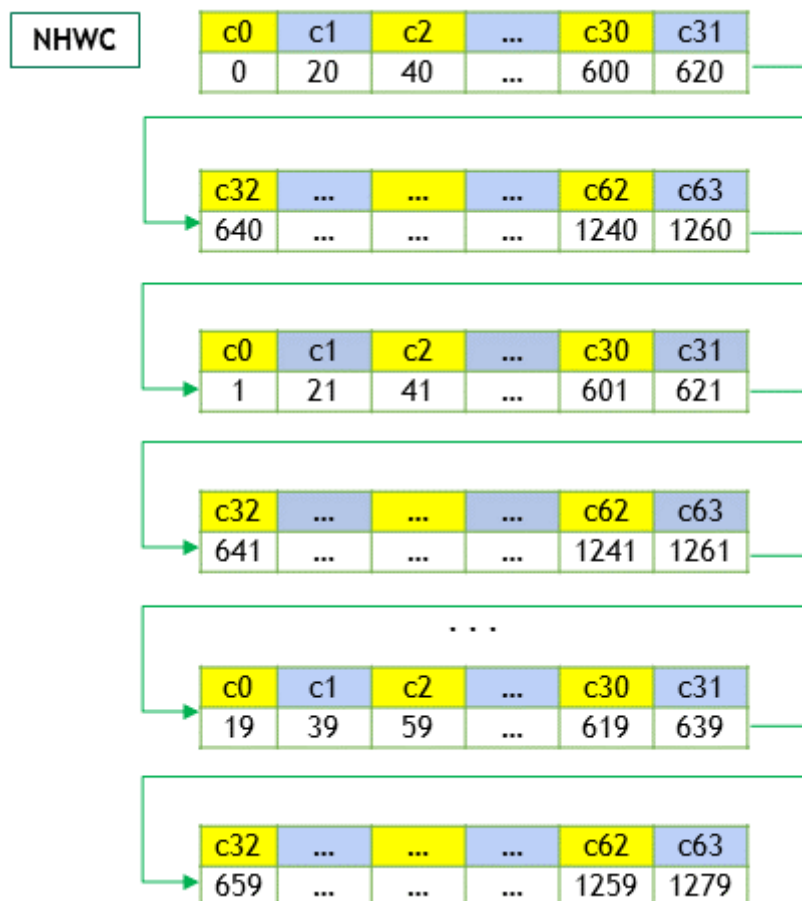

Figure 3 NHWC Memory Layout

## 2.5.4. NC/32HW32 Memory Layout

The NC/32HW32 is similar to NHWC, with a key difference. For the NC/32HW32 memory layout, the 64 channels are grouped into two groups of 32 channels each—first group consisting of channels c0 through c31, and the second group consisting of channels c32 through c63. Then each group is laid out using the NHWC format. See Figure 4.

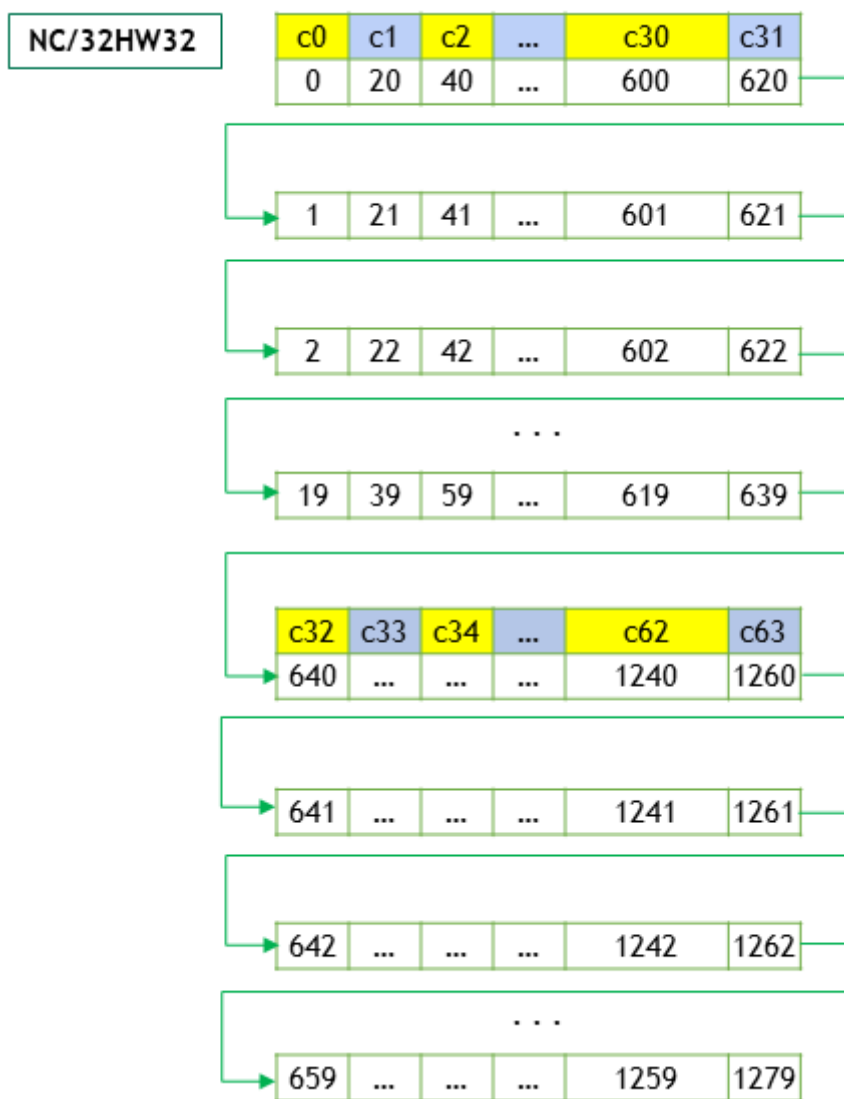

Figure 4 NC/32HW32 Memory Layout

For the generalized NC/xHWx layout format, the following observations apply:

- ▶ Only the channel dimension,  $C$ , is grouped into  $x$  channels each.
- ▶ When  $x = 1$ , each group has only one channel. Hence, the elements of one channel (i.e., one group) are arranged contiguously (in the row-major order), before proceeding to the next group (i.e., next channel). This is the same as NCHW format.
- ▶ When  $x = C$ , then NC/xHWx is identical to NHWC, i.e., the entire channel depth  $C$  is considered as a single group. The case  $x = C$  can be thought of as vectorizing entire  $C$  dimension as one big vector, laying out all the  $C$ s, followed by the remaining dimensions, just like NHWC.
- ▶ The tensor format `CUDNN_TENSOR_NCHW_VECT_C` can also be interpreted in the following way: The NCHW INT8x32 format is really  $N \times (C/32) \times H \times W \times 32$  (32

Cs for every W), just as the NCHW INT8x4 format is  $N \times (C/4) \times H \times W \times 4$  (4 Cs for every W). Hence the "VECT\_C" name - each W is a vector (4 or 32) of Cs.

## 2.6. Thread Safety

The library is thread safe and its functions can be called from multiple host threads, as long as threads do not share the same cuDNN handle simultaneously.

## 2.7. Reproducibility (determinism)

By design, most of cuDNN's routines from a given version generate the same bit-wise results across runs when executed on GPUs with the same architecture and the same number of SMs. However, bit-wise reproducibility is not guaranteed across versions, as the implementation of a given routine may change. With the current release, the following routines do not guarantee reproducibility because they use atomic operations:

- ▶ `cuda::cudnnConvolutionBackwardFilter` when `CUDNN_CONVOLUTION_BWD_FILTER_ALGO_0` or `CUDNN_CONVOLUTION_BWD_FILTER_ALGO_3` is used
- ▶ `cuda::cudnnConvolutionBackwardData` when `CUDNN_CONVOLUTION_BWD_DATA_ALGO_0` is used
- ▶ `cuda::cudnnPoolingBackward` when `CUDNN_POOLING_MAX` is used
- ▶ `cuda::cudnnSpatialTfSamplerBackward`

## 2.8. Scaling Parameters

Many cuDNN routines like `cuda::cudnnConvolutionForward` accept pointers in host memory to scaling factors `alpha` and `beta`. These scaling factors are used to blend the computed values with the prior values in the destination tensor as follows (see [Figure 5](#)):

```
dstValue = alpha*computedValue + beta*priorDstValue.
```



The `dstValue` is written to after being read.

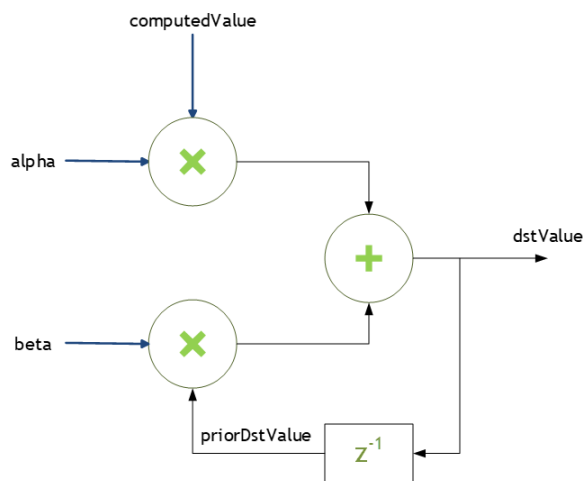

Figure 5 Scaling Parameters for Convolution

When **beta** is zero, the output is not read and may contain uninitialized data (including NaN).

These parameters are passed using a host memory pointer. The storage data types for **alpha** and **beta** are:

- ▶ **float** for HALF and FLOAT tensors, and
- ▶ **double** for DOUBLE tensors.



For improved performance use **beta** = 0.0. Use a non-zero value for beta only when you need to blend the current output tensor values with the prior values of the output tensor.

### Type Conversion

When the data input **x**, the filter input **w** and the output **y** are all in INT8 data type, the function `cudaConvolutionBiasActivationForward()` will perform the type conversion as shown in Figure 6:



Accumulators are 32-bit integers which wrap on overflow.

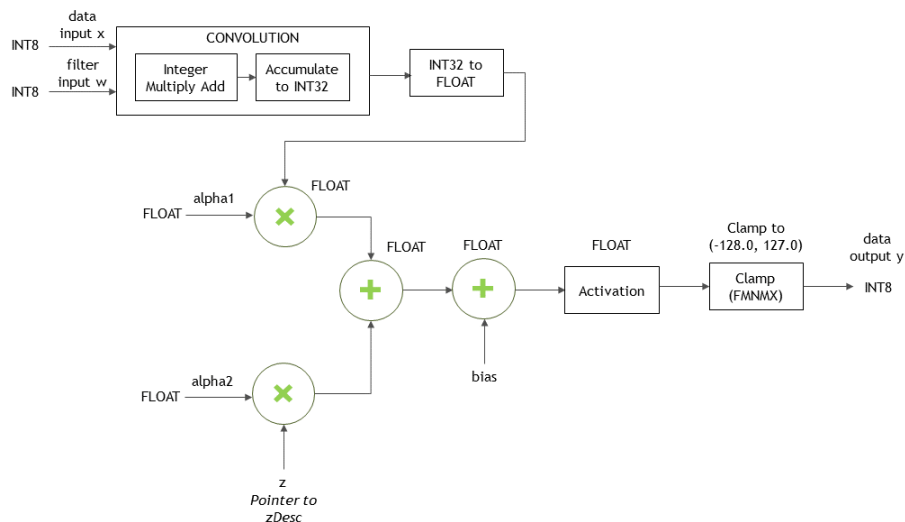

Figure 6 INT8 for cudnnConvolutionBiasActivationForward

## 2.9. Tensor Core Operations

The cuDNN v7 library introduced the acceleration of compute-intensive routines using Tensor Core hardware on supported GPU SM versions. Tensor core operations are supported on the Volta and Turing GPU families.

### 2.9.1. Basics

Tensor core operations perform parallel floating point accumulation of multiple floating point product terms. Setting the math mode to `CUDNN_TENSOR_OP_MATH` via the `cudnnMathType_t` enumerator indicates that the library will use Tensor Core operations. This enumerator specifies the available options to enable the Tensor Core, and should be applied on a per-routine basis.

The default math mode is `CUDNN_DEFAULT_MATH`, which indicates that the Tensor Core operations will be avoided by the library. Because the `CUDNN_TENSOR_OP_MATH` mode uses the Tensor Cores, it is possible that these two modes generate slightly different numerical results due to different sequencing of the floating point operations.

For example, the result of multiplying two matrices using Tensor Core operations is very close to, but not always identical, the result achieved using a sequence of scalar floating point operations. For this reason, the cuDNN library requires an explicit user opt-in before enabling the use of Tensor Core operations.

However, experiments with training common deep learning models show negligible differences between using Tensor Core operations and scalar floating point paths, as



measured by both the final network accuracy and the iteration count to convergence. Consequently, the cuDNN library treats both modes of operation as functionally indistinguishable, and allows for the scalar paths to serve as legitimate fallbacks for cases in which the use of Tensor Core operations is unsuitable.

Kernels using Tensor Core operations are available for both convolutions and RNNs.

See also [Training with Mixed Precision](#).

## 2.9.2. Convolution Functions

### 2.9.2.1. Prerequisite

For the supported GPUs, the Tensor Core operations will be triggered for convolution functions only when `cudaSetConvolutionMathType` is called on the appropriate convolution descriptor by setting the `mathType` to `CUDNN_TENSOR_OP_MATH` or `CUDNN_TENSOR_OP_MATH_ALLOW_CONVERSION`.

### 2.9.2.2. Supported Algorithms

When the prerequisite is met, the below convolution functions can be run as Tensor Core operations:

- ▶ `cudaConvolutionForward`
- ▶ `cudaConvolutionBackwardData`
- ▶ `cudaConvolutionBackwardFilter`

See the table below for supported algorithms:

Supported Convolution Function	Supported Algos
<code>cudaConvolutionForward</code>	- <code>CUDNN_CONVOLUTION_FWD_ALGO_IMPLICIT_PRECOMP_GEMM</code> , - <code>CUDNN_CONVOLUTION_FWD_ALGO_WINOGRAD_NONFUSED</code>
<code>cudaConvolutionBackwardData</code>	- <code>CUDNN_CONVOLUTION_BWD_DATA_ALGO_1</code> , - <code>CUDNN_CONVOLUTION_BWD_DATA_ALGO_WINOGRAD_NONFUSED</code>
<code>cudaConvolutionBackwardFilter</code>	- <code>CUDNN_CONVOLUTION_BWD_FILTER_ALGO_1</code> , - <code>CUDNN_CONVOLUTION_BWD_FILTER_ALGO_WINOGRAD_NONFUSED</code>

### 2.9.2.3. Data and Filter Formats

The cuDNN library may use padding, folding, and NCHW-to-NHWC transformations to call the Tensor Core operations. See [Tensor Transformations](#).

For algorithms other than `*_ALGO_WINOGRAD_NONFUSED`, when the following requirements are met, the cuDNN library will trigger the Tensor Core operations:

- ▶ Input, filter, and output descriptors (`xDesc`, `yDesc`, `wDesc`, `dxDesc`, `dyDesc` and `dwDesc` as applicable) are of the `dataType = CUDNN_DATA_HALF` (i.e., FP16). For FP32 `dataType` see [FP32-to-FP16 Conversion](#).

- ▶ The number of input and output feature maps (i.e., channel dimension **C**) is a multiple of 8. When the channel dimension is not a multiple of 8, see [Padding](#).
- ▶ The filter is of type CUDNN\_TENSOR\_NCHW or CUDNN\_TENSOR\_NHWC.
- ▶ If using a filter of type CUDNN\_TENSOR\_NHWC, then: the input, filter, and output data pointers (**x**, **y**, **w**, **dx**, **dy**, and **dw** as applicable) are aligned to 128-bit boundaries.

## 2.9.3. RNN Functions

### 2.9.3.1. Prerequisite

Tensor core operations will be triggered for these RNN functions only when `cudaSetRNNMatrixMathType` is called on the appropriate RNN descriptor setting `mathType` to CUDNN\_TENSOR\_OP\_MATH or CUDNN\_TENSOR\_OP\_MATH\_ALLOW\_CONVERSION.

### 2.9.3.2. Supported Algorithms

When the above prerequisite is met, the RNN functions below can be run as Tensor Core operations:

- ▶ `cudaRNNForwardInference`
- ▶ `cudaRNNForwardTraining`
- ▶ `cudaRNNBackwardData`
- ▶ `cudaRNNBackwardWeights`
- ▶ `cudaRNNForwardInferenceEx`
- ▶ `cudaRNNForwardTrainingEx`
- ▶ `cudaRNNBackwardDataEx`
- ▶ `cudaRNNBackwardWeightsEx`

See the table below for the supported algorithms:

RNN Function	Support Algos
All RNN functions that support Tensor Core operations	-CUDNN_RNN_ALGO_STANDARD -CUDNN_RNN_ALGO_PERSIST_STATIC (new for cuDNN 7.1)

### 2.9.3.3. Data and Filter Formats

When the following requirements are met, then the cuDNN library will trigger the Tensor Core operations:

- ▶ For algo = CUDNN\_RNN\_ALGO\_STANDARD:
  - ▶ The hidden state size, input size and the batch size is a multiple of 8.
  - ▶ All user-provided tensors, workspace, and reserve space are aligned to 128 bit boundaries.
  - ▶ For FP16 input/output, the CUDNN\_TENSOR\_OP\_MATH or CUDNN\_TENSOR\_OP\_MATH\_ALLOW\_CONVERSION is selected.
  - ▶ For FP32 input/output, CUDNN\_TENSOR\_OP\_MATH\_ALLOW\_CONVERSION is selected.

- ▶ For algo = CUDNN\_RNN\_ALGO\_PERSIST\_STATIC:
  - ▶ The hidden state size and the input size is a multiple of 32.
  - ▶ The batch size is a multiple of 8.
  - ▶ If the batch size exceeds 96 (for forward training or inference) or 32 (for backward data), then the batch sizes constraints may be stricter, and large power-of-two batch sizes may be needed. (new for 7.1).
  - ▶ All user-provided tensors, workspace, and reserve space are aligned to 128 bit boundaries.
  - ▶ For FP16 input/output, CUDNN\_TENSOR\_OP\_MATH or CUDNN\_TENSOR\_OP\_MATH\_ALLOW\_CONVERSION is selected.
  - ▶ For FP32 input/output, CUDNN\_TENSOR\_OP\_MATH\_ALLOW\_CONVERSION is selected.

See also [Features of RNN Functions](#).

## 2.9.4. Tensor Transformations

A few functions in the cuDNN library will perform transformations such as folding, padding, and NCHW-to-NHWC conversion while performing the actual function operation. See below.

### 2.9.4.1. FP16 Data

Tensor Cores operate on FP16 input data with FP32 accumulation. The FP16 multiply leads to a full-precision result that is accumulated in FP32 operations with the other products in a given dot product for a matrix with  $m \times n \times k$  dimensions. See [Figure 7](#).

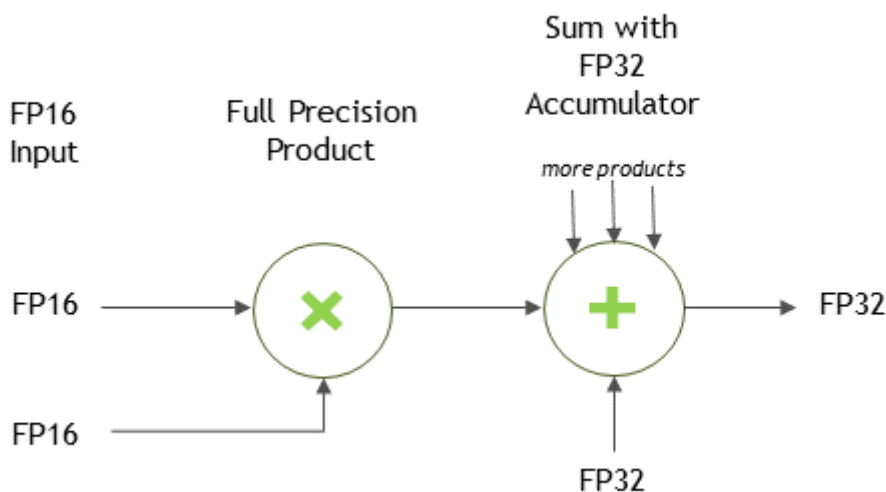

Figure 7 Tensor Operation with FP16 Inputs

### 2.9.4.2. FP32-to-FP16 Conversion

The cuDNN API allows the user to specify that FP32 input data may be copied and converted to FP16 data internally to use Tensor Core Operations for potentially improved performance. This can be achieved by selecting `CUDNN_TENSOR_OP_MATH_ALLOW_CONVERSION` enum for  `cudnnMathType_t`. In this mode, the FP32 Tensors are internally down-converted to FP16, the Tensor Op math is performed, and finally up-converted to FP32 as outputs. See Figure 8.

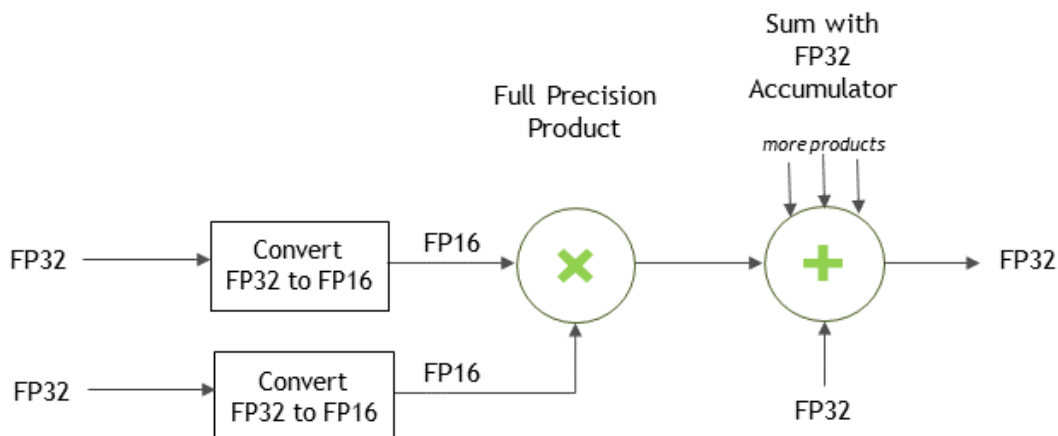

Figure 8 Tensor Operation with FP32 Inputs

#### For Convolutions:

For convolutions, the FP32-to-FP16 conversion can be achieved by passing the `CUDNN_TENSOR_OP_MATH_ALLOW_CONVERSION` enum value to the  `cudnnSetConvolutionMathType()` call. See the below code snippet:

```
// Set the math type to allow cuDNN to use Tensor Cores:
checkCudnnErr(cudnnSetConvolutionMathType(cudnnConvDesc,
    CUDNN_TENSOR_OP_MATH_ALLOW_CONVERSION));
```

#### For RNNs:

For RNNs, the FP32-to-FP16 conversion can be achieved by passing the `CUDNN_TENSOR_OP_MATH_ALLOW_CONVERSION` enum value to the  `cudnnSetRNNMatrixMathType()` call to allow FP32 data to be converted for use in RNNs. See the below code snippet example:

```
// Set the math type to allow cuDNN to use Tensor Cores:
checkCudnnErr(cudnnSetRNNMatrixMathType(cudnnRnnDesc,
    CUDNN_TENSOR_OP_MATH_ALLOW_CONVERSION));
```

### 2.9.4.3. Padding

For packed NCHW data, when the channel dimension is not a multiple of 8, then the cuDNN library will pad the tensors as needed to enable Tensor Core operations. This padding is automatic for packed NCHW data in both the `CUDNN_TENSOR_OP_MATH` and the `CUDNN_TENSOR_OP_MATH_ALLOW_CONVERSION` cases.

The padding occurs with a negligible loss of performance. Hence, the NCHW Tensor dimensions such as below are allowed:

```
// Set NCHW Tensor dimensions, not necessarily as multiples of eight (only the
input tensor is shown here):
int dimA[] = {1, 7, 32, 32};
int strideA[] = {7168, 1024, 32, 1};
```

#### 2.9.4.4. Folding

In the folding operation the cuDNN library implicitly performs the formatting of input tensors and saves the input tensors in an internal workspace. This can lead to an acceleration of the call to Tensor Cores.

Folding enables the input Tensors to be transformed to a format that the Tensor Cores support (i.e., no strides).

#### 2.9.4.5. Conversion Between NCHW and NHWC

Tensor Cores require that the Tensors be in NHWC data layout. Conversion between NCHW and NHWC is performed when the user requests Tensor Op math. However, as stated in [Basics](#), a request to use Tensor Cores is just that, a request, and Tensor Cores may not be used in some cases. The cuDNN library converts between NCHW and NHWC if and only if Tensor Cores are requested and are actually used.

If your input (and output) are NCHW, then expect a layout change. See also for packed NCHW data.

Non-Tensor Op convolutions will not perform conversions between NCHW and NHWC.

In very rare, and difficult-to-qualify, cases that are a complex function of padding and filter sizes, it is possible that Tensor Ops are not enabled. In such cases, users should pre-pad.

#### 2.9.5. Guidelines for a Deep Learning Compiler

For a deep learning compiler, the following are the key guidelines:

- ▶ Make sure that the convolution operation is eligible for Tensor Cores by avoiding any combinations of large padding and large filters.
- ▶ Transform the inputs and filters to NHWC, pre-pad channel and batch size to be a multiple of 8.
- ▶ Make sure that all user-provided tensors, workspace and reserve space are aligned to 128 bit boundaries.

### 2.10. GPU and driver requirements

cuDNN v7.0 supports NVIDIA GPUs of compute capability 3.0 and higher. For x86\_64 platform, cuDNN v7.0 comes with two deliverables: one requires a NVIDIA Driver

compatible with CUDA Toolkit 8.0, the other requires a NVIDIA Driver compatible with CUDA Toolkit 9.0.

If you are using cuDNN with a Volta GPU, version 7 or later is required.

## 2.11. Backward compatibility and deprecation policy

When changing the API of an existing cuDNN function "foo" (usually to support some new functionality), first, a new routine "foo\_v<n>" is created where **n** represents the cuDNN version where the new API is first introduced, leaving "foo" untouched. This ensures backward compatibility with the version **n-1** of cuDNN. At this point, "foo" is considered deprecated, and should be treated as such by users of cuDNN. We gradually eliminate deprecated and suffixed API entries over the course of a few releases of the library per the following policy:

- ▶ In release **n+1**, the legacy API entry "foo" is remapped to a new API "foo\_v<f>" where **f** is some cuDNN version anterior to **n**.
- ▶ Also in release **n+1**, the unsuffixed API entry "foo" is modified to have the same signature as "foo\_v<n>". "foo\_v<n>" is retained as-is.
- ▶ The deprecated former API entry with an anterior suffix **\_v<f>** and new API entry with suffix **\_v<n>** are maintained in this release.
- ▶ In release **n+2**, both suffixed entries of a given entry are removed.

As a rule of thumb, when a routine appears in two forms, one with a suffix and one with no suffix, the non-suffixed entry is to be treated as deprecated. In this case, it is strongly advised that users migrate to the new suffixed API entry to guarantee backwards compatibility in the following cuDNN release. When a routine appears with multiple suffixes, the unsuffixed API entry is mapped to the higher numbered suffix. In that case it is strongly advised to use the non-suffixed API entry to guarantee backward compatibility with the following cuDNN release.

## 2.12. Grouped Convolutions

cuDNN supports grouped convolutions by setting `groupCount > 1` for the convolution descriptor `convDesc`, using `cudaSetConvolutionGroupCount()`.



By default the convolution descriptor `convDesc` is set to `groupCount` of 1.

### Basic Idea

Conceptually, in grouped convolutions the input channels and the filter channels are split into `groupCount` number of independent groups, with each group having a reduced number of channels. Convolution operation is then performed separately on these input and filter groups.

For example, consider the following: if the number of input channels is 4, and the number of filter channels of 12. For a normal, ungrouped convolution, the number of computation operations performed are  $12 \times 4$ .

If the `groupCount` is set to 2, then there are now two input channel groups of two input channels each, and two filter channel groups of six filter channels each.

As a result, each grouped convolution will now perform  $2 \times 6$  computation operations, and two such grouped convolutions are performed. Hence the computation savings are  $2 \times: (12 \times 4) / (2 \times (2 \times 6))$

### cuDNN Grouped Convolution

- ▶ When using `groupCount` for grouped convolutions, you must still define all tensor descriptors so that they describe the size of the entire convolution, instead of specifying the sizes per group.
- ▶ Grouped convolutions are supported for all formats that are currently supported by the functions `cuDNNConvolutionForward()`, `cudaDnnConvolutionBackwardData()` and `cudaDnnConvolutionBackwardFilter()`.
- ▶ The tensor stridings that are set for `groupCount` of 1 are also valid for any group count.
- ▶ By default the convolution descriptor `convDesc` is set to `groupCount` of 1.



See [Convolution Formulas](#) for the math behind the cuDNN Grouped Convolution.

### Example

Below is an example showing the dimensions and strides for grouped convolutions for NCHW format, for 2D convolution.



Note that the symbols "\*" and "/" are used to indicate multiplication and division.

`xDesc` or `dxDesc`:

- ▶ Dimensions: `[batch_size, input_channel, x_height, x_width]`
- ▶ Strides: `[input_channels*x_height*x_width, x_height*x_width, x_width, 1]`

`wDesc` or `dwDesc`:

- ▶ Dimensions: `[output_channels, input_channels/groupCount, w_height, w_width]`
- ▶ Format: NCHW

`convDesc`:

- ▶ Group Count: `groupCount`

`yDesc` or `dyDesc`:

- ▶ **Dimensions:** [batch\_size, output\_channels, y\_height, y\_width]
- ▶ **Strides:** [output\_channels\*y\_height\*y\_width, y\_height\*y\_width, y\_width, 1]

## 2.13. API Logging

cuDNN API logging is a tool that records all input parameters passed into every cuDNN API function call. This functionality is disabled by default, and can be enabled through methods described in this section.

The log output contains variable names, data types, parameter values, device pointers, process ID, thread ID, cuDNN handle, cuda stream ID, and metadata such as time of the function call in microseconds.

When logging is enabled, the log output will be handled by the built-in default callback function. The user may also write their own callback function, and use the `cudaSetCallback` to pass in the function pointer of their own callback function. The following is a sample output of the API log.

```
Function cudnnSetActivationDescriptor() called:
mode: type=cudnnActivationMode_t; val=CUDNN_ACTIVATION_RELU (1);
reluNanOpt: type=cudnnNanPropagation_t; val=CUDNN_NOT_PROPAGATE_NAN (0);
coef: type=double; val=1000.000000;
Time: 2017-11-21T14:14:21.366171 (0d+0h+1m+5s since start)
Process: 21264, Thread: 21264, cudnn_handle: NULL, cudnn_stream: NULL.
```

There are two methods to enable API logging.

### Method 1: Using Environment Variables

To enable API logging using environment variables, follow these steps:

- ▶ Set the environment variable `CUDNN_LOGINFO_DBG` to "1", and
- ▶ Set the environment variable `CUDNN_LOGDEST_DBG` to one of the following:
  - ▶ `stdout`, `stderr`, or a user-desired file path, for example, `/home/username1/log.txt`.
- ▶ Include the conversion specifiers in the file name. For example:
  - ▶ To include date and time in the file name, use the date and time conversion specifiers: `log_%Y_%m_%d_%H_%M_%S.txt`. The conversion specifiers will be automatically replaced with the date and time when the program is initiated, resulting in `log_2017_11_21_09_41_00.txt`.
  - ▶ To include the process id in the file name, use the `%i` conversion specifier: `log_%Y_%m_%d_%H_%M_%S_%i.txt` for the result: `log_2017_11_21_09_41_00_21264.txt` when the process id is 21264. When



you have several processes running, using the process id conversion specifier will prevent these processes writing to the same file at the same time.



The supported conversion specifiers are similar to the `strftime` function.

If the file already exists, the log will overwrite the existing file.



These environmental variables are only checked once at the initialization. Any subsequent changes in these environmental variables will not be effective in the current run. Also note that these environment settings can be overridden by the Method 2 below.

See also [Table 1](#) for the impact on performance of API logging using environment variables.

**Table 1** API Logging Using Environment Variables

Environment variables	CUDNN_LOGINFO_DBG=0	CUDNN_LOGINFO_DBG=1
CUDNN_LOGDEST_DBG not set	- No logging output - No performance loss	- No logging output - No performance loss
CUDNN_LOGDEST_DBG=NULL	- No logging output - No performance loss	- No logging output - No performance loss
CUDNN_LOGDEST_DBG=stdout or stderr	- No logging output - No performance loss	- Logging to <code>stdout</code> or <code>stderr</code> - Some performance loss
CUDNN_LOGDEST_DBG= filename.txt	- No logging output - No performance loss	- Logging to <code>filename.txt</code> - Some performance loss

## Method 2

Method 2: To use API function calls to enable API logging, refer to the API description of [`cudaSetCallback\(\)`](#) and [`cudaGetCallback\(\)`](#).

## 2.14. Features of RNN Functions

The RNN functions are:

- ▶ [`cudaRNNForwardInference`](#)
- ▶ [`cudaRNNForwardTraining`](#)
- ▶ [`cudaRNNBackwardData`](#)

- ▶ cudnnRNNBackwardWeights
- ▶ cudnnRNNForwardInferenceEx
- ▶ cudnnRNNForwardTrainingEx
- ▶ cudnnRNNBackwardDataEx
- ▶ cudnnRNNBackwardWeightsEx

See the table below for a list of features supported by each RNN function:

 For each of these terms, the short-form versions shown in the paranthesis are used in the tables below for brevity: `CUDNN_RNN_ALGO_STANDARD` (`_ALGO_STANDARD`), `CUDNN_RNN_ALGO_PERSIST_STATIC` (`_ALGO_PERSIST_STATIC`), `CUDNN_RNN_ALGO_PERSIST_DYNAMIC` (`_ALGO_PERSIST_DYNAMIC`), and `CUDNN_TENSOR_OP_MATH_ALLOW_CONVERSION` (`_ALLOW_CONVERSION`).

Functions	Input output layout supported	Supports variable sequence length in batch	Commonly supported
<code>cudnnRNNForwardInference</code>	Only Sequence major, packed (non-padded)	Only with <code>_ALGO_STANDARD</code>  Require input sequences descending sorted according to length	Mode (cell type) supported: <code>CUDNN_RNN_RELU</code> , <code>CUDNN_RNN_TANH</code> ,  <code>CUDNN_LSTM</code> , <code>CUDNN_GRU</code>  Also supported* (see the table below for an elaboration on these algorithms):
<code>cudnnRNNForwardTraining</code>			
<code>cudnnRNNBackwardData</code>			
<code>cudnnRNNBackwardWeights</code>			
<code>cudnnRNNForwardInferenceEx</code>	Sequence major unpacked,  Batch major unpacked**,  Sequence major packed**	Only with <code>_ALGO_STANDARD</code>  For unpacked layout**, no input sorting required.  For packed layout, require input sequences descending sorted according to length	<code>_ALGO_STANDARD</code> , <code>_ALGO_PERSIST_STATIC</code> , <code>_ALGO_PERSIST_DYNAMIC</code>  Math mode supported: <code>CUDNN_DEFAULT_MATH</code> ,  <code>CUDNN_TENSOR_OP_MATH</code> (will automatically fall back if run on pre-Volta or if algo doesn't support Tensor Cores)  <code>_ALLOW_CONVERSION</code> (may do down conversion to utilize Tensor Cores)  Direction mode supported: <code>CUDNN_UNIDIRECTIONAL</code> ,  <code>CUDNN_BIDIRECTIONAL</code>  RNN input mode: <code>CUDNN_LINEAR_INPUT</code> , <code>CUDNN_SKIP_INPUT</code>
<code>cudnnRNNForwardTrainingEx</code>			
<code>cudnnRNNBackwardDataEx</code>			
<code>cudnnRNNBackwardWeightsEx</code>			

\* Do not mix different algos for different steps of training. It's also not recommended to mix non-extended and extended API for different steps of training.

\*\* To use unpacked layout, user need to set `CUDNN_RNN_PADDED_IO_ENABLED` through `cudaSetRNNPaddingMode`.

The following table provides the features supported by the algorithms referred in the above table: `CUDNN_RNN_ALGO_STANDARD`, `CUDNN_RNN_ALGO_PERSIST_STATIC`, and `CUDNN_RNN_ALGO_PERSIST_DYNAMIC`.

Features	<code>_ALGO_STANDARD</code>	<code>_ALGO_PERSIST_STATIC</code>	<code>_ALGO_PERSIST_DYNAMIC</code>
Half input Single accumulation Half output	Supported Half intermediate storage Single accumulation		
Single input Single accumulation Single output	Supported If running on Volta, with <code>CUDNN_TENSOR_OP_MATH_ALLOW_CONVERSION</code> <sup>1</sup> , will down-convert and use half intermediate storage. Otherwise: Single intermediate storage Single accumulation		
Double input Double accumulation Double output	Supported Double intermediate storage Double accumulation	Not Supported	Supported Double intermediate storage Double accumulation
LSTM recurrent projection	Supported	Not Supported	Not Supported
LSTM cell clipping	Supported		
Variable sequence length in batch	Supported	Not Supported	Not Supported
Tensor Cores on Volta/ Xavier	Supported For half input/output, acceleration requires setting <code>CUDNN_TENSOR_OP_MATH</code> <sup>1</sup> or <code>CUDNN_TENSOR_OP_MATH_ALLOW_CONVERSION</code> <sup>1</sup> Acceleration requires <code>inputSize</code> and <code>hiddenSize</code> to be multiple of 8 For single input/output, acceleration requires setting <code>CUDNN_TENSOR_OP_MATH_ALLOW_CONVERSION</code> <sup>1</sup> Acceleration requires <code>inputSize</code> and <code>hiddenSize</code> to be multiple of 8		Not Supported, will execute normally ignoring <code>CUDNN_TENSOR_OP_MATH</code> <sup>1</sup> or <code>_ALLOW_CONVERSION</code> <sup>1</sup>

Other limitations		Max problem size is limited by GPU specifications.	Requires real time compilation through NVRTC
-------------------	--	--	--

`CUDNN_TENSOR_OP_MATH` or `CUDNN_TENSOR_OP_MATH_ALLOW_CONVERSION` can be set through `cudaSetRNNMatrixMathType`.

## 2.15. Mixed Precision Numerical Accuracy

When the computation precision and the output precision are not the same, it is possible that the numerical accuracy will vary from one algorithm to the other.

For example, when the computation is performed in FP32 and the output is in FP16, the `CUDNN_CONVOLUTION_BWD_FILTER_ALGO_0` ("ALGO\_0") has lower accuracy compared to the `CUDNN_CONVOLUTION_BWD_FILTER_ALGO_1` ("ALGO\_1"). This is because `ALGO_0` does not use extra workspace, and is forced to accumulate the intermediate results in FP16, i.e., half precision float, and this reduces the accuracy. The `ALGO_1`, on the other hand, uses additional workspace to accumulate the intermediate values in FP32, i.e., full precision float.

# Chapter 3.

## CUDNN DATATYPES REFERENCE

This chapter describes all the types and enums of the cuDNN library API.

### 3.1. cudnnActivationDescriptor\_t

**cudnnActivationDescriptor\_t** is a pointer to an opaque structure holding the description of a activation operation. **cudnnCreateActivationDescriptor()** is used to create one instance, and **cudnnSetActivationDescriptor()** must be used to initialize this instance.

### 3.2. cudnnActivationMode\_t

**cudnnActivationMode\_t** is an enumerated type used to select the neuron activation function used in **cudnnActivationForward()**, **cudnnActivationBackward()** and **cudnnConvolutionBiasActivationForward()**.

#### Values

**CUDNN\_ACTIVATION\_SIGMOID**

Selects the sigmoid function.

**CUDNN\_ACTIVATION\_RELU**

Selects the rectified linear function.

**CUDNN\_ACTIVATION\_TANH**

Selects the hyperbolic tangent function.

**CUDNN\_ACTIVATION\_CLIPPED\_RELU**

Selects the clipped rectified linear function.

**CUDNN\_ACTIVATION\_ELU**

Selects the exponential linear function.

**CUDNN\_ACTIVATION\_IDENTITY** (new for 7.1)

Selects the identity function, intended for bypassing the activation step in `cudaConvolutionBiasActivationForward()`. (The `cudaConvolutionBiasActivationForward()` function must use `CUDNN_CONVOLUTION_FWD_ALGO_IMPLICIT_PRECOMP_GEMM`.) Does not work with `cudaActivationForward()` or `cudaActivationBackward()`.

### 3.3. `cudaAttnDescriptor_t`

`cudaAttnDescriptor_t` is a pointer to an opaque structure holding the description of attention. Use the function `cudaCreateAttnDescriptor` to create one instance, and `cudaDestroyAttnDescriptor` to destroy a previously created descriptor.

### 3.4. `cudaAttnQueryMap_t`

`cudaAttnQueryMap_t` is an enumerated type to select the query mapping type.

Member	Description
<code>CUDNN_ATTN_QUERYMAP_ALL_TO_ONE = 0</code>	When beam width > 1, multiple query sequences are mapped to the same key and value sequences.
<code>CUDNN_ATTN_QUERYMAP_ONE_TO_ONE = 1</code>	When beam width > 1, multiple query sequences are mapped to corresponding key and value sequences.

### 3.5. `cudaBatchNormMode_t`

`cudaBatchNormMode_t` is an enumerated type used to specify the mode of operation in `cudaBatchNormalizationForwardInference()`, `cudaBatchNormalizationForwardTraining()`, `cudaBatchNormalizationBackward()` and `cudaDeriveBNTensorDescriptor()` routines.

#### Values

**CUDNN\_BATCHNORM\_PER\_ACTIVATION**

Normalization is performed per-activation. This mode is intended to be used after non-convolutional network layers. In this mode the tensor dimensions of `bnBias` and `bnScale`, the parameters used in the `cudaBatchNormalization*` functions, are `1xCxHxW`.

**CUDNN\_BATCHNORM\_SPATIAL**

Normalization is performed over N+spatial dimensions. This mode is intended for use after convolutional layers (where spatial invariance is desired). In this mode the `bnBias`, `bnScale` tensor dimensions are `1Cx1x1`.

**CUDNN\_BATCHNORM\_SPATIAL\_PERSISTENT**

This mode is similar to CUDNN\_BATCHNORM\_SPATIAL but it can be faster for some tasks.

An optimized path may be selected for CUDNN\_DATA\_FLOAT and CUDNN\_DATA\_HALF types, compute capability 6.0 or higher for the following two batch normalization API calls: `cudaBatchNormalizationForwardTraining()`, and `cudaBatchNormalizationBackward()`. In the case of `cudaBatchNormalizationBackward()`, the `savedMean` and `savedInvVariance` arguments should not be NULL.

**The rest of this section applies for NCHW mode only:**

This mode may use a scaled atomic integer reduction that is deterministic but imposes more restrictions on the input data range. When a numerical overflow occurs the algorithm may produce NaN-s or Inf-s (infinity) in output buffers.

When Inf-s/NaN-s are present in the input data, the output in this mode is the same as from a pure floating-point implementation.

For finite but very large input values, the algorithm may encounter overflows more frequently due to a lower dynamic range and emit Inf-s/NaN-s while CUDNN\_BATCHNORM\_SPATIAL will produce finite results. The user can invoke `cudaQueryRuntimeError()` to check if a numerical overflow occurred in this mode.

## 3.6. `cudaBatchNormOps_t`

`cudaBatchNormOps_t` is an enumerated type used to specify the mode of operation in `cudaGetBatchNormalizationForwardTrainingExWorkspaceSize()`, `cudaBatchNormalizationForwardTrainingEx()`, `cudaGetBatchNormalizationBackwardExWorkspaceSize()`, `cudaBatchNormalizationBackwardEx()`, and `cudaGetBatchNormalizationTrainingExReserveSpaceSize()` functions.

### Values

#### **CUDNN\_BATCHNORM\_OPS\_BN**

Only batch normalization is performed, per-activation.

#### **CUDNN\_BATCHNORM\_OPS\_BN\_ACTIVATION**

First the batch normalization is performed, and then the activation is performed.

#### **CUDNN\_BATCHNORM\_OPS\_BN\_ADD\_ACTIVATION**

Performs the batch normalization, then element-wise addition, followed by the activation operation.

## 3.7. `cudaConvolutionBwdDataAlgo_t`

**cudaConvolutionBwdDataAlgo\_t** is an enumerated type that exposes the different algorithms available to execute the backward data convolution operation.

### Values

#### **CUDNN\_CONVOLUTION\_BWD\_DATA\_ALGO\_0**

This algorithm expresses the convolution as a sum of matrix product without actually explicitly form the matrix that holds the input tensor data. The sum is done using atomic adds operation, thus the results are non-deterministic.

#### **CUDNN\_CONVOLUTION\_BWD\_DATA\_ALGO\_1**

This algorithm expresses the convolution as a matrix product without actually explicitly form the matrix that holds the input tensor data. The results are deterministic.

#### **CUDNN\_CONVOLUTION\_BWD\_DATA\_ALGO\_FFT**

This algorithm uses a Fast-Fourier Transform approach to compute the convolution. A significant memory workspace is needed to store intermediate results. The results are deterministic.

#### **CUDNN\_CONVOLUTION\_BWD\_DATA\_ALGO\_FFT\_TILING**

This algorithm uses the Fast-Fourier Transform approach but splits the inputs into tiles. A significant memory workspace is needed to store intermediate results but less than **CUDNN\_CONVOLUTION\_BWD\_DATA\_ALGO\_FFT** for large size images. The results are deterministic.

#### **CUDNN\_CONVOLUTION\_BWD\_DATA\_ALGO\_WINOGRAD**

This algorithm uses the Winograd Transform approach to compute the convolution. A reasonably sized workspace is needed to store intermediate results. The results are deterministic.

#### **CUDNN\_CONVOLUTION\_BWD\_DATA\_ALGO\_WINOGRAD\_NONFUSED**

This algorithm uses the Winograd Transform approach to compute the convolution. Significant workspace may be needed to store intermediate results. The results are deterministic.

## 3.8. cudaConvolutionBwdDataAlgoPerf\_t

**cudaConvolutionBwdDataAlgoPerf\_t** is a structure containing performance results returned by **cudaFindConvolutionBackwardDataAlgorithm()** or heuristic results returned by **cudaGetConvolutionBackwardDataAlgorithm\_v7()**.

### Data Members

#### **cudaConvolutionBwdDataAlgo\_t algo**

The algorithm run to obtain the associated performance metrics.

#### **cudaStatus\_t status**

If any error occurs during the workspace allocation or timing of **cudaConvolutionBackwardData()**, this status will represent



that error. Otherwise, this status will be the return status of `cudaConvolutionBackwardData()`.

- ▶ `CUDNN_STATUS_ALLOC_FAILED` if any error occurred during workspace allocation or if provided workspace is insufficient.
- ▶ `CUDNN_STATUS_INTERNAL_ERROR` if any error occurred during timing calculations or workspace deallocation.
- ▶ Otherwise, this will be the return status of `cudaConvolutionBackwardData()`.

**float time**

The execution time of `cudaConvolutionBackwardData()` (in milliseconds).

**size\_t memory**

The workspace size (in bytes).

**cudaDeterminism\_t determinism**

The determinism of the algorithm.

**cudaMathType\_t mathType**

The math type provided to the algorithm.

**int reserved[3]**

Reserved space for future properties.

## 3.9. cudaConvolutionBwdDataPreference\_t

`cudaConvolutionBwdDataPreference_t` is an enumerated type used by `cudaGetConvolutionBackwardDataAlgorithm()` to help the choice of the algorithm used for the backward data convolution.

### Values

**CUDNN\_CONVOLUTION\_BWD\_DATA\_NO\_WORKSPACE**

In this configuration, the routine

`cudaGetConvolutionBackwardDataAlgorithm()` is guaranteed to return an algorithm that does not require any extra workspace to be provided by the user.

**CUDNN\_CONVOLUTION\_BWD\_DATA\_PREFER\_FASTEST**

In this configuration, the routine

`cudaGetConvolutionBackwardDataAlgorithm()` will return the fastest algorithm regardless how much workspace is needed to execute it.

**CUDNN\_CONVOLUTION\_BWD\_DATA\_SPECIFY\_WORKSPACE\_LIMIT**

In this configuration, the routine

`cudaGetConvolutionBackwardDataAlgorithm()` will return the fastest algorithm that fits within the memory limit that the user provided.

## 3.10. cudnnConvolutionBwdFilterAlgo\_t

`cudnnConvolutionBwdFilterAlgo_t` is an enumerated type that exposes the different algorithms available to execute the backward filter convolution operation.

### Values

#### `CUDNN_CONVOLUTION_BWD_FILTER_ALGO_0`

This algorithm expresses the convolution as a sum of matrix product without actually explicitly form the matrix that holds the input tensor data. The sum is done using atomic adds operation, thus the results are non-deterministic.

#### `CUDNN_CONVOLUTION_BWD_FILTER_ALGO_1`

This algorithm expresses the convolution as a matrix product without actually explicitly form the matrix that holds the input tensor data. The results are deterministic.

#### `CUDNN_CONVOLUTION_BWD_FILTER_ALGO_FFT`

This algorithm uses the Fast-Fourier Transform approach to compute the convolution. Significant workspace is needed to store intermediate results. The results are deterministic.

#### `CUDNN_CONVOLUTION_BWD_FILTER_ALGO_3`

This algorithm is similar to `CUDNN_CONVOLUTION_BWD_FILTER_ALGO_0` but uses some small workspace to precomputes some indices. The results are also non-deterministic.

#### `CUDNN_CONVOLUTION_BWD_FILTER_WINOGRAD_NONFUSED`

This algorithm uses the Winograd Transform approach to compute the convolution. Significant workspace may be needed to store intermediate results. The results are deterministic.

#### `CUDNN_CONVOLUTION_BWD_FILTER_ALGO_FFT_TILING`

This algorithm uses the Fast-Fourier Transform approach to compute the convolution but splits the input tensor into tiles. Significant workspace may be needed to store intermediate results. The results are deterministic.

## 3.11. cudnnConvolutionBwdFilterAlgoPerf\_t

`cudnnConvolutionBwdFilterAlgoPerf_t` is a structure containing performance results returned by `cudnnFindConvolutionBackwardFilterAlgorithm()` or heuristic results returned by `cudnnGetConvolutionBackwardFilterAlgorithm_v7()`.

### Data Members

#### `cudnnConvolutionBwdFilterAlgo_t algo`

The algorithm run to obtain the associated performance metrics.

**cudaStatus\_t status**

If any error occurs during the workspace allocation or timing of `cudaConvolutionBackwardFilter()`, this status will represent that error. Otherwise, this status will be the return status of `cudaConvolutionBackwardFilter()`.

- ▶ `CUDA_STATUS_ALLOC_FAILED` if any error occurred during workspace allocation or if provided workspace is insufficient.
- ▶ `CUDA_STATUS_INTERNAL_ERROR` if any error occurred during timing calculations or workspace deallocation.
- ▶ Otherwise, this will be the return status of `cudaConvolutionBackwardFilter()`.

**float time**

The execution time of `cudaConvolutionBackwardFilter()` (in milliseconds).

**size\_t memory**

The workspace size (in bytes).

**cudaDeterminism\_t determinism**

The determinism of the algorithm.

**cudaMathType\_t mathType**

The math type provided to the algorithm.

**int reserved[3]**

Reserved space for future properties.

## 3.12. cudaConvolutionBwdFilterPreference\_t

`cudaConvolutionBwdFilterPreference_t` is an enumerated type used by `cudaGetConvolutionBackwardFilterAlgorithm()` to help the choice of the algorithm used for the backward filter convolution.

**Values****CUDA\_CONVOLUTION\_BWD\_FILTER\_NO\_WORKSPACE**

In this configuration, the routine `cudaGetConvolutionBackwardFilterAlgorithm()` is guaranteed to return an algorithm that does not require any extra workspace to be provided by the user.

**CUDA\_CONVOLUTION\_BWD\_FILTER\_PREFER\_FASTEST**

In this configuration, the routine `cudaGetConvolutionBackwardFilterAlgorithm()` will return the fastest algorithm regardless how much workspace is needed to execute it.

**CUDNN\_CONVOLUTION\_BWD\_FILTER\_SPECIFY\_WORKSPACE\_LIMIT**

In this configuration, the routine

`cudaGetConvolutionBackwardFilterAlgorithm()` will return the fastest algorithm that fits within the memory limit that the user provided.

### 3.13. `cudaConvolutionDescriptor_t`

`cudaConvolutionDescriptor_t` is a pointer to an opaque structure holding the description of a convolution operation. `cudaCreateConvolutionDescriptor()` is used to create one instance, and `cudaSetConvolutionNdDescriptor()` or `cudaSetConvolution2dDescriptor()` must be used to initialize this instance.

### 3.14. `cudaConvolutionFwdAlgo_t`

`cudaConvolutionFwdAlgo_t` is an enumerated type that exposes the different algorithms available to execute the forward convolution operation.

#### Values

**CUDNN\_CONVOLUTION\_FWD\_ALGO\_IMPLICIT\_GEMM**

This algorithm expresses the convolution as a matrix product without actually explicitly form the matrix that holds the input tensor data.

**CUDNN\_CONVOLUTION\_FWD\_ALGO\_IMPLICIT\_PRECOMP\_GEMM**

This algorithm expresses the convolution as a matrix product without actually explicitly form the matrix that holds the input tensor data, but still needs some memory workspace to precompute some indices in order to facilitate the implicit construction of the matrix that holds the input tensor data.

**CUDNN\_CONVOLUTION\_FWD\_ALGO\_GEMM**

This algorithm expresses the convolution as an explicit matrix product. A significant memory workspace is needed to store the matrix that holds the input tensor data.

**CUDNN\_CONVOLUTION\_FWD\_ALGO\_DIRECT**

This algorithm expresses the convolution as a direct convolution (e.g without implicitly or explicitly doing a matrix multiplication).

**CUDNN\_CONVOLUTION\_FWD\_ALGO\_FFT**

This algorithm uses the Fast-Fourier Transform approach to compute the convolution. A significant memory workspace is needed to store intermediate results.

**CUDNN\_CONVOLUTION\_FWD\_ALGO\_FFT\_TILING**

This algorithm uses the Fast-Fourier Transform approach but splits the inputs into tiles. A significant memory workspace is needed to store intermediate results but less than `CUDNN_CONVOLUTION_FWD_ALGO_FFT` for large size images.

**CUDNN\_CONVOLUTION\_FWD\_ALGO\_WINOGRAD**

This algorithm uses the Winograd Transform approach to compute the convolution. A reasonably sized workspace is needed to store intermediate results.

**CUDNN\_CONVOLUTION\_FWD\_ALGO\_WINOGRAD\_NONFUSED**

This algorithm uses the Winograd Transform approach to compute the convolution. Significant workspace may be needed to store intermediate results.

## 3.15. cudnnConvolutionFwdAlgoPerf\_t

**cudnnConvolutionFwdAlgoPerf\_t** is a structure containing performance results returned by **cudnnFindConvolutionForwardAlgorithm()** or heuristic results returned by **cudnnGetConvolutionForwardAlgorithm\_v7()**.

### Data Members

**cudnnConvolutionFwdAlgo\_t algo**

The algorithm run to obtain the associated performance metrics.

**cudnnStatus\_t status**

If any error occurs during the workspace allocation or timing of **cudnnConvolutionForward()**, this status will represent that error. Otherwise, this status will be the return status of **cudnnConvolutionForward()**.

- ▶ **CUDNN\_STATUS\_ALLOC\_FAILED** if any error occurred during workspace allocation or if provided workspace is insufficient.
- ▶ **CUDNN\_STATUS\_INTERNAL\_ERROR** if any error occurred during timing calculations or workspace deallocation.
- ▶ Otherwise, this will be the return status of **cudnnConvolutionForward()**.

**float time**

The execution time of **cudnnConvolutionForward()** (in milliseconds).

**size\_t memory**

The workspace size (in bytes).

**cudnnDeterminism\_t determinism**

The determinism of the algorithm.

**cudnnMathType\_t mathType**

The math type provided to the algorithm.

**int reserved[3]**

Reserved space for future properties.

## 3.16. cudnnConvolutionFwdPreference\_t

`cudaConvolutionFwdPreference_t` is an enumerated type used by `cudaGetConvolutionForwardAlgorithm()` to help the choice of the algorithm used for the forward convolution.

### Values

#### `CUDNN_CONVOLUTION_FWD_NO_WORKSPACE`

In this configuration, the routine `cudaGetConvolutionForwardAlgorithm()` is guaranteed to return an algorithm that does not require any extra workspace to be provided by the user.

#### `CUDNN_CONVOLUTION_FWD_PREFER_FASTEST`

In this configuration, the routine `cudaGetConvolutionForwardAlgorithm()` will return the fastest algorithm regardless how much workspace is needed to execute it.

#### `CUDNN_CONVOLUTION_FWD_SPECIFY_WORKSPACE_LIMIT`

In this configuration, the routine `cudaGetConvolutionForwardAlgorithm()` will return the fastest algorithm that fits within the memory limit that the user provided.

## 3.17. `cudaConvolutionMode_t`

`cudaConvolutionMode_t` is an enumerated type used by `cudaSetConvolutionDescriptor()` to configure a convolution descriptor. The filter used for the convolution can be applied in two different ways, corresponding mathematically to a convolution or to a cross-correlation. (A cross-correlation is equivalent to a convolution with its filter rotated by 180 degrees.)

### Values

#### `CUDNN_CONVOLUTION`

In this mode, a convolution operation will be done when applying the filter to the images.

#### `CUDNN_CROSS_CORRELATION`

In this mode, a cross-correlation operation will be done when applying the filter to the images.

## 3.18. `cudaCTCLossAlgo_t`

`cudaCTCLossAlgo_t` is an enumerated type that exposes the different algorithms available to execute the CTC loss operation.

### Values

#### `CUDNN CTC LOSS ALGO DETERMINISTIC`

Results are guaranteed to be reproducible

#### `CUDNN CTC LOSS ALGO NON DETERMINISTIC`

Results are not guaranteed to be reproducible

## 3.19. cudnnCTCLossDescriptor\_t

`cudnnCTCLossDescriptor_t` is a pointer to an opaque structure holding the description of a CTC loss operation. `cudnnCreateCTCLossDescriptor()` is used to create one instance, `cudnnSetCTCLossDescriptor()` is used to initialize this instance, `cudnnDestroyCTCLossDescriptor()` is used to destroy this instance.

## 3.20. cudnnDataType\_t

`cudnnDataType_t` is an enumerated type indicating the data type to which a tensor descriptor or filter descriptor refers.

### Values

#### `CUDNN_DATA_FLOAT`

The data is 32-bit single-precision floating point (**float**).

#### `CUDNN_DATA_DOUBLE`

The data is 64-bit double-precision floating point (**double**).

#### `CUDNN_DATA_HALF`

The data is 16-bit floating point.

#### `CUDNN_DATA_INT8`

The data is 8-bit signed integer.

#### `CUDNN_DATA_UINT8` (new for 7.1)

The data is 8-bit unsigned integer.

#### `CUDNN_DATA_INT32`

The data is 32-bit signed integer.

#### `CUDNN_DATA_INT8x4`

The data is 32-bit elements each composed of 4 8-bit signed integer. This data type is only supported with tensor format `CUDNN_TENSOR_NCHW_VECT_C`.

#### `CUDNN_DATA_INT8x32`

The data is 32-element vectors, each element being 8-bit signed integer. This data type is only supported with the tensor format `CUDNN_TENSOR_NCHW_VECT_C`. Moreover, this data type can only be used with “algo 1,” i.e., `CUDNN_CONVOLUTION_FWD_ALGO_IMPLICIT_PRECOMP_GEMM`. See [cudnnConvolutionFwdAlgo\\_t](#).

#### `CUDNN_DATA_UINT8x4` (new for 7.1)

The data is 32-bit elements each composed of 4 8-bit unsigned integer. This data type is only supported with tensor format `CUDNN_TENSOR_NCHW_VECT_C`.

## 3.21. cudnnDeterminism\_t

**cudnnDeterminism\_t** is an enumerated type used to indicate if the computed results are deterministic (reproducible). See section 2.5 (Reproducibility) for more details on determinism.

### Values

#### **CUDNN\_NON\_DETERMINISTIC**

Results are not guaranteed to be reproducible

#### **CUDNN\_DETERMINISTIC**

Results are guaranteed to be reproducible

## 3.22. cudnnDirectionMode\_t

**cudnnDirectionMode\_t** is an enumerated type used to specify the recurrence pattern in the **cudnnRNNForwardInference()**, **cudnnRNNForwardTraining()**, **cudnnRNNBackwardData()** and **cudnnRNNBackwardWeights()** routines.

### Values

#### **CUDNN\_UNIDIRECTIONAL**

The network iterates recurrently from the first input to the last.

#### **CUDNN\_BIDIRECTIONAL**

Each layer of the the network iterates recurrently from the first input to the last and separately from the last input to the first. The outputs of the two are concatenated at each iteration giving the output of the layer.

## 3.23. cudnnDivNormMode\_t

**cudnnDivNormMode\_t** is an enumerated type used to specify the mode of operation in **cudnnDivisiveNormalizationForward()** and **cudnnDivisiveNormalizationBackward()**.

### Values

#### **CUDNN\_DIVNORM\_PRECOMPUTED\_MEANS**

The means tensor data pointer is expected to contain means or other kernel convolution values precomputed by the user. The means pointer can also be NULL, in that case it's considered to be filled with zeroes. This is equivalent to spatial LRN. Note that in the backward pass the means are treated as independent inputs and the gradient over means is computed independently. In this mode to yield a net gradient over the entire LCN computational graph the destDiffMeans result should be backpropagated through the user's means layer (which can be



implemented using average pooling) and added to the `destDiffData` tensor produced by `cudaDnnDivisiveNormalizationBackward`.

## 3.24. `cudaDnnDropoutDescriptor_t`

`cudaDnnDropoutDescriptor_t` is a pointer to an opaque structure holding the description of a dropout operation. `cudaDnnCreateDropoutDescriptor()` is used to create one instance, `cudaDnnSetDropoutDescriptor()` is used to initialize this instance, `cudaDnnDestroyDropoutDescriptor()` is used to destroy this instance, `cudaDnnGetDropoutDescriptor()` is used to query fields of a previously initialized instance, `cudaDnnRestoreDropoutDescriptor()` is used to restore an instance to a previously saved off state.

## 3.25. `cudaDnnErrQueryMode_t`

`cudaDnnErrQueryMode_t` is an enumerated type passed to `cudaDnnQueryRuntimeError()` to select the remote kernel error query mode.

### Values

#### `CUDNN_ERRQUERY_RAWCODE`

Read the error storage location regardless of the kernel completion status.

#### `CUDNN_ERRQUERY_NONBLOCKING`

Report if all tasks in the user stream of the cuDNN handle were completed. If that is the case, report the remote kernel error code.

#### `CUDNN_ERRQUERY_BLOCKING`

Wait for all tasks to complete in the user stream before reporting the remote kernel error code.

## 3.26. `cudaDnnFilterDescriptor_t`

`cudaDnnFilterDescriptor_t` is a pointer to an opaque structure holding the description of a filter dataset. `cudaDnnCreateFilterDescriptor()` is used to create one instance, and `cudaDnnSetFilter4dDescriptor()` or `cudaDnnSetFilterNdDescriptor()` must be used to initialize this instance.

## 3.27. `cudaDnnFoldingDirection_t`

`cudaDnnFoldingDirection_t` is an enumerated type used to select the folding direction. See also `cudaDnnTensorTransformDescriptor_t`.

Member	Description
<code>CUDNN_TRANSFORM_FOLD = 0U</code>	Selects folding.
<code>CUDNN_TRANSFORM_UNFOLD = 1U</code>	Selects unfolding.

### 3.28. cudnnFusedOps\_t

The cudnnFusedOps\_t type is an enumerated type to select a specific sequence of computations to perform in the fused operations.

Member	Description
<p>CUDNN_FUSED_SCALE_BIAS_ACTIVATION_CONV_BNSTATS = 0</p>	<p>On a per channel basis, performs these operations in this order: scale, add bias, activation, convolution, and generate batchnorm statistics.</p>
<div style="text-align: center;"> <p>CUDNN_FUSED_SCALE_BIAS_ACTIVATION_CONV_BNSTATS</p> </div>	
<p>CUDNN_FUSED_SCALE_BIAS_ACTIVATION_WGRAD = 1</p>	<p>On a per channel basis, performs these operations in this order: scale, add bias, activation, convolution backward weights, and generate batchnorm statistics.</p>

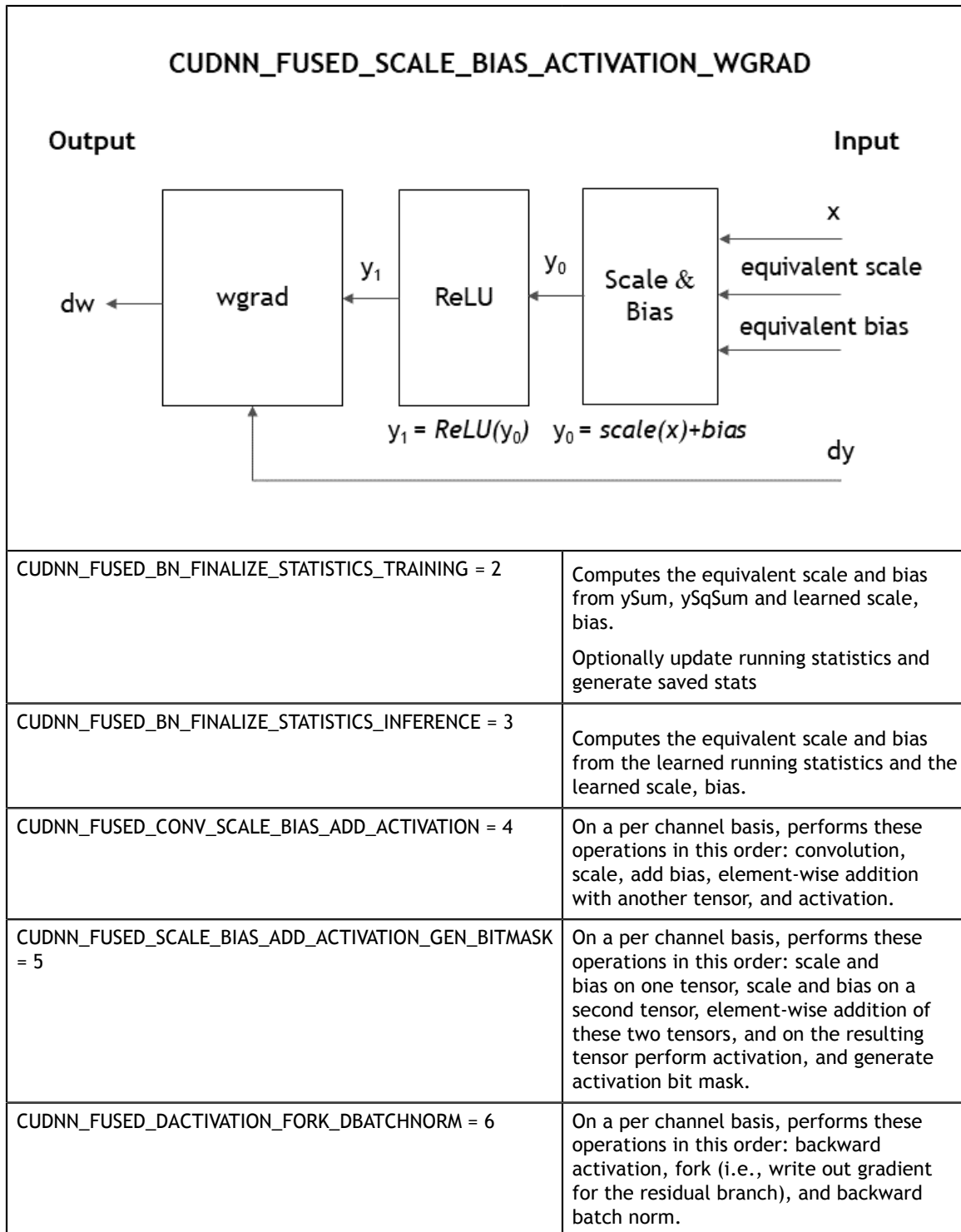

### 3.29. cudnnFusedOpsConstParamLabel\_t

The `cudaFusedOpsConstParamLabel_t` is an enumerated type for the selection of the type of the `cudaFusedOps` descriptor. See also [cudaSetFusedOpsConstParamPackAttribute](#).

```
typedef enum {
    CUDNN_PARAM_XDESC                = 0,
    CUDNN_PARAM_XDATA_PLACEHOLDER   = 1,
    CUDNN_PARAM_BN_MODE              = 2,
    CUDNN_PARAM_BN_EQSCALEBIAS_DESC = 3,
    CUDNN_PARAM_BN_EQSCALE_PLACEHOLDER = 4,
    CUDNN_PARAM_BN_EQBIAS_PLACEHOLDER = 5,
    CUDNN_PARAM_ACTIVATION_DESC     = 6,
    CUDNN_PARAM_CONV_DESC           = 7,
    CUDNN_PARAM_WDESC               = 8,
    CUDNN_PARAM_WDATA_PLACEHOLDER   = 9,
    CUDNN_PARAM_DWDESC              = 10,
    CUDNN_PARAM_DWDATA_PLACEHOLDER  = 11,
    CUDNN_PARAM_YDESC               = 12,
    CUDNN_PARAM_YDATA_PLACEHOLDER   = 13,
    CUDNN_PARAM_DYDESC              = 14,
    CUDNN_PARAM_DYDATA_PLACEHOLDER  = 15,
    CUDNN_PARAM_YSTATS_DESC         = 16,
    CUDNN_PARAM_YSUM_PLACEHOLDER    = 17,
    CUDNN_PARAM_YSQSUM_PLACEHOLDER  = 18,
    CUDNN_PARAM_BN_SCALEBIAS_MEANVAR_DESC = 19,
    CUDNN_PARAM_BN_SCALE_PLACEHOLDER = 20,
    CUDNN_PARAM_BN_BIAS_PLACEHOLDER = 21,
    CUDNN_PARAM_BN_SAVED_MEAN_PLACEHOLDER = 22,
    CUDNN_PARAM_BN_SAVED_INVSTD_PLACEHOLDER = 23,
    CUDNN_PARAM_BN_RUNNING_MEAN_PLACEHOLDER = 24,
    CUDNN_PARAM_BN_RUNNING_VAR_PLACEHOLDER = 25,
    CUDNN_PARAM_ZDESC               = 26,
    CUDNN_PARAM_ZDATA_PLACEHOLDER   = 27,
    CUDNN_PARAM_BN_Z_EQSCALEBIAS_DESC = 28,
    CUDNN_PARAM_BN_Z_EQSCALE_PLACEHOLDER = 29,
    CUDNN_PARAM_BN_Z_EQBIAS_PLACEHOLDER = 30,
    CUDNN_PARAM_ACTIVATION_BITMASK_DESC = 31,
    CUDNN_PARAM_ACTIVATION_BITMASK_PLACEHOLDER = 32,
    CUDNN_PARAM_DXDESC              = 33,
    CUDNN_PARAM_DXDATA_PLACEHOLDER  = 34,
    CUDNN_PARAM_DZDESC              = 35,
    CUDNN_PARAM_DZDATA_PLACEHOLDER  = 36,
    CUDNN_PARAM_BN_DSCALE_PLACEHOLDER = 37,
    CUDNN_PARAM_BN_DBIAS_PLACEHOLDER = 38,
} cudaFusedOpsConstParamLabel_t;
```

Table 2 Legend For Tables in This Section

Short-form used:	Stands for:
Setter	<code>cudaSetFusedOpsConstParamPackAttribute</code>
Getter	<code>cudaGetFusedOpsConstParamPackAttribute</code>
<code>X_PointerPlaceHolder_t</code>	<code>cudaFusedOpsPointerPlaceHolder_t</code>
"X_" prefix in the Attribute column	Stands for "CUDNN_PARAM_" in the enumerator name

Table 3 CUDNN\_FUSED\_SCALE\_BIAS\_ACTIVATION\_CONV\_BNSTATS

For the attribute CUDNN_FUSED_SCALE_BIAS_ACTIVATION_CONV_BNSTATS in cudnnFusedOp_t:			
Attribute	Expected Descriptor Type Passed in, in the Setter	Description	Default Value After Creation
X_XDESC	In the setter the <code>*param</code> should be <code>xDesc</code> , a pointer to a previously initialized <code>cudnnTensorDescriptor_t</code> .	Tensor descriptor describing the size, layout and datatype of the x (input) tensor	NULL
X_XDATA_PLACEHOLDER	In the setter the <code>*param</code> should be a pointer to a previously initialized <code>X_PointerPlaceholder_t</code> .	Describes whether <code>xData</code> pointer in the <code>VariantParamPack</code> will be NULL, or if not, user promised pointer alignment *	CUDNN_PTR_NULL
X_BN_MODE	In the setter the <code>*param</code> should be a pointer to a previously initialized <code>cudnnBatchNormMode_t</code> .	Describes the mode of operation for the scale, bias and the statistics. As of cuDNN 7.6.0, only "CUDNN_BATCHNORM_SPATIAL" and "CUDNN_BATCHNORM_SPATIAL_PERSISTENT" are supported, i.e., scale, bias and statistics are all per-channel.	CUDNN_BATCHNORM_PER_ACTIVATION
X_BN_EQSCALEBIAS_DESC	In the setter the <code>*param</code> should be a pointer to a previously initialized <code>cudnnTensorDescriptor_t</code> .	Tensor descriptor describing the size, layout and datatype of the batchNorm equivalent scale and bias tensors. The shapes must match the mode specified in "CUDNN_PARAM_BN_MODE". If set to NULL, both scale and bias operation will become a NOP.	NULL
X_BN_EQSCALE_PLACEHOLDER	In the setter the <code>*param</code> should be a pointer to a previously initialized <code>X_PointerPlaceholder_t</code> .	Describes whether batchnorm equivalent scale pointer in the <code>VariantParamPack</code> will be NULL, or if not, user promised pointer alignment *.	CUDNN_PTR_NULL

For the attribute CUDNN_FUSED_SCALE_BIAS_ACTIVATION_CONV_BNSTATS in cudnnFusedOp_t:			
Attribute	Expected Descriptor Type Passed in, in the Setter	Description	Default Value After Creation
		If set to CUDNN_PTR_NULL, then the scale operation becomes a NOP.	
X_BN_EQBIAS_PLACEHOLDER	In the setter the <code>*param</code> should be a pointer to a previously initialized <code>X_PointerPlaceholder_t*</code> .	Describes whether batchnorm equivalent bias pointer in the VariantParamPack will be NULL, or if not, user promised pointer alignment *.  If set to CUDNN_PTR_NULL, then the bias operation becomes a NOP.	CUDNN_PTR_NULL
X_ACTIVATION_DESC	In the setter the <code>*param</code> should be a pointer to a previously initialized <code>cudnnActivationDescriptor_t*</code> .	Describes the activation operation.  As of 7.6.0, only activation mode of “CUDNN_ACTIVATION_RELU” and “CUDNN_ACTIVATION_IDENTITY” is supported. If set to NULL or if the activation mode is set to “CUDNN_ACTIVATION_IDENTITY”, then the activation in the op sequence becomes a NOP.	NULL
X_CONV_DESC	In the setter the <code>*param</code> should be a pointer to a previously initialized <code>cudnnConvolutionDescriptor_t*</code> .	Describes the convolution operation.	NULL
X_WDESC	In the setter the <code>*param</code> should be a pointer to a previously initialized <code>cudnnFilterDescriptor_t*</code> .	Filter descriptor describing the size, layout and datatype of the w (filter) tensor.	NULL
X_WDATA_PLACEHOLDER	In the setter the <code>*param</code> should be a pointer to a previously initialized <code>X_PointerPlaceholder_t*</code> .	Describes whether w (filter) tensor pointer in the VariantParamPack will be NULL, or if not,	CUDNN_PTR_NULL

For the attribute CUDNN_FUSED_SCALE_BIAS_ACTIVATION_CONV_BNSTATS in cudnnFusedOp_t:			
Attribute	Expected Descriptor Type Passed in, in the Setter	Description	Default Value After Creation
		user promised pointer alignment *.	
X_YDESC	In the setter the <code>*param</code> should be a pointer to a previously initialized <code>cudnnTensorDescriptor_t*</code> .	Tensor descriptor describing the size, layout and datatype of the y (output) tensor.	NULL
X_YDATA_PLACEHOLDER	In the setter the <code>*param</code> should be a pointer to a previously initialized <code>X_PointerPlaceHolder_t*</code> .	Describes whether y (output) tensor pointer in the <code>VariantParamPack</code> will be NULL, or if not, user promised pointer alignment *.	CUDNN_PTR_NULL
X_YSTATS_DESC	In the setter the <code>*param</code> should be a pointer to a previously initialized <code>cudnnTensorDescriptor_t*</code> .	Tensor descriptor describing the size, layout and datatype of the sum of y and sum of y square tensors. The shapes need to match the mode specified in "CUDNN_PARAM_BN_MODE".  If set to NULL, the y statistics generation operation will be become a NOP.	NULL
X_YSUM_PLACEHOLDER	In the setter the <code>*param</code> should be a pointer to a previously initialized <code>X_PointerPlaceHolder_t*</code> .	Describes whether sum of y pointer in the <code>VariantParamPack</code> will be NULL, or if not, user promised pointer alignment *.  If set to CUDNN_PTR_NULL, the y statistics generation operation will be become a NOP	CUDNN_PTR_NULL
X_YSQSUM_PLACEHOLDER	In the setter the <code>*param</code> should be a pointer to a previously initialized <code>X_PointerPlaceHolder_t*</code> .	Describes whether sum of y square pointer in the <code>VariantParamPack</code> will be NULL, or if not, user promised pointer alignment *.  If set to CUDNN_PTR_NULL, the	CUDNN_PTR_NULL

For the attribute CUDNN_FUSED_SCALE_BIAS_ACTIVATION_CONV_BNSTATS in cudnnFusedOp_t:			
Attribute	Expected Descriptor Type Passed in, in the Setter	Description	Default Value After Creation
		Statistics generation operation will be become a NOP.	



If the corresponding pointer placeholder in ConstParamPack is set to “CUDNN\_PTR\_NULL”, then the device pointer in the VariantParamPack need to be NULL as well.



If the corresponding pointer placeholder in ConstParamPack is set to “CUDNN\_PTR\_ELEM\_ALIGNED” or “CUDNN\_PTR\_16B\_ALIGNED”, then the device pointer in the VariantParamPack may not be NULL and need to be at least element-aligned or 16 bytes-aligned, respectively.

As of cuDNN 7.6.0, if the conditions in the [Table 4](#) are met, then the fully fused fast path will be triggered. Otherwise a slower partially fused path will be triggered.

**Table 4 Conditions for Fully Fused Fast Path (Forward)**

Parameter	Condition
Device compute capability	Need to be one of 7.0, 7.2 or 7.5
CUDNN_PARAM_XDESC CUDNN_PARAM_XDATA_PLACEHOLDER	Tensor is 4 dimensional Datatype is CUDNN_DATA_HALF Layout is NHWC fully packed Alignment is CUDNN_PTR_16B_ALIGNED Tensor’s C dimension is a multiple of 8.
CUDNN_PARAM_BN_EQSCALEBIAS_DESC CUDNN_PARAM_BN_EQSCALE_PLACEHOLDER CUDNN_PARAM_BN_EQBIAS_PLACEHOLDER	If either one of scale and bias operation is not turned into a NOP: Tensor is 4 dimensional with shape 1xCx1x1 Datatype is CUDNN_DATA_HALF Layout is fully packed Alignment is CUDNN_PTR_16B_ALIGNED
CUDNN_PARAM_CONV_DESC CUDNN_PARAM_WDESC CUDNN_PARAM_WDATA_PLACEHOLDER	Convolution descriptor’s mode need to be CUDNN_CROSS_CORRELATION Convolution descriptor’s dataType need to be CUDNN_DATA_FLOAT Convolution descriptor’s dilationA is (1,1) Convolution descriptor’s group count need to be 1



Parameter	Condition
	<p>Convolution descriptor's <code>mathType</code> need to be <code>CUDNN_TENSOR_OP_MATH</code> or <code>CUDNN_TENSOR_OP_MATH_ALLOW_CONVERSION</code></p> <p>Filter is in NHWC layout</p> <p>Filter's data type is <code>CUDNN_DATA_HALF</code></p> <p>Filter's K dimension is a multiple of 32.</p> <p>Filter size RxS is either 1x1 or 3x3</p> <p>If filter size RxS is 1x1, convolution descriptor's <code>padA</code> need to be (0,0) and <code>filterStrideA</code> need to be (1,1)</p> <p>Filter's alignment is <code>CUDNN_PTR_16B_ALIGNED</code></p>
<p><code>CUDNN_PARAM_YDESC</code></p> <p><code>CUDNN_PARAM_YDATA_PLACEHOLDER</code></p>	<p>Tensor is 4 dimensional</p> <p>Datatype is <code>CUDNN_DATA_HALF</code></p> <p>Layout is NHWC fully packed</p> <p>Alignment is <code>CUDNN_PTR_16B_ALIGNED</code></p>
<p><code>CUDNN_PARAM_YSTATS_DESC</code></p> <p><code>CUDNN_PARAM_YSUM_PLACEHOLDER</code></p> <p><code>CUDNN_PARAM_YSQSUM_PLACEHOLDER</code></p>	<p>If the generate statistics operation is not turned into a NOP:</p> <p>Tensor is 4 dimensional with shape 1xKx1x1</p> <p>Datatype is <code>CUDNN_DATA_FLOAT</code></p> <p>Layout is fully packed</p> <p>Alignment is <code>CUDNN_PTR_16B_ALIGNED</code></p>

Table 5 CUDNN\_FUSED\_SCALE\_BIAS\_ACTIVATION\_WGRAD

For the attribute <code>CUDNN_FUSED_SCALE_BIAS_ACTIVATION_WGRAD</code> in <code>cudaFusedOp_t</code> :			
Attribute	Expected Descriptor Type Passed in, in the Setter	Description	Default Value After Creation
<code>X_XDESC</code>	In the setter the <code>*param</code> should be <code>xDesc</code> , a pointer to a previously initialized <code>cudaTensorDescriptor_t</code> .	Tensor descriptor describing the size, layout and datatype of the x (input) tensor	NULL
<code>X_XDATA_PLACEHOLDER</code>	In the setter the <code>*param</code> should be a pointer to a previously initialized <code>X_PointerPlaceholder_t</code> .	Describes whether <code>xData</code> pointer in the <code>VariantParamPack</code> will be NULL, or if not, <code>*userPromisedPointerAlignment</code> *	<code>CUDNN_PTR_NULL</code>
<code>X_BN_MODE</code>	In the setter the <code>*param</code> should be a pointer to a previously initialized <code>cudaBatchNormMode_t</code> .	Describes the mode of operation for the scale, bias and the statistics.	<code>CUDNN_BATCHNORM_PER_ACTIVATION</code>

For the attribute CUDNN_FUSED_SCALE_BIAS_ACTIVATION_WGRAD in cudnnFusedOp_t:			
Attribute	Expected Descriptor Type Passed in, in the Setter	Description	Default Value After Creation
		As of cuDNN 7.6.0, only “CUDNN_BATCHNORM_SPATIAL” and “CUDNN_BATCHNORM_SPATIAL_PERSISTENT” are supported, i.e., scale, bias and statistics are all per-channel.	
X_BN_EQSCALEBIAS_DESC	In the setter the <code>*param</code> should be a pointer to a previously initialized <code>cudnnTensorDescriptor_t</code> .	Tensor descriptor describing the size, layout and datatype of the batchNorm equivalent scale and bias tensors. The shapes must match the mode specified in “CUDNN_PARAM_BN_MODE”. If set to NULL, both scale and bias operation will become a NOP.	NULL
X_BN_EQSCALE_PLACEHOLDER	In the setter the <code>*param</code> should be a pointer to a previously initialized <code>X_PointerPlaceHolder_t</code> .	Describes whether batchnorm equivalent scale pointer in the VariantParamPack will be NULL, or if not, user promised pointer alignment *.  If set to CUDNN_PTR_NULL, then the scale operation becomes a NOP.	CUDNN_PTR_NULL
X_BN_EQBIAS_PLACEHOLDER	In the setter the <code>*param</code> should be a pointer to a previously initialized <code>X_PointerPlaceHolder_t</code> .	Describes whether batchnorm equivalent bias pointer in the VariantParamPack will be NULL, or if not, user promised pointer alignment *.  If set to CUDNN_PTR_NULL, then the bias operation becomes a NOP.	CUDNN_PTR_NULL
X_ACTIVATION_DESC	In the setter the <code>*param</code> should be a pointer to a	Describes the activation operation.	NULL

For the attribute CUDNN_FUSED_SCALE_BIAS_ACTIVATION_WGRAD in cudnnFusedOp_t:			
Attribute	Expected Descriptor Type Passed in, in the Setter	Description	Default Value After Creation
	previously initialized <code>cudnnActivationDescriptor_t*</code>	As of 7.6.0, only activation mode of “CUDNN_ACTIVATION_RELU” and “CUDNN_ACTIVATION_IDENTITY” is supported. If set to NULL or if the activation mode is set to “CUDNN_ACTIVATION_IDENTITY”, then the activation in the op sequence becomes a NOP.	
X_CONV_DESC	In the setter the <code>*param</code> should be a pointer to a previously initialized <code>cudnnConvolutionDescriptor_t*</code> .	Describes the convolution operation.	NULL
X_DWDESC	In the setter the <code>*param</code> should be a pointer to a previously initialized <code>cudnnFilterDescriptor_t*</code> .	Filter descriptor describing the size, layout and datatype of the <code>dw</code> (filter gradient output) tensor.	NULL
X_DWDATA_PLACEHOLDER	In the setter the <code>*param</code> should be a pointer to a previously initialized <code>X_PointerPlaceholder_t*</code> .	Describes whether <code>dw</code> (filter gradient output) tensor pointer in the <code>VariantParamPack</code> will be NULL, or if not, user promised pointer alignment *.	CUDNN_PTR_NULL
X_DYDESC	In the setter the <code>*param</code> should be a pointer to a previously initialized <code>cudnnTensorDescriptor_t*</code> .	Tensor descriptor describing the size, layout and datatype of the <code>dy</code> (gradient input) tensor.	NULL
X_DYDATA_PLACEHOLDER	In the setter the <code>*param</code> should be a pointer to a previously initialized <code>X_PointerPlaceholder_t*</code> .	Describes whether <code>dy</code> (gradient input) tensor pointer in the <code>VariantParamPack</code> will be NULL, or if not,	CUDNN_PTR_NULL

For the attribute CUDNN_FUSED_SCALE_BIAS_ACTIVATION_WGRAD in cudnnFusedOp_t:			
Attribute	Expected Descriptor Type Passed in, in the Setter	Description	Default Value After Creation
		user promised pointer alignment *.	



If the corresponding pointer placeholder in ConstParamPack is set to “CUDNN\_PTR\_NULL”, then the device pointer in the VariantParamPack need to be NULL as well.



If the corresponding pointer placeholder in ConstParamPack is set to “CUDNN\_PTR\_ELEM\_ALIGNED” or “CUDNN\_PTR\_16B\_ALIGNED”, then the device pointer in the VariantParamPack may not be NULL and need to be at least element-aligned or 16 bytes-aligned, respectively.

As of cuDNN 7.6.0, if the conditions in the [Table 6](#) are met, then the fully fused fast path will be triggered. Otherwise a slower partially fused path will be triggered.

**Table 6 Conditions for Fully Fused Fast Path (Backward)**

Parameter	Condition
Device compute capability	Need to be one of 7.0, 7.2 or 7.5
CUDNN_PARAM_XDESC CUDNN_PARAM_XDATA_PLACEHOLDER	Tensor is 4 dimensional Datatype is CUDNN_DATA_HALF Layout is NHWC fully packed Alignment is CUDNN_PTR_16B_ALIGNED Tensor’s C dimension is a multiple of 8.
CUDNN_PARAM_BN_EQSCALEBIAS_DESC CUDNN_PARAM_BN_EQSCALE_PLACEHOLDER CUDNN_PARAM_BN_EQBIAS_PLACEHOLDER	If either one of scale and bias operation is not turned into a NOP: Tensor is 4 dimensional with shape 1xCx1x1 Datatype is CUDNN_DATA_HALF Layout is fully packed Alignment is CUDNN_PTR_16B_ALIGNED
CUDNN_PARAM_CONV_DESC CUDNN_PARAM_DWDESC CUDNN_PARAM_DWDATA_PLACEHOLDER	Convolution descriptor’s mode need to be CUDNN_CROSS_CORRELATION Convolution descriptor’s dataType need to be CUDNN_DATA_FLOAT Convolution descriptor’s dilationA is (1,1) Convolution descriptor’s group count need to be 1 Convolution descriptor’s mathType need to be CUDNN_TENSOR_OP_MATH or CUDNN_TENSOR_OP_MATH_ALLOW_CONVERSION

Parameter	Condition
	Filter gradient is in NHWC layout Filter gradient's data type is CUDNN_DATA_HALF Filter gradient's K dimension is a multiple of 32. Filter gradient size RxS is either 1x1 or 3x3 If filter gradient size RxS is 1x1, convolution descriptor's padA need to be (0,0) and filterStrideA need to be (1,1) Filter gradient's alignment is CUDNN_PTR_16B_ALIGNED
CUDNN_PARAM_DYDESC CUDNN_PARAM_DYDATA_PLACEHOLDER	Tensor is 4 dimensional Datatype is CUDNN_DATA_HALF Layout is NHWC fully packed Alignment is CUDNN_PTR_16B_ALIGNED

Table 7 CUDNN\_FUSED\_BN\_FINALIZE\_STATISTICS\_TRAINING

For the attribute CUDNN_FUSED_BN_FINALIZE_STATISTICS_TRAINING in cudnnFusedOp_t:			
Attribute	Expected Descriptor Type Passed in, in the Setter	Description	Default Value After Creation
X_BN_MODE	In the setter the <code>*param</code> should be a pointer to a previously initialized <code>cudnnBatchNormMode_t*</code> .	Describes the mode of operation for the scale, bias and the statistics. As of cuDNN 7.6.0, only "CUDNN_BATCHNORM_SPATIAL" and "CUDNN_BATCHNORM_SPATIAL_PERSISTENT" are supported, i.e., scale, bias and statistics are all per-channel.	CUDNN_BATCHNORM_PER_ACTIVATION
X_YSTATS_DESC	In the setter the <code>*param</code> should be a pointer to a previously initialized <code>cudnnTensorDescriptor_t*</code> .	Tensor descriptor describing the size, layout and datatype of the sum of <code>y</code> and sum of <code>y</code> square tensors. The shapes need to match the mode specified in "CUDNN_PARAM_BN_MODE".	NULL
X_YSUM_PLACEHOLDER	In the setter the <code>*param</code> should be a pointer to a	Describes whether sum of <code>y</code> pointer in the VariantParamPack will be NULL, or if not,	CUDNN_PTR_NULL

For the attribute CUDNN_FUSED_BN_FINALIZE_STATISTICS_TRAINING in cudnnFusedOp_t:			
Attribute	Expected Descriptor Type Passed in, in the Setter	Description	Default Value After Creation
	previously initialized X_PointerPlaceholder_t	user promised pointer *alignment *.	
X_YSQSUM_PLACEHOLDER	In the setter the *param should be a pointer to a previously initialized X_PointerPlaceholder_t	Describes whether sum of $y$ square pointer in the VariantParamPack will be NULL, or if not, user promised pointer *alignment *.	CUDNN_PTR_NULL
X_BN_SCALEBIAS_MEANVAR_DESC	In the setter the *param should be a pointer to a previously initialized cudnnTensorDescriptor_t	A common tensor descriptor describing the size, layout and datatype of the batchNorm trained scale, bias and statistics tensors. The shapes need to match the mode specified in “CUDNN_PARAM_BN_MODE” (similar to the bnScaleBiasMeanVarDesc field in the cudnnBatchNormalization* API).	NULL
X_BN_SCALE_PLACEHOLDER	In the setter the *param should be a pointer to a previously initialized X_PointerPlaceholder_t	Describes whether the batchNorm trained scale pointer in the VariantParamPack will be NULL, or if not, user promised pointer *alignment *.  If the output of “BN_EQSCALE” is not needed, this is not needed and may be NULL.	CUDNN_PTR_NULL
X_BN_BIAS_PLACEHOLDER	In the setter the *param should be a pointer to a previously initialized X_PointerPlaceholder_t	Describes whether the batchNorm trained bias pointer in the VariantParamPack will be NULL, or if not, user promised pointer *alignment *.  If neither output of “BN_EQSCALE” or “BN_EQBIAS” is needed, this is not needed and may be NULL.	CUDNN_PTR_NULL

For the attribute CUDNN_FUSED_BN_FINALIZE_STATISTICS_TRAINING in cudnnFusedOp_t:			
Attribute	Expected Descriptor Type Passed in, in the Setter	Description	Default Value After Creation
X_BN_SAVED_MEAN_PLACEHOLDER	In the setter the <code>*param</code> should be a pointer to a previously initialized <code>X_PointerPlaceholder_t</code> .	Describes whether the batchNorm saved mean pointer in the VariantParamPack will be NULL, or if not, user promised pointer alignment *.  If set to CUDNN_PTR_NULL, then the computation for this output becomes a NOP.	CUDNN_PTR_NULL
X_BN_SAVED_INVSTD_PLACEHOLDER	In the setter the <code>*param</code> should be a pointer to a previously initialized <code>X_PointerPlaceholder_t</code> .	Describes whether the batchNorm saved inverse standard deviation pointer in the VariantParamPack will be NULL, or if not, user promised pointer alignment *.  If set to CUDNN_PTR_NULL, then the computation for this output becomes a NOP.	CUDNN_PTR_NULL
X_BN_RUNNING_MEAN_PLACEHOLDER	In the setter the <code>*param</code> should be a pointer to a previously initialized <code>X_PointerPlaceholder_t</code> .	Describes whether the batchNorm running mean pointer in the VariantParamPack will be NULL, or if not, user promised pointer alignment *.  If set to CUDNN_PTR_NULL, then the computation for this output becomes a NOP.	CUDNN_PTR_NULL
X_BN_RUNNING_VAR_PLACEHOLDER	In the setter the <code>*param</code> should be a pointer to a previously initialized <code>X_PointerPlaceholder_t</code> .	Describes whether the batchNorm running variance pointer in the VariantParamPack will be NULL, or if not, user promised pointer alignment *.  If set to CUDNN_PTR_NULL, then the computation	CUDNN_PTR_NULL

For the attribute CUDNN_FUSED_BN_FINALIZE_STATISTICS_TRAINING in cudnnFusedOp_t:			
Attribute	Expected Descriptor Type Passed in, in the Setter	Description	Default Value After Creation
		for this output becomes a NOP.	
X_BN_EQSCALEBIAS_DESC	In the setter the <code>*param</code> should be a pointer to a previously initialized <code>cudnnTensorDescriptor_t</code> .	Tensor descriptor describing the size, layout and datatype of the batchNorm equivalent scale and bias tensors. The shapes need to match the mode specified in "CUDNN_PARAM_BN_MODE".  If neither output of "BN_EQSCALE" or "BN_EQBIAS" is needed, this is not needed and may be NULL.	NULL
X_BN_EQSCALE_PLACEHOLDER	In the setter the <code>*param</code> should be a pointer to a previously initialized <code>X_PointerPlaceholder_t</code> .	Describes whether batchnorm equivalent scale pointer in the <code>VariantParamPack</code> will be NULL, or if not, user promised pointer alignment *.  If set to <code>CUDNN_PTR_NULL</code> , then the computation for this output becomes a NOP.	CUDNN_PTR_NULL
X_BN_EQBIAS_PLACEHOLDER	In the setter the <code>*param</code> should be a pointer to a previously initialized <code>X_PointerPlaceholder_t</code> .	Describes whether batchnorm equivalent bias pointer in the <code>VariantParamPack</code> will be NULL, or if not, user promised pointer alignment *.  If set to <code>CUDNN_PTR_NULL</code> , then the computation for this output becomes a NOP.	CUDNN_PTR_NULL



Table 8 CUDNN\_FUSED\_BN\_FINALIZE\_STATISTICS\_INFERENCE

For the attribute CUDNN_FUSED_BN_FINALIZE_STATISTICS_INFERENCE in cudnnFusedOp_t:			
Attribute	Expected Descriptor Type Passed in, in the Setter	Description	Default Value After Creation
X_BN_MODE	In the setter the <code>*param</code> should be a pointer to a previously initialized <code>cudnnBatchNormMode_t*</code> .	Describes the mode of operation for the scale, bias and the statistics. As of cuDNN 7.6.0, only “CUDNN_BATCHNORM_SPATIAL” and “CUDNN_BATCHNORM_SPATIAL_PERSISTENT” are supported, i.e., scale, bias and statistics are all per-channel.	CUDNN_BATCHNORM_PER_ACTIVATION
X_BN_SCALEBIAS_MEANVAR_DESCRIPTOR	In the setter the <code>*param</code> should be a pointer to a previously initialized <code>cudnnTensorDescriptor_t*</code> .	A common tensor descriptor describing the size, layout and datatype of the batchNorm trained scale, bias and statistics tensors. The shapes need to match the mode specified in “CUDNN_PARAM_BN_MODE” (similar to the <code>bnScaleBiasMeanVarDesc</code> field in the <code>cudnnBatchNormalization*</code> API).	NULL
X_BN_SCALE_PLACEHOLDER	In the setter the <code>*param</code> should be a pointer to a previously initialized <code>X_PointerPlaceholder_t*</code> .	Describes whether the batchNorm trained scale pointer in the <code>VariantParamPack</code> will be NULL, or if not, user promised pointer alignment *.	CUDNN_PTR_NULL
X_BN_BIAS_PLACEHOLDER	In the setter the <code>*param</code> should be a pointer to a previously initialized <code>X_PointerPlaceholder_t*</code> .	Describes whether the batchNorm trained bias pointer in the <code>VariantParamPack</code> will be NULL, or if not, user promised pointer alignment *.	CUDNN_PTR_NULL
X_BN_RUNNING_MEAN_PLACEHOLDER	In the setter the <code>*param</code> should be a pointer to a	Describes whether the batchNorm running mean pointer in the <code>VariantParamPack</code> will	CUDNN_PTR_NULL

For the attribute CUDNN_FUSED_BN_FINALIZE_STATISTICS_INFERENCE in cudnnFusedOp_t:			
Attribute	Expected Descriptor Type Passed in, in the Setter	Description	Default Value After Creation
	previously initialized X_PointerPlaceholder_t	be NULL, or if not, *user promised pointer alignment *.	
X_BN_RUNNING_VAR_PLACEHOLDER	In the setter the *param should be a pointer to a previously initialized X_PointerPlaceholder_t	Describes whether the batchNorm running variance pointer in the VariantParamPack will be NULL, or if not, user promised pointer alignment *.	CUDNN_PTR_NULL
X_BN_EQSCALEBIAS_DESC	In the setter the *param should be a pointer to a previously initialized cudnnTensorDescriptor_t	Tensor descriptor describing the size, layout and datatype of the batchNorm equivalent scale and bias tensors. The shapes need to match the mode specified in "CUDNN_PARAM_BN_MODE".	NULL
X_BN_EQSCALE_PLACEHOLDER	In the setter the *param should be a pointer to a previously initialized X_PointerPlaceholder_t	Describes whether batchnorm equivalent scale pointer in the VariantParamPack will be NULL, or if not, user promised pointer alignment *.  If set to CUDNN_PTR_NULL, then the computation for this output becomes a NOP.	CUDNN_PTR_NULL
X_BN_EQBIAS_PLACEHOLDER	In the setter the *param should be a pointer to a previously initialized X_PointerPlaceholder_t	Describes whether batchnorm equivalent bias pointer in the VariantParamPack will be NULL, or if not, user promised pointer alignment *.  If set to CUDNN_PTR_NULL, then the computation for this output becomes a NOP.	CUDNN_PTR_NULL

### 3.30. cudnnFusedOpsConstParamPack\_t

**cudaFusedOpsConstParamPack\_t** is a pointer to an opaque structure holding the description of the `cudaFusedOps` constant parameters. Use the function `cudaCreateFusedOpsConstParamPack` to create one instance of this structure, and the function `cudaDestroyFusedOpsConstParamPack` to destroy a previously-created descriptor.

### 3.31. cudaFusedOpsPlan\_t

**cudaFusedOpsPlan\_t** is a pointer to an opaque structure holding the description of the `cudaFusedOpsPlan`. This descriptor contains the plan information, including the problem type and size, which kernels should be run, and the internal workspace partition. Use the function `cudaCreateFusedOpsPlan` to create one instance of this structure, and the function `cudaDestroyFusedOpsPlan` to destroy a previously-created descriptor.

### 3.32. cudaFusedOpsPointerPlaceholder\_t

`cudaFusedOpsPointerPlaceholder_t` is an enumerated type used to select the alignment type of the `cudaFusedOps` descriptor pointer.

Member	Description
CUDNN_PTR_NULL = 0	Indicates that the pointer to the Tensor in the <code>variantPack</code> will be NULL.
CUDNN_PTR_ELEM_ALIGNED = 1	Indicates that the pointer to the Tensor in the <code>variantPack</code> will not be NULL, and will have element alignment.
CUDNN_PTR_16B_ALIGNED = 2	Indicates that the pointer to the Tensor in the <code>variantPack</code> will not be NULL, and will have 16 byte alignment.

### 3.33. cudaFusedOpsVariantParamLabel\_t

The `cudaFusedOpsVariantParamLabel_t` is an enumerated type that is used to set the buffer pointers. These buffer pointers can be changed in each iteration.

```
typedef enum {
    CUDNN_PTR_XDATA           = 0,
    CUDNN_PTR_BN_EQSCALE     = 1,
    CUDNN_PTR_BN_EQBIAS      = 2,
    CUDNN_PTR_WDATA          = 3,
    CUDNN_PTR_DWDATA         = 4,
    CUDNN_PTR_YDATA          = 5,
    CUDNN_PTR_DYDATA         = 6,
    CUDNN_PTR_YSUM           = 7,
    CUDNN_PTR_YSQSUM         = 8,
    CUDNN_PTR_WORKSPACE      = 9,
    CUDNN_PTR_BN_SCALE       = 10,
    CUDNN_PTR_BN_BIAS        = 11,
    CUDNN_PTR_BN_SAVED_MEAN  = 12,
```

```

CUDNN_PTR_BN_SAVED_INVSTD           = 13,
CUDNN_PTR_BN_RUNNING_MEAN          = 14,
CUDNN_PTR_BN_RUNNING_VAR           = 15,
CUDNN_PTR_ZDATA                     = 16,
CUDNN_PTR_BN_Z_EQSCALE              = 17,
CUDNN_PTR_BN_Z_EQBIAS               = 18,
CUDNN_PTR_ACTIVATION_BITMASK        = 19,
CUDNN_PTR_DXDATA                    = 20,
CUDNN_PTR_DZDATA                    = 21,
CUDNN_PTR_BN_DSCALE                  = 22,
CUDNN_PTR_BN_DBIAS                  = 23,
CUDNN_SCALAR_SIZE_T_WORKSPACE_SIZE_IN_BYTES = 100,
CUDNN_SCALAR_INT64_T_BN_ACCUMULATION_COUNT = 101,
CUDNN_SCALAR_DOUBLE_BN_EXP_AVG_FACTOR = 102,
CUDNN_SCALAR_DOUBLE_BN_EPSILON      = 103,
} cudnnFusedOpsVariantParamLabel_t;

```

Table 9 Legend For Tables in This Section

Short-form used:	Stands for:
Setter	<a href="#">cudnnSetFusedOpsVariantParamPackAttribute</a>
Getter	<a href="#">cudnnGetFusedOpsVariantParamPackAttribute</a>
"X_" prefix in the Attribute column	Stands for "CUDNN_PTR_" or "CUDNN_SCALAR_" in the enumerator name

Table 10 CUDNN\_FUSED\_SCALE\_BIAS\_ACTIVATION\_CONV\_BNSTATS

For the attribute CUDNN_FUSED_SCALE_BIAS_ACTIVATION_CONV_BNSTATS in cudnnFusedOp_t:				
Attribute key	Expected Descriptor Type Passed in, in the Setter	I/O Type	Description	Default Value
X_XDATA	void *	input	Pointer to x (input) Tensor on device, need to agree with previously set CUDNN_PARAM_XDATA_PLACEHOLDER attribute *.	NULL
X_BN_EQSCALE	void *	input	Pointer to batchnorm equivalent scale tensor on device, need to agree with previously set CUDNN_PARAM_BN_EQSCALE_PLACEHOLDER attribute *.	NULL
X_BN_EQBIAS	void *	input	Pointer to batchnorm equivalent bias tensor on device, need to agree with previously set CUDNN_PARAM_BN_EQBIAS_PLACEHOLDER attribute *	NULL
X_WDATA	void *	input	Pointer to w (filter) tensor on device, need to agree with previously set	NULL

For the attribute CUDNN_FUSED_SCALE_BIAS_ACTIVATION_CONV_BNSTATS in cudnnFusedOp_t:				
Attribute key	Expected Descriptor Type Passed in, in the Setter	I/O Type	Description	Default Value
			CUDNN_PARAM_WDATA_PLACEHOLDER attribute *	
X_YDATA	void *	output	Pointer to y (output) tensor on device, need to agree with previously set CUDNN_PARAM_YDATA_PLACEHOLDER attribute *	NULL
X_YSUM	void *	output	Pointer to sum of y tensor on device, need to agree with previously set CUDNN_PARAM_YSUM_PLACEHOLDER attribute *	NULL
X_YSQSUM	void *	output	Pointer to sum of y square tensor on device, need to agree with previously set CUDNN_PARAM_YSQSUM_PLACEHOLDER attribute *	NULL
X_WORKSPACE	void *	input	Pointer to user allocated workspace on device. Can be NULL if the workspace size requested is 0.	NULL
X_SIZE_T_WORKSPACE_SIZE	size_t	input	Pointer to a size_t value in host memory describing the user allocated workspace size in bytes. The amount need to be equal or larger than the amount requested in cudnnMakeFusedOpsPlan	0



If the corresponding pointer placeholder in ConstParamPack is set to “CUDNN\_PTR\_NULL”, then the device pointer in the VariantParamPack need to be NULL as well.



If the corresponding pointer placeholder in ConstParamPack is set to “CUDNN\_PTR\_ELEM\_ALIGNED” or “CUDNN\_PTR\_16B\_ALIGNED”, then the device pointer in the VariantParamPack may not be NULL and need to be at least element-aligned or 16 bytes-aligned, respectively.

Table 11 CUDNN\_FUSED\_SCALE\_BIAS\_ACTIVATION\_WGRAD

For the attribute CUDNN_FUSED_SCALE_BIAS_ACTIVATION_WGRAD in cudnnFusedOp_t:				
Attribute key	Expected Descriptor Type Passed in, in the Setter	I/O Type	Description	Default Value
X_XDATA	void *	input	Pointer to x (input) tensor on device, need to agree with previously set CUDNN_PARAM_XDATA_PLACEHOLDER attribute *	NULL
X_BN_EQSCALE	void *	input	Pointer to batchnorm equivalent scale tensor on device, need to agree with previously set CUDNN_PARAM_BN_EQSCALE_PLACEHOLDER attribute *	NULL
X_BN_EQBIAS	void *	input	Pointer to batchnorm equivalent bias tensor on device, need to agree with previously set CUDNN_PARAM_BN_EQBIAS_PLACEHOLDER attribute *	NULL
X_DWDATA	void *	output	Pointer to dw (filter gradient output) tensor on device, need to agree with previously set CUDNN_PARAM_WDATA_PLACEHOLDER attribute *	NULL
X_DYDATA	void *	input	Pointer to dy (gradient input) tensor on device, need to agree with previously set CUDNN_PARAM_YDATA_PLACEHOLDER attribute *	NULL
X_WORKSPACE	void *	input	Pointer to user allocated workspace on device. Can be NULL if the workspace size requested is 0.	NULL
X_SIZE_T_WORKSPACE_SIZE_IN_BYTES	size_t *	input	Pointer to a size_t value in host memory describing the user allocated workspace size in bytes. The amount need to be equal or larger	0

For the attribute CUDNN_FUSED_SCALE_BIAS_ACTIVATION_WGRAD in cudnnFusedOp_t:				
Attribute key	Expected Descriptor Type Passed in, in the Setter	I/O Type	Description	Default Value
			than the amount requested in <code>cudnnMakeFusedOpsPlan</code>	



If the corresponding pointer placeholder in `ConstParamPack` is set to “CUDNN\_PTR\_NULL”, then the device pointer in the `VariantParamPack` need to be NULL as well.



If the corresponding pointer placeholder in `ConstParamPack` is set to “CUDNN\_PTR\_ELEM\_ALIGNED” or “CUDNN\_PTR\_16B\_ALIGNED”, then the device pointer in the `VariantParamPack` may not be NULL and need to be at least element-aligned or 16 bytes-aligned, respectively.

Table 12 CUDNN\_FUSED\_BN\_FINALIZE\_STATISTICS\_TRAINING

For the attribute CUDNN_FUSED_BN_FINALIZE_STATISTICS_TRAINING in cudnnFusedOp_t:				
Attribute key	Expected Descriptor Type Passed in, in the Setter	I/O Type	Description	Default Value
X_YSUM	void *	input	Pointer to sum of y tensor on device, need to agree with previously set CUDNN_PARAM_YSUM_PLACEHOLDER attribute *	NULL
X_YSQSUM	void *	input	Pointer to sum of y square tensor on device, need to agree with previously set CUDNN_PARAM_YSQSUM_PLACEHOLDER attribute *	NULL
X_BN_SCALE	void *	input	Pointer to sum of y square tensor on device, need to agree with previously set CUDNN_PARAM_BN_SCALE_PLACEHOLDER attribute *	NULL
X_BN_BIAS	void *	input	Pointer to sum of y square tensor on device, need to agree with previously set	NULL

For the attribute CUDNN_FUSED_BN_FINALIZE_STATISTICS_TRAINING in cudnnFusedOp_t:				
Attribute key	Expected Descripto Type Passed in, in the Setter	I/O Type	Description	Default Value
			CUDNN_PARAM_BN_BIAS_PLACEHOLDER attribute *	
X_BN_SAVED_MEAN	void *	output	Pointer to sum of y square tensor on device, need to agree with previously set CUDNN_PARAM_BN_SAVED_MEAN_PLACEHOLDER attribute *	NULL
X_BN_SAVED_INVSTD	void *	output	Pointer to sum of y square tensor on device, need to agree with previously set CUDNN_PARAM_BN_SAVED_INVSTD_PLACEHOLDER attribute *	NULL
X_BN_RUNNING_MEAN	void *	input/output	Pointer to sum of y square tensor on device, need to agree with previously set CUDNN_PARAM_BN_RUNNING_MEAN_PLACEHOLDER attribute *	NULL
X_BN_RUNNING_VAR	void *	input/output	Pointer to sum of y square tensor on device, need to agree with previously set CUDNN_PARAM_BN_RUNNING_VAR_PLACEHOLDER attribute *	NULL
X_BN_EQSCALE	void *	output	Pointer to batchnorm equivalent scale tensor on device, need to agree with previously set CUDNN_PARAM_BN_EQSCALE_PLACEHOLDER attribute *	NULL
X_BN_EQBIAS	void *	output	Pointer to batchnorm equivalent bias tensor on device, need to agree with previously set CUDNN_PARAM_BN_EQBIAS_PLACEHOLDER attribute *	NULL
X_INT64_T_BN_ACCUMULATION_COUNT	uint64_t *	input	<p>Pointer to a scalar value in int64_t on host memory.</p> <p>This value should describe the number of tensor elements accumulated in the sum of y and sum of y square tensors.</p> <p>For example:</p> <p>In the single GPU use case, and if the mode is CUDNN_BATCHNORM_SPATIAL or CUDNN_BATCHNORM_SPATIAL_PERSISTENT,</p>	0



For the attribute CUDNN_FUSED_BN_FINALIZE_STATISTICS_TRAINING in cudnnFusedOp_t:				
Attribute key	Expected Descriptor Type Passed in, in the Setter	I/O Type	Description	Default Value
			<p>the value should be equal to <math>N \times H \times W</math> of the tensor from which the statistics are calculated.</p> <p>In multi-GPU use case, if all-reduce has been performed on the sum of y and sum of y square tensors, this value should be the sum of the single GPU accumulation count on each of the GPUs.</p>	
X_DOUBLE_BN_EXP_AVG_FACTOR	double *	input	<p>Pointer to a scalar value in double on host memory.</p> <p>Factor used in the moving average computation. See “exponentialAverageFactor” in cudnnBatchNormalization* APIs</p>	0.0
X_DOUBLE_BN_EPSILON	double *	input	<p>Pointer to a scalar value in double on host memory.</p> <p>A conditioning constant used in the batch normalization formula. Its value should be equal to or greater than the value defined for CUDNN_BN_MIN_EPSILON in cudnn.h</p> <p>See “exponentialAverageFactor” in cudnnBatchNormalization* APIs</p>	0.0
X_WORKSPACE	void *	input	<p>Pointer to user allocated workspace on device. Can be NULL if the workspace size requested is 0.</p>	NULL
X_SIZE_T_WORKSPACE_SIZE_IN_BYTES	size_t *	input	<p>Pointer to a size_t value in host memory describing the user allocated workspace size in bytes. The amount need to be equal or larger</p>	0

For the attribute CUDNN_FUSED_BN_FINALIZE_STATISTICS_TRAINING in cudnnFusedOp_t:				
Attribute key	Expected Descriptor Type Passed in, in the Setter	I/O Type	Description	Default Value
			than the amount requested in <code>cudnnMakeFusedOpsPlan</code> .	



If the corresponding pointer placeholder in `ConstParamPack` is set to “CUDNN\_PTR\_NULL”, then the device pointer in the `VariantParamPack` need to be NULL as well.



If the corresponding pointer placeholder in `ConstParamPack` is set to “CUDNN\_PTR\_ELEM\_ALIGNED” or “CUDNN\_PTR\_16B\_ALIGNED”, then the device pointer in the `VariantParamPack` may not be NULL and need to be at least element-aligned or 16 bytes-aligned, respectively.

Table 13 CUDNN\_FUSED\_BN\_FINALIZE\_STATISTICS\_INFERENCE

For the attribute CUDNN_FUSED_BN_FINALIZE_STATISTICS_INFERENCE in cudnnFusedOp_t:				
Attribute key	Expected Descriptor Type Passed in, in the Setter	I/O Type	Description	Default Value
X_BN_SCALE	void *	input	Pointer to sum of y square tensor on device, need to agree with previously set CUDNN_PARAM_BN_SCALE_PLACEHOLDER attribute *	NULL
X_BN_BIAS	void *	input	Pointer to sum of y square tensor on device, need to agree with previously set CUDNN_PARAM_BN_BIAS_PLACEHOLDER attribute *	NULL
X_BN_RUNNING_MEAN	void *	input/output	Pointer to sum of y square tensor on device, need to agree with previously set CUDNN_PARAM_BN_RUNNING_MEAN_PLACEHOLDER attribute *	NULL
X_BN_RUNNING_VAR	void *	input/output	Pointer to sum of y square tensor on device, need to	NULL

For the attribute CUDNN_FUSED_BN_FINALIZE_STATISTICS_INFERENCE in cudnnFusedOp_t:				
Attribute key	Expected Descripto Type Passed in, in the Setter	I/O Type	Description	Default Value
			agree with previously set CUDNN_PARAM_BN_RUNNING_VAR attribute *	PLACEHOLDER
X_BN_EQSCALE	void *	output	Pointer to batchnorm equivalent scale tensor on device, need to agree with previously set CUDNN_PARAM_BN_EQSCALE_PLACEHOLDER attribute *	NULL
X_BN_EQBIAS	void *	output	Pointer to batchnorm equivalent bias tensor on device, need to agree with previously set CUDNN_PARAM_BN_EQBIAS_PLACEHOLDER attribute *	NULL
X_DOUBLE_BN_EPSILON	double *	input	Pointer to a scalar value in double on host memory.  A conditioning constant used in the batch normalization formula. Its value should be equal to or greater than the value defined for CUDNN_BN_MIN_EPSILON in cudnn.h  See “exponentialAverageFactor” in cudnnBatchNormalization* APIs	0.0
X_WORKSPACE	void *	input	Pointer to user allocated workspace on device. Can be NULL if the workspace size requested is 0.	NULL
X_SIZE_T_WORKSPACE_SIZE_IN_BYTES	size_t *	input	Pointer to a size_t value in host memory describing the user allocated workspace size in bytes. The amount need to be equal or larger than the amount requested in cudnnMakeFusedOpsPlan.	0



If the corresponding pointer placeholder in ConstParamPack is set to “CUDNN\_PTR\_NULL”, then the device pointer in the VariantParamPack need to be NULL as well.



If the corresponding pointer placeholder in ConstParamPack is set to “CUDNN\_PTR\_ELEM\_ALIGNED” or “CUDNN\_PTR\_16B\_ALIGNED”, then the device

pointer in the `VariantParamPack` may not be NULL and need to be at least element-aligned or 16 bytes-aligned, respectively.

### 3.34. `cudaFusedOpsVariantParamPack_t`

`cudaFusedOpsVariantParamPack_t` is a pointer to an opaque structure holding the description of the `cudaFusedOps` variant parameters. Use the function `cudaCreateFusedOpsVariantParamPack` to create one instance of this structure, and the function `cudaDestroyFusedOpsVariantParamPack` to destroy a previously-created descriptor.

### 3.35. `cudaHandle_t`

`cudaHandle_t` is a pointer to an opaque structure holding the cuDNN library context. The cuDNN library context must be created using `cudaCreate` () and the returned handle must be passed to all subsequent library function calls. The context should be destroyed at the end using `cudaDestroy` (). The context is associated with only one GPU device, the current device at the time of the call to `cudaCreate` (). However multiple contexts can be created on the same GPU device.

### 3.36. `cudaIndicesType_t`

`cudaIndicesType_t` is an enumerated type used to indicate the data type for the indices to be computed by the `cudaReduceTensor` () routine. This enumerated type is used as a field for the `cudaReduceTensorDescriptor_t` descriptor.

#### Values

`CUDA_32BIT_INDICES`

Compute unsigned int indices

`CUDA_64BIT_INDICES`

Compute unsigned long long indices

`CUDA_16BIT_INDICES`

Compute unsigned short indices

`CUDA_8BIT_INDICES`

Compute unsigned char indices

### 3.37. `cudaLossNormalizationMode_t`

`cudaLossNormalizationMode_t` is an enumerated type that controls the input normalization mode for a loss function. This type can be used with `cudaSetCTCLossDescriptorEx`.

#### Values

##### `CUDNN_LOSS_NORMALIZATION_NONE`

The input `probs` of `cudaCTCLoss` function is expected to be the normalized probability, and the output `gradients` is the gradient of loss with respect to the unnormalized probability.

##### `CUDNN_LOSS_NORMALIZATION_SOFTMAX`

The input `probs` of `cudaCTCLoss` function is expected to be the unnormalized activation from the previous layer, and the output `gradients` is the gradient with respect to the activation. Internally the probability is computed by softmax normalization.

## 3.38. `cudaLRNMode_t`

`cudaLRNMode_t` is an enumerated type used to specify the mode of operation in `cudaLRNCrossChannelForward()` and `cudaLRNCrossChannelBackward()`.

#### Values

##### `CUDNN_LRN_CROSS_CHANNEL_DIM1`

LRN computation is performed across tensor's dimension `dimA[1]`.

## 3.39. `cudaMathType_t`

`cudaMathType_t` is an enumerated type used to indicate if the use of Tensor Core Operations is permitted a given library routine.

#### Values

##### `CUDNN_DEFAULT_MATH`

Tensor Core Operations are not used.

##### `CUDNN_TENSOR_OP_MATH`

The use of Tensor Core Operations is permitted.

##### `CUDNN_TENSOR_OP_MATH_ALLOW_CONVERSION`

Enables the use of FP32 tensors for both input and output.

## 3.40. `cudaMultiHeadAttnWeightKind_t`

`cudaMultiHeadAttnWeightKind_t` is an enumerated type to specify the multi-head weight group.

Member	Description
CUDNN_ATTN_Q_WEIGHTS = 0	Selects the multi-head query weight group.
CUDNN_ATTN_K_WEIGHTS = 1	Selects the multi-head key weight group.
CUDNN_ATTN_V_WEIGHTS = 2	Selects the multi-head value weight group.
CUDNN_ATTN_O_WEIGHTS = 3	Selects the multi-head output weight group.

## 3.41. cudnnNanPropagation\_t

**cudnnNanPropagation\_t** is an enumerated type used to indicate if a given routine should propagate **Nan** numbers. This enumerated type is used as a field for the **cudnnActivationDescriptor\_t** descriptor and **cudnnPoolingDescriptor\_t** descriptor.

### Values

**CUDNN\_NOT\_PROPAGATE\_NAN**

**Nan** numbers are not propagated

**CUDNN\_PROPAGATE\_NAN**

**Nan** numbers are propagated

## 3.42. cudnnOpTensorDescriptor\_t

**cudnnOpTensorDescriptor\_t** is a pointer to an opaque structure holding the description of a Tensor Core Operation, used as a parameter to **cudnnOpTensor()**. **cudnnCreateOpTensorDescriptor()** is used to create one instance, and **cudnnSetOpTensorDescriptor()** must be used to initialize this instance.

## 3.43. cudnnOpTensorOp\_t

**cudnnOpTensorOp\_t** is an enumerated type used to indicate the Tensor Core Operation to be used by the **cudnnOpTensor()** routine. This enumerated type is used as a field for the **cudnnOpTensorDescriptor\_t** descriptor.

### Values

**CUDNN\_OP\_TENSOR\_ADD**

The operation to be performed is addition

**CUDNN\_OP\_TENSOR\_MUL**

The operation to be performed is multiplication

**CUDNN\_OP\_TENSOR\_MIN**

The operation to be performed is a minimum comparison

**CUDNN\_OP\_TENSOR\_MAX**

The operation to be performed is a maximum comparison

**CUDNN\_OP\_TENSOR\_SQRT**

The operation to be performed is square root, performed on only the A tensor

**CUDNN\_OP\_TENSOR\_NOT**

The operation to be performed is negation, performed on only the A tensor

## 3.44. cudnnPersistentRNNPlan\_t

**cudnnPersistentRNNPlan\_t** is a pointer to an opaque structure holding a plan to execute a dynamic persistent RNN. **cudnnCreatePersistentRNNPlan()** is used to create and initialize one instance.

## 3.45. cudnnPoolingDescriptor\_t

**cudnnPoolingDescriptor\_t** is a pointer to an opaque structure holding the description of a pooling operation. **cudnnCreatePoolingDescriptor()** is used to create one instance, and **cudnnSetPoolingNdDescriptor()** or **cudnnSetPooling2dDescriptor()** must be used to initialize this instance.

## 3.46. cudnnPoolingMode\_t

**cudnnPoolingMode\_t** is an enumerated type passed to **cudnnSetPoolingDescriptor()** to select the pooling method to be used by **cudnnPoolingForward()** and **cudnnPoolingBackward()**.

### Values

**CUDNN\_POOLING\_MAX**

The maximum value inside the pooling window is used.

**CUDNN\_POOLING\_AVERAGE\_COUNT\_INCLUDE\_PADDING**

Values inside the pooling window are averaged. The number of elements used to calculate the average includes spatial locations falling in the padding region.

**CUDNN\_POOLING\_AVERAGE\_COUNT\_EXCLUDE\_PADDING**

Values inside the pooling window are averaged. The number of elements used to calculate the average excludes spatial locations falling in the padding region.

**CUDNN\_POOLING\_MAX\_DETERMINISTIC**

The maximum value inside the pooling window is used. The algorithm used is deterministic.

## 3.47. cudnnReduceTensorDescriptor\_t

**cudnnReduceTensorDescriptor\_t** is a pointer to an opaque structure holding the description of a tensor reduction operation, used as a parameter to **cudnnReduceTensor()**. **cudnnCreateReduceTensorDescriptor()** is used to create one instance, and **cudnnSetReduceTensorDescriptor()** must be used to initialize this instance.

## 3.48. cudnnReduceTensorIndices\_t

**cudnnReduceTensorIndices\_t** is an enumerated type used to indicate whether indices are to be computed by the **cudnnReduceTensor()** routine. This enumerated type is used as a field for the **cudnnReduceTensorDescriptor\_t** descriptor.

### Values

**CUDNN\_REDUCE\_TENSOR\_NO\_INDICES**

Do not compute indices

**CUDNN\_REDUCE\_TENSOR\_FLATTENED\_INDICES**

Compute indices. The resulting indices are relative, and flattened.

## 3.49. cudnnReduceTensorOp\_t

**cudnnReduceTensorOp\_t** is an enumerated type used to indicate the Tensor Core Operation to be used by the **cudnnReduceTensor()** routine. This enumerated type is used as a field for the **cudnnReduceTensorDescriptor\_t** descriptor.

### Values

**CUDNN\_REDUCE\_TENSOR\_ADD**

The operation to be performed is addition

**CUDNN\_REDUCE\_TENSOR\_MUL**

The operation to be performed is multiplication

**CUDNN\_REDUCE\_TENSOR\_MIN**

The operation to be performed is a minimum comparison

**CUDNN\_REDUCE\_TENSOR\_MAX**

The operation to be performed is a maximum comparison

**CUDNN\_REDUCE\_TENSOR\_AMAX**

The operation to be performed is a maximum comparison of absolute values



**CUDNN\_REDUCE\_TENSOR\_AVG**

The operation to be performed is averaging

**CUDNN\_REDUCE\_TENSOR\_NORM1**

The operation to be performed is addition of absolute values

**CUDNN\_REDUCE\_TENSOR\_NORM2**

The operation to be performed is a square root of sum of squares

**CUDNN\_REDUCE\_TENSOR\_MUL\_NO\_ZEROS**

The operation to be performed is multiplication, not including elements of value zero

## 3.50. cudnnReorderType\_t

```
typedef enum {
    CUDNN_DEFAULT_REORDER = 0,
    CUDNN_NO_REORDER      = 1,
} cudnnReorderType_t;
```

**cudnnReorderType\_t** is an enumerated type to set the convolution reordering type. The reordering type can be set by [cudnnSetConvolutionReorderType](#) and its status can be read by [cudnnGetConvolutionReorderType](#).

## 3.51. cudnnRNNAlgo\_t

**cudnnRNNAlgo\_t** is an enumerated type used to specify the algorithm used in the [cudnnRNNForwardInference\(\)](#), [cudnnRNNForwardTraining\(\)](#), [cudnnRNNBackwardData\(\)](#) and [cudnnRNNBackwardWeights\(\)](#) routines.

### Values

**CUDNN\_RNN\_ALGO\_STANDARD**

Each RNN layer is executed as a sequence of operations. This algorithm is expected to have robust performance across a wide range of network parameters.

**CUDNN\_RNN\_ALGO\_PERSIST\_STATIC**

The recurrent parts of the network are executed using a *persistent kernel* approach. This method is expected to be fast when the first dimension of the input tensor is small (ie. a small minibatch).

**CUDNN\_RNN\_ALGO\_PERSIST\_STATIC** is only supported on devices with compute capability  $\geq 6.0$ .

**CUDNN\_RNN\_ALGO\_PERSIST\_DYNAMIC**

The recurrent parts of the network are executed using a *persistent kernel* approach. This method is expected to be fast when the first dimension of the input tensor is small (ie. a small minibatch). When using **CUDNN\_RNN\_ALGO\_PERSIST\_DYNAMIC** persistent kernels are prepared at runtime and are able to optimized using the specific parameters of the network and active GPU. As such, when using **CUDNN\_RNN\_ALGO\_PERSIST\_DYNAMIC** a one-time plan preparation stage must be

executed. These plans can then be reused in repeated calls with the same model parameters.

The limits on the maximum number of hidden units supported when using `CUDNN_RNN_ALGO_PERSIST_DYNAMIC` are significantly higher than the limits when using `CUDNN_RNN_ALGO_PERSIST_STATIC`, however throughput is likely to significantly reduce when exceeding the maximums supported by `CUDNN_RNN_ALGO_PERSIST_STATIC`. In this regime this method will still outperform `CUDNN_RNN_ALGO_STANDARD` for some cases.

`CUDNN_RNN_ALGO_PERSIST_DYNAMIC` is only supported on devices with compute capability  $\geq 6.0$  on Linux machines.

## 3.52. cudnnRNNBiasMode\_t

`cudnnRNNBiasMode_t` is an enumerated type used to specify the number of bias vectors for RNN functions. See the description of the `cudnnRNNMode_t` enumerated type for the equations for each cell type based on the bias mode.

### Values

`CUDNN_RNN_NO_BIAS`

Applies RNN cell formulas that do not use biases.

`CUDNN_RNN_SINGLE_INP_BIAS`

Applies RNN cell formulas that use one input bias vector in the input GEMM.

`CUDNN_RNN_DOUBLE_BIAS`

Applies RNN cell formulas that use two bias vectors.

`CUDNN_RNN_SINGLE_REC_BIAS`

Applies RNN cell formulas that use one recurrent bias vector in the recurrent GEMM.

## 3.53. cudnnRNNClipMode\_t

`cudnnRNNClipMode_t` is an enumerated type used to select the LSTM cell clipping mode. It is used with `cudnnRNNSetClip()`, `cudnnRNNGetClip()` functions, and internally within LSTM cells.

### Values

`CUDNN_RNN_CLIP_NONE`

Disables LSTM cell clipping.

`CUDNN_RNN_CLIP_MINMAX`

Enables LSTM cell clipping.

## 3.54. cudnnRNNDataDescriptor\_t

**cudnnRNNDataDescriptor\_t** is a pointer to an opaque structure holding the description of a RNN data set. The function **cudnnCreateRNNDataDescriptor()** is used to create one instance, and **cudnnSetRNNDataDescriptor()** must be used to initialize this instance.

## 3.55. cudnnRNNDataLayout\_t

**cudnnRNNDataLayout\_t** is an enumerated type used to select the RNN data layout. It is used used in the API calls **cudnnGetRNNDataDescriptor** and **cudnnSetRNNDataDescriptor**.

### Values

**CUDNN\_RNN\_DATA\_LAYOUT\_SEQ\_MAJOR\_UNPACKED**

Data layout is padded, with outer stride from one time-step to the next.

**CUDNN\_RNN\_DATA\_LAYOUT\_SEQ\_MAJOR\_PACKED**

The sequence length is sorted and packed as in basic RNN API.

**CUDNN\_RNN\_DATA\_LAYOUT\_BATCH\_MAJOR\_UNPACKED**

Data layout is padded, with outer stride from one batch to the next.

## 3.56. cudnnRNNDescriptor\_t

**cudnnRNNDescriptor\_t** is a pointer to an opaque structure holding the description of an RNN operation. **cudnnCreateRNNDescriptor()** is used to create one instance, and **cudnnSetRNNDescriptor()** must be used to initialize this instance.

## 3.57. cudnnRNNInputMode\_t

**cudnnRNNInputMode\_t** is an enumerated type used to specify the behavior of the first layer in the **cudnnRNNForwardInference()**, **cudnnRNNForwardTraining()**, **cudnnRNNBackwardData()** and **cudnnRNNBackwardWeights()** routines.

### Values

**CUDNN\_LINEAR\_INPUT**

A biased matrix multiplication is performed at the input of the first recurrent layer.

**CUDNN\_SKIP\_INPUT**

No operation is performed at the input of the first recurrent layer. If

**CUDNN\_SKIP\_INPUT** is used the leading dimension of the input tensor must be equal to the hidden state size of the network.

## 3.58. cudnnRNNMode\_t

`cudnnRNNMode_t` is an enumerated type used to specify the type of network used in the `cudnnRNNForwardInference()`, `cudnnRNNForwardTraining()`, `cudnnRNNBackwardData()` and `cudnnRNNBackwardWeights()` routines.

### Values

#### CUDNN\_RNN\_RELU

A single-gate recurrent neural network with a ReLU activation function.

In the forward pass, the output  $\mathbf{h}_t$  for a given iteration can be computed from the recurrent input  $\mathbf{h}_{t-1}$  and the previous layer input  $\mathbf{x}_t$ , given the matrices  $\mathbf{W}$ ,  $\mathbf{R}$  and the bias vectors, where  $\text{ReLU}(\mathbf{x}) = \max(\mathbf{x}, 0)$ .

If `cudnnRNNBiasMode_t biasMode` in `rnnDesc` is `CUDNN_RNN_DOUBLE_BIAS` (default mode), then the following equation with biases  $\mathbf{b}_W$  and  $\mathbf{b}_R$  applies:

$$\mathbf{h}_t = \text{ReLU}(\mathbf{W}_i \mathbf{x}_t + \mathbf{R}_i \mathbf{h}_{t-1} + \mathbf{b}_{W_i} + \mathbf{b}_{R_i})$$

If `cudnnRNNBiasMode_t biasMode` in `rnnDesc` is `CUDNN_RNN_SINGLE_INP_BIAS` or `CUDNN_RNN_SINGLE_REC_BIAS`, then the following equation with bias  $\mathbf{b}$  applies:

$$\mathbf{h}_t = \text{ReLU}(\mathbf{W}_i \mathbf{x}_t + \mathbf{R}_i \mathbf{h}_{t-1} + \mathbf{b}_i)$$

If `cudnnRNNBiasMode_t biasMode` in `rnnDesc` is `CUDNN_RNN_NO_BIAS`, then the following equation applies:

$$\mathbf{h}_t = \text{ReLU}(\mathbf{W}_i \mathbf{x}_t + \mathbf{R}_i \mathbf{h}_{t-1})$$

#### CUDNN\_RNN\_TANH

A single-gate recurrent neural network with a `tanh` activation function.

In the forward pass, the output  $\mathbf{h}_t$  for a given iteration can be computed from the recurrent input  $\mathbf{h}_{t-1}$  and the previous layer input  $\mathbf{x}_t$ , given the matrices  $\mathbf{W}$ ,  $\mathbf{R}$  and the bias vectors, and where `tanh` is the hyperbolic tangent function.

If `cudnnRNNBiasMode_t biasMode` in `rnnDesc` is `CUDNN_RNN_DOUBLE_BIAS` (default mode), then the following equation with biases  $\mathbf{b}_W$  and  $\mathbf{b}_R$  applies:

$$\mathbf{h}_t = \tanh(\mathbf{W}_i \mathbf{x}_t + \mathbf{R}_i \mathbf{h}_{t-1} + \mathbf{b}_{W_i} + \mathbf{b}_{R_i})$$

If `cudnnRNNBiasMode_t biasMode` in `rnnDesc` is `CUDNN_RNN_SINGLE_INP_BIAS` or `CUDNN_RNN_SINGLE_REC_BIAS`, then the following equation with bias  $\mathbf{b}$  applies:

$$\mathbf{h}_t = \tanh(\mathbf{W}_i \mathbf{x}_t + \mathbf{R}_i \mathbf{h}_{t-1} + \mathbf{b}_i)$$

If `cudnnRNNBiasMode_t biasMode` in `rnnDesc` is `CUDNN_RNN_NO_BIAS`, then the following equation applies:

$$\mathbf{h}_t = \tanh(\mathbf{W}_i \mathbf{x}_t + \mathbf{R}_i \mathbf{h}_{t-1})$$

**CUDNN\_LSTM**

A four-gate Long Short-Term Memory network with no peephole connections.

In the forward pass, the output  $\mathbf{h}_t$  and cell output  $\mathbf{c}_t$  for a given iteration can be computed from the recurrent input  $\mathbf{h}_{t-1}$ , the cell input  $\mathbf{c}_{t-1}$  and the previous layer input  $\mathbf{x}_t$ , given the matrices  $\mathbf{W}$ ,  $\mathbf{R}$  and the bias vectors.

In addition, the following applies:

- ▶  $\sigma$  is the sigmoid operator such that:  $\sigma(\mathbf{x}) = 1 / (1 + e^{-\mathbf{x}})$ ,
- ▶  $\circ$  represents a point-wise multiplication,
- ▶  $\tanh$  is the hyperbolic tangent function, and
- ▶  $\mathbf{i}_t$ ,  $\mathbf{f}_t$ ,  $\mathbf{o}_t$ ,  $\mathbf{c}'_t$  represent the input, forget, output and new gates respectively.

If  `cudnnRNNBiasMode_t biasMode`  in  `rnnDesc`  is  `CUDNN_RNN_DOUBLE_BIAS`  (default mode), then the following equations with biases  $\mathbf{b}_W$  and  $\mathbf{b}_R$  apply:

$$\begin{aligned} \mathbf{i}_t &= \sigma(\mathbf{W}_i \mathbf{x}_t + \mathbf{R}_i \mathbf{h}_{t-1} + \mathbf{b}_{Wi} + \mathbf{b}_{Ri}) \\ \mathbf{f}_t &= \sigma(\mathbf{W}_f \mathbf{x}_t + \mathbf{R}_f \mathbf{h}_{t-1} + \mathbf{b}_{Wf} + \mathbf{b}_{Rf}) \\ \mathbf{o}_t &= \sigma(\mathbf{W}_o \mathbf{x}_t + \mathbf{R}_o \mathbf{h}_{t-1} + \mathbf{b}_{Wo} + \mathbf{b}_{Ro}) \\ \mathbf{c}'_t &= \tanh(\mathbf{W}_c \mathbf{x}_t + \mathbf{R}_c \mathbf{h}_{t-1} + \mathbf{b}_{Wc} + \mathbf{b}_{Rc}) \\ \mathbf{c}_t &= \mathbf{f}_t \circ \mathbf{c}_{t-1} + \mathbf{i}_t \circ \mathbf{c}'_t \\ \mathbf{h}_t &= \mathbf{o}_t \circ \tanh(\mathbf{c}_t) \end{aligned}$$

If  `cudnnRNNBiasMode_t biasMode`  in  `rnnDesc`  is  `CUDNN_RNN_SINGLE_INP_BIAS`  or  `CUDNN_RNN_SINGLE_REC_BIAS` , then the following equations with bias  $\mathbf{b}$  apply:

$$\begin{aligned} \mathbf{i}_t &= \sigma(\mathbf{W}_i \mathbf{x}_t + \mathbf{R}_i \mathbf{h}_{t-1} + \mathbf{b}_i) \\ \mathbf{f}_t &= \sigma(\mathbf{W}_f \mathbf{x}_t + \mathbf{R}_f \mathbf{h}_{t-1} + \mathbf{b}_f) \\ \mathbf{o}_t &= \sigma(\mathbf{W}_o \mathbf{x}_t + \mathbf{R}_o \mathbf{h}_{t-1} + \mathbf{b}_o) \\ \mathbf{c}'_t &= \tanh(\mathbf{W}_c \mathbf{x}_t + \mathbf{R}_c \mathbf{h}_{t-1} + \mathbf{b}_c) \\ \mathbf{c}_t &= \mathbf{f}_t \circ \mathbf{c}_{t-1} + \mathbf{i}_t \circ \mathbf{c}'_t \\ \mathbf{h}_t &= \mathbf{o}_t \circ \tanh(\mathbf{c}_t) \end{aligned}$$

If  `cudnnRNNBiasMode_t biasMode`  in  `rnnDesc`  is  `CUDNN_RNN_NO_BIAS` , then the following equations apply:

$$\begin{aligned} \mathbf{i}_t &= \sigma(\mathbf{W}_i \mathbf{x}_t + \mathbf{R}_i \mathbf{h}_{t-1}) \\ \mathbf{f}_t &= \sigma(\mathbf{W}_f \mathbf{x}_t + \mathbf{R}_f \mathbf{h}_{t-1}) \\ \mathbf{o}_t &= \sigma(\mathbf{W}_o \mathbf{x}_t + \mathbf{R}_o \mathbf{h}_{t-1}) \\ \mathbf{c}'_t &= \tanh(\mathbf{W}_c \mathbf{x}_t + \mathbf{R}_c \mathbf{h}_{t-1}) \\ \mathbf{c}_t &= \mathbf{f}_t \circ \mathbf{c}_{t-1} + \mathbf{i}_t \circ \mathbf{c}'_t \\ \mathbf{h}_t &= \mathbf{o}_t \circ \tanh(\mathbf{c}_t) \end{aligned}$$

**CUDNN\_GRU**

A three-gate network consisting of Gated Recurrent Units.

In the forward pass, the output  $\mathbf{h}_t$  for a given iteration can be computed from the recurrent input  $\mathbf{h}_{t-1}$  and the previous layer input  $\mathbf{x}_t$  given matrices  $\mathbf{W}$ ,  $\mathbf{R}$  and the bias vectors.

In addition,  $\sigma$  is the sigmoid operator:  $\sigma(\mathbf{x}) = 1 / (1 + e^{-\mathbf{x}})$ ,  $\circ$  represents a point-wise multiplication and  $\tanh$  is the hyperbolic tangent function.  $\mathbf{i}_t$ ,  $\mathbf{r}_t$ ,  $\mathbf{h}'_t$  represent the input, reset, new gates respectively.

If  `cudnnRNNBiasMode_t biasMode`  in  `rnnDesc`  is  `CUDNN_RNN_DOUBLE_BIAS`  (default mode), then the following equations with biases  $\mathbf{b}_W$  and  $\mathbf{b}_R$  apply:

$$\mathbf{i}_t = \sigma(\mathbf{W}_i \mathbf{x}_t + \mathbf{R}_i \mathbf{h}_{t-1} + \mathbf{b}_{Wi} + \mathbf{b}_{Ru})$$

$$\begin{aligned}
 r_t &= \sigma(W_r x_t + R_r h_{t-1} + b_{W_r} + b_{R_r}) \\
 h'_t &= \tanh(W_h x_t + r_t \circ (R_h h_{t-1} + b_{R_h}) + b_{W_h}) \\
 h_t &= (1 - i_t) \circ h'_t + i_t \circ h_{t-1}
 \end{aligned}$$

If  `cudnnRNNBiasMode_t biasMode`  in  `rnnDesc`  is

`CUDNN_RNN_SINGLE_INP_BIAS` , then the following equations with bias  `b`  apply:

$$\begin{aligned}
 i_t &= \sigma(W_i x_t + R_i h_{t-1} + b_i) \\
 r_t &= \sigma(W_r x_t + R_r h_{t-1} + b_r) \\
 h'_t &= \tanh(W_h x_t + r_t \circ (R_h h_{t-1} + b_{R_h}) + b_{W_h}) \\
 h_t &= (1 - i_t) \circ h'_t + i_t \circ h_{t-1}
 \end{aligned}$$

If  `cudnnRNNBiasMode_t biasMode`  in  `rnnDesc`  is

`CUDNN_RNN_SINGLE_REC_BIAS` , then the following equations with bias  `b`  apply:

$$\begin{aligned}
 i_t &= \sigma(W_i x_t + R_i h_{t-1} + b_i) \\
 r_t &= \sigma(W_r x_t + R_r h_{t-1} + b_r) \\
 h'_t &= \tanh(W_h x_t + r_t \circ (R_h h_{t-1} + b_{R_h})) \\
 h_t &= (1 - i_t) \circ h'_t + i_t \circ h_{t-1}
 \end{aligned}$$

If  `cudnnRNNBiasMode_t biasMode`  in  `rnnDesc`  is  `CUDNN_RNN_NO_BIAS` , then the following equations apply:

$$\begin{aligned}
 i_t &= \sigma(W_i x_t + R_i h_{t-1}) \\
 r_t &= \sigma(W_r x_t + R_r h_{t-1}) \\
 h'_t &= \tanh(W_h x_t + r_t \circ (R_h h_{t-1})) \\
 h_t &= (1 - i_t) \circ h'_t + i_t \circ h_{t-1}
 \end{aligned}$$

## 3.59. cudnnRNNPaddingMode\_t

`cudnnRNNPaddingMode_t`  is an enumerated type used to enable or disable the padded input/output.

**Values**

`CUDNN_RNN_PADDED_IO_DISABLED`

Disables the padded input/output.

`CUDNN_RNN_PADDED_IO_ENABLED`

Enables the padded input/output.

## 3.60. cudnnSamplerType\_t

`cudnnSamplerType_t`  is an enumerated type passed to  `cudnnSetSpatialTransformerNdDescriptor()` to select the sampler type to be used by  `cudnnSpatialTfSamplerForward()` and  `cudnnSpatialTfSamplerBackward()`.

**Values**

`CUDNN_SAMPLER_BILINEAR`

Selects the bilinear sampler.

## 3.61. cudnnSeqDataAxis\_t

`cudaSeqDataAxis_t` is an enumerated type to specify each supported sequence data axis.

For continued API compatibility, the user is recommended to use these enumerated labels when fetching and storing axes-arrays such as `dimA`, and `axes`.

User should:

1. Specify the dimension of sequence data buffer as follows:

```
int dimA[CUDNN_SEQDATA_DIM_COUNT];
dimA[CUDNN_SEQDATA_TIME_DIM] = n_timesteps;
dimA[CUDNN_SEQDATA_BATCH_DIM] = n_batch;
dimA[CUDNN_SEQDATA_BEAM_DIM] = beam_size;
dimA[CUDNN_SEQDATA_VECT_DIM] = hidden_size;
```

2. Specify the axes order as follows:

```
cudaSeqDataAxis_t axes[CUDNN_SEQDATA_DIM_COUNT] =
{CUDNN_SEQDATA_TIME_DIM,
 CUDNN_SEQDATA_BATCH_DIM,
 CUDNN_SEQDATA_BEAM_DIM,
 CUDNN_SEQDATA_VECT_DIM};
```

The `CUDNN_SEQDATA_DIM_COUNT` defines the number of supported dimensions or axes for sequential data. This value is currently set to 4.



The user is advised against using the equivalent integer values for the enumerated labels.

Member	Description
<code>CUDNN_SEQDATA_TIME_DIM = 0</code>	Time step index.
<code>CUDNN_SEQDATA_BATCH_DIM = 1</code>	Batch index.
<code>CUDNN_SEQDATA_BEAM_DIM = 2</code>	Beam index.
<code>CUDNN_SEQDATA_VECT_DIM = 3</code>	Hidden vector index.

## 3.62. `cudaSeqDataDescriptor_t`

`cudaSeqDataDescriptor_t` is a pointer to an opaque structure holding the description of sequence data. Use the function `cudaCreateSeqDataDescriptor` to create one instance, and `cudaDestroySeqDataDescriptor` to destroy a previously created descriptor.

## 3.63. `cudaSoftmaxAlgorithm_t`

`cudaSoftmaxAlgorithm_t` is used to select an implementation of the softmax function used in `cudaSoftmaxForward()` and `cudaSoftmaxBackward()`.

### Values

#### `CUDNN_SOFTMAX_FAST`

This implementation applies the straightforward softmax operation.

**CUDNN\_SOFTMAX\_ACCURATE**

This implementation scales each point of the softmax input domain by its maximum value to avoid potential floating point overflows in the softmax evaluation.

**CUDNN\_SOFTMAX\_LOG**

This entry performs the Log softmax operation, avoiding overflows by scaling each point in the input domain as in **CUDNN\_SOFTMAX\_ACCURATE**

## 3.64. cudnnSoftmaxMode\_t

**cudnnSoftmaxMode\_t** is used to select over which data the **cudnnSoftmaxForward()** and **cudnnSoftmaxBackward()** are computing their results.

### Values

**CUDNN\_SOFTMAX\_MODE\_INSTANCE**

The softmax operation is computed per image (N) across the dimensions C,H,W.

**CUDNN\_SOFTMAX\_MODE\_CHANNEL**

The softmax operation is computed per spatial location (H,W) per image (N) across the dimension C.

## 3.65. cudnnSpatialTransformerDescriptor\_t

**cudnnSpatialTransformerDescriptor\_t** is a pointer to an opaque structure holding the description of a spatial transformation operation. **cudnnCreateSpatialTransformerDescriptor()** is used to create one instance, **cudnnSetSpatialTransformerNdDescriptor()** is used to initialize this instance, **cudnnDestroySpatialTransformerDescriptor()** is used to destroy this instance.

## 3.66. cudnnStatus\_t

**cudnnStatus\_t** is an enumerated type used for function status returns. All cuDNN library functions return their status, which can be one of the following values:

### Values

**CUDNN\_STATUS\_SUCCESS**

The operation completed successfully.

**CUDNN\_STATUS\_NOT\_INITIALIZED**

The cuDNN library was not initialized properly. This error is usually returned when a call to **cudnnCreate()** fails or when **cudnnCreate()** has not been called prior to calling another cuDNN routine. In the former case, it is usually due to an error in the CUDA Runtime API called by **cudnnCreate()** or by an error in the hardware setup.



**CUDNN\_STATUS\_ALLOC\_FAILED**

Resource allocation failed inside the cuDNN library. This is usually caused by an internal `cudaMalloc()` failure.

To correct: prior to the function call, deallocate previously allocated memory as much as possible.

**CUDNN\_STATUS\_BAD\_PARAM**

An incorrect value or parameter was passed to the function.

To correct: ensure that all the parameters being passed have valid values.

**CUDNN\_STATUS\_ARCH\_MISMATCH**

The function requires a feature absent from the current GPU device. Note that cuDNN only supports devices with compute capabilities greater than or equal to 3.0.

To correct: compile and run the application on a device with appropriate compute capability.

**CUDNN\_STATUS\_MAPPING\_ERROR**

An access to GPU memory space failed, which is usually caused by a failure to bind a texture.

To correct: prior to the function call, unbind any previously bound textures.

Otherwise, this may indicate an internal error/bug in the library.

**CUDNN\_STATUS\_EXECUTION\_FAILED**

The GPU program failed to execute. This is usually caused by a failure to launch some cuDNN kernel on the GPU, which can occur for multiple reasons.

To correct: check that the hardware, an appropriate version of the driver, and the cuDNN library are correctly installed.

Otherwise, this may indicate an internal error/bug in the library.

**CUDNN\_STATUS\_INTERNAL\_ERROR**

An internal cuDNN operation failed.

**CUDNN\_STATUS\_NOT\_SUPPORTED**

The functionality requested is not presently supported by cuDNN.

**CUDNN\_STATUS\_LICENSE\_ERROR**

The functionality requested requires some license and an error was detected when trying to check the current licensing. This error can happen if the license is not present or is expired or if the environment variable `NVIDIA_LICENSE_FILE` is not set properly.

**CUDNN\_STATUS\_RUNTIME\_PREREQUISITE\_MISSING**

Runtime library required by RNN calls (`libcuda.so` or `nvcuda.dll`) cannot be found in predefined search paths.

**CUDNN\_STATUS\_RUNTIME\_IN\_PROGRESS**

Some tasks in the user stream are not completed.

**CUDNN\_STATUS\_RUNTIME\_FP\_OVERFLOW**

Numerical overflow occurred during the GPU kernel execution.

## 3.67. cudnnTensorDescriptor\_t

**cudnnCreateTensorDescriptor\_t** is a pointer to an opaque structure holding the description of a generic n-D dataset. **cudnnCreateTensorDescriptor()** is used to create one instance, and one of the routines **cudnnSetTensorNdDescriptor()**, **cudnnSetTensor4dDescriptor()** or **cudnnSetTensor4dDescriptorEx()** must be used to initialize this instance.

## 3.68. cudnnTensorFormat\_t

**cudnnTensorFormat\_t** is an enumerated type used by **cudnnSetTensor4dDescriptor()** to create a tensor with a pre-defined layout. For a detailed explanation of how these Tensors are arranged in memory, see [Data Layout Formats](#).

### Values

**CUDNN\_TENSOR\_NCHW**

This tensor format specifies that the data is laid out in the following order: batch size, feature maps, rows, columns. The strides are implicitly defined in such a way that the data are contiguous in memory with no padding between images, feature maps, rows, and columns; the columns are the inner dimension and the images are the outermost dimension.

**CUDNN\_TENSOR\_NHWC**

This tensor format specifies that the data is laid out in the following order: batch size, rows, columns, feature maps. The strides are implicitly defined in such a way that the data are contiguous in memory with no padding between images, rows, columns, and feature maps; the feature maps are the inner dimension and the images are the outermost dimension.

**CUDNN\_TENSOR\_NCHW\_VECT\_C**

This tensor format specifies that the data is laid out in the following order: batch size, feature maps, rows, columns. However, each element of the tensor is a vector of multiple feature maps. The length of the vector is carried by the data type of the tensor. The strides are implicitly defined in such a way that the data are contiguous in memory with no padding between images, feature maps, rows, and columns; the columns are the inner dimension and the images are the outermost dimension. This format is only supported with tensor data types CUDNN\_DATA\_INT8x4, CUDNN\_DATA\_INT8x32, and CUDNN\_DATA\_UINT8x4.

The CUDNN\_TENSOR\_NCHW\_VECT\_C can also be interpreted in the following way: The NCHW INT8x32 format is really  $N \times (C/32) \times H \times W \times 32$  (32 Cs for every

W), just as the NCHW INT8x4 format is  $N \times (C/4) \times H \times W \times 4$  (4 Cs for every W). Hence the "VECT\_C" name - each W is a vector (4 or 32) of Cs.

## 3.69. cudnnTensorTransformDescriptor\_t

`cudnnTensorTransformDescriptor_t` is an opaque structure containing the description of the Tensor transform. Use the `cudnnCreateTensorTransformDescriptor` function to create an instance of this descriptor, and `cudnnDestroyTensorTransformDescriptor` function to destroy a previously created instance.

## 3.70. cudnnWgradMode\_t

`cudnnWgradMode_t` is an enumerated type to select how the weight gradient output buffers should be updated with the partial gradients.

Member	Description
<code>CUDNN_WGRAD_MODE_ADD = 0</code>	Adds the partial gradients to the weight gradient output buffers (i.e., weight gradient output buffers = weight gradient output buffers + partial gradients).
<code>CUDNN_WGRAD_MODE_ADD = 1</code>	Replaces the weight gradient output buffer values with the partial gradients (i.e., weight gradient output buffers = partial gradients).

# Chapter 4.

## CUDNN API REFERENCE

This chapter describes the API of all the routines of the cuDNN library.

### 4.1. cudnnActivationBackward

```
cudaStatus_t cudnnActivationBackward(
    cudnnHandle_t      handle,
    cudnnActivationDescriptor_t activationDesc,
    const void*        alpha,
    const cudnnTensorDescriptor_t yDesc,
    const void*        y,
    const cudnnTensorDescriptor_t dyDesc,
    const void*        dy,
    const cudnnTensorDescriptor_t xDesc,
    const void*        x,
    const void*        beta,
    const cudnnTensorDescriptor_t dxDesc,
    void*              dx)
```

This routine computes the gradient of a neuron activation function.



In-place operation is allowed for this routine; i.e. `dy` and `dx` pointers may be equal. However, this requires the corresponding tensor descriptors to be identical (particularly, the strides of the input and output must match for in-place operation to be allowed).



All tensor formats are supported for 4 and 5 dimensions, however best performance is obtained when the strides of `yDesc` and `xDesc` are equal and **HW-packed**. For more than 5 dimensions the tensors must have their spatial dimensions packed.

#### Parameters

##### **handle**

*Input.* Handle to a previously created cuDNN context. See [cudnnHandle\\_t](#).

##### **activationDesc**

*Input.* Activation descriptor. See [cudnnActivationDescriptor\\_t](#).

**alpha, beta**

*Input.* Pointers to scaling factors (in host memory) used to blend the computation result with prior value in the output layer as follows:  $\text{dstValue} = \text{alpha}[0] * \text{result} + \text{beta}[0] * \text{priorDstValue}$ . Refer to this section for additional details.

**yDesc**

*Input.* Handle to the previously initialized input tensor descriptor. See [cudnnTensorDescriptor\\_t](#).

**y**

*Input.* Data pointer to GPU memory associated with the tensor descriptor **yDesc**.

**dyDesc**

*Input.* Handle to the previously initialized input differential tensor descriptor.

**dy**

*Input.* Data pointer to GPU memory associated with the tensor descriptor **dyDesc**.

**xDesc**

*Input.* Handle to the previously initialized output tensor descriptor.

**x**

*Input.* Data pointer to GPU memory associated with the output tensor descriptor **xDesc**.

**dxDesc**

*Input.* Handle to the previously initialized output differential tensor descriptor.

**dx**

*Output.* Data pointer to GPU memory associated with the output tensor descriptor **dxDesc**.

The possible error values returned by this function and their meanings are listed below.

**Returns****CUDNN\_STATUS\_SUCCESS**

The function launched successfully.

**CUDNN\_STATUS\_BAD\_PARAM**

At least one of the following conditions are met:

- ▶ The strides **nStride**, **cStride**, **hStride**, **wStride** of the input differential tensor and output differential tensors differ and in-place operation is used.

**CUDNN\_STATUS\_NOT\_SUPPORTED**

The function does not support the provided configuration. See the following for some examples of non-supported configurations:

- ▶ The dimensions **n**, **c**, **h**, **w** of the input tensor and output tensors differ.
- ▶ The **datatype** of the input tensor and output tensors differs.

- ▶ The strides `nStride`, `cStride`, `hStride`, `wStride` of the input tensor and the input differential tensor differ.
- ▶ The strides `nStride`, `cStride`, `hStride`, `wStride` of the output tensor and the output differential tensor differ.

#### CUDNN\_STATUS\_EXECUTION\_FAILED

The function failed to launch on the GPU.

## 4.2. cudnnActivationForward

```

cudnnStatus_t cudnnActivationForward(
    cudnnHandle_t handle,
    cudnnActivationDescriptor_t activationDesc,
    const void *alpha,
    const cudnnTensorDescriptor_t xDesc,
    const void *x,
    const void *beta,
    const cudnnTensorDescriptor_t yDesc,
    void *y)

```

This routine applies a specified neuron activation function element-wise over each input value.



In-place operation is allowed for this routine; i.e., `xData` and `yData` pointers may be equal. However, this requires `xDesc` and `yDesc` descriptors to be identical (particularly, the strides of the input and output must match for in-place operation to be allowed).



All tensor formats are supported for 4 and 5 dimensions, however best performance is obtained when the strides of `xDesc` and `yDesc` are equal and **HW-packed**. For more than 5 dimensions the tensors must have their spatial dimensions packed.

### Parameters

#### handle

*Input.* Handle to a previously created cuDNN context. See [cudnnHandle\\_t](#).

#### activationDesc

*Input.* Activation descriptor. See [cudnnActivationDescriptor\\_t](#).

#### alpha, beta

*Input.* Pointers to scaling factors (in host memory) used to blend the computation result with prior value in the output layer as follows:  $dstValue = alpha[0]*result + beta[0]*priorDstValue$ . [Please refer to this section for additional details.](#)

#### xDesc

*Input.* Handle to the previously initialized input tensor descriptor. See [cudnnTensorDescriptor\\_t](#).

#### x

*Input.* Data pointer to GPU memory associated with the tensor descriptor `xDesc`.

**yDesc**

*Input.* Handle to the previously initialized output tensor descriptor.

**y**

*Output.* Data pointer to GPU memory associated with the output tensor descriptor **yDesc**.

The possible error values returned by this function and their meanings are listed below.

**Returns****CUDNN\_STATUS\_SUCCESS**

The function launched successfully.

**CUDNN\_STATUS\_NOT\_SUPPORTED**

The function does not support the provided configuration.

**CUDNN\_STATUS\_BAD\_PARAM**

At least one of the following conditions are met:

- ▶ The parameter **mode** has an invalid enumerant value.
- ▶ The dimensions **n**, **c**, **h**, **w** of the input tensor and output tensors differ.
- ▶ The **datatype** of the input tensor and output tensors differs.
- ▶ The strides **nStride**, **cStride**, **hStride**, **wStride** of the input tensor and output tensors differ and in-place operation is used (i.e., **x** and **y** pointers are equal).

**CUDNN\_STATUS\_EXECUTION\_FAILED**

The function failed to launch on the GPU.

## 4.3. cudnnAddTensor

```

cudnnStatus_t cudnnAddTensor(
    cudnnHandle_t          handle,
    const void             *alpha,
    const cudnnTensorDescriptor_t aDesc,
    const void             *A,
    const void             *beta,
    const cudnnTensorDescriptor_t cDesc,
    void                  *C)

```

This function adds the scaled values of a bias tensor to another tensor. Each dimension of the bias tensor **A** must match the corresponding dimension of the destination tensor **C** or must be equal to 1. In the latter case, the same value from the bias tensor for those dimensions will be used to blend into the **C** tensor.



Up to dimension 5, all tensor formats are supported. Beyond those dimensions, this routine is not supported

**Parameters**

**handle**

*Input.* Handle to a previously created cuDNN context. See [cudnnHandle\\_t](#).

**alpha, beta**

*Input.* Pointers to scaling factors (in host memory) used to blend the source value with prior value in the destination tensor as follows:  $\text{dstValue} = \text{alpha}[0] * \text{srcValue} + \text{beta}[0] * \text{priorDstValue}$ . Refer to this section for additional details.

**aDesc**

*Input.* Handle to a previously initialized tensor descriptor. See [cudnnTensorDescriptor\\_t](#).

**A**

*Input.* Pointer to data of the tensor described by the **aDesc** descriptor.

**cDesc**

*Input.* Handle to a previously initialized tensor descriptor.

**C**

*Input/Output.* Pointer to data of the tensor described by the **cDesc** descriptor.

The possible error values returned by this function and their meanings are listed below.

**Returns****CUDNN\_STATUS\_SUCCESS**

The function executed successfully.

**CUDNN\_STATUS\_NOT\_SUPPORTED**

The function does not support the provided configuration.

**CUDNN\_STATUS\_BAD\_PARAM**

The dimensions of the bias tensor refer to an amount of data that is incompatible the output tensor dimensions or the **dataType** of the two tensor descriptors are different.

**CUDNN\_STATUS\_EXECUTION\_FAILED**

The function failed to launch on the GPU.

## 4.4. cudnnBatchNormalizationBackward

```

cudnnStatus_t cudnnBatchNormalizationBackward(
    cudnnHandle_t             handle,
    cudnnBatchNormMode_t     mode,
    const void                *alphaDataDiff,
    const void                *betaDataDiff,
    const void                *alphaParamDiff,
    const void                *betaParamDiff,
    const cudnnTensorDescriptor_t xDesc,
    const void                *x,
    const cudnnTensorDescriptor_t dyDesc,
    const void                *dy,
    const cudnnTensorDescriptor_t dxDesc,
    void                      *dx,
    const cudnnTensorDescriptor_t bnScaleBiasDiffDesc,
    const void                *bnScale,

```



```

void          *resultBnScaleDiff,
void          *resultBnBiasDiff,
double       epsilon,
const void   *savedMean,
const void   *savedInvVariance)

```

This function performs the backward batch normalization layer computation. This layer is based on the paper [Batch Normalization: Accelerating Deep Network Training by Reducing Internal Covariate Shift](#), S. Ioffe, C. Szegedy, 2015.



See `cudaDeriveBNTensorDescriptor` for the secondary tensor descriptor generation for the parameters using in this function.



Only 4D and 5D tensors are supported.



The `epsilon` value has to be the same during training, backpropagation and inference.



Higher performance can be obtained when HW-packed tensors are used for all of `x`, `dy`, `dx`.

## Parameters

### **handle**

*Input.* Handle to a previously created cuDNN library descriptor. See `cudaHandle_t`.

### **mode**

*Input.* Mode of operation (spatial or per-activation). See `cudaBatchNormMode_t`.

### **\*alphaDataDiff, \*betaDataDiff**

*Inputs.* Pointers to scaling factors (in host memory) used to blend the gradient output `dx` with a prior value in the destination tensor as follows:

$$\text{dstValue} = \text{alphaDataDiff}[0] * \text{resultValue} + \text{betaDataDiff}[0] * \text{priorDstValue}.$$

Refer to this section for additional details.

### **\*alphaParamDiff, \*betaParamDiff**

*Inputs.* Pointers to scaling factors (in host memory) used to blend the gradient outputs `resultBnScaleDiff` and `resultBnBiasDiff` with prior values in the destination tensor as follows:

$$\text{dstValue} = \text{alphaParamDiff}[0] * \text{resultValue} + \text{betaParamDiff}[0] * \text{priorDstValue}.$$

Refer to this section for additional details.

### **xDesc, dxDesc, dyDesc**

*Inputs.* Handles to the previously initialized tensor descriptors.

### **\*x**

*Input.* Data pointer to GPU memory associated with the tensor descriptor `xDesc`, for the layer's `x` data.

**\*dy**

*Inputs.* Data pointer to GPU memory associated with the tensor descriptor **dyDesc**, for the backpropagated differential **dy** input.

**\*dx**

*Inputs.* Data pointer to GPU memory associated with the tensor descriptor **dxDesc**, for the resulting differential output with respect to **x**.

**bnScaleBiasDiffDesc**

*Input.* Shared tensor descriptor for the following five tensors: **bnScale**, **resultBnScaleDiff**, **resultBnBiasDiff**, **savedMean**, **savedInvVariance**. The dimensions for this tensor descriptor are dependent on normalization mode. See [cudnnDeriveBNTensorDescriptor](#).



The data type of this tensor descriptor must be 'float' for FP16 and FP32 input tensors, and 'double' for FP64 input tensors.

**\*bnScale**

*Input.* Pointer in the device memory for the batch normalization **scale** parameter (in original paper the quantity **scale** is referred to as gamma).



The **bnBias** parameter is not needed for this layer's computation.

**resultBnScaleDiff, resultBnBiasDiff**

*Outputs.* Pointers in device memory for the resulting scale and bias differentials computed by this routine. Note that these scale and bias gradients are weight gradients specific to this batch normalization operation, and by definition are not backpropagated.

**epsilon**

*Input.* Epsilon value used in batch normalization formula. Its value should be equal to or greater than the value defined for CUDNN\_BN\_MIN\_EPSILON in cudnn.h. Same **epsilon** value should be used in forward and backward functions.

**\*savedMean, \*savedInvVariance**

*Inputs.* Optional cache parameters containing saved intermediate results that were computed during the forward pass. For this to work correctly, the layer's **x** and **bnScale** data has to remain unchanged until this backward function is called.



Both these parameters can be NULL but only at the same time. It is recommended to use this cache since the memory overhead is relatively small.

**Returns****CUDNN\_STATUS\_SUCCESS**

The computation was performed successfully.

**CUDNN\_STATUS\_NOT\_SUPPORTED**

The function does not support the provided configuration.

**CUDNN\_STATUS\_BAD\_PARAM**

At least one of the following conditions are met:

- ▶ Any of the pointers **alpha**, **beta**, **x**, **dy**, **dx**, **bnScale**, **resultBnScaleDiff**, **resultBnBiasDiff** is NULL.
- ▶ Number of **xDesc** or **yDesc** or **dxDesc** tensor descriptor dimensions is not within the range of [4,5] (only 4D and 5D tensors are supported.)
- ▶ **bnScaleBiasDiffDesc** dimensions are not 1xCx1x1 for 4D and 1xCx1x1x1 for 5D for spatial, and are not 1xCxHxW for 4D and 1xCxDxHxW for 5D for per-activation mode.
- ▶ Exactly one of **savedMean**, **savedInvVariance** pointers is NULL.
- ▶ **epsilon** value is less than CUDNN\_BN\_MIN\_EPSILON.
- ▶ Dimensions or data types mismatch for any pair of **xDesc**, **dyDesc**, **dxDesc**.

## 4.5. cudnnBatchNormalizationBackwardEx

```

cudnnStatus_t cudnnBatchNormalizationBackwardEx (
    cudnnHandle_t          handle,
    cudnnBatchNormMode_t  mode,
    cudnnBatchNormOps_t   bnOps,
    const void             *alphaDataDiff,
    const void             *betaDataDiff,
    const void             *alphaParamDiff,
    const void             *betaParamDiff,
    const cudnnTensorDescriptor_t xDesc,
    const void             *xData,
    const cudnnTensorDescriptor_t yDesc,
    const void             *yData,
    const cudnnTensorDescriptor_t dyDesc,
    const void             *dyData,
    const cudnnTensorDescriptor_t dzDesc,
    void                   *dzData,
    const cudnnTensorDescriptor_t dxDesc,
    void                   *dxData,
    const cudnnTensorDescriptor_t dBnScaleBiasDesc,
    const void             *bnScaleData,
    const void             *bnBiasData,
    void                   *dBnScaleData,
    void                   *dBnBiasData,
    double                 epsilon,
    const void             *savedMean,
    const void             *savedInvVariance,
    const cudnnActivationDescriptor_t activationDesc,
    void                   *workspace,
    size_t                  workspaceSizeInBytes,
    void                   *reserveSpace,
    size_t                  reserveSpaceSizeInBytes);

```

This function is an extension of the `cudnnBatchNormalizationBackward()` for performing the backward batch normalization layer computation with a fast NHWC semi-persistent kernel. This API will trigger the new semi-persistent NHWC kernel when the below conditions are true:

- ▶ All tensors, namely, **x**, **y**, **dz**, **dy**, **dx** must be NHWC-fully packed, and must be of the type CUDNN\_DATA\_HALF.
- ▶ The tensor C dimension should be a multiple of 4.

- ▶ The input parameter **mode** must be set to `CUDNN_BATCHNORM_SPATIAL_PERSISTENT`.
- ▶ **workspace** is not NULL.
- ▶ **workspaceSizeInBytes** is equal or larger than the amount required by `cudaDnnGetBatchNormalizationBackwardExWorkspaceSize()`.
- ▶ **reserveSpaceSizeInBytes** is equal or larger than the amount required by `cudaDnnGetBatchNormalizationTrainingExReserveSpaceSize()`.
- ▶ The content in **reserveSpace** stored by `cudaDnnBatchNormalizationForwardTrainingEx()` must be preserved.

If **workspace** is NULL and **workspaceSizeInBytes** of zero is passed in, this API will function exactly like the non-extended function `cudaDnnBatchNormalizationBackward`.

This workspace is not required to be clean. Moreover, the workspace does not have to remain unchanged between the forward and backward pass, as it is not used for passing any information.

This extended function can accept a **\*workspace** pointer to the GPU workspace, and **workspaceSizeInBytes**, the size of the workspace, from the user.

The **bnOps** input can be used to set this function to perform either only the batch normalization, or batch normalization followed by activation, or batch normalization followed by element-wise addition and then activation.

Only 4D and 5D tensors are supported. The **epsilon** value has to be the same during the training, the backpropagation and the inference.

When the tensor layout is NCHW, higher performance can be obtained when HW-packed tensors are used for **x**, **dy**, **dx**.

## Parameters

### **handle**

*Input.* Handle to a previously created cuDNN library descriptor. See `cudaDnnHandle_t`.

### **mode**

*Input.* Mode of operation (spatial or per-activation). See `cudaDnnBatchNormMode_t`.

### **bnOps**

*Input.* Mode of operation for the fast NHWC kernel. See `cudaDnnBatchNormOps_t`.

This input can be used to set this function to perform either only the batch normalization, or batch normalization followed by activation, or batch normalization followed by element-wise addition and then activation.

### **\*alphaDataDiff, \*betaDataDiff**

*Inputs.* Pointers to scaling factors (in host memory) used to blend the gradient output **dx** with a prior value in the destination tensor as follows:

**dstValue = alpha[0]\*resultValue + beta[0]\*priorDstValue.** Refer to this section for additional details.

**\*alphaParamDiff, \*betaParamDiff**

*Inputs.* Pointers to scaling factors (in host memory) used to blend the gradient outputs **dBnScaleData** and **dBnBiasData** with prior values in the destination tensor as follows:

**dstValue = alpha[0]\*resultValue + beta[0]\*priorDstValue.** Refer to [this section](#) for additional details.

**xDesc, \*x,yDesc, \*yData, dyDesc, \*dyData, dzDesc, \*dzData, dxDesc, \*dx/dt**

*Inputs.* Tensor descriptors and pointers in the device memory for the layer's **x** data, back propagated differential **dy** (inputs), the optional **y** input data, the optional **dz** output, and the **dx** output, which is the resulting differential with respect to **x**. See [cudnnTensorDescriptor\\_t](#).

**dBnScaleBiasDesc**

*Input.* Shared tensor descriptor for the following six tensors: **bnScaleData**, **bnBiasData**, **dBnScaleData**, **dBnBiasData**, **savedMean**, and **savedInvVariance**. See [cudnnDeriveBNTensorDescriptor](#).

The dimensions for this tensor descriptor are dependent on normalization mode.



Note: The data type of this tensor descriptor must be 'float' for FP16 and FP32 input tensors, and 'double' for FP64 input tensors.

See [cudnnTensorDescriptor\\_t](#).

**\*bnScaleData**

*Input.* Pointer in the device memory for the batch normalization scale parameter (in the [original paper](#) the quantity scale is referred to as gamma).

**\*bnBiasData**

*Input.* Pointers in the device memory for the batch normalization bias parameter (in the [original paper](#) bias is referred to as beta). This parameter is used only when activation should be performed.

**\*dBnScaleData, dBnBiasData**

*Inputs.* Pointers in the device memory for the gradients of **bnScaleData** and **bnBiasData**, respectively.

**epsilon**

*Input.* Epsilon value used in batch normalization formula. Its value should be equal to or greater than the value defined for CUDNN\_BN\_MIN\_EPSILON in cudnn.h. Same epsilon value should be used in forward and backward functions.

**\*savedMean, \*savedInvVariance**

*Inputs.* Optional cache parameters containing saved intermediate results computed during the forward pass. For this to work correctly, the layer's **x** and **bnScaleData**, **bnBiasData** data has to remain unchanged until this backward function is called. Note that both these parameters can be NULL but only at the same time. It is recommended to use this cache since the memory overhead is relatively small.

**activationDesc**

*Input.* Tensor descriptor for the activation operation.

**workspace**

*Input.* Pointer to the GPU workspace. If **workspace** is NULL and **workspaceSizeInBytes** of zero is passed in, then this API will function exactly like the non-extended function `cudaBatchNormalizationBackward()`.

**workspaceSizeInBytes**

*Input.* The size of the workspace. Must be large enough to trigger the fast NHWC semi-persistent kernel by this function.

**\*reserveSpace**

*Input.* Pointer to the GPU workspace for the **reserveSpace**.

**reserveSpaceSizeInBytes**

*Input.* The size of the **reserveSpace**. Must be equal or larger than the amount required by `cudaGetBatchNormalizationTrainingExReserveSpaceSize()`.

**Returns****CUDNN\_STATUS\_SUCCESS**

The computation was performed successfully.

**CUDNN\_STATUS\_NOT\_SUPPORTED**

The function does not support the provided configuration.

**CUDNN\_STATUS\_BAD\_PARAM**

At least one of the following conditions are met:

- ▶ Any of the pointers **alphaDataDiff**, **betaDataDiff**, **alphaParamDiff**, **betaParamDiff**, **x**, **dy**, **dx**, **bnScale**, **resultBnScaleDiff**, **resultBnBiasDiff** is NULL.
- ▶ Number of **xDesc** or **yDesc** or **dxDesc** tensor descriptor dimensions is not within the range of [4,5] (only 4D and 5D tensors are supported.)
- ▶ **dBnScaleBiasDesc** dimensions not 1xCx1x1 for 4D and 1xCx1x1x1 for 5D for spatial, and are not 1xCxHxW for 4D and 1xCxDxHxW for 5D for per-activation mode. .
- ▶ Exactly one of **savedMean**, **savedInvVariance** pointers is NULL.
- ▶ **epsilon** value is less than CUDNN\_BN\_MIN\_EPSILON.
- ▶ Dimensions or data types mismatch for any pair of **xDesc**, **dyDesc**, **dxDesc**.

## 4.6. cudaBatchNormalizationForwardInference

```

cudaStatus_t cudaBatchNormalizationForwardInference(
    cudaHandle_t          handle,
    cudaBatchNormMode_t  mode,
    const void            *alpha,
    const void            *beta,
    const cudaTensorDescriptor_t xDesc,
    const cudaTensorDescriptor_t *x,
    const cudaTensorDescriptor_t yDesc,
    void                 *y,
    const cudaTensorDescriptor_t bnScaleBiasMeanVarDesc,
    const void            *bnScale,
    const void            *bnBias,
    const void            *estimatedMean,
    const void            *estimatedVariance,
    double                epsilon)

```

This function performs the forward batch normalization layer computation for the inference phase. This layer is based on the paper *Batch Normalization: Accelerating Deep Network Training by Reducing Internal Covariate Shift*, S. Ioffe, C. Szegedy, 2015.



See `cudaDnnDeriveBNTensorDescriptor` for the secondary tensor descriptor generation for the parameters using in this function.



Only 4D and 5D tensors are supported.



The input transformation performed by this function is defined as:

$$y = \text{beta} * y + \text{alpha} * [\text{bnBias} + (\text{bnScale} * (\text{x} - \text{estimatedMean}) / \sqrt{\text{epsilon} + \text{estimatedVariance}})]$$

The `epsilon` value has to be the same during training, backpropagation and inference.



For training phase use `cudaDnnBatchNormalizationForwardTraining`.



Higher performance can be obtained when HW-packed tensors are used for all of `x` and `dx`.

## Parameters

### **handle**

*Input.* Handle to a previously created cuDNN library descriptor. See `cudaDnnHandle_t`.

### **mode**

*Input.* Mode of operation (spatial or per-activation). See `cudaDnnBatchNormMode_t`.

### **alpha, beta**

*Inputs.* Pointers to scaling factors (in host memory) used to blend the layer output value with prior value in the destination tensor as follows:

$$\text{dstValue} = \text{alpha}[0] * \text{resultValue} + \text{beta}[0] * \text{priorDstValue}.$$

Refer to this section for additional details.

### **xDesc, yDesc**

*Input.* Handles to the previously initialized tensor descriptors.

### **\*x**

*Input.* Data pointer to GPU memory associated with the tensor descriptor `xDesc`, for the layer's `x` input data.

**\*y**

*Input.* Data pointer to GPU memory associated with the tensor descriptor **yDesc**, for the **y** output of the batch normalization layer.

**bnScaleBiasMeanVarDesc, bnScale, bnBias**

*Inputs.* Tensor descriptor and pointers in device memory for the batch normalization scale and bias parameters (in the [original paper](#) bias is referred to as beta and scale as gamma).

**estimatedMean, estimatedVariance**

*Inputs.* Mean and variance tensors (these have the same descriptor as the bias and scale). The **resultRunningMean** and **resultRunningVariance**, accumulated during the training phase from the **cudaBatchNormalizationForwardTraining()** call, should be passed as inputs here.

**epsilon**

*Input.* Epsilon value used in the batch normalization formula. Its value should be equal to or greater than the value defined for CUDNN\_BN\_MIN\_EPSILON in **cuda.h**.

**Returns**

**CUDNN\_STATUS\_SUCCESS**

The computation was performed successfully.

**CUDNN\_STATUS\_NOT\_SUPPORTED**

The function does not support the provided configuration.

**CUDNN\_STATUS\_BAD\_PARAM**

At least one of the following conditions are met:

- ▶ One of the pointers **alpha, beta, x, y, bnScale, bnBias, estimatedMean, estimatedInvVariance** is NULL.
- ▶ Number of **xDesc** or **yDesc** tensor descriptor dimensions is not within the range of [4,5] (only 4D and 5D tensors are supported.)
- ▶ **bnScaleBiasMeanVarDesc** dimensions are not 1xCx1x1 for 4D and 1xCx1x1x1 for 5D for spatial, and are not 1xCxHxW for 4D and 1xCxDxHxW for 5D for per-activation mode.
- ▶ **epsilon** value is less than CUDNN\_BN\_MIN\_EPSILON.
- ▶ Dimensions or data types mismatch for **xDesc, yDesc**.

## 4.7. cudaBatchNormalizationForwardTraining

```

cudaStatus_t cudaBatchNormalizationForwardTraining(
    cudaHandle_t          handle,
    cudaBatchNormMode_t  mode,
    const void            *alpha,
    const void            *beta,
    const cudaTensorDescriptor_t  xDesc,
    const void            *x,

```



```

const cudnnTensorDescriptor_t  yDesc,
void                            *y,
const cudnnTensorDescriptor_t  bnScaleBiasMeanVarDesc,
const void                      *bnScale,
const void                      *bnBias,
double                          exponentialAverageFactor,
void                            *resultRunningMean,
double                          *resultRunningVariance,
void                            *resultSaveMean,
void                            *resultSaveInvVariance)

```

This function performs the forward batch normalization layer computation for the training phase. This layer is based on the paper *Batch Normalization: Accelerating Deep Network Training by Reducing Internal Covariate Shift*, S. Ioffe, C. Szegedy, 2015.



See [cudnnDeriveBNTensorDescriptor](#) for the secondary tensor descriptor generation for the parameters using in this function.



Only 4D and 5D tensors are supported.



The `epsilon` value has to be the same during training, backpropagation and inference.



For inference phase use [cudnnBatchNormalizationForwardInference](#).



Higher performance can be obtained when HW-packed tensors are used for both `x` and `y`.

## Parameters

### handle

Handle to a previously created cuDNN library descriptor. See [cudnnHandle\\_t](#).

### mode

Mode of operation (spatial or per-activation). See [cudnnBatchNormMode\\_t](#).

### alpha, beta

*Inputs.* Pointers to scaling factors (in host memory) used to blend the layer output value with prior value in the destination tensor as follows:

**dstValue = alpha[0]\*resultValue + beta[0]\*priorDstValue.** Refer to [this section for additional details](#).

### xDesc, yDesc

Tensor descriptors and pointers in device memory for the layer's `x` and `y` data. See [cudnnTensorDescriptor\\_t](#).

**\*x**

*Input.* Data pointer to GPU memory associated with the tensor descriptor **xDesc**, for the layer's **x** input data.

**\*y**

*Input.* Data pointer to GPU memory associated with the tensor descriptor **yDesc**, for the **y** output of the batch normalization layer.

### **bnScaleBiasMeanVarDesc**

Shared tensor descriptor desc for the secondary tensor that was derived by [cudnnDeriveBNTensorDescriptor](#). The dimensions for this tensor descriptor are dependent on the normalization mode.

### **bnScale, bnBias**

*Inputs.* Pointers in device memory for the batch normalization scale and bias parameters (in the [original paper](#) bias is referred to as beta and scale as gamma). Note that **bnBias** parameter can replace the previous layer's bias parameter for improved efficiency.

### **exponentialAverageFactor**

*Input.* Factor used in the moving average computation as follows:

$$\text{runningMean} = \text{runningMean} * (1 - \text{factor}) + \text{newMean} * \text{factor}$$

Use a **factor**=1/(1+n) at N-th call to the function to get Cumulative Moving Average (CMA) behavior such that:

$$\text{CMA}[n] = (\mathbf{x}[1] + \dots + \mathbf{x}[n]) / n. \text{ This is proved below:}$$

$$\text{Writing } \text{CMA}[n+1] = (n * \text{CMA}[n] + \mathbf{x}[n+1]) / (n+1)$$

$$= ((n+1) * \text{CMA}[n] - \text{CMA}[n]) / (n+1) + \mathbf{x}[n+1] / (n+1)$$

$$= \text{CMA}[n] * (1 - 1 / (n+1)) + \mathbf{x}[n+1] * 1 / (n+1)$$

$$= \text{CMA}[n] * (1 - \text{factor}) + \mathbf{x}[n+1] * \text{factor}.$$

### **resultRunningMean, resultRunningVariance**

*Inputs/Outputs.* Running mean and variance tensors (these have the same descriptor as the bias and scale). Both of these pointers can be NULL but only at the same time. The value stored in **resultRunningVariance** (or passed as an input in inference mode) is the sample variance, and is the moving average of variance[x] where variance is computed either over batch or spatial+batch dimensions depending on the mode. If these pointers are not NULL, the tensors should be initialized to some reasonable values or to 0.

### **epsilon**

*Input.* Epsilon value used in the batch normalization formula. Its value should be equal to or greater than the value defined for CUDNN\_BN\_MIN\_EPSILON in cudnn.h. Same **epsilon** value should be used in forward and backward functions.

### **resultSaveMean, resultSaveInvVariance**

*Outputs.* Optional cache to save intermediate results computed during the forward pass. These buffers can be used to speed up the backward pass when supplied to the

`cudaBatchNormalizationBackward()` function. The intermediate results stored in `resultSaveMean` and `resultSaveInvVariance` buffers should not be used directly by the user. Depending on the batch normalization mode, the results stored in `resultSaveInvVariance` may vary. For the cache to work correctly, the input layer data must remain unchanged until the backward function is called. Note that both parameters can be NULL but only at the same time. In such a case intermediate statistics will not be saved, and `cudaBatchNormalizationBackward()` will have to re-compute them. It is recommended to use this cache as the memory overhead is relatively small because these tensors have a much lower product of dimensions than the data tensors.

### Returns

#### CUDNN\_STATUS\_SUCCESS

The computation was performed successfully.

#### CUDNN\_STATUS\_NOT\_SUPPORTED

The function does not support the provided configuration.

#### CUDNN\_STATUS\_BAD\_PARAM

At least one of the following conditions are met:

- ▶ One of the pointers `alpha`, `beta`, `x`, `y`, `bnScale`, `bnBias` is NULL.
- ▶ Number of `xDesc` or `yDesc` tensor descriptor dimensions is not within the range of [4,5] (only 4D and 5D tensors are supported.)
- ▶ `bnScaleBiasMeanVarDesc` dimensions are not 1xCx1x1 for 4D and 1xCx1x1x1 for 5D for spatial, and are not 1xCxHxW for 4D and 1xCxDxHxW for 5D for per-activation mode.
- ▶ Exactly one of `resultSaveMean`, `resultSaveInvVariance` pointers is NULL.
- ▶ Exactly one of `resultRunningMean`, `resultRunningInvVariance` pointers is NULL.
- ▶ `epsilon` value is less than CUDNN\_BN\_MIN\_EPSILON.
- ▶ Dimensions or data types mismatch for `xDesc`, `yDesc`

## 4.8. cudaBatchNormalizationForwardTrainingEx

```

cudaStatus_t cudaBatchNormalizationForwardTrainingEx(
    cudaHandle_t          handle,
    cudaBatchNormMode_t  mode,
    cudaBatchNormOps_t   bnOps,
    const void           *alpha,
    const void           *beta,
    const cudaTensorDescriptor_t xDesc,
    const void           *xData,
    const cudaTensorDescriptor_t zDesc,
    const void           *zData,
    const cudaTensorDescriptor_t yDesc,
    void                 *yData,
    const cudaTensorDescriptor_t bnScaleBiasMeanVarDesc,
    const void           *bnScaleData,
    const void           *bnBiasData,
    double               exponentialAverageFactor,
    void                 *resultRunningMeanData,

```

```

void          *resultRunningVarianceData,
double       epsilon,
void         *saveMean,
void         *saveInvVariance,
const cudnnActivationDescriptor_t activationDesc,
void         *workspace,
size_t       workspaceSizeInBytes
void         *reserveSpace
size_t       reserveSpaceSizeInBytes);

```

This function is an extension of the `cudnnBatchNormalizationForwardTraining()` for performing the forward batch normalization layer computation.

This API will trigger the new semi-persistent NHWC kernel when the below conditions are true:

- ▶ All tensors, namely, **x**, **y**, **dz**, **dy**, **dx** must be NHWC-fully packed, and must be of the type CUDNN\_DATA\_HALF.
- ▶ The tensor C dimension should be a multiple of 4.
- ▶ The input parameter **mode** must be set to CUDNN\_BATCHNORM\_SPATIAL\_PERSISTENT.
- ▶ **workspace** is not NULL.
- ▶ **workspaceSizeInBytes** is equal or larger than the amount required by `cudnnGetBatchNormalizationForwardTrainingExWorkspaceSize()`.
- ▶ **reserveSpaceSizeInBytes** is equal or larger than the amount required by `cudnnGetBatchNormalizationTrainingExReserveSpaceSize()`.
- ▶ The content in **reserveSpace** stored by `cudnnBatchNormalizationForwardTrainingEx()` must be preserved.

If **workspace** is NULL and **workspaceSizeInBytes** of zero is passed in, this API will function exactly like the non-extended function `cudnnBatchNormalizationForwardTraining()`.

This workspace is not required to be clean. Moreover, the workspace does not have to remain unchanged between the forward and backward pass, as it is not used for passing any information.

This extended function can accept a **\*workspace** pointer to the GPU workspace, and **workspaceSizeInBytes**, the size of the workspace, from the user.

The **bnOps** input can be used to set this function to perform either only the batch normalization, or batch normalization followed by activation, or batch normalization followed by element-wise addition and then activation.

Only 4D and 5D tensors are supported. The **epsilon** value has to be the same during the training, the backpropagation and the inference.

When the tensor layout is NCHW, higher performance can be obtained when HW-packed tensors are used for **x**, **dy**, **dx**.

## Parameters

### handle

*Input.* Handle to a previously created cuDNN library descriptor. See `cudnnHandle_t`.

**mode**

*Input.* Mode of operation (spatial or per-activation). See [cudnnBatchNormMode\\_t](#).

**bnOps**

*Input.* Mode of operation for the fast NHWC kernel. See [cudnnBatchNormOps\\_t](#).

This input can be used to set this function to perform either only the batch normalization, or batch normalization followed by activation, or batch normalization followed by element-wise addition and then activation.

**\*alpha, \*beta**

*Inputs.* Pointers to scaling factors (in host memory) used to blend the layer output value with prior value in the destination tensor as follows:

**dstValue = alpha[0]\*resultValue + beta[0]\*priorDstValue.** Refer to this section for additional details.

**xDesc, \*xData, zDesc, \*zData, yDesc, \*yData**

Tensor descriptors and pointers in device memory for the layer's **x** and **y** data, and for the optional **z** tensor input for residual addition to the result of the batch normalization operation, prior to the activation. The optional tensor input **z** should be exact the same size as **x** and the final output **y**. This **z** input is element-wise added to the output of batch normalization. This addition optionally happens after batch normalization and before the activation. See [cudnnTensorDescriptor\\_t](#).

**bnScaleBiasMeanVarDesc**

Shared tensor descriptor desc for the secondary tensor that was derived by [cudnnDeriveBNTensorDescriptor\(\)](#). The dimensions for this tensor descriptor are dependent on the normalization mode.

**\*bnScaleData, \*bnBiasData**

*Inputs.* Pointers in the device memory for the for the batch normalization scale and bias data. In the [original paper](#) bias is referred to as beta and scale as gamma. Note that **bnBiasData** parameter can replace the previous operation's bias parameter for improved efficiency.

**exponentialAverageFactor**

*Input.* Factor used in the moving average computation as follows:

**runningMean = runningMean\*(1-factor) + newMean\*factor**

Use a **factor=1/(1+n)** at **N**-th call to the function to get Cumulative Moving Average (CMA) behavior such that:

**CMA[n] = (x[1]+...+x[n])/n.** This is proved below:

Writing **CMA[n+1] = (n\*CMA[n]+x[n+1])/(n+1)**

**= ((n+1)\*CMA[n]-CMA[n])/(n+1) + x[n+1]/(n+1)**

**= CMA[n]\*(1-1/(n+1))+x[n+1]\*1/(n+1)**

**= CMA[n]\*(1-factor) + x[n+1]\*factor.**

**\*resultRunningMeanData, \*resultRunningVarianceData**

*Inputs/Outputs.* Pointers to the running mean and running variance data. Both these pointers can be NULL but only at the same time. The value stored in **resultRunningVarianceData** (or passed as an input in inference mode) is the sample variance, and is the moving average of variance[x] where variance is computed either over batch or spatial+batch dimensions depending on the mode. If these pointers are not NULL, the tensors should be initialized to some reasonable values or to 0.

**epsilon**

*Input.* Epsilon value used in the batch normalization formula. Its value should be equal to or greater than the value defined for CUDNN\_BN\_MIN\_EPSILON in cudnn.h. Same **epsilon** value should be used in forward and backward functions.

**\*saveMean, \*saveInvVariance**

*Outputs.* Optional cache parameters containing saved intermediate results computed during the forward pass. For this to work correctly, the layer's **x** and **bnScaleData**, **bnBiasData** data has to remain unchanged until this backward function is called. Note that both these parameters can be NULL but only at the same time. It is recommended to use this cache since the memory overhead is relatively small.

**activationDesc**

*Input.* Tensor descriptor for the activation operation. When the **bnOps** input is set to either CUDNN\_BATCHNORM\_OPS\_BN\_ACTIVATION or CUDNN\_BATCHNORM\_OPS\_BN\_ADD\_ACTIVATION then this activation is used.

**\*workspace, workSpaceSizeInBytes**

*Inputs.* **\*workspace** is a pointer to the GPU workspace, and **workSpaceSizeInBytes** is the size of the workspace. When the **\*workspace** is not NULL and **\*workSpaceSizeInBytes** is large enough, and the tensor layout is NHWC and the data type configuration is supported, then this function will trigger a new semi-persistent NHWC kernel for batch normalization. The workspace is not required to be clean. Also, the workspace does not need to remain unchanged between the forward and backward passes.

**\*reserveSpace**

*Input.* Pointer to the GPU workspace for the **reserveSpace**.

**reserveSpaceSizeInBytes**

*Input.* The size of the **reserveSpace**. Must be equal or larger than the amount required by  `cudnnGetBatchNormalizationTrainingExReserveSpaceSize ()` .

**Returns****CUDNN\_STATUS\_SUCCESS**

The computation was performed successfully.

**CUDNN\_STATUS\_NOT\_SUPPORTED**

The function does not support the provided configuration.

**CUDNN\_STATUS\_BAD\_PARAM**

At least one of the following conditions are met:

- ▶ One of the pointers **alpha**, **beta**, **x**, **y**, **bnScaleData**, **bnBiasData** is NULL.

- ▶ Number of **xDesc** or **yDesc** tensor descriptor dimensions is not within the [4,5] range (only 4D and 5D tensors are supported.).
- ▶ **bnScaleBiasMeanVarDesc** dimensions are not 1xCx1x1 for 4D and 1xCx1x1x1 for 5D for spatial, and are not 1xCxHxW for 4D and 1xCxDxHxW for 5D for per-activation mode.
- ▶ Exactly one of **saveMean**, **saveInvVariance** pointers is NULL.
- ▶ Exactly one of **resultRunningMeanData**, **resultRunningInvVarianceData** pointers is NULL.
- ▶ **epsilon** value is less than CUDNN\_BN\_MIN\_EPSILON.
- ▶ Dimensions or data types mismatch for **xDesc**, **yDesc**

## 4.9. cudnnConvolutionBackwardBias

```

cudnnStatus_t cudnnConvolutionBackwardBias(
    cudnnHandle_t          handle,
    const void             *alpha,
    const cudnnTensorDescriptor_t dyDesc,
    const void             *dy,
    const void             *beta,
    const cudnnTensorDescriptor_t dbDesc,
    void                   *db)

```

This function computes the convolution function gradient with respect to the bias, which is the sum of every element belonging to the same feature map across all of the images of the input tensor. Therefore, the number of elements produced is equal to the number of features maps of the input tensor.

### Parameters

#### handle

*Input.* Handle to a previously created cuDNN context. See [cudnnHandle\\_t](#).

#### alpha, beta

*Input.* Pointers to scaling factors (in host memory) used to blend the computation result with prior value in the output layer as follows:  $dstValue = alpha[0]*result + beta[0]*priorDstValue$ . [Refer to this section for additional details.](#)

#### dyDesc

*Input.* Handle to the previously initialized input tensor descriptor. See [cudnnTensorDescriptor\\_t](#).

#### dy

*Input.* Data pointer to GPU memory associated with the tensor descriptor **dyDesc**.

#### dbDesc

*Input.* Handle to the previously initialized output tensor descriptor.

#### db

*Output.* Data pointer to GPU memory associated with the output tensor descriptor **dbDesc**.

The possible error values returned by this function and their meanings are listed below.

**Returns****CUDNN\_STATUS\_SUCCESS**

The operation was launched successfully.

**CUDNN\_STATUS\_NOT\_SUPPORTED**

The function does not support the provided configuration.

**CUDNN\_STATUS\_BAD\_PARAM**

At least one of the following conditions are met:

- ▶ One of the parameters **n**, **height**, **width** of the output tensor is not 1.
- ▶ The numbers of feature maps of the input tensor and output tensor differ.
- ▶ The **dataType** of the two tensor descriptors are different.

## 4.10. cudnnConvolutionBackwardData

```

cudnnStatus_t cudnnConvolutionBackwardData(
    cudnnHandle_t          handle,
    const void*           *alpha,
    const cudnnFilterDescriptor_t wDesc,
    const void*           *w,
    const cudnnTensorDescriptor_t dyDesc,
    const void*           *dy,
    const cudnnConvolutionDescriptor_t convDesc,
    cudnnConvolutionBwdDataAlgo_t algo,
    void*                  *workSpace,
    size_t                 workSpaceSizeInBytes,
    const void*           *beta,
    const cudnnTensorDescriptor_t dxDesc,
    void*                  *dx)

```

This function computes the convolution data gradient of the tensor **dy**, where **y** is the output of the forward convolution in **cudnnConvolutionForward()**. It uses the specified **algo**, and returns the results in the output tensor **dx**. Scaling factors **alpha** and **beta** can be used to scale the computed result or accumulate with the current **dx**.

**Parameters****handle**

*Input.* Handle to a previously created cuDNN context. See [cudnnHandle\\_t](#).

**alpha, beta**

*Input.* Pointers to scaling factors (in host memory) used to blend the computation result with prior value in the output layer as follows:  $\text{dstValue} = \text{alpha}[0] * \text{result} + \text{beta}[0] * \text{priorDstValue}$ . Refer to this section for additional details.

**wDesc**

*Input.* Handle to a previously initialized filter descriptor. See [cudnnFilterDescriptor\\_t](#).

**w**

*Input.* Data pointer to GPU memory associated with the filter descriptor **wDesc**.



**dyDesc**

*Input.* Handle to the previously initialized input differential tensor descriptor. See [cudnnTensorDescriptor\\_t](#).

**dy**

*Input.* Data pointer to GPU memory associated with the input differential tensor descriptor **dyDesc**.

**convDesc**

*Input.* Previously initialized convolution descriptor. See [cudnnConvolutionDescriptor\\_t](#).

**algo**

*Input.* Enumerant that specifies which backward data convolution algorithm should be used to compute the results. See [cudnnConvolutionBwdDataAlgo\\_t](#).

**workSpace**

*Input.* Data pointer to GPU memory to a workspace needed to able to execute the specified algorithm. If no workspace is needed for a particular algorithm, that pointer can be nil.

**workSpaceSizeInBytes**

*Input.* Specifies the size in bytes of the provided **workSpace**.

**dxDesc**

*Input.* Handle to the previously initialized output tensor descriptor.

**dx**

*Input/Output.* Data pointer to GPU memory associated with the output tensor descriptor **dxDesc** that carries the result.

**TABLE OF THE SUPPORTED CONFIGURATIONS**

This function supports the following combinations of data types for **wDesc**, **dyDesc**, **convDesc**, and **dxDesc**. See the following table for a list of the supported configurations.

Data Type Configurations	wDesc's, dyDesc's and dxDesc's Data Type	convDesc's Data Type
TRUE_HALF_CONFIG (only supported on architectures with true fp16 support, i.e., compute capability 5.3 and later).	CUDNN_DATA_HALF	CUDNN_DATA_HALF
PSEUDO_HALF_CONFIG	CUDNN_DATA_HALF	CUDNN_DATA_FLOAT
FLOAT_CONFIG	CUDNN_DATA_FLOAT	CUDNN_DATA_FLOAT

Data Type Configurations	wDesc's, dyDesc's and dxDesc's Data Type	convDesc's Data Type
DOUBLE_CONFIG	CUDNN_DATA_DOUBLE	CUDNN_DATA_DOUBLE

 Specifying a separate algorithm can cause changes in performance, support and computation determinism. See the following for a list of algorithm options, and their respective supported parameters and deterministic behavior.

### TABLE OF THE SUPPORTED ALGORITHMS

The table below shows the list of the supported 2D and 3D convolutions. The 2D convolutions are described first, followed by the 3D convolutions.

For the following terms, the short-form versions shown in the paranthesis are used in the table below, for brevity:

- ▶ CUDNN\_CONVOLUTION\_BWD\_DATA\_ALGO\_0 (**\_ALGO\_0**)
- ▶ CUDNN\_CONVOLUTION\_BWD\_DATA\_ALGO\_1 (**\_ALGO\_1**)
- ▶ CUDNN\_CONVOLUTION\_BWD\_DATA\_ALGO\_FFT (**\_FFT**)
- ▶ CUDNN\_CONVOLUTION\_BWD\_DATA\_ALGO\_FFT\_TILING (**\_FFT\_TILING**)
- ▶ CUDNN\_CONVOLUTION\_BWD\_DATA\_ALGO\_WINOGRAD (**\_WINOGRAD**)
- ▶ CUDNN\_CONVOLUTION\_BWD\_DATA\_ALGO\_WINOGRAD\_NONFUSED (**\_WINOGRAD\_NONFUSED**)
- ▶ CUDNN\_TENSOR\_NCHW (**\_NCHW**)
- ▶ CUDNN\_TENSOR\_NHWC (**\_NHWC**)
- ▶ CUDNN\_TENSOR\_NCHW\_VECT\_C (**\_NCHW\_VECT\_C**)

#### FOR 2D CONVOLUTIONS.

Filter descriptor wDesc: <b>_NHWC</b> . See <a href="#">cudnnTensorFormat_t</a> .					
Algo Name (see below for 3D Convolution)	Deterministic (Yes or No)	Tensor Formats Supported for dyDesc	Tensor Formats Supported for dxDesc	Data Type Configurations Supported	Important
<b>_ALGO_1</b>		NHWC HWC- packed	NHWC HWC- packed	- TRUE_HALF_CONFIG, - PSEUDO_HALF_CONFIG, and - FLOAT_CONFIG	
Filter descriptor wDesc: <b>_NCHW</b> .					
Algo Name	Deterministic (Yes or No)	Tensor Formats Supported for dyDesc	Tensor Formats Supported for dxDesc	Data Type Configurations Supported	Important
<b>_ALGO_0</b>	No	NCHW CHW- packed	All except <b>_NCHW_VECT_C</b>	- PSEUDO_HALF_CONFIG	- <b>Dilation</b> : greater than 0 for all dimensions

				<ul style="list-style-type: none"> <li>- FLOAT_CONFIG, and</li> <li>- DOUBLE_CONFIG</li> </ul>	<ul style="list-style-type: none"> <li>- convDesc Group Count Support: Greater than 0.</li> </ul>
_ALGO_1	Yes	NCHW CHW-packed	_All except _NCHW_VECT	<ul style="list-style-type: none"> <li>- TRUE_HALF_CONFIG,</li> <li>- PSEUDO_HALF_CONFIG</li> <li>- FLOAT_CONFIG, and</li> <li>- DOUBLE_CONFIG</li> </ul>	<ul style="list-style-type: none"> <li>- Dilation: 1 for all dimensions</li> <li>- convDesc Group Count Support: Greater than 0.</li> </ul>
_FFT	Yes	NCHW CHW-packed	NCHW HW-packed	<ul style="list-style-type: none"> <li>- PSEUDO_HALF_CONFIG and</li> <li>- FLOAT_CONFIG</li> </ul>	<ul style="list-style-type: none"> <li>- Dilation: 1 for all dimensions</li> <li>- convDesc Group Count Support: Greater than 0.</li> <li>- dxDesc's feature map height + 2 * convDesc's zero-padding height must equal 256 or less</li> <li>- dxDesc's feature map width + 2 * convDesc's zero-padding width must equal 256 or less</li> <li>- convDesc's vertical and horizontal filter stride must equal 1</li> <li>- wDesc's filter height must be greater than convDesc's zero-padding height</li> <li>- wDesc's filter width must be greater than convDesc's zero-padding width</li> </ul>
_FFT_TILING	Yes	NCHW CHW-packed	NCHW HW-packed	<ul style="list-style-type: none"> <li>- PSEUDO_HALF_CONFIG and</li> <li>- FLOAT_CONFIG</li> <li>- DOUBLE_CONFIG is also supported when the task can be handled by 1D FFT, ie, one of the filter dimension,</li> </ul>	<ul style="list-style-type: none"> <li>- Dilation: 1 for all dimensions</li> <li>- convDesc Group Count Support: Greater than 0.</li> <li>- When neither of wDesc's filter dimension is 1, the filter width and height must not be larger than 32</li> </ul>

				width or height is 1.	<ul style="list-style-type: none"> <li>- When either of <code>wDesc</code>'s filter dimension is 1, the largest filter dimension should not exceed 256</li> <li>- <code>convDesc</code>'s vertical and horizontal filter stride must equal 1 when either the filter width or filter height is 1, otherwise the stride can be 1 or 2</li> <li>- <code>wDesc</code>'s filter height must be greater than <code>convDesc</code>'s zero-padding height</li> <li>- <code>wDesc</code>'s filter width must be greater than <code>convDesc</code>'s zero-padding width</li> </ul>
<code>_WINOGRAD</code>	Yes	NCHW CHW-packed	All except <code>_NCHW_VECT</code>	<ul style="list-style-type: none"> <li>- <code>PSEUDO_HALF_CONFIG</code> and</li> <li>- <code>FLOAT_CONFIG</code></li> </ul>	<ul style="list-style-type: none"> <li>- <b>Dilation:</b> 1 for all dimensions</li> <li>- <code>convDesc</code> Group Count Support: Greater than 0.</li> <li>- <code>convDesc</code>'s vertical and horizontal filter stride must equal 1</li> <li>- <code>wDesc</code>'s filter height must be 3</li> <li>- <code>wDesc</code>'s filter width must be 3</li> </ul>
<code>_WINOGRAD_NONFUSED</code>	Yes	NCHW CHW-packed	All except <code>_NCHW_VECT</code>	<ul style="list-style-type: none"> <li>- <code>TRUE_HALF_CONFIG</code>,</li> <li>- <code>PSEUDO_HALF_CONFIG</code> and</li> <li>- <code>FLOAT_CONFIG</code></li> </ul>	<ul style="list-style-type: none"> <li>- <b>Dilation:</b> 1 for all dimensions</li> <li>- <code>convDesc</code> Group Count Support: Greater than 0.</li> <li>- <code>convDesc</code>'s vertical and horizontal filter stride must equal 1</li> <li>- <code>wDesc</code>'s filter (height, width) must be (3,3) or (5,5)</li> </ul>

					- If <code>wDesc</code> 's filter (height, width) is (5,5) then the data type config <code>TRUE_HALF_CONFIG</code> is not supported
--	--	--	--	--	---

**FOR 3D CONVOLUTIONS.**

Filter descriptor <code>wDesc</code> : <code>_NCHW</code>					
Algo Name (3D Convolutions)	Deterministic (Yes or No)	Tensor Formats Supported for <code>dyDesc</code>	Tensor Formats Supported for <code>dxDesc</code>	Data Type Configurations Support	Important
<code>_ALGO_0</code>	Yes	NCDHW CDHW-packed	All except <code>_NCDHW_VECTOR</code>	- <code>PSEUDO_HALF_CONFIG</code> - <code>FLOAT_CONFIG</code> , and - <code>DOUBLE_CONFIG</code> .	- <b>Dilation</b> : greater than 0 for all dimensions - <code>convDesc</code> Group Count Support: Greater than 0.
<code>_ALGO_1</code>	Yes	NCDHW-fully-packed	NCDHW-fully-packed	- <code>TRUE_HALF_CONFIG</code> , - <code>PSEUDO_HALF_CONFIG</code> - <code>FLOAT_CONFIG</code> , and - <code>DOUBLE_CONFIG</code> .	- <b>Dilation</b> : 1 for all dimensions - <code>convDesc</code> Group Count Support: Greater than 0.
<code>_FFT_TILING</code>	Yes	NCDHW CDHW-packed	NCDHW DHW-packed	- <code>PSEUDO_HALF_CONFIG</code> - <code>FLOAT_CONFIG</code> , and - <code>DOUBLE_CONFIG</code> .	- <b>Dilation</b> : 1 for all dimensions - <code>convDesc</code> Group Count Support: Greater than 0. - <code>wDesc</code> 's filter height must equal 16 or less - <code>wDesc</code> 's filter width must equal 16 or less - <code>wDesc</code> 's filter depth must equal 16 or less - <code>convDesc</code> 's must have all filter strides equal to 1 - <code>wDesc</code> 's filter height must be greater than <code>convDesc</code> 's zero-padding height

					<ul style="list-style-type: none"> <li>- <b>wDesc</b>'s filter width must be greater than <b>convDesc</b>'s zero-padding width</li> <li>- <b>wDesc</b>'s filter depth must be greater than <b>convDesc</b>'s zero-padding width</li> </ul>
--	--	--	--	--	--

## Returns

### CUDNN\_STATUS\_SUCCESS

The operation was launched successfully.

### CUDNN\_STATUS\_BAD\_PARAM

At least one of the following conditions are met:

- ▶ At least one of the following is NULL: **handle**, **dyDesc**, **wDesc**, **convDesc**, **dxDesc**, **dy**, **w**, **dx**, **alpha**, **beta**
- ▶ **wDesc** and **dyDesc** have a non-matching number of dimensions
- ▶ **wDesc** and **dxDesc** have a non-matching number of dimensions
- ▶ **wDesc** has fewer than three number of dimensions
- ▶ **wDesc**, **dxDesc** and **dyDesc** have a non-matching data type.
- ▶ **wDesc** and **dxDesc** have a non-matching number of input feature maps per image (or group in case of Grouped Convolutions).
- ▶ **dyDescs** 's spatial sizes do not match with the expected size as determined by `cudaGetConvolutionNdForwardOutputDim`

### CUDNN\_STATUS\_NOT\_SUPPORTED

At least one of the following conditions are met:

- ▶ **dyDesc** or **dxDesc** have negative tensor striding
- ▶ **dyDesc**, **wDesc** or **dxDesc** has a number of dimensions that is not 4 or 5
- ▶ The chosen algo does not support the parameters provided; see above for exhaustive list of parameter support for each algo
- ▶ **dyDesc** or **wDesc** indicate an output channel count that isn't a multiple of group count (if group count has been set in **convDesc**).

### CUDNN\_STATUS\_MAPPING\_ERROR

An error occurs during the texture binding of the filter data or the input differential tensor data

### CUDNN\_STATUS\_EXECUTION\_FAILED

The function failed to launch on the GPU.

## 4.11. cudnnConvolutionBackwardFilter

```

cudnnStatus_t cudnnConvolutionBackwardFilter(
    cudnnHandle_t handle,

```

```

const void                *alpha,
const cudnnTensorDescriptor_t xDesc,
const void                *x,
const cudnnTensorDescriptor_t dyDesc,
const void                *dy,
const cudnnConvolutionDescriptor_t convDesc,
cudnnConvolutionBwdFilterAlgo_t algo,
void                      *workSpace,
size_t                    workSpaceSizeInBytes,
const void                *beta,
const cudnnFilterDescriptor_t dwDesc,
void                      *dw)

```

This function computes the convolution weight (filter) gradient of the tensor **dy**, where **y** is the output of the forward convolution in `cudnnConvolutionForward()`. It uses the specified **algo**, and returns the results in the output tensor **dw**. Scaling factors **alpha** and **beta** can be used to scale the computed result or accumulate with the current **dw**.

### Parameters

#### handle

*Input.* Handle to a previously created cuDNN context. See [cudnnHandle\\_t](#).

#### alpha, beta

*Input.* Pointers to scaling factors (in host memory) used to blend the computation result with prior value in the output layer as follows:  $\text{dstValue} = \text{alpha}[0] * \text{result} + \text{beta}[0] * \text{priorDstValue}$ . [Refer to this section for additional details.](#)

#### xDesc

*Input.* Handle to a previously initialized tensor descriptor. See [cudnnTensorDescriptor\\_t](#).

#### x

*Input.* Data pointer to GPU memory associated with the tensor descriptor **xDesc**.

#### dyDesc

*Input.* Handle to the previously initialized input differential tensor descriptor.

#### dy

*Input.* Data pointer to GPU memory associated with the backpropagation gradient tensor descriptor **dyDesc**.

#### convDesc

*Input.* Previously initialized convolution descriptor. See [cudnnConvolutionDescriptor\\_t](#).

#### algo

*Input.* Enumerant that specifies which convolution algorithm should be used to compute the results. See [cudnnConvolutionBwdFilterAlgo\\_t](#).

#### workSpace

*Input.* Data pointer to GPU memory to a workspace needed to able to execute the specified algorithm. If no workspace is needed for a particular algorithm, that pointer can be nil.

**workspaceSizeInBytes**

*Input.* Specifies the size in bytes of the provided **workspace**.

**dwDesc**

*Input.* Handle to a previously initialized filter gradient descriptor. See [cudnnFilterDescriptor\\_t](#).

**dw**

*Input/Output.* Data pointer to GPU memory associated with the filter gradient descriptor **dwDesc** that carries the result.

**TABLE OF THE SUPPORTED CONFIGURATIONS**

This function supports the following combinations of data types for **xDesc**, **dyDesc**, **convDesc**, and **dwDesc**. See the following table for a list of the supported configurations.

Data Type Configurations	xDesc's, dyDesc's and dwDesc's Data Type	convDesc's Data Type
TRUE_HALF_CONFIG (only supported on architectures with true fp16 support, i.e., compute capability 5.3 and later).	CUDNN_DATA_HALF	CUDNN_DATA_HALF
PSEUDO_HALF_CONFIG	CUDNN_DATA_HALF	CUDNN_DATA_FLOAT
FLOAT_CONFIG	CUDNN_DATA_FLOAT	CUDNN_DATA_FLOAT
DOUBLE_CONFIG	CUDNN_DATA_DOUBLE	CUDNN_DATA_DOUBLE



Specifying a separate algorithm can cause changes in performance, support and computation determinism. See the following for an exhaustive list of algorithm options and their respective supported parameters and deterministic behavior.

**TABLE OF THE SUPPORTED ALGORITHMS**

The table below shows the list of the supported 2D and 3D convolutions. The 2D convolutions are described first, followed by the 3D convolutions.

For the following terms, the short-form versions shown in the parenthesis are used in the table below, for brevity:

- ▶ CUDNN\_CONVOLUTION\_BWD\_FILTER\_ALGO\_0 (**\_ALGO\_0**)
- ▶ CUDNN\_CONVOLUTION\_BWD\_FILTER\_ALGO\_1 (**\_ALGO\_1**)
- ▶ CUDNN\_CONVOLUTION\_BWD\_FILTER\_ALGO\_3 (**\_ALGO\_3**)
- ▶ CUDNN\_CONVOLUTION\_BWD\_FILTER\_ALGO\_FFT (**\_FFT**)
- ▶ CUDNN\_CONVOLUTION\_BWD\_FILTER\_ALGO\_FFT\_TILING (**\_FFT\_TILING**)
- ▶ CUDNN\_CONVOLUTION\_BWD\_FILTER\_ALGO\_WINOGRAD\_NONFUSED (**\_WINOGRAD\_NONFUSED**)
- ▶ CUDNN\_TENSOR\_NCHW (**\_NCHW**)
- ▶ CUDNN\_TENSOR\_NHWC (**\_NHWC**)
- ▶ CUDNN\_TENSOR\_NCHW\_VECT\_C (**\_NCHW\_VECT\_C**)



FOR 2D CONVOLUTIONS.

Filter descriptor <code>dwDesc</code> : <code>_NHWC</code> . See <a href="#">cudnnTensorFormat_t</a> .					
Algo Name (see below for 3D Convolutions)	Deterministic (Yes or No)	Tensor Formats Supported for <code>xDesc</code>	Tensor Formats Supported for <code>dyDesc</code>	Data Type Configurations Supported	Important
<code>_ALGO_0</code> , and <code>_ALGO_1</code>		NHWC HWC- packed	NHWC HWC- packed	- PSEUDO_HALF_CONFIG, and - FLOAT_CONFIG	
Filter descriptor <code>wDesc</code> : <code>_NCHW</code> .					
Algo Name	Deterministic (Yes or No)	Tensor Formats Supported for <code>xDesc</code>	Tensor Formats Supported for <code>dyDesc</code>	Data Type Configurations Supported	Important
<code>_ALGO_0</code>	No	All except <code>_NCHW_VECTOR</code>	NCHW CHW- packed	- PSEUDO_HALF_CONFIG, and - FLOAT_CONFIG, and - DOUBLE_CONFIG	- <b>Dilation</b> : greater than 0 for all dimensions - <b>convDesc</b> Group Count Support: Greater than 0. - This algo is not supported if output is of type <code>CUDNN_DATA_HALF</code> and the number of elements in <code>dw</code> is odd.
<code>_ALGO_1</code>	Yes	<code>_NCHW</code> or <code>_NHWC</code>	NCHW CHW- packed	- TRUE_HALF_CONFIG, and - PSEUDO_HALF_CONFIG, and - FLOAT_CONFIG, and - DOUBLE_CONFIG	- <b>Dilation</b> : 1 for all dimensions - <b>convDesc</b> Group Count Support: Greater than 0.
<code>_FFT</code>	Yes	NCHW CHW- packed	NCHW CHW- packed	- PSEUDO_HALF_CONFIG, and - FLOAT_CONFIG	- <b>Dilation</b> : 1 for all dimensions - <b>convDesc</b> Group Count Support: Greater than 0. - <code>xDesc</code> 's feature map height + 2 * <code>convDesc</code> 's zero-padding height

					<p>must equal 256 or less</p> <ul style="list-style-type: none"> <li>- <code>xDesc</code>'s feature map width + 2 * <code>convDesc</code>'s zero-padding width must equal 256 or less</li> <li>- <code>convDesc</code>'s vertical and horizontal filter stride must equal 1</li> <li>- <code>dwDesc</code>'s filter height must be greater than <code>convDesc</code>'s zero-padding height</li> <li>- <code>dwDesc</code>'s filter width must be greater than <code>convDesc</code>'s zero-padding width</li> </ul>
<code>_ALGO_3</code>	Yes	All except <code>_NCHW_VECT_P</code>	NCHW CHW-packed	<ul style="list-style-type: none"> <li>- <code>PSEUDO_HALF_CONFIG</code></li> <li>- <code>FLOAT_CONFIG</code>, and</li> <li>- <code>DOUBLE_CONFIG</code></li> </ul>	<ul style="list-style-type: none"> <li>- <b>Dilation:</b> 1 for all dimensions</li> <li>- <code>convDesc</code> Group Count Support: Greater than 0.</li> </ul>
<code>_WINOGRAD_NONFUSED</code>	Yes	All except <code>_NCHW_VECT_P</code>	NCHW CHW-packed	<ul style="list-style-type: none"> <li>- <code>TRUE_HALF_CONFIG</code></li> <li>- <code>PSEUDO_HALF_CONFIG</code>, and</li> <li>- <code>FLOAT_CONFIG</code></li> </ul>	<ul style="list-style-type: none"> <li>- <b>Dilation:</b> 1 for all dimensions</li> <li>- <code>convDesc</code> Group Count Support: Greater than 0.</li> <li>- <code>convDesc</code>'s vertical and horizontal filter stride must equal 1</li> <li>- <code>wDesc</code>'s filter (height, width) must be (3,3) or (5,5)</li> <li>- If <code>wDesc</code>'s filter (height, width) is (5,5), then the data type config <code>TRUE_HALF_CONFIG</code> is not supported.</li> </ul>
<code>_FFT_TILING</code>	Yes	NCHW CHW-packed	NCHW CHW-packed	<ul style="list-style-type: none"> <li>- <code>PSEUDO_HALF_CONFIG</code></li> </ul>	<ul style="list-style-type: none"> <li>- <b>Dilation:</b> 1 for all dimensions</li> </ul>

				<ul style="list-style-type: none"> <li>- FLOAT_CONFIG, and</li> <li>- DOUBLE_CONFIG</li> </ul>	<ul style="list-style-type: none"> <li>- convDesc Group Count Support: Greater than 0.</li> <li>- xDesc's width or height must equal 1</li> <li>- dyDesc's width or height must equal 1 (the same dimension as in xDesc.) The other dimension must be less than or equal to 256, i.e., the largest 1D tile size currently supported.</li> <li>- convDesc's vertical and horizontal filter stride must equal 1</li> <li>- dwDesc's filter height must be greater than convDesc's zero-padding height.</li> <li>- dwDesc's filter width must be greater than convDesc's zero-padding width.</li> </ul>
--	--	--	--	--	--

**FOR 3D CONVOLUTIONS.**

Filter descriptor wDesc: _NCHW					
Algo Name	Deterministic (Yes or No)	Tensor Formats Supported for xDesc	Tensor Formats Supported for dyDesc	Data Type Configurations Support	Important
_ALGO_0	No	All except _NCDHW-vec	NCDHW-fully-packed	<ul style="list-style-type: none"> <li>- PSEUDO_HALF_CONFIG</li> <li>- FLOAT_CONFIG, and</li> <li>- DOUBLE_CONFIG</li> </ul>	<ul style="list-style-type: none"> <li>- <b>Dilation:</b> greater than 0 for all dimensions</li> <li>- convDesc Group Count Support: Greater than 0.</li> </ul>
_ALGO_3	No	NCDHW-fully-packed	NCDHW-fully-packed	<ul style="list-style-type: none"> <li>- PSEUDO_HALF_CONFIG</li> <li>- FLOAT_CONFIG, and</li> </ul>	<ul style="list-style-type: none"> <li>- <b>Dilation:</b> 1 for all dimensions</li> <li>- convDesc Group Count Support: Greater than 0.</li> </ul>

				-	DOUBLE_CONFIG	
--	--	--	--	---	---------------	--

### Returns

#### CUDNN\_STATUS\_SUCCESS

The operation was launched successfully.

#### CUDNN\_STATUS\_BAD\_PARAM

At least one of the following conditions are met:

- ▶ At least one of the following is NULL: **handle**, **xDesc**, **dyDesc**, **convDesc**, **dwDesc**, **xData**, **dyData**, **dwData**, **alpha**, **beta**
- ▶ **xDesc** and **dyDesc** have a non-matching number of dimensions
- ▶ **xDesc** and **dwDesc** have a non-matching number of dimensions
- ▶ **xDesc** has fewer than three number of dimensions
- ▶ **xDesc**, **dyDesc** and **dwDesc** have a non-matching data type.
- ▶ **xDesc** and **dwDesc** have a non-matching number of input feature maps per image (or group in case of Grouped Convolutions).
- ▶ **yDesc** or **wDesc** indicate an output channel count that isn't a multiple of group count (if group count has been set in convDesc).

#### CUDNN\_STATUS\_NOT\_SUPPORTED

At least one of the following conditions are met:

- ▶ **xDesc** or **dyDesc** have negative tensor striding
- ▶ **xDesc**, **dyDesc** or **dwDesc** has a number of dimensions that is not 4 or 5
- ▶ The chosen algo does not support the parameters provided; see above for exhaustive list of parameter support for each algo

#### CUDNN\_STATUS\_MAPPING\_ERROR

An error occurs during the texture binding of the filter data.

#### CUDNN\_STATUS\_EXECUTION\_FAILED

The function failed to launch on the GPU.

## 4.12. cudnnConvolutionBiasActivationForward

```

cudnnStatus_t cudnnConvolutionBiasActivationForward(
    cudnnHandle_t          handle,
    const void             *alpha1,
    const cudnnTensorDescriptor_t xDesc,
    const void             *x,
    const cudnnFilterDescriptor_t wDesc,
    const void             *w,
    cudnnConvolutionDescriptor_t convDesc,
    cudnnConvolutionFwdAlgo_t algo,
    void                   *workSpace,
    size_t                 workSpaceSizeInBytes,
    const void             *alpha2,
    const cudnnTensorDescriptor_t zDesc,
    const void             *z,
    const cudnnTensorDescriptor_t biasDesc,

```

```

const void          *bias,
const cudnnActivationDescriptor_t activationDesc,
const cudnnTensorDescriptor_t yDesc,
void               *y)

```

This function applies a bias and then an activation to the convolutions or cross-correlations of `cudnnConvolutionForward()`, returning results in **y**. The full computation follows the equation  $\mathbf{y} = \text{act} (\ \alpha_1 * \text{conv}(\mathbf{x}) + \alpha_2 * \mathbf{z} + \text{bias} )$ .



The routine `cudnnGetConvolution2dForwardOutputDim` or `cudnnGetConvolutionNdForwardOutputDim` can be used to determine the proper dimensions of the output tensor descriptor `yDesc` with respect to `xDesc`, `convDesc` and `wDesc`.



Only the `CUDNN_CONVOLUTION_FWD_ALGO_IMPLICIT_PRECOMP_GEMM` algo is enabled with `CUDNN_ACTIVATION_IDENTITY`. In other words, in the `cudnnActivationDescriptor_t` structure of the input `activationDesc`, if the mode of the `cudnnActivationMode_t` field is set to the enum value `CUDNN_ACTIVATION_IDENTITY`, then the input `cudnnConvolutionFwdAlgo_t` of this function `cudnnConvolutionBiasActivationForward()` must be set to the enum value `CUDNN_CONVOLUTION_FWD_ALGO_IMPLICIT_PRECOMP_GEMM`. See also the documentation for the function `cudnnSetActivationDescriptor()`.

## Parameters

### handle

*Input.* Handle to a previously created cuDNN context. See [cudnnHandle\\_t](#).

### alpha1, alpha2

*Input.* Pointers to scaling factors (in host memory) used to blend the computation result with prior value in the output layer as described by the above equation. [Please refer to this section for additional details.](#)

### xDesc

*Input.* Handle to a previously initialized tensor descriptor. See [cudnnTensorDescriptor\\_t](#).

### x

*Input.* Data pointer to GPU memory associated with the tensor descriptor `xDesc`.

### wDesc

*Input.* Handle to a previously initialized filter descriptor. See [cudnnFilterDescriptor\\_t](#).

### w

*Input.* Data pointer to GPU memory associated with the filter descriptor `wDesc`.

### convDesc

*Input.* Previously initialized convolution descriptor. See [cudnnConvolutionDescriptor\\_t](#).

**algo**

*Input.* Enumerant that specifies which convolution algorithm should be used to compute the results. See [cudnnConvolutionFwdAlgo\\_t](#).

**workSpace**

*Input.* Data pointer to GPU memory to a workspace needed to able to execute the specified algorithm. If no workspace is needed for a particular algorithm, that pointer can be nil.

**workSpaceSizeInBytes**

*Input.* Specifies the size in bytes of the provided **workSpace**.

**zDesc**

*Input.* Handle to a previously initialized tensor descriptor.

**z**

*Input.* Data pointer to GPU memory associated with the tensor descriptor **zDesc**.

**biasDesc**

*Input.* Handle to a previously initialized tensor descriptor.

**bias**

*Input.* Data pointer to GPU memory associated with the tensor descriptor **biasDesc**.

**activationDesc**

*Input.* Handle to a previously initialized activation descriptor. See [cudnnActivationDescriptor\\_t](#).

**yDesc**

*Input.* Handle to a previously initialized tensor descriptor.

**y**

*Input/Output.* Data pointer to GPU memory associated with the tensor descriptor **yDesc** that carries the result of the convolution.

For the convolution step, this function supports the specific combinations of data types for **xDesc**, **wDesc**, **convDesc** and **yDesc** as listed in the documentation of `cudnnConvolutionForward()`. The following table specifies the supported combinations of data types for **x**, **y**, **z**, **bias**, and **alpha1/alpha2**.

Table Key: X = CUDNN\_DATA

<b>x</b>	<b>w</b>	<b>y and z</b>	<b>bias</b>	<b>alpha1/alpha2</b>
X_DOUBLE	X_DOUBLE	X_DOUBLE	X_DOUBLE	X_DOUBLE
X_FLOAT	X_FLOAT	X_FLOAT	X_FLOAT	X_FLOAT
X_HALF	X_HALF	X_HALF	X_HALF	X_FLOAT
X_INT8	X_INT8	X_INT8	X_FLOAT	X_FLOAT
X_INT8	X_INT8	X_FLOAT	X_FLOAT	X_FLOAT
X_INT8x4	X_INT8x4	X_INT8x4	X_FLOAT	X_FLOAT

x	w	y and z	bias	alpha1/alpha2
X_INT8x4	X_INT8x4	X_FLOAT	X_FLOAT	X_FLOAT
X_UINT8	X_INT8	X_INT8	X_FLOAT	X_FLOAT
X_UINT8	X_INT8	X_FLOAT	X_FLOAT	X_FLOAT
X_UINT8x4	X_INT8x4	X_INT8x4	X_FLOAT	X_FLOAT
X_UINT8x4	X_INT8x4	X_FLOAT	X_FLOAT	X_FLOAT

In addition to the error values listed by the documentation of `cudaConvolutionForward()`, the possible error values returned by this function and their meanings are listed below.

### Returns

#### **CUDNN\_STATUS\_SUCCESS**

The operation was launched successfully.

#### **CUDNN\_STATUS\_BAD\_PARAM**

At least one of the following conditions are met:

- ▶ At least one of the following is NULL: **zDesc**, **zData**, **biasDesc**, **bias**, **activationDesc**.
- ▶ The second dimension of **biasDesc** and the first dimension of **filterDesc** are not equal.
- ▶ **zDesc** and **destDesc** do not match.

#### **CUDNN\_STATUS\_NOT\_SUPPORTED**

The function does not support the provided configuration. See the following for some examples of non-supported configurations:

- ▶ The **mode** of **activationDesc** is neither **CUDNN\_ACTIVATION\_RELU** or **CUDNN\_ACTIVATION\_IDENTITY**.
- ▶ The **reluNanOpt** of **activationDesc** is not **CUDNN\_NOT\_PROPAGATE\_NAN**.
- ▶ The second stride of **biasDesc** is not equal to one.
- ▶ The data type of **biasDesc** does not correspond to the data type of **yDesc** as listed in the above data types table.

#### **CUDNN\_STATUS\_EXECUTION\_FAILED**

The function failed to launch on the GPU.

## 4.13. `cudaConvolutionForward`

```

cudaStatus_t cudaConvolutionForward(
    cudaHandle_t          handle,
    const void            *alpha,
    const cudaTensorDescriptor_t xDesc,
    const void            *x,
    const cudaFilterDescriptor_t wDesc,
    const void            *w,
    const cudaConvolutionDescriptor_t convDesc,
    cudaConvolutionFwdAlgo_t algo,
    void                  *workSpace,

```

```

size_t                workspaceSizeInBytes,
const void            *beta,
const cudnnTensorDescriptor_t yDesc,
void                 *y)

```

This function executes convolutions or cross-correlations over **x** using filters specified with **w**, returning results in **y**. Scaling factors **alpha** and **beta** can be used to scale the input tensor and the output tensor respectively.



The routine `cudnnGetConvolution2dForwardOutputDim` or `cudnnGetConvolutionNdForwardOutputDim` can be used to determine the proper dimensions of the output tensor descriptor `yDesc` with respect to `xDesc`, `convDesc` and `wDesc`.

## Parameters

### **handle**

*Input.* Handle to a previously created cuDNN context. See [cudnnHandle\\_t](#).

### **alpha, beta**

*Input.* Pointers to scaling factors (in host memory) used to blend the computation result with prior value in the output layer as follows:  $\text{dstValue} = \text{alpha}[0] * \text{result} + \text{beta}[0] * \text{priorDstValue}$ . Refer to this section for additional details.

### **xDesc**

*Input.* Handle to a previously initialized tensor descriptor. See [cudnnTensorDescriptor\\_t](#).

### **x**

*Input.* Data pointer to GPU memory associated with the tensor descriptor `xDesc`.

### **wDesc**

*Input.* Handle to a previously initialized filter descriptor. See [cudnnFilterDescriptor\\_t](#).

### **w**

*Input.* Data pointer to GPU memory associated with the filter descriptor `wDesc`.

### **convDesc**

*Input.* Previously initialized convolution descriptor. See [cudnnConvolutionDescriptor\\_t](#).

### **algo**

*Input.* Enumerant that specifies which convolution algorithm should be used to compute the results. See [cudnnConvolutionFwdAlgo\\_t](#).

### **workspace**

*Input.* Data pointer to GPU memory to a workspace needed to able to execute the specified algorithm. If no workspace is needed for a particular algorithm, that pointer can be nil.

### **workspaceSizeInBytes**

*Input.* Specifies the size in bytes of the provided `workspace`.



**yDesc**

*Input.* Handle to a previously initialized tensor descriptor.

**y**

*Input/Output.* Data pointer to GPU memory associated with the tensor descriptor **yDesc** that carries the result of the convolution.

**TABLE OF THE SUPPORTED CONFIGURATIONS**

This function supports the following combinations of data types for **xDesc**, **wDesc**, **convDesc**, and **yDesc**. See the following table for a list of the supported configurations.

Data Type Configurations	xDesc and wDesc	convDesc	yDesc
TRUE_HALF_CONFIG (only supported on architectures with true fp16 support, i.e., compute capability 5.3 and later).	CUDNN_DATA_HALF	CUDNN_DATA_HALF	CUDNN_DATA_HALF
PSEUDO_HALF_CONFIG	CUDNN_DATA_HALF	CUDNN_DATA_FLOAT	CUDNN_DATA_HALF
FLOAT_CONFIG	CUDNN_DATA_FLOAT	CUDNN_DATA_FLOAT	CUDNN_DATA_FLOAT
DOUBLE_CONFIG	CUDNN_DATA_DOUBLE	CUDNN_DATA_DOUBLE	CUDNN_DATA_DOUBLE
INT8_CONFIG (only supported on architectures with DP4A support, i.e., compute capability 6.1 and later).	CUDNN_DATA_INT8	CUDNN_DATA_INT32	CUDNN_DATA_INT8
INT8_EXT_CONFIG (only supported on architectures with DP4A support, i.e., compute capability 6.1 and later).	CUDNN_DATA_INT8	CUDNN_DATA_INT32	CUDNN_DATA_FLOAT
INT8x4_CONFIG (only supported on architectures with DP4A support, i.e., compute capability 6.1 and later).	CUDNN_DATA_INT8x4	CUDNN_DATA_INT32	CUDNN_DATA_INT8x4
INT8x4_EXT_CONFIG (only supported on architectures with DP4A support, i.e., compute capability 6.1 and later).	CUDNN_DATA_INT8x4	CUDNN_DATA_INT32	CUDNN_DATA_FLOAT
UINT8x4_CONFIG (new for 7.1) (only supported on architectures with	CUDNN_DATA_UINT8x4	CUDNN_DATA_INT32	CUDNN_DATA_UINT8x4

Data Type Configurations	xDesc and wDesc	convDesc	yDesc
DP4A support, i.e., compute capability 6.1 and later).			
UINT8x4_EXT_CONFIG (new for 7.1) (only supported on architectures with DP4A support, i.e., compute capability 6.1 and later).	CUDNN_DATA_UINT8x4	CUDNN_DATA_INT32	CUDNN_DATA_FLOAT

 For this function, all algorithms perform deterministic computations. Specifying a separate algorithm can cause changes in performance and support.

### TABLE OF THE SUPPORTED ALGORITHMS

The table below shows the list of the supported 2D and 3D convolutions. The 2D convolutions are described first, followed by the 3D convolutions.

For the following terms, the short-form versions shown in the paranthesis are used in the table below, for brevity:

- ▶ CUDNN\_CONVOLUTION\_FWD\_ALGO\_IMPLICIT\_GEMM (**\_IMPLICIT\_GEMM**)
- ▶ CUDNN\_CONVOLUTION\_FWD\_ALGO\_IMPLICIT\_PRECOMP\_GEMM (**\_IMPLICIT\_PRECOMP\_GEMM**)
- ▶ CUDNN\_CONVOLUTION\_FWD\_ALGO\_GEMM (**\_GEMM**)
- ▶ CUDNN\_CONVOLUTION\_FWD\_ALGO\_DIRECT (**\_DIRECT**)
- ▶ CUDNN\_CONVOLUTION\_FWD\_ALGO\_FFT (**\_FFT**)
- ▶ CUDNN\_CONVOLUTION\_FWD\_ALGO\_FFT\_TILING (**\_FFT\_TILING**)
- ▶ CUDNN\_CONVOLUTION\_FWD\_ALGO\_WINOGRAD (**\_WINOGRAD**)
- ▶ CUDNN\_CONVOLUTION\_FWD\_ALGO\_WINOGRAD\_NONFUSED (**\_WINOGRAD\_NONFUSED**)
- ▶ CUDNN\_TENSOR\_NCHW (**\_NCHW**)
- ▶ CUDNN\_TENSOR\_NHWC (**\_NHWC**)
- ▶ CUDNN\_TENSOR\_NCHW\_VECT\_C (**\_NCHW\_VECT\_C**)

### FOR 2D CONVOLUTIONS.

Filter descriptor wDesc: <b>_NCHW</b> . See <a href="#">cudnnTensorFormat_t</a> .				
convDesc Group count support: Greater than 0, for all algos.				
Algo Name (see below for 3D Convolutions)	Tensor Formats Supported for xDesc	Tensor Formats Supported for yDesc	Data Type Configurations Supported	Important
<b>_IMPLICIT_GEMM</b>	All except <b>_NCHW_VECT_C</b> .	All except <b>_NCHW_VECT_C</b> .	- PSEUDO_HALF_CONFIG	<b>Dilation:</b> Greater than 0 for all dimensions.

			- FLOAT_CONFIG, and - DOUBLE_CONFIG	
<b>_IMPLICIT_PRECOMP_GEMM</b>			- TRUE_HALF_CONFIG, - PSEUDO_HALF_CONFIG, - FLOAT_CONFIG, and - DOUBLE_CONFIG.	<b>Dilation:</b> 1 for all dimensions.
<b>_GEMM</b>			- PSEUDO_HALF_CONFIG, - FLOAT_CONFIG, and - DOUBLE_CONFIG	<b>Dilation:</b> 1 for all dimensions.
<b>_FFT</b>	NCHW HW-packed	NCHW HW-packed	- PSEUDO_HALF_CONFIG and - FLOAT_CONFIG	<b>Dilation:</b> 1 for all dimensions. - xDesc's feature map <b>height</b> + 2 * convDesc's zero-padding height must equal 256 or less - xDesc's feature map <b>width</b> + 2 * convDesc's zero-padding width must equal 256 or less - convDesc's vertical and horizontal filter stride must equal 1 - wDesc's filter height must be greater than convDesc's zero-padding <b>height</b> - wDesc's filter width must be greater than convDesc's zero-padding <b>width</b>
<b>_FFT_TILING</b>			- PSEUDO_HALF_CONFIG and - FLOAT_CONFIG DOUBLE_CONFIG is also supported when the task can be handled by 1D FFT, i.e., one of the filter dimension, width or height is 1.	<b>Dilation:</b> 1 for all dimensions. - When <b>neither</b> of wDesc's filter dimension is 1, the filter width and height must not be larger than 32 - When <b>either</b> of wDesc's filter dimension is 1, the largest filter dimension should not exceed 256

				<ul style="list-style-type: none"> <li>- convDesc's vertical and horizontal filter stride must equal 1 when either the filter width or filter height is 1, otherwise the stride can be 1 or 2</li> <li>- wDesc's filter height must be greater than convDesc's zero-padding height</li> <li>- wDesc's filter width must be greater than convDesc's zero-padding width</li> </ul>
<b>_WINOGRAD</b>	All except: <b>_NCHW_VECT_C</b>	All except: <b>C_NCHW_VECT_C</b>	<ul style="list-style-type: none"> <li>- PSEUDO_HALF_CONFIG and</li> <li>- FLOAT_CONFIG</li> </ul>	<p><b>Dilation:</b> 1 for all dimensions.</p> <ul style="list-style-type: none"> <li>- convDesc's vertical and horizontal filter stride must equal 1</li> <li>- wDesc's filter height must be 3</li> <li>- wDesc's filter width must be 3</li> </ul>
<b>_WINOGRAD_NONFUSED</b>			<ul style="list-style-type: none"> <li>- TRUE_HALF_CONFIG,</li> <li>- PSEUDO_HALF_CONFIG and</li> <li>- FLOAT_CONFIG</li> </ul>	<p><b>Dilation:</b> 1 for all dimensions.</p> <ul style="list-style-type: none"> <li>- convDesc's vertical and horizontal filter stride must equal 1</li> <li>- wDesc's filter (height, width) must be (3,3) or (5,5)</li> <li>- If wDesc's filter (height, width) is (5,5), then data type config TRUE_HALF_CONFIG is not supported</li> </ul>
<b>_DIRECT</b>	Currently not implemented in cuDNN.			
<p><b>Filter descriptor wDesc:</b> <b>_NHWC</b></p> <p>convDesc Group count support: Greater than 0.</p>				
<b>Algo Name</b>	<b>xDesc</b>	<b>yDesc</b>	<b>Data Type Configurations Support</b>	<b>Important</b>
<b>_IMPLICIT_GEMM</b>	NCHWC HWC-packed	NCHWC HWC-packed	<ul style="list-style-type: none"> <li>- PSEUDO_HALF_CONFIG and</li> <li>- FLOAT_CONFIG</li> </ul>	<p><b>Dilation:</b> Greater than 1 for all dimensions.</p>

Filter descriptor <code>wDesc</code> : <code>_NHWC</code> <code>convDesc</code> Group count support: Greater than 0.				
Algo Name	<code>xDesc</code>	<code>yDesc</code>	Data Type Configurations Support	Important
<code>_IMPLICIT_PRECOMP_GEMM</code>	<code>NHWC</code>	<code>NHWC</code>	- <code>INT8_CONFIG</code> , - <code>INT8_EXT_CONFIG</code> , - <code>INT8x4_CONFIG</code> , - <code>INT8x4_EXT_CONFIG</code> , - <code>UINT8x4_CONFIG</code> , and - <code>UINT8x4_EXT_CONFIG</code>	<b>Dilation:</b> 1 for all dimensions. Input and output features maps must be multiple of 4.

**FOR 3D CONVOLUTIONS.**

Filter descriptor <code>wDesc</code> : <code>_NCHW</code> <code>convDesc</code> Group count support: Greater than 0, for all algos.				
Algo Name	<code>xDesc</code>	<code>yDesc</code>	Data Type Configurations Support	Important
<code>_IMPLICIT_GEMM</code>	All except <code>_NCHW_VECT_C</code>	All except <code>_NCHW_VECT_C</code>	- <code>PSEUDO_HALF_CONFIG</code>	<b>Dilation:</b> Greater than 1 for all dimensions.
<code>_IMPLICIT_PRECOMP_GEMM</code>			- <code>FLOAT_CONFIG</code> , and - <code>DOUBLE_CONFIG</code> .	<b>Dilation:</b> 1 for all dimensions.
<code>_FFT_TILING</code>	<code>NCDHW DHW-packed</code>	<code>NCDHW DHW-packed</code>	- <code>PSEUDO_HALF_CONFIG</code> , - <code>FLOAT_CONFIG</code> , and - <code>DOUBLE_CONFIG</code> .	<b>Dilation:</b> 1 for all dimensions. - <code>wDesc</code> 's filter height must equal 16 or less - <code>wDesc</code> 's filter width must equal 16 or less - <code>wDesc</code> 's filter depth must equal 16 or less - <code>convDesc</code> 's must have all filter strides equal to 1 - <code>wDesc</code> 's filter height must be greater than <code>convDesc</code> 's zero-padding height - <code>wDesc</code> 's filter width must be greater than <code>convDesc</code> 's zero-padding width

				- <b>wDesc</b> 's filter depth must be greater than <b>convDesc</b> 's zero-padding width
--	--	--	--	---



Tensors can be converted to, and from, CUDNN\_TENSOR\_NCHW\_VECT\_C with `cudaTransformTensor()`.

### Returns

#### CUDNN\_STATUS\_SUCCESS

The operation was launched successfully.

#### CUDNN\_STATUS\_BAD\_PARAM

At least one of the following conditions are met:

- ▶ At least one of the following is NULL: **handle**, **xDesc**, **wDesc**, **convDesc**, **yDesc**, **xData**, **w**, **yData**, **alpha**, **beta**
- ▶ **xDesc** and **yDesc** have a non-matching number of dimensions
- ▶ **xDesc** and **wDesc** have a non-matching number of dimensions
- ▶ **xDesc** has fewer than three number of dimensions
- ▶ **xDesc**'s number of dimensions is not equal to **convDesc**'s array length + 2
- ▶ **xDesc** and **wDesc** have a non-matching number of input feature maps per image (or group in case of Grouped Convolutions)
- ▶ **yDesc** or **wDesc** indicate an output channel count that isn't a multiple of group count (if group count has been set in **convDesc**).
- ▶ **xDesc**, **wDesc** and **yDesc** have a non-matching data type
- ▶ For some spatial dimension, **wDesc** has a spatial size that is larger than the input spatial size (including zero-padding size)

#### CUDNN\_STATUS\_NOT\_SUPPORTED

At least one of the following conditions are met:

- ▶ **xDesc** or **yDesc** have negative tensor striding
- ▶ **xDesc**, **wDesc** or **yDesc** has a number of dimensions that is not 4 or 5
- ▶ **yDesc**'s spatial sizes do not match with the expected size as determined by `cudaGetConvolutionNdForwardOutputDim`
- ▶ The chosen algo does not support the parameters provided; see above for exhaustive list of parameter support for each algo

#### CUDNN\_STATUS\_MAPPING\_ERROR

An error occurred during the texture binding of the filter data.

#### CUDNN\_STATUS\_EXECUTION\_FAILED

The function failed to launch on the GPU.

## 4.14. cudnnCreate

```
cudaStatus_t cudnnCreate(cudaHandle_t *handle)
```

This function initializes the cuDNN library and creates a handle to an opaque structure holding the cuDNN library context. It allocates hardware resources on the host and device and must be called prior to making any other cuDNN library calls.

The cuDNN library handle is tied to the current CUDA device (context). To use the library on multiple devices, one cuDNN handle needs to be created for each device.

For a given device, multiple cuDNN handles with different configurations (e.g., different current CUDA streams) may be created. Because `cudaDnnCreate` allocates some internal resources, the release of those resources by calling `cudaDnnDestroy` will implicitly call `cudaDeviceSynchronize`; therefore, the recommended best practice is to call `cudaDnnCreate/cudaDnnDestroy` outside of performance-critical code paths.

For multithreaded applications that use the same device from different threads, the recommended programming model is to create one (or a few, as is convenient) cuDNN handle(s) per thread and use that cuDNN handle for the entire life of the thread.

### Parameters

#### handle

*Output.* Pointer to pointer where to store the address to the allocated cuDNN handle. See `cudaDnnHandle_t`.

### Returns

#### CUDNN\_STATUS\_BAD\_PARAM

Invalid (NULL) input pointer supplied.

#### CUDNN\_STATUS\_NOT\_INITIALIZED

No compatible GPU found, CUDA driver not installed or disabled, CUDA runtime API initialization failed.

#### CUDNN\_STATUS\_ARCH\_MISMATCH

NVIDIA GPU architecture is too old.

#### CUDNN\_STATUS\_ALLOC\_FAILED

Host memory allocation failed.

#### CUDNN\_STATUS\_INTERNAL\_ERROR

CUDA resource allocation failed.

#### CUDNN\_STATUS\_LICENSE\_ERROR

cuDNN license validation failed (only when the feature is enabled).

#### CUDNN\_STATUS\_SUCCESS

cuDNN handle was created successfully.

## 4.15. cudaDnnCreateActivationDescriptor

```
cudaDnnStatus_t cudaDnnCreateActivationDescriptor(
    cudaDnnActivationDescriptor_t *activationDesc)
```

This function creates a activation descriptor object by allocating the memory needed to hold its opaque structure. See [cudnnActivationDescriptor\\_t](#).

#### Returns

##### **CUDNN\_STATUS\_SUCCESS**

The object was created successfully.

##### **CUDNN\_STATUS\_ALLOC\_FAILED**

The resources could not be allocated.

## 4.16. cudnnCreateAlgorithmDescriptor

```
cudnnStatus_t cudnnCreateAlgorithmDescriptor(
    cudnnAlgorithmDescriptor_t *algoDesc)
```

#### (New for 7.1)

This function creates an algorithm descriptor object by allocating the memory needed to hold its opaque structure.

#### Returns

##### **CUDNN\_STATUS\_SUCCESS**

The object was created successfully.

##### **CUDNN\_STATUS\_ALLOC\_FAILED**

The resources could not be allocated.

## 4.17. cudnnCreateAlgorithmPerformance

```
cudnnStatus_t cudnnCreateAlgorithmPerformance(
    cudnnAlgorithmPerformance_t *algoPerf,
    int numberToCreate)
```

#### (New for 7.1)

This function creates multiple algorithm performance objects by allocating the memory needed to hold their opaque structures.

#### Returns

##### **CUDNN\_STATUS\_SUCCESS**

The object was created successfully.

##### **CUDNN\_STATUS\_ALLOC\_FAILED**

The resources could not be allocated.

## 4.18. cudnnCreateAttnDescriptor

```
cudnnStatus_t cudnnCreateAttnDescriptor(cudnnAttnDescriptor_t *attnDesc);
```



This function creates an attention descriptor object by allocating the memory needed to hold its structure. Use the [cudnnSetAttnDescriptor](#) function to initialize the descriptor, and the [cudnnDestroyAttnDescriptor](#) function to destroy the descriptor.

**Parameters:**

Parameter	Input / Output	Description
attnDesc	Output	An uninitialized attention descriptor.

**Returns:**

Return Value	Description
CUDNN_STATUS_SUCCESS	The descriptor object is created successfully.
CUDNN_STATUS_BAD_PARAM	The <code>attnDesc</code> is NULL.
CUDNN_STATUS_ALLOC_FAILED	The memory allocation failed.

## 4.19. cudnnCreateConvolutionDescriptor

```
cudnnStatus_t cudnnCreateConvolutionDescriptor(
    cudnnConvolutionDescriptor_t *convDesc)
```

This function creates a convolution descriptor object by allocating the memory needed to hold its opaque structure. See [cudnnConvolutionDescriptor\\_t](#).

**Returns**

**CUDNN\_STATUS\_SUCCESS**

The object was created successfully.

**CUDNN\_STATUS\_ALLOC\_FAILED**

The resources could not be allocated.

## 4.20. cudnnCreateCTCLossDescriptor

```
cudnnStatus_t cudnnCreateCTCLossDescriptor(
    cudnnCTCLossDescriptor_t* ctcLossDesc)
```

This function creates a CTC loss function descriptor. .

**Parameters**

**ctcLossDesc**

*Output.* CTC loss descriptor to be set. See [cudnnCTCLossDescriptor\\_t](#).

**Returns**

**CUDNN\_STATUS\_SUCCESS**

The function returned successfully.

**CUDNN\_STATUS\_BAD\_PARAM**

CTC loss descriptor passed to the function is invalid.

**CUDNN\_STATUS\_ALLOC\_FAILED**

Memory allocation for this CTC loss descriptor failed.

## 4.21. cudnnCreateDropoutDescriptor

```

cudnnStatus_t cudnnCreateDropoutDescriptor(
    cudnnDropoutDescriptor_t *dropoutDesc)

```

This function creates a generic dropout descriptor object by allocating the memory needed to hold its opaque structure. See [cudnnDropoutDescriptor\\_t](#).

**Returns****CUDNN\_STATUS\_SUCCESS**

The object was created successfully.

**CUDNN\_STATUS\_ALLOC\_FAILED**

The resources could not be allocated.

## 4.22. cudnnCreateFilterDescriptor

```

cudnnStatus_t cudnnCreateFilterDescriptor(
    cudnnFilterDescriptor_t *filterDesc)

```

This function creates a filter descriptor object by allocating the memory needed to hold its opaque structure. See [cudnnFilterDescriptor\\_t](#).

**Returns****CUDNN\_STATUS\_SUCCESS**

The object was created successfully.

**CUDNN\_STATUS\_ALLOC\_FAILED**

The resources could not be allocated.

## 4.23. cudnnCreateFusedOpsConstParamPack

```

cudnnStatus_t cudnnCreateFusedOpsConstParamPack(
    cudnnFusedOpsConstParamPack_t *constPack,
    cudnnFusedOps_t ops);

```

This function creates an opaque structure to store the various problem size information, such as the shape, layout and the type of Tensors, and the descriptors for convolution and activation, for the selected sequence of `cudnnFusedOps` computations.

**Parameters:**

Parameter	Input / Output	Description
<code>constPack</code>	Input	The opaque structure that is created by this function. See <a href="#">cudnnFusedOpsConstParamPack_t</a>

ops	Input	The specific sequence of computations to perform in the cudnnFusedOps computations, as defined in the enumerated type <a href="#">cudnnFusedOps_t</a> .
-----	-------	---

**Returns:**

Return Value	Description
CUDNN_STATUS_BAD_PARAM	If either <code>constPack</code> or <code>ops</code> is NULL.
CUDNN_STATUS_SUCCESS	If the descriptor is created successfully.
CUDNN_STATUS_NOT_SUPPORTED	If the <code>ops</code> enum value is not supported or reserved for future use.

## 4.24. cudnnCreateFusedOpsPlan

```

cudnnStatus_t cudnnCreateFusedOpsPlan(
    cudnnFusedOpsPlan_t *plan,
    cudnnFusedOps_t ops);

```

This function creates the plan descriptor for the cudnnFusedOps computation. This descriptor contains the plan information, including the problem type and size, which kernels should be run, and the internal workspace partition.

**Parameters:**

Parameter	Input / Output	Description
plan	Input	A pointer to the instance of the descriptor created by this function.
ops	Input	The specific sequence of fused operations computations for which this plan descriptor should be created. See <a href="#">cudnnFusedOps_t</a> .

**Returns:**

Return Value	Description
CUDNN_STATUS_BAD_PARAM	If either the input <code>*plan</code> is NULL, or the <code>ops</code> input is not a valid <code>cudnnFusedOp</code> enum.
CUDNN_STATUS_NOT_SUPPORTED	The <code>ops</code> input provided is not supported.
CUDNN_STATUS_SUCCESS	The plan descriptor is created successfully.

## 4.25. cudnnCreateFusedOpsVariantParamPack

```

cudnnStatus_t cudnnCreateFusedOpsVariantParamPack(
    cudnnFusedOpsVariantParamPack_t *varPack,
    cudnnFusedOps_t ops);

```

This function creates a descriptor for cudnnFusedOps constant parameters.

**Parameters:**

Parameter	Input / Output	Description
varPack	Input	Pointer to the descriptor created by this function. See <a href="#">cudnnFusedOpsVariantParamPack_t</a>
ops	Input	The specific sequence of fused operations computations for which this descriptor should be created.

**Returns:**

Return Value	Description
CUDNN_STATUS_SUCCESS	The descriptor is successfully created.
CUDNN_STATUS_BAD_PARAM	If any input is invalid.

## 4.26. cudnnCreateLRNDescriptor

```

cudnnStatus_t cudnnCreateLRNDescriptor(
    cudnnLRNDescriptor_t *poolingDesc)

```

This function allocates the memory needed to hold the data needed for LRN and DivisiveNormalization layers operation and returns a descriptor used with subsequent layer forward and backward calls.

**Returns****CUDNN\_STATUS\_SUCCESS**

The object was created successfully.

**CUDNN\_STATUS\_ALLOC\_FAILED**

The resources could not be allocated.

## 4.27. cudnnCreateOpTensorDescriptor

```

cudnnStatus_t cudnnCreateOpTensorDescriptor(
    cudnnOpTensorDescriptor_t* opTensorDesc)

```

This function creates a Tensor Pointwise math descriptor. See [cudnnOpTensorDescriptor\\_t](#).

**Parameters****opTensorDesc**

*Output.* Pointer to the structure holding the description of the Tensor Pointwise math such as Add, Multiply, and more.

**Returns****CUDNN\_STATUS\_SUCCESS**

The function returned successfully.

**CUDNN\_STATUS\_BAD\_PARAM**

Tensor Pointwise math descriptor passed to the function is invalid.

**CUDNN\_STATUS\_ALLOC\_FAILED**

Memory allocation for this Tensor Pointwise math descriptor failed.

## 4.28. cudnnCreatePersistentRNNPlan

```

cudnnStatus_t cudnnCreatePersistentRNNPlan(
    cudnnRNNDescriptor_t      rnnDesc,
    const int                 minibatch,
    const cudnnDataType_t     dataType,
    cudnnPersistentRNNPlan_t *plan)

```

This function creates a plan to execute persistent RNNs when using the **CUDNN\_RNN\_ALGO\_PERSIST\_DYNAMIC** algo. This plan is tailored to the current GPU and problem hyperparameters. This function call is expected to be expensive in terms of runtime, and should be used infrequently. See [cudnnRNNDescriptor\\_t](#), [cudnnDataType\\_t](#), and [cudnnPersistentRNNPlan\\_t](#).

**Returns****CUDNN\_STATUS\_SUCCESS**

The object was created successfully.

**CUDNN\_STATUS\_ALLOC\_FAILED**

The resources could not be allocated.

**CUDNN\_STATUS\_RUNTIME\_PREREQUISITE\_MISSING**

A prerequisite runtime library cannot be found.

**CUDNN\_STATUS\_NOT\_SUPPORTED**

The current hyperparameters are invalid.

## 4.29. cudnnCreatePoolingDescriptor

```

cudnnStatus_t cudnnCreatePoolingDescriptor(
    cudnnPoolingDescriptor_t *poolingDesc)

```

This function creates a pooling descriptor object by allocating the memory needed to hold its opaque structure,

**Returns****CUDNN\_STATUS\_SUCCESS**

The object was created successfully.

**CUDNN\_STATUS\_ALLOC\_FAILED**

The resources could not be allocated.

## 4.30. cudnnCreateReduceTensorDescriptor

```

cudnnStatus_t cudnnCreateReduceTensorDescriptor(
    cudnnReduceTensorDescriptor_t* reduceTensorDesc)

```

This function creates a reduce tensor descriptor object by allocating the memory needed to hold its opaque structure.

### Parameters

None.

### Returns

**CUDNN\_STATUS\_SUCCESS**

The object was created successfully.

**CUDNN\_STATUS\_BAD\_PARAM**

reduceTensorDesc is a NULL pointer.

**CUDNN\_STATUS\_ALLOC\_FAILED**

The resources could not be allocated.

## 4.31. cudnnCreateRNNDataDescriptor

```

cudnnStatus_t cudnnCreateRNNDataDescriptor(
    cudnnRNNDataDescriptor_t *RNNDataDesc)

```

This function creates a RNN data descriptor object by allocating the memory needed to hold its opaque structure.

### Returns

**CUDNN\_STATUS\_SUCCESS**

The RNN data descriptor object was created successfully.

**CUDNN\_STATUS\_BAD\_PARAM**

RNNDataDesc is NULL.

**CUDNN\_STATUS\_ALLOC\_FAILED**

The resources could not be allocated.

## 4.32. cudnnCreateRNNDescriptor

```

cudnnStatus_t cudnnCreateRNNDescriptor(
    cudnnRNNDescriptor_t *rnnDesc)

```

This function creates a generic RNN descriptor object by allocating the memory needed to hold its opaque structure.

**Returns****CUDNN\_STATUS\_SUCCESS**

The object was created successfully.

**CUDNN\_STATUS\_ALLOC\_FAILED**

The resources could not be allocated.

## 4.33. cudnnCreateSeqDataDescriptor

```

cudnnStatus_t cudnnCreateSeqDataDescriptor(cudnnSeqDataDescriptor_t
*seqDataDesc);

```

This function creates a sequence data descriptor object by allocating the memory needed to hold its opaque structure. The sequence data is initialized to be all zero. Use the [cudnnSetSeqDataDescriptor](#) function to initialize the descriptor created by this function.

**Parameters:**

Parameter	Input / Output	Description
seqDataDesc	Output	A sequence data descriptor whose sequence data is initialized to be all zero.

**Returns:**

Return Value	Description
CUDNN_STATUS_SUCCESS	The descriptor object was created successfully.
CUDNN_STATUS_BAD_PARAM	The <code>seqDataDesc</code> is NULL.
CUDNN_STATUS_ALLOC_FAILED	The memory allocation failed.

## 4.34. cudnnCreateSpatialTransformerDescriptor

```

cudnnStatus_t cudnnCreateSpatialTransformerDescriptor(
cudnnSpatialTransformerDescriptor_t *stDesc)

```

This function creates a generic spatial transformer descriptor object by allocating the memory needed to hold its opaque structure.

**Returns****CUDNN\_STATUS\_SUCCESS**

The object was created successfully.

**CUDNN\_STATUS\_ALLOC\_FAILED**

The resources could not be allocated.

## 4.35. cudnnCreateTensorDescriptor

```

cudnnStatus_t cudnnCreateTensorDescriptor(

```

```
cudaError_t cudnnTensorDescriptor_t *tensorDesc)
```

This function creates a generic tensor descriptor object by allocating the memory needed to hold its opaque structure. The data is initialized to be all zero.

### Parameters

#### tensorDesc

*Input.* Pointer to pointer where the address to the allocated tensor descriptor object should be stored.

### Returns

**CUDNN\_STATUS\_BAD\_PARAM**

Invalid input argument.

**CUDNN\_STATUS\_ALLOC\_FAILED**

The resources could not be allocated.

**CUDNN\_STATUS\_SUCCESS**

The object was created successfully.

## 4.36. cudnnCreateTensorTransformDescriptor

```
cudaError_t cudnnCreateTensorTransformDescriptor(
    cudaError_t *transformDesc);
```

This function creates a Tensor transform descriptor object by allocating the memory needed to hold its opaque structure. The Tensor data is initialized to be all zero. Use the [cudnnSetTensorTransformDescriptor](#) function to initialize the descriptor created by this function.

### Parameters:

Parameter	Input / Output	Description
transformDesc	Output	A pointer to an uninitialized Tensor transform descriptor.

### Returns:

Return Value	Description
CUDNN_STATUS_SUCCESS	The descriptor object was created successfully.
CUDNN_STATUS_BAD_PARAM	The <code>transformDesc</code> is NULL.
CUDNN_STATUS_ALLOC_FAILED	The memory allocation failed.

## 4.37. cudnnCTCLoss

```
cudaError_t cudnnCTCLoss(
    cudaError_t handle,
    const cudaError_t *tensorDesc,
    const void *probsDesc,
    const void *probs,
```



```

const int *labels,
const int *labelLengths,
const int *inputLengths,
void *costs,
const cudnnTensorDescriptor_t gradientsDesc,
const void *gradients,
cudnnCTCLossAlgo_t algo,
const cudnnCTCLossDescriptor_t ctcLossDesc,
void *workspace,
size_t workspaceSizeInBytes)

```

This function returns the ctc costs and gradients, given the probabilities and labels.



This function has an inconsistent interface, i.e., the `probs` input is probability normalized by softmax, but the `gradients` output is with respect to the unnormalized activation.

## Parameters

### handle

*Input.* Handle to a previously created cuDNN context. See [cudnnHandle\\_t](#).

### probsDesc

*Input.* Handle to the previously initialized probabilities tensor descriptor. See [cudnnTensorDescriptor\\_t](#).

### probs

*Input.* Pointer to a previously initialized probabilities tensor. These input probabilities are normalized by softmax.

### labels

*Input.* Pointer to a previously initialized labels list.

### labelLengths

*Input.* Pointer to a previously initialized lengths list, to walk the above labels list.

### inputLengths

*Input.* Pointer to a previously initialized list of the lengths of the timing steps in each batch.

### costs

*Output.* Pointer to the computed costs of CTC.

### gradientsDesc

*Input.* Handle to a previously initialized gradients tensor descriptor.

### gradients

*Output.* Pointer to the computed gradients of CTC. These computed gradient outputs are with respect to the unnormalized activation.

### algo

*Input.* Enumerant that specifies the chosen CTC loss algorithm. See [cudnnCTCLossAlgo\\_t](#).

**ctcLossDesc**

*Input.* Handle to the previously initialized CTC loss descriptor. See [cudnnCTCLossDescriptor\\_t](#).

**workspace**

*Input.* Pointer to GPU memory of a workspace needed to able to execute the specified algorithm.

**sizeInBytes**

*Input.* Amount of GPU memory needed as workspace to be able to execute the CTC loss computation with the specified **algo**.

The possible error values returned by this function and their meanings are listed below.

**Returns****CUDNN\_STATUS\_SUCCESS**

The query was successful.

**CUDNN\_STATUS\_BAD\_PARAM**

At least one of the following conditions are met:

- ▶ The dimensions of probsDesc do not match the dimensions of gradientsDesc.
- ▶ The inputLengths do not agree with the first dimension of probsDesc.
- ▶ The workSpaceSizeInBytes is not sufficient.
- ▶ The labelLengths is greater than 256.

**CUDNN\_STATUS\_NOT\_SUPPORTED**

A compute or data type other than FLOAT was chosen, or an unknown algorithm type was chosen.

**CUDNN\_STATUS\_EXECUTION\_FAILED**

The function failed to launch on the GPU

## 4.38. cudnnDeriveBNTensorDescriptor

```
cudnnStatus_t cudnnDeriveBNTensorDescriptor(
    cudnnTensorDescriptor_t    derivedBnDesc,
    const cudnnTensorDescriptor_t xDesc,
    cudnnBatchNormMode_t      mode)
```

This function derives a secondary tensor descriptor for the batch normalization scale, invVariance, bnBias, bnScale subtensors from the layer's **x** data descriptor.

Use the tensor descriptor produced by this function as the **bnScaleBiasMeanVarDesc** parameter for the [cudnnBatchNormalizationForwardInference](#) and [cudnnBatchNormalizationForwardTraining](#) functions, and as the **bnScaleBiasDiffDesc** parameter in the [cudnnBatchNormalizationBackward](#) function.

The resulting dimensions will be  $1 \times C \times 1 \times 1$  for 4D and  $1 \times C \times 1 \times 1 \times 1$  for 5D for `BATCHNORM_MODE_SPATIAL`, and  $1 \times C \times H \times W$  for 4D and  $1 \times C \times D \times H \times W$  for 5D for `BATCHNORM_MODE_PER_ACTIVATION` mode.

For HALF input data type the resulting tensor descriptor will have a FLOAT type. For other data types it will have the same type as the input data.



Only 4D and 5D tensors are supported.



The `derivedBnDesc` should be first created using `cudaCreateTensorDescriptor`.



`xDesc` is the descriptor for the layer's `x` data and has to be setup with proper dimensions prior to calling this function.

### Parameters

#### `derivedBnDesc`

*Output.* Handle to a previously created tensor descriptor.

#### `xDesc`

*Input.* Handle to a previously created and initialized layer's `x` data descriptor.

#### `mode`

*Input.* Batch normalization layer mode of operation.

### Returns

#### `CUDNN_STATUS_SUCCESS`

The computation was performed successfully.

#### `CUDNN_STATUS_BAD_PARAM`

Invalid Batch Normalization mode.

## 4.39. `cudaDestroy`

```
cudaStatus_t cudaDestroy(cudaHandle_t handle)
```

This function releases resources used by the cuDNN handle. This function is usually the last call with a particular handle to the cuDNN handle. Because `cudaCreate` allocates some internal resources, the release of those resources by calling `cudaDestroy` will implicitly call `cudaDeviceSynchronize`; therefore, the recommended best practice is to call `cudaCreate/cudaDestroy` outside of performance-critical code paths.

### Parameters

#### `handle`

*Input.* Pointer to the cuDNN handle to be destroyed.

### Returns

**CUDNN\_STATUS\_SUCCESS**

The cuDNN context destruction was successful.

**CUDNN\_STATUS\_BAD\_PARAM**

Invalid (NULL) pointer supplied.

## 4.40. cudnnDestroyActivationDescriptor

```

cudnnStatus_t cudnnDestroyActivationDescriptor(
    cudnnActivationDescriptor_t activationDesc)

```

This function destroys a previously created activation descriptor object.

**Returns****CUDNN\_STATUS\_SUCCESS**

The object was destroyed successfully.

## 4.41. cudnnDestroyAlgorithmDescriptor

```

cudnnStatus_t cudnnDestroyAlgorithmDescriptor(
    cudnnActivationDescriptor_t algorithmDesc)

```

**(New for 7.1)**

This function destroys a previously created algorithm descriptor object.

**Returns****CUDNN\_STATUS\_SUCCESS**

The object was destroyed successfully.

## 4.42. cudnnDestroyAlgorithmPerformance

```

cudnnStatus_t cudnnDestroyAlgorithmPerformance(
    cudnnAlgorithmPerformance_t algoPerf)

```

**(New for 7.1)**

This function destroys a previously created algorithm descriptor object.

**Returns****CUDNN\_STATUS\_SUCCESS**

The object was destroyed successfully.

## 4.43. cudnnDestroyAttnDescriptor

```

cudnnStatus_t cudnnDestroyAttnDescriptor(
    cudnnAttnDescriptor_t attnDesc);

```

This function destroys a previously created attention descriptor.

**Parameters:**

Parameter	Input / Output	Description
<code>attnDesc</code>	Input	The attention descriptor to be destroyed.

**Returns:**

Return Value	Description
<code>CUDNN_STATUS_SUCCESS</code>	The descriptor was destroyed successfully.

## 4.44. `cudaDestroyConvolutionDescriptor`

```
cudaStatus_t cudaDestroyConvolutionDescriptor(
    cudaConvolutionDescriptor_t convDesc)
```

This function destroys a previously created convolution descriptor object.

**Returns**

`CUDNN_STATUS_SUCCESS`

The object was destroyed successfully.

## 4.45. `cudaDestroyCTCLossDescriptor`

```
cudaStatus_t cudaDestroyCTCLossDescriptor(
    cudaCTCLossDescriptor_t ctcLossDesc)
```

This function destroys a CTC loss function descriptor object.

**Parameters**

`ctcLossDesc`

*Input.* CTC loss function descriptor to be destroyed.

**Returns**

`CUDNN_STATUS_SUCCESS`

The function returned successfully.

## 4.46. `cudaDestroyDropoutDescriptor`

```
cudaStatus_t cudaDestroyDropoutDescriptor(
    cudaDropoutDescriptor_t dropoutDesc)
```

This function destroys a previously created dropout descriptor object.

**Returns**

`CUDNN_STATUS_SUCCESS`

The object was destroyed successfully.

## 4.47. cudnnDestroyFilterDescriptor

```

cudnnStatus_t cudnnDestroyFilterDescriptor(
    cudnnFilterDescriptor_t filterDesc)

```

This function destroys a previously created Tensor4D descriptor object.

### Returns

**CUDNN\_STATUS\_SUCCESS**

The object was destroyed successfully.

## 4.48. cudnnDestroyFusedOpsConstParamPack

```

cudnnStatus_t cudnnDestroyFusedOpsConstParamPack(
    cudnnFusedOpsConstParamPack_t constPack);

```

This function destroys a previously-created `cudnnFusedOpsConstParamPack_t` structure.

### Parameters:

Parameter	Input / Output	Description
constPack	Input	The <code>cudnnFusedOpsConstParamPack_t</code> structure that should be destroyed.

### Returns:

Return Value	Description
CUDNN_STATUS_SUCCESS	If the descriptor is destroyed successfully.
CUDNN_STATUS_INTERNAL_ERROR	If the <code>ops</code> enum value is not supported or invalid.

## 4.49. cudnnDestroyFusedOpsPlan

```

cudnnStatus_t cudnnDestroyFusedOpsPlan(
    cudnnFusedOpsPlan_t plan);

```

This function destroys the plan descriptor provided.

### Parameters:

Parameter	Input / Output	Description
plan	Input	The descriptor that should be destroyed by this function.

### Returns:

Return Value	Description
--------------	-------------

CUDNN_STATUS_SUCCESS	If either the plan descriptor is NULL or the descriptor is successfully destroyed.
----------------------	--

## 4.50. cudnnDestroyFusedOpsVariantParamPack

```

cudnnStatus_t cudnnDestroyFusedOpsVariantParamPack(
    cudnnFusedOpsVariantParamPack_t varPack);

```

This function destroys a previously-created descriptor for cudnnFusedOps constant parameters.

### Parameters:

Parameter	Input / Output	Description
varPack	Input	The descriptor that should be destroyed.

### Returns:

Return Value	Description
CUDNN_STATUS_SUCCESS	The descriptor is successfully destroyed.

## 4.51. cudnnDestroyLRNDescriptor

```

cudnnStatus_t cudnnDestroyLRNDescriptor(
    cudnnLRNDescriptor_t lrnDesc)

```

This function destroys a previously created LRN descriptor object.

### Returns

**CUDNN\_STATUS\_SUCCESS**

The object was destroyed successfully.

## 4.52. cudnnDestroyOpTensorDescriptor

```

cudnnStatus_t cudnnDestroyOpTensorDescriptor(
    cudnnOpTensorDescriptor_t opTensorDesc)

```

This function deletes a Tensor Pointwise math descriptor object.

### Parameters

#### opTensorDesc

*Input.* Pointer to the structure holding the description of the Tensor Pointwise math to be deleted.

### Returns

**CUDNN\_STATUS\_SUCCESS**

The function returned successfully.

## 4.53. cudnnDestroyPersistentRNNPlan

```

cudnnStatus_t cudnnDestroyPersistentRNNPlan(
    cudnnPersistentRNNPlan_t plan)

```

This function destroys a previously created persistent RNN plan object.

### Returns

**CUDNN\_STATUS\_SUCCESS**

The object was destroyed successfully.

## 4.54. cudnnDestroyPoolingDescriptor

```

cudnnStatus_t cudnnDestroyPoolingDescriptor(
    cudnnPoolingDescriptor_t poolingDesc)

```

This function destroys a previously created pooling descriptor object.

### Returns

**CUDNN\_STATUS\_SUCCESS**

The object was destroyed successfully.

## 4.55. cudnnDestroyReduceTensorDescriptor

```

cudnnStatus_t cudnnDestroyReduceTensorDescriptor(
    cudnnReduceTensorDescriptor_t tensorDesc)

```

This function destroys a previously created reduce tensor descriptor object. When the input pointer is NULL, this function performs no destroy operation.

### Parameters

#### tensorDesc

*Input.* Pointer to the reduce tensor descriptor object to be destroyed.

### Returns

**CUDNN\_STATUS\_SUCCESS**

The object was destroyed successfully.

## 4.56. cudnnDestroyRNNDataDescriptor

```

cudnnStatus_t cudnnDestroyRNNDataDescriptor(
    cudnnRNNDataDescriptor_t RNNDataDesc)

```

This function destroys a previously created RNN data descriptor object.

### Returns



**CUDNN\_STATUS\_SUCCESS**

The RNN data descriptor object was destroyed successfully.

## 4.57. cudnnDestroyRNNDescriptor

```
cudaStatus_t cudnnDestroyRNNDescriptor(
    cudnnRNNDescriptor_t rnnDesc)
```

This function destroys a previously created RNN descriptor object.

**Returns****CUDNN\_STATUS\_SUCCESS**

The object was destroyed successfully.

## 4.58. cudnnDestroySeqDataDescriptor

```
cudaStatus_t cudnnDestroySeqDataDescriptor(cudnnSeqDataDescriptor_t
    seqDataDesc);
```

Destroys a previously created sequence data descriptor.

**Parameters:**

Parameter	Input / Output	Description
seqDataDesc	Input	The sequence data descriptor to be destroyed.

**Returns:**

Return Value	Description
CUDNN_STATUS_SUCCESS	The descriptor was destroyed successfully.

## 4.59. cudnnDestroySpatialTransformerDescriptor

```
cudaStatus_t cudnnDestroySpatialTransformerDescriptor(
    cudnnSpatialTransformerDescriptor_t stDesc)
```

This function destroys a previously created spatial transformer descriptor object.

**Returns****CUDNN\_STATUS\_SUCCESS**

The object was destroyed successfully.

## 4.60. cudnnDestroyTensorDescriptor

```
cudaStatus_t cudnnDestroyTensorDescriptor(cudnnTensorDescriptor_t tensorDesc)
```

This function destroys a previously created tensor descriptor object. When the input pointer is NULL, this function performs no destroy operation.

### Parameters

#### tensorDesc

*Input.* Pointer to the tensor descriptor object to be destroyed.

### Returns

#### CUDNN\_STATUS\_SUCCESS

The object was destroyed successfully.

## 4.61. cudnnDestroyTensorTransformDescriptor

```

cudnnStatus_t cudnnDestroyTensorTransformDescriptor(
    cudnnTensorTransformDescriptor_t transformDesc);

```

Destroys a previously created Tensor transform descriptor.

### Parameters:

Parameter	Input / Output	Description
transformDesc	Input	The Tensor transform descriptor to be destroyed.

### Returns:

Return Value	Description
CUDNN_STATUS_SUCCESS	The descriptor was destroyed successfully.

## 4.62. cudnnDivisiveNormalizationBackward

```

cudnnStatus_t cudnnDivisiveNormalizationBackward(
    cudnnHandle_t          handle,
    cudnnLRNDescriptor_t   normDesc,
    cudnnDivNormMode_t     mode,
    const void             *alpha,
    const cudnnTensorDescriptor_t xDesc,
    const void             *x,
    const void             *means,
    const void             *dy,
    void                  *temp,
    void                  *temp2,
    const void             *beta,
    const cudnnTensorDescriptor_t dxDesc,
    void                  *dx,
    void                  *dMeans)

```

This function performs the backward DivisiveNormalization layer computation.



Supported tensor formats are NCHW for 4D and NCDHW for 5D with any non-overlapping non-negative strides. Only 4D and 5D tensors are supported.

**Parameters****handle**

*Input.* Handle to a previously created cuDNN library descriptor.

**normDesc**

*Input.* Handle to a previously initialized LRN parameter descriptor (this descriptor is used for both LRN and DivisiveNormalization layers).

**mode**

*Input.* DivisiveNormalization layer mode of operation. Currently only CUDNN\_DIVNORM\_PRECOMPUTED\_MEANS is implemented. Normalization is performed using the means input tensor that is expected to be precomputed by the user.

**alpha, beta**

*Input.* Pointers to scaling factors (in host memory) used to blend the layer output value with prior value in the destination tensor as follows:  $\text{dstValue} = \text{alpha}[0] * \text{resultValue} + \text{beta}[0] * \text{priorDstValue}$ . [Please refer to this section for additional details.](#)

**xDesc, x, means**

*Input.* Tensor descriptor and pointers in device memory for the layer's x and means data. Note: the means tensor is expected to be precomputed by the user. It can also contain any valid values (not required to be actual means, and can be for instance a result of a convolution with a Gaussian kernel).

**dy**

*Input.* Tensor pointer in device memory for the layer's dy cumulative loss differential data (error backpropagation).

**temp, temp2**

*Workspace.* Temporary tensors in device memory. These are used for computing intermediate values during the backward pass. These tensors do not have to be preserved from forward to backward pass. Both use xDesc as a descriptor.

**dxDesc**

*Input.* Tensor descriptor for dx and dMeans.

**dx, dMeans**

*Output.* Tensor pointers (in device memory) for the layer's resulting cumulative gradients dx and dMeans (dLoss/dx and dLoss/dMeans). Both share the same descriptor.

Possible error values returned by this function and their meanings are listed below.

**Returns****CUDNN\_STATUS\_SUCCESS**

The computation was performed successfully.

**CUDNN\_STATUS\_BAD\_PARAM**

At least one of the following conditions are met:

- ▶ One of the tensor pointers `x`, `dx`, `temp`, `temp2`, `dy` is NULL.
- ▶ Number of any of the input or output tensor dimensions is not within the [4,5] range.
- ▶ Either alpha or beta pointer is NULL.
- ▶ A mismatch in dimensions between `xDesc` and `dxDesc`.
- ▶ LRN descriptor parameters are outside of their valid ranges.
- ▶ Any of the tensor strides is negative.

#### CUDNN\_STATUS\_UNSUPPORTED

The function does not support the provided configuration. See the following for some examples of non-supported configurations:

- ▶ Any of the input and output tensor strides mismatch (for the same dimension).

## 4.63. cudnnDivisiveNormalizationForward

```

cudnnStatus_t cudnnDivisiveNormalizationForward(
    cudnnHandle_t          handle,
    cudnnLRNDescriptor_t   normDesc,
    cudnnDivNormMode_t     mode,
    const void              *alpha,
    const cudnnTensorDescriptor_t xDesc,
    const void              *x,
    const void              *means,
    void                    *temp,
    void                    *temp2,
    const void              *beta,
    const cudnnTensorDescriptor_t yDesc,
    void                    *y)

```

This function performs the forward spatial DivisiveNormalization layer computation. It divides every value in a layer by the standard deviation of its spatial neighbors as described in *"What is the Best Multi-Stage Architecture for Object Recognition"*, Jarrett 2009, Local Contrast Normalization Layer section. Note that Divisive Normalization only implements the  $x/\max(c, \sigma_x)$  portion of the computation, where  $\sigma_x$  is the variance over the spatial neighborhood of  $x$ . The full LCN (Local Contrastive Normalization) computation can be implemented as a two-step process:

$$x_m = x - \text{mean}(x);$$

$$y = x_m / \max(c, \sigma(x_m));$$

The "x-mean(x)" which is often referred to as "subtractive normalization" portion of the computation can be implemented using cuDNN average pooling layer followed by a call to `addTensor`.



Supported tensor formats are NCHW for 4D and NCDHW for 5D with any non-overlapping non-negative strides. Only 4D and 5D tensors are supported.

#### Parameters

**handle**

*Input.* Handle to a previously created cuDNN library descriptor.

**normDesc**

*Input.* Handle to a previously initialized LRN parameter descriptor. This descriptor is used for both LRN and DivisiveNormalization layers.

**divNormMode**

*Input.* DivisiveNormalization layer mode of operation. Currently only CUDNN\_DIVNORM\_PRECOMPUTED\_MEANS is implemented. Normalization is performed using the means input tensor that is expected to be precomputed by the user.

**alpha, beta**

*Input.* Pointers to scaling factors (in host memory) used to blend the layer output value with prior value in the destination tensor as follows:  $dstValue = alpha[0]*resultValue + beta[0]*priorDstValue$ . [Please refer to this section for additional details.](#)

**xDesc, yDesc**

*Input.* Tensor descriptor objects for the input and output tensors. Note that xDesc is shared between x, means, temp and temp2 tensors.

**x**

*Input.* Input tensor data pointer in device memory.

**means**

*Input.* Input means tensor data pointer in device memory. Note that this tensor can be NULL (in that case its values are assumed to be zero during the computation). This tensor also doesn't have to contain means, these can be any values, a frequently used variation is a result of convolution with a normalized positive kernel (such as Gaussian).

**temp, temp2**

*Workspace.* Temporary tensors in device memory. These are used for computing intermediate values during the forward pass. These tensors do not have to be preserved as inputs from forward to the backward pass. Both use xDesc as their descriptor.

**y**

*Output.* Pointer in device memory to a tensor for the result of the forward DivisiveNormalization computation.

Possible error values returned by this function and their meanings are listed below.

**Returns****CUDNN\_STATUS\_SUCCESS**

The computation was performed successfully.

**CUDNN\_STATUS\_BAD\_PARAM**

At least one of the following conditions are met:

- ▶ One of the tensor pointers **x**, **y**, **temp**, **temp2** is NULL.
- ▶ Number of input tensor or output tensor dimensions is outside of [4,5] range.
- ▶ A mismatch in dimensions between any two of the input or output tensors.
- ▶ For in-place computation when pointers  $x == y$ , a mismatch in strides between the input data and output data tensors.
- ▶ Alpha or beta pointer is NULL.
- ▶ LRN descriptor parameters are outside of their valid ranges.
- ▶ Any of the tensor strides are negative.

#### CUDNN\_STATUS\_UNSUPPORTED

The function does not support the provided configuration. See the following for some examples of non-supported configurations:

- ▶ Any of the input and output tensor strides mismatch (for the same dimension).

## 4.64. cudnnDropoutBackward

```

cudnnStatus_t cudnnDropoutBackward(
    cudnnHandle_t      handle,
    const cudnnDropoutDescriptor_t dropoutDesc,
    const cudnnTensorDescriptor_t dydesc,
    const void         *dy,
    const cudnnTensorDescriptor_t dxdesc,
    void              *dx,
    void              *reserveSpace,
    size_t             reserveSpaceSizeInBytes)

```

This function performs backward dropout operation over **dy** returning results in **dx**. If during forward dropout operation value from **x** was propagated to **y** then during backward operation value from **dy** will be propagated to **dx**, otherwise, **dx** value will be set to 0.



Better performance is obtained for fully packed tensors

### Parameters

#### handle

*Input.* Handle to a previously created cuDNN context.

#### dropoutDesc

*Input.* Previously created dropout descriptor object.

#### dyDesc

*Input.* Handle to a previously initialized tensor descriptor.

#### dy

*Input.* Pointer to data of the tensor described by the **dyDesc** descriptor.

#### dxDesc

*Input.* Handle to a previously initialized tensor descriptor.

**dx**

*Output.* Pointer to data of the tensor described by the **dxDesc** descriptor.

**reserveSpace**

*Input.* Pointer to user-allocated GPU memory used by this function. It is expected that **reserveSpace** was populated during a call to **cudaDnnDropoutForward** and has not been changed.

**reserveSpaceSizeInBytes**

*Input.* Specifies size in bytes of the provided memory for the reserve space

The possible error values returned by this function and their meanings are listed below.

**Returns**

**CUDNN\_STATUS\_SUCCESS**

The call was successful.

**CUDNN\_STATUS\_NOT\_SUPPORTED**

The function does not support the provided configuration.

**CUDNN\_STATUS\_BAD\_PARAM**

At least one of the following conditions are met:

- ▶ The number of elements of input tensor and output tensors differ.
- ▶ The **datatype** of the input tensor and output tensors differs.
- ▶ The strides of the input tensor and output tensors differ and in-place operation is used (i.e., **x** and **y** pointers are equal).
- ▶ The provided **reserveSpaceSizeInBytes** is less than the value returned by **cudaDnnDropoutGetReserveSpaceSize**
- ▶ **cudaDnnSetDropoutDescriptor** has not been called on **dropoutDesc** with the non-NULL **states** argument

**CUDNN\_STATUS\_EXECUTION\_FAILED**

The function failed to launch on the GPU.

## 4.65. cudaDnnDropoutForward

```

cudaDnnStatus_t cudaDnnDropoutForward(
    cudaDnnHandle_t          handle,
    const cudaDnnDropoutDescriptor_t dropoutDesc,
    const cudaDnnTensorDescriptor_t xdesc,
    const void              *x,
    const cudaDnnTensorDescriptor_t ydesc,
    void                    *y,
    void                    *reserveSpace,
    size_t                  reserveSpaceSizeInBytes)

```

This function performs forward dropout operation over **x** returning results in **y**. If **dropout** was used as a parameter to **cudaDnnSetDropoutDescriptor**, the approximately **dropout** fraction of **x** values will be replaced by 0, and the rest will

be scaled by  $1/(1-\text{dropout})$ . This function should not be running concurrently with another `cudaDnnDropoutForward` function using the same `states`.



Better performance is obtained for fully packed tensors



Should not be called during inference

## Parameters

### `handle`

*Input.* Handle to a previously created cuDNN context.

### `dropoutDesc`

*Input.* Previously created dropout descriptor object.

### `xDesc`

*Input.* Handle to a previously initialized tensor descriptor.

### `x`

*Input.* Pointer to data of the tensor described by the `xDesc` descriptor.

### `yDesc`

*Input.* Handle to a previously initialized tensor descriptor.

### `y`

*Output.* Pointer to data of the tensor described by the `yDesc` descriptor.

### `reserveSpace`

*Output.* Pointer to user-allocated GPU memory used by this function. It is expected that contents of `reserveSpace` do not change between `cudaDnnDropoutForward` and `cudaDnnDropoutBackward` calls.

### `reserveSpaceSizeInBytes`

*Input.* Specifies size in bytes of the provided memory for the reserve space.

The possible error values returned by this function and their meanings are listed below.

## Returns

### `CUDNN_STATUS_SUCCESS`

The call was successful.

### `CUDNN_STATUS_NOT_SUPPORTED`

The function does not support the provided configuration.

### `CUDNN_STATUS_BAD_PARAM`

At least one of the following conditions are met:

- ▶ The number of elements of input tensor and output tensors differ.
- ▶ The `datatype` of the input tensor and output tensors differs.



- ▶ The strides of the input tensor and output tensors differ and in-place operation is used (i.e., **x** and **y** pointers are equal).
- ▶ The provided **reserveSpaceSizeInBytes** is less than the value returned by **cudaDnnDropoutGetReserveSpaceSize**.
- ▶ **cudaDnnSetDropoutDescriptor** has not been called on **dropoutDesc** with the non-NULL **states** argument.

#### CUDNN\_STATUS\_EXECUTION\_FAILED

The function failed to launch on the GPU.

## 4.66. cudaDnnDropoutGetReserveSpaceSize

```
cudaDnnStatus_t cudaDnnDropoutGetReserveSpaceSize(
    cudaDnnTensorDescriptor_t xDesc,
    size_t *sizeInBytes)
```

This function is used to query the amount of reserve needed to run dropout with the input dimensions given by **xDesc**. The same reserve space is expected to be passed to **cudaDnnDropoutForward** and **cudaDnnDropoutBackward**, and its contents is expected to remain unchanged between **cudaDnnDropoutForward** and **cudaDnnDropoutBackward** calls.

### Parameters

#### xDesc

*Input.* Handle to a previously initialized tensor descriptor, describing input to a dropout operation.

#### sizeInBytes

*Output.* Amount of GPU memory needed as reserve space to be able to run dropout with an input tensor descriptor specified by **xDesc**.

The possible error values returned by this function and their meanings are listed below.

### Returns

#### CUDNN\_STATUS\_SUCCESS

The query was successful.

## 4.67. cudaDnnDropoutGetStatesSize

```
cudaDnnStatus_t cudaDnnDropoutGetStatesSize(
    cudaDnnHandle_t handle,
    size_t *sizeInBytes)
```

This function is used to query the amount of space required to store the states of the random number generators used by **cudaDnnDropoutForward** function.

### Parameters

#### handle

*Input.* Handle to a previously created cuDNN context.

**sizeInBytes**

*Output.* Amount of GPU memory needed to store random generator states.

The possible error values returned by this function and their meanings are listed below.

**Returns**

**CUDNN\_STATUS\_SUCCESS**

The query was successful.

## 4.68. cudnnFindConvolutionBackwardDataAlgorithm

```

cudnnStatus_t cudnnFindConvolutionBackwardDataAlgorithm(
    cudnnHandle_t          handle,
    const cudnnFilterDescriptor_t  wDesc,
    const cudnnTensorDescriptor_t dyDesc,
    const cudnnConvolutionDescriptor_t convDesc,
    const cudnnTensorDescriptor_t dxDesc,
    const int              requestedAlgoCount,
    int                   *returnedAlgoCount,
    cudnnConvolutionBwdDataAlgoPerf_t *perfResults)

```

This function attempts all algorithms available for `cudnnConvolutionBackwardData()`. It will attempt both the provided `convDesc`'s `mathType` and `CUDNN_DEFAULT_MATH` (assuming the two differ).



Algorithms without the `CUDNN_TENSOR_OP_MATH` availability will only be tried with `CUDNN_DEFAULT_MATH`, and returned as such.

Memory is allocated via `cudaMalloc()`. The performance metrics are returned in the user-allocated array of `cudnnConvolutionBwdDataAlgoPerf_t`. These metrics are written in a sorted fashion where the first element has the lowest compute time. The total number of resulting algorithms can be queried through the API `cudnnGetConvolutionBackwardDataAlgorithmMaxCount()`.



This function is host blocking.



It is recommend to run this function prior to allocating layer data; doing otherwise may needlessly inhibit some algorithm options due to resource usage.

**Parameters****handle**

*Input.* Handle to a previously created cuDNN context.

**wDesc**

*Input.* Handle to a previously initialized filter descriptor.

**dyDesc**

*Input.* Handle to the previously initialized input differential tensor descriptor.

**convDesc**

*Input.* Previously initialized convolution descriptor.

**dxDesc**

*Input.* Handle to the previously initialized output tensor descriptor.

**requestedAlgoCount**

*Input.* The maximum number of elements to be stored in perfResults.

**returnedAlgoCount**

*Output.* The number of output elements stored in perfResults.

**perfResults**

*Output.* A user-allocated array to store performance metrics sorted ascending by compute time.

The possible error values returned by this function and their meanings are listed below.

**Returns****CUDNN\_STATUS\_SUCCESS**

The query was successful.

**CUDNN\_STATUS\_BAD\_PARAM**

At least one of the following conditions are met:

- ▶ **handle** is not allocated properly.
- ▶ **wDesc**, **dyDesc** or **dxDesc** is not allocated properly.
- ▶ **wDesc**, **dyDesc** or **dxDesc** has fewer than 1 dimension.
- ▶ Either **returnedCount** or **perfResults** is nil.
- ▶ **requestedCount** is less than 1.

**CUDNN\_STATUS\_ALLOC\_FAILED**

This function was unable to allocate memory to store sample input, filters and output.

**CUDNN\_STATUS\_INTERNAL\_ERROR**

At least one of the following conditions are met:

- ▶ The function was unable to allocate necessary timing objects.
- ▶ The function was unable to deallocate necessary timing objects.
- ▶ The function was unable to deallocate sample input, filters and output.

## 4.69. cudnnFindConvolutionBackwardDataAlgorithmEx

```

cudnnStatus_t cudnnFindConvolutionBackwardDataAlgorithmEx(
    cudnnHandle_t          handle,
    const cudnnFilterDescriptor_t wDesc,
    const void             *w,
    const cudnnTensorDescriptor_t dyDesc,
    const void             *dy,
    const cudnnConvolutionDescriptor_t convDesc,
    const cudnnTensorDescriptor_t dxDesc,
    void                  *dx,

```

```

const int          requestedAlgoCount,
int               *returnedAlgoCount,
cudnnConvolutionBwdDataAlgoPerf_t *perfResults,
void             *workSpace,
size_t           workspaceSizeInBytes)

```

This function attempts all algorithms available for `cudnnConvolutionBackwardData ()`. It will attempt both the provided `convDesc`'s `mathType` and `CUDNN_DEFAULT_MATH` (assuming the two differ).



Algorithms without the `CUDNN_TENSOR_OP_MATH` availability will only be tried with `CUDNN_DEFAULT_MATH`, and returned as such.

Memory is allocated via `cudaMalloc ()`. The performance metrics are returned in the user-allocated array of `cudnnConvolutionBwdDataAlgoPerf_t`. These metrics are written in a sorted fashion where the first element has the lowest compute time. The total number of resulting algorithms can be queried through the API `cudnnGetConvolutionBackwardDataAlgorithmMaxCount ()`.



This function is host blocking.

## Parameters

### **handle**

*Input.* Handle to a previously created cuDNN context.

### **wDesc**

*Input.* Handle to a previously initialized filter descriptor.

### **w**

*Input.* Data pointer to GPU memory associated with the filter descriptor `wDesc`.

### **dyDesc**

*Input.* Handle to the previously initialized input differential tensor descriptor.

### **dy**

*Input.* Data pointer to GPU memory associated with the filter descriptor `dyDesc`.

### **convDesc**

*Input.* Previously initialized convolution descriptor.

### **dxDesc**

*Input.* Handle to the previously initialized output tensor descriptor.

### **dxDesc**

*Input/Output.* Data pointer to GPU memory associated with the tensor descriptor `dxDesc`. The content of this tensor will be overwritten with arbitrary values.

### **requestedAlgoCount**

*Input.* The maximum number of elements to be stored in `perfResults`.

**returnedAlgoCount**

*Output.* The number of output elements stored in `perfResults`.

**perfResults**

*Output.* A user-allocated array to store performance metrics sorted ascending by compute time.

**workSpace**

*Input.* Data pointer to GPU memory that is a necessary workspace for some algorithms. The size of this workspace will determine the availability of algorithms. A nil pointer is considered a workspace of 0 bytes.

**workSpaceSizeInBytes**

*Input.* Specifies the size in bytes of the provided `workSpace`

The possible error values returned by this function and their meanings are listed below.

**Returns****CUDNN\_STATUS\_SUCCESS**

The query was successful.

**CUDNN\_STATUS\_BAD\_PARAM**

At least one of the following conditions are met:

- ▶ `handle` is not allocated properly.
- ▶ `wDesc`, `dyDesc` or `dxDesc` is not allocated properly.
- ▶ `wDesc`, `dyDesc` or `dxDesc` has fewer than 1 dimension.
- ▶ `w`, `dy` or `dx` is nil.
- ▶ Either `returnedCount` or `perfResults` is nil.
- ▶ `requestedCount` is less than 1.

**CUDNN\_STATUS\_INTERNAL\_ERROR**

At least one of the following conditions are met:

- ▶ The function was unable to allocate necessary timing objects.
- ▶ The function was unable to deallocate necessary timing objects.
- ▶ The function was unable to deallocate sample input, filters and output.

## 4.70. cudnnFindConvolutionBackwardFilterAlgorithm

```

cudnnStatus_t cudnnFindConvolutionBackwardFilterAlgorithm(
cudnnHandle_t          handle,
const cudnnTensorDescriptor_t  xDesc,
const cudnnTensorDescriptor_t  dyDesc,
const cudnnConvolutionDescriptor_t  convDesc,
const cudnnFilterDescriptor_t  dwDesc,
const int              requestedAlgoCount,
int                   *returnedAlgoCount,
cudnnConvolutionBwdFilterAlgoPerf_t  *perfResults)

```

This function attempts all algorithms available for `cudaConvolutionBackwardFilter()`. It will attempt both the provided `convDesc`'s `mathType` and `CUDNN_DEFAULT_MATH` (assuming the two differ).



Algorithms without the `CUDNN_TENSOR_OP_MATH` availability will only be tried with `CUDNN_DEFAULT_MATH`, and returned as such.

Memory is allocated via `cudaMalloc()`. The performance metrics are returned in the user-allocated array of `cudaConvolutionBwdFilterAlgoPerf_t`. These metrics are written in a sorted fashion where the first element has the lowest compute time. The total number of resulting algorithms can be queried through the API `cudaGetConvolutionBackwardFilterAlgorithmMaxCount()`.



This function is host blocking.



It is recommend to run this function prior to allocating layer data; doing otherwise may needlessly inhibit some algorithm options due to resource usage.

## Parameters

### **handle**

*Input.* Handle to a previously created cuDNN context.

### **xDesc**

*Input.* Handle to the previously initialized input tensor descriptor.

### **dyDesc**

*Input.* Handle to the previously initialized input differential tensor descriptor.

### **convDesc**

*Input.* Previously initialized convolution descriptor.

### **dwDesc**

*Input.* Handle to a previously initialized filter descriptor.

### **requestedAlgoCount**

*Input.* The maximum number of elements to be stored in `perfResults`.

### **returnedAlgoCount**

*Output.* The number of output elements stored in `perfResults`.

### **perfResults**

*Output.* A user-allocated array to store performance metrics sorted ascending by compute time.

The possible error values returned by this function and their meanings are listed below.

## Returns

**CUDNN\_STATUS\_SUCCESS**

The query was successful.

**CUDNN\_STATUS\_BAD\_PARAM**

At least one of the following conditions are met:

- ▶ **handle** is not allocated properly.
- ▶ **xDesc**, **dyDesc** or **dwDesc** is not allocated properly.
- ▶ **xDesc**, **dyDesc** or **dwDesc** has fewer than 1 dimension.
- ▶ Either **returnedCount** or **perfResults** is nil.
- ▶ **requestedCount** is less than 1.

**CUDNN\_STATUS\_ALLOC\_FAILED**

This function was unable to allocate memory to store sample input, filters and output.

**CUDNN\_STATUS\_INTERNAL\_ERROR**

At least one of the following conditions are met:

- ▶ The function was unable to allocate necessary timing objects.
- ▶ The function was unable to deallocate necessary timing objects.
- ▶ The function was unable to deallocate sample input, filters and output.

## 4.71. cudnnFindConvolutionBackwardFilterAlgorithmEx

```

cudnnStatus_t cudnnFindConvolutionBackwardFilterAlgorithmEx(
    cudnnHandle_t          handle,
    const cudnnTensorDescriptor_t xDesc,
    const void             *x,
    const cudnnTensorDescriptor_t dyDesc,
    const void             *dy,
    const cudnnConvolutionDescriptor_t convDesc,
    const cudnnFilterDescriptor_t dwDesc,
    void                  *dw,
    const int              requestedAlgoCount,
    int                    *returnedAlgoCount,
    cudnnConvolutionBwdFilterAlgoPerf_t *perfResults,
    void                  *workSpace,
    size_t                 workSpaceSizeInBytes)

```

This function attempts all algorithms available for `cudnnConvolutionBackwardFilter()`. It will attempt both the provided `convDesc`'s `mathType` and `CUDNN_DEFAULT_MATH` (assuming the two differ).



Algorithms without the `CUDNN_TENSOR_OP_MATH` availability will only be tried with `CUDNN_DEFAULT_MATH`, and returned as such.

Memory is allocated via `cudaMalloc()`. The performance metrics are returned in the user-allocated array of `cudnnConvolutionBwdFilterAlgoPerf_t`. These metrics are written in a sorted fashion where the first element has the lowest compute

time. The total number of resulting algorithms can be queried through the API `cudaGetConvolutionBackwardFilterAlgorithmMaxCount()`.



This function is host blocking.

### Parameters

#### **handle**

*Input.* Handle to a previously created cuDNN context.

#### **xDesc**

*Input.* Handle to the previously initialized input tensor descriptor.

#### **x**

*Input.* Data pointer to GPU memory associated with the filter descriptor **xDesc**.

#### **dyDesc**

*Input.* Handle to the previously initialized input differential tensor descriptor.

#### **dy**

*Input.* Data pointer to GPU memory associated with the tensor descriptor **dyDesc**.

#### **convDesc**

*Input.* Previously initialized convolution descriptor.

#### **dwDesc**

*Input.* Handle to a previously initialized filter descriptor.

#### **dw**

*Input/Output.* Data pointer to GPU memory associated with the filter descriptor **dwDesc**. The content of this tensor will be overwritten with arbitrary values.

#### **requestedAlgoCount**

*Input.* The maximum number of elements to be stored in perfResults.

#### **returnedAlgoCount**

*Output.* The number of output elements stored in perfResults.

#### **perfResults**

*Output.* A user-allocated array to store performance metrics sorted ascending by compute time.

#### **workSpace**

*Input.* Data pointer to GPU memory that is a necessary workspace for some algorithms. The size of this workspace will determine the availability of algorithms. A nil pointer is considered a workspace of 0 bytes.

#### **workSpaceSizeInBytes**

*Input.* Specifies the size in bytes of the provided **workSpace**

The possible error values returned by this function and their meanings are listed below.



## Returns

### CUDNN\_STATUS\_SUCCESS

The query was successful.

### CUDNN\_STATUS\_BAD\_PARAM

At least one of the following conditions are met:

- ▶ **handle** is not allocated properly.
- ▶ **xDesc**, **dyDesc** or **dwDesc** is not allocated properly.
- ▶ **xDesc**, **dyDesc** or **dwDesc** has fewer than 1 dimension.
- ▶ **x**, **dy** or **dw** is nil.
- ▶ Either **returnedCount** or **perfResults** is nil.
- ▶ **requestedCount** is less than 1.

### CUDNN\_STATUS\_INTERNAL\_ERROR

At least one of the following conditions are met:

- ▶ The function was unable to allocate necessary timing objects.
- ▶ The function was unable to deallocate necessary timing objects.
- ▶ The function was unable to deallocate sample input, filters and output.

## 4.72. cudnnFindConvolutionForwardAlgorithm

```

cudnnStatus_t cudnnFindConvolutionForwardAlgorithm(
    cudnnHandle_t          handle,
    const cudnnTensorDescriptor_t  xDesc,
    const cudnnFilterDescriptor_t   wDesc,
    const cudnnConvolutionDescriptor_t convDesc,
    const cudnnTensorDescriptor_t  yDesc,
    const int              requestedAlgoCount,
    int                    *returnedAlgoCount,
    cudnnConvolutionFwdAlgoPerf_t  *perfResults)

```

This function attempts all algorithms available for `cudnnConvolutionForward()`. It will attempt both the provided `convDesc`'s `mathType` and `CUDNN_DEFAULT_MATH` (assuming the two differ).



Algorithms without the `CUDNN_TENSOR_OP_MATH` availability will only be tried with `CUDNN_DEFAULT_MATH`, and returned as such.

Memory is allocated via `cudaMalloc()`. The performance metrics are returned in the user-allocated array of `cudnnConvolutionFwdAlgoPerf_t`. These metrics are written in a sorted fashion where the first element has the lowest compute

time. The total number of resulting algorithms can be queried through the API `cudaGetConvolutionForwardAlgorithmMaxCount()`.



This function is host blocking.



It is recommended to run this function prior to allocating layer data; doing otherwise may needlessly inhibit some algorithm options due to resource usage.

## Parameters

### **handle**

*Input.* Handle to a previously created cuDNN context.

### **xDesc**

*Input.* Handle to the previously initialized input tensor descriptor.

### **wDesc**

*Input.* Handle to a previously initialized filter descriptor.

### **convDesc**

*Input.* Previously initialized convolution descriptor.

### **yDesc**

*Input.* Handle to the previously initialized output tensor descriptor.

### **requestedAlgoCount**

*Input.* The maximum number of elements to be stored in `perfResults`.

### **returnedAlgoCount**

*Output.* The number of output elements stored in `perfResults`.

### **perfResults**

*Output.* A user-allocated array to store performance metrics sorted ascending by compute time.

The possible error values returned by this function and their meanings are listed below.

## Returns

### **CUDNN\_STATUS\_SUCCESS**

The query was successful.

### **CUDNN\_STATUS\_BAD\_PARAM**

At least one of the following conditions are met:

- ▶ **handle** is not allocated properly.
- ▶ **xDesc**, **wDesc** or **yDesc** is not allocated properly.
- ▶ **xDesc**, **wDesc** or **yDesc** has fewer than 1 dimension.
- ▶ Either **returnedCount** or **perfResults** is nil.
- ▶ **requestedCount** is less than 1.

**CUDNN\_STATUS\_ALLOC\_FAILED**

This function was unable to allocate memory to store sample input, filters and output.

**CUDNN\_STATUS\_INTERNAL\_ERROR**

At least one of the following conditions are met:

- ▶ The function was unable to allocate necessary timing objects.
- ▶ The function was unable to deallocate necessary timing objects.
- ▶ The function was unable to deallocate sample input, filters and output.

## 4.73. cudnnFindConvolutionForwardAlgorithmEx

```

cudnnStatus_t cudnnFindConvolutionForwardAlgorithmEx(
    cudnnHandle_t          handle,
    const cudnnTensorDescriptor_t  xDesc,
    const void             *x,
    const cudnnFilterDescriptor_t  wDesc,
    const void             *w,
    const cudnnConvolutionDescriptor_t  convDesc,
    const cudnnTensorDescriptor_t  yDesc,
    void                   *y,
    const int              requestedAlgoCount,
    int                    *returnedAlgoCount,
    cudnnConvolutionFwdAlgoPerf_t  *perfResults,
    void                   *workSpace,
    size_t                 workSpaceSizeInBytes)

```

This function attempts all algorithms available for `cudnnConvolutionForward()`. It will attempt both the provided `convDesc`'s `mathType` and `CUDNN_DEFAULT_MATH` (assuming the two differ).



Algorithms without the `CUDNN_TENSOR_OP_MATH` availability will only be tried with `CUDNN_DEFAULT_MATH`, and returned as such.

Memory is allocated via `cudaMalloc()`. The performance metrics are returned in the user-allocated array of `cudnnConvolutionFwdAlgoPerf_t`. These metrics are written in a sorted fashion where the first element has the lowest compute time. The total number of resulting algorithms can be queried through the API `cudnnGetConvolutionForwardAlgorithmMaxCount()`.



This function is host blocking.

### Parameters

#### handle

*Input.* Handle to a previously created cuDNN context.

#### xDesc

*Input.* Handle to the previously initialized input tensor descriptor.

#### x

*Input.* Data pointer to GPU memory associated with the tensor descriptor `xDesc`.

**wDesc**

*Input.* Handle to a previously initialized filter descriptor.

**w**

*Input.* Data pointer to GPU memory associated with the filter descriptor **wDesc**.

**convDesc**

*Input.* Previously initialized convolution descriptor.

**yDesc**

*Input.* Handle to the previously initialized output tensor descriptor.

**y**

*Input/Output.* Data pointer to GPU memory associated with the tensor descriptor **yDesc**. The content of this tensor will be overwritten with arbitrary values.

**requestedAlgoCount**

*Input.* The maximum number of elements to be stored in perfResults.

**returnedAlgoCount**

*Output.* The number of output elements stored in perfResults.

**perfResults**

*Output.* A user-allocated array to store performance metrics sorted ascending by compute time.

**workSpace**

*Input.* Data pointer to GPU memory that is a necessary workspace for some algorithms. The size of this workspace will determine the availability of algorithms. A nil pointer is considered a workSpace of 0 bytes.

**workSpaceSizeInBytes**

*Input.* Specifies the size in bytes of the provided **workSpace**.

The possible error values returned by this function and their meanings are listed below.

**Returns****CUDNN\_STATUS\_SUCCESS**

The query was successful.

**CUDNN\_STATUS\_BAD\_PARAM**

At least one of the following conditions are met:

- ▶ **handle** is not allocated properly.
- ▶ **xDesc**, **wDesc** or **yDesc** is not allocated properly.
- ▶ **xDesc**, **wDesc** or **yDesc** has fewer than 1 dimension.
- ▶ **x**, **w** or **y** is nil.
- ▶ Either **returnedCount** or **perfResults** is nil.
- ▶ **requestedCount** is less than 1.

**CUDNN\_STATUS\_INTERNAL\_ERROR**

At least one of the following conditions are met:

- ▶ The function was unable to allocate necessary timing objects.
- ▶ The function was unable to deallocate necessary timing objects.
- ▶ The function was unable to deallocate sample input, filters and output.

## 4.74. cudnnFindRNNBackwardDataAlgorithmEx

```

cudnnStatus_t cudnnFindRNNBackwardDataAlgorithmEx(
    cudnnHandle_t          handle,
    const cudnnRNNDescriptor_t  rnnDesc,
    const int              seqLength,
    const cudnnTensorDescriptor_t *yDesc,
    const void             *y,
    const cudnnTensorDescriptor_t *dyDesc,
    const void             *dy,
    const cudnnTensorDescriptor_t dhDesc,
    const void             *dh,
    const cudnnTensorDescriptor_t dcDesc,
    const void             *dc,
    const cudnnFilterDescriptor_t wDesc,
    const void             *w,
    const cudnnTensorDescriptor_t hxDesc,
    const void             *hx,
    const cudnnTensorDescriptor_t cxDesc,
    const void             *cx,
    const cudnnTensorDescriptor_t dxDesc,
    void                  *dx,
    const cudnnTensorDescriptor_t dhxDesc,
    void                  *dhx,
    const cudnnTensorDescriptor_t dcxDesc,
    void                  *dcx,
    const float            findIntensity,
    const int              requestedAlgoCount,
    int                   *returnedAlgoCount,
    cudnnAlgorithmPerformance_t *perfResults,
    void                  *workspace,
    size_t                 workSpaceSizeInBytes,
    const void             *reserveSpace,
    size_t                 reserveSpaceSizeInBytes)

```

### (New for 7.1)

This function attempts all available cuDNN algorithms for **cudnnRNNBackwardData**, using user-allocated GPU memory. It outputs the parameters that influence the performance of the algorithm to a user-allocated array of **cudnnAlgorithmPerformance\_t**. These parameter metrics are written in sorted fashion where the first element has the lowest compute time.

#### Parameters

##### handle

*Input.* Handle to a previously created cuDNN context.

##### rnnDesc

*Input.* A previously initialized RNN descriptor.

**seqLength**

*Input.* Number of iterations to unroll over. The value of this **seqLength** must not exceed the value that was used in **cudaGetRNNWorkspaceSize()** function for querying the workspace size required to execute the RNN.

**yDesc**

*Input.* An array of fully packed tensor descriptors describing the output from each recurrent iteration (one descriptor per iteration). The second dimension of the tensor depends on the **direction** argument passed to the **cudaSetRNNDescriptor** call used to initialize **rnnDesc**:

- ▶ If **direction** is **CUDNN\_UNIDIRECTIONAL** the second dimension should match the **hiddenSize** argument passed to **cudaSetRNNDescriptor**.
- ▶ If **direction** is **CUDNN\_BIDIRECTIONAL** the second dimension should match double the **hiddenSize** argument passed to **cudaSetRNNDescriptor**.

The first dimension of the tensor **n** must match the first dimension of the tensor **n** in **dyDesc**.

**y**

*Input.* Data pointer to GPU memory associated with the output tensor descriptor **yDesc**.

**dyDesc**

*Input.* An array of fully packed tensor descriptors describing the gradient at the output from each recurrent iteration (one descriptor per iteration). The second dimension of the tensor depends on the **direction** argument passed to the **cudaSetRNNDescriptor** call used to initialize **rnnDesc**:

- ▶ If **direction** is **CUDNN\_UNIDIRECTIONAL** the second dimension should match the **hiddenSize** argument passed to **cudaSetRNNDescriptor**.
- ▶ If **direction** is **CUDNN\_BIDIRECTIONAL** the second dimension should match double the **hiddenSize** argument passed to **cudaSetRNNDescriptor**.

The first dimension of the tensor **n** must match the second dimension of the tensor **n** in **dxDesc**.

**dy**

*Input.* Data pointer to GPU memory associated with the tensor descriptors in the array **dyDesc**.

**dhyDesc**

*Input.* A fully packed tensor descriptor describing the gradients at the final hidden state of the RNN. The first dimension of the tensor depends on the **direction** argument passed to the **cudaSetRNNDescriptor** call used to initialize **rnnDesc**:

- ▶ If **direction** is **CUDNN\_UNIDIRECTIONAL** the first dimension should match the **numLayers** argument passed to **cudaSetRNNDescriptor**.
- ▶ If **direction** is **CUDNN\_BIDIRECTIONAL** the first dimension should match double the **numLayers** argument passed to **cudaSetRNNDescriptor**.

The second dimension must match the first dimension of the tensors described in **dxDesc**. The third dimension must match the **hiddenSize** argument passed to the **cudaSetRNNDescriptor** call used to initialize **rnnDesc**. The tensor must be fully packed.

### **dhy**

*Input.* Data pointer to GPU memory associated with the tensor descriptor **dhyDesc**. If a NULL pointer is passed, the gradients at the final hidden state of the network will be initialized to zero.

### **dcyDesc**

*Input.* A fully packed tensor descriptor describing the gradients at the final cell state of the RNN. The first dimension of the tensor depends on the **direction** argument passed to the **cudaSetRNNDescriptor** call used to initialize **rnnDesc**:

- ▶ If **direction** is **CUDNN\_UNIDIRECTIONAL** the first dimension should match the **numLayers** argument passed to **cudaSetRNNDescriptor**.
- ▶ If **direction** is **CUDNN\_BIDIRECTIONAL** the first dimension should match double the **numLayers** argument passed to **cudaSetRNNDescriptor**.

The second dimension must match the first dimension of the tensors described in **dxDesc**. The third dimension must match the **hiddenSize** argument passed to the **cudaSetRNNDescriptor** call used to initialize **rnnDesc**. The tensor must be fully packed.

### **dcy**

*Input.* Data pointer to GPU memory associated with the tensor descriptor **dcyDesc**. If a NULL pointer is passed, the gradients at the final cell state of the network will be initialized to zero.

### **wDesc**

*Input.* Handle to a previously initialized filter descriptor describing the weights for the RNN.

### **w**

*Input.* Data pointer to GPU memory associated with the filter descriptor **wDesc**.

### **hxDesc**

*Input.* A fully packed tensor descriptor describing the initial hidden state of the RNN. The first dimension of the tensor depends on the **direction** argument passed to the **cudaSetRNNDescriptor** call used to initialize **rnnDesc**:

- ▶ If **direction** is **CUDNN\_UNIDIRECTIONAL** the first dimension should match the **numLayers** argument passed to **cudaSetRNNDescriptor**.
- ▶ If **direction** is **CUDNN\_BIDIRECTIONAL** the first dimension should match double the **numLayers** argument passed to **cudaSetRNNDescriptor**.

The second dimension must match the first dimension of the tensors described in **dxDesc**. The third dimension must match the **hiddenSize** argument passed to the **cudaSetRNNDescriptor** call used to initialize **rnnDesc**. The tensor must be fully packed.

**hx**

*Input.* Data pointer to GPU memory associated with the tensor descriptor **hxDesc**. If a NULL pointer is passed, the initial hidden state of the network will be initialized to zero.

**cxDesc**

*Input.* A fully packed tensor descriptor describing the initial cell state for LSTM networks. The first dimension of the tensor depends on the **direction** argument passed to the **cudaSetRNNDescriptor** call used to initialize **rnnDesc**:

- ▶ If **direction** is **CUDNN\_UNIDIRECTIONAL** the first dimension should match the **numLayers** argument passed to **cudaSetRNNDescriptor**.
- ▶ If **direction** is **CUDNN\_BIDIRECTIONAL** the first dimension should match double the **numLayers** argument passed to **cudaSetRNNDescriptor**.

The second dimension must match the first dimension of the tensors described in **dxDesc**. The third dimension must match the **hiddenSize** argument passed to the **cudaSetRNNDescriptor** call used to initialize **rnnDesc**. The tensor must be fully packed.

**cx**

*Input.* Data pointer to GPU memory associated with the tensor descriptor **cxDesc**. If a NULL pointer is passed, the initial cell state of the network will be initialized to zero.

**dxDesc**

*Input.* An array of fully packed tensor descriptors describing the gradient at the input of each recurrent iteration (one descriptor per iteration). The first dimension (batch size) of the tensors may decrease from element **n** to element **n+1** but may not increase. Each tensor descriptor must have the same second dimension (vector length).

**dx**

*Output.* Data pointer to GPU memory associated with the tensor descriptors in the array **dxDesc**.

**dhxDesc**

*Input.* A fully packed tensor descriptor describing the gradient at the initial hidden state of the RNN. The first dimension of the tensor depends on the **direction** argument passed to the **cudaSetRNNDescriptor** call used to initialize **rnnDesc**:

- ▶ If **direction** is **CUDNN\_UNIDIRECTIONAL** the first dimension should match the **numLayers** argument passed to **cudaSetRNNDescriptor**.
- ▶ If **direction** is **CUDNN\_BIDIRECTIONAL** the first dimension should match double the **numLayers** argument passed to **cudaSetRNNDescriptor**.

The second dimension must match the first dimension of the tensors described in **dxDesc**. The third dimension must match the **hiddenSize** argument passed to the **cudaSetRNNDescriptor** call used to initialize **rnnDesc**. The tensor must be fully packed.



**dhx**

*Output.* Data pointer to GPU memory associated with the tensor descriptor **dhxDesc**. If a NULL pointer is passed, the gradient at the hidden input of the network will not be set.

**dcxDesc**

*Input.* A fully packed tensor descriptor describing the gradient at the initial cell state of the RNN. The first dimension of the tensor depends on the **direction** argument passed to the **cudaSetRNNDesc** call used to initialize **rnnDesc**:

- ▶ If **direction** is **CUDNN\_UNIDIRECTIONAL** the first dimension should match the **numLayers** argument passed to **cudaSetRNNDesc**.
- ▶ If **direction** is **CUDNN\_BIDIRECTIONAL** the first dimension should match double the **numLayers** argument passed to **cudaSetRNNDesc**.

The second dimension must match the first dimension of the tensors described in **dxDesc**. The third dimension must match the **hiddenSize** argument passed to the **cudaSetRNNDesc** call used to initialize **rnnDesc**. The tensor must be fully packed.

**dcx**

*Output.* Data pointer to GPU memory associated with the tensor descriptor **dcxDesc**. If a NULL pointer is passed, the gradient at the cell input of the network will not be set.

**findIntensity**

*Input.* This input was previously unused in versions prior to 7.2.0. It is used in cuDNN 7.2.0 and later versions to control the overall runtime of the RNN find algorithms, by selecting the percentage of a large Cartesian product space to be searched.

- ▶ Setting **findIntensity** within the range (0,1.] will set a percentage of the entire RNN search space to search. When **findIntensity** is set to 1.0, a full search is performed over all RNN parameters.
- ▶ When **findIntensity** is set to 0.0f, a quick, minimal search is performed. This setting has the best runtime. However, in this case the parameters returned by this function will not correspond to the best performance of the algorithm; a longer search might discover better parameters. This option will execute up to three instances of the configured RNN problem. Runtime will vary proportionally to RNN problem size, as it will in the other cases, hence no guarantee of an explicit time bound can be given.
- ▶ Setting **findIntensity** within the range [-1.,0) sets a percentage of a reduced Cartesian product space to be searched. This reduced searched space has been heuristically selected to have good performance. The setting of -1.0 represents a full search over this reduced search space.
- ▶ Values outside the range [-1,1] are truncated to the range [-1,1], and then interpreted as per the above.
- ▶ Setting **findIntensity** to 1.0 in cuDNN 7.2 and later versions is equivalent to the behavior of this function in versions prior to cuDNN 7.2.0.

- ▶ This function times the single RNN executions over large parameter spaces--one execution per parameter combination. The times returned by this function are latencies.

**requestedAlgoCount**

*Input.* The maximum number of elements to be stored in perfResults.

**returnedAlgoCount**

*Output.* The number of output elements stored in perfResults.

**perfResults**

*Output.* A user-allocated array to store performance metrics sorted ascending by compute time.

**workspace**

*Input.* Data pointer to GPU memory to be used as a workspace for this call.

**workspaceSizeInBytes**

*Input.* Specifies the size in bytes of the provided **workspace**.

**reserveSpace**

*Input/Output.* Data pointer to GPU memory to be used as a reserve space for this call.

**reserveSpaceSizeInBytes**

*Input.* Specifies the size in bytes of the provided **reserveSpace**.

The possible error values returned by this function and their meanings are listed below.

**Returns****CUDNN\_STATUS\_SUCCESS**

The function launched successfully.

**CUDNN\_STATUS\_NOT\_SUPPORTED**

The function does not support the provided configuration.

**CUDNN\_STATUS\_BAD\_PARAM**

At least one of the following conditions are met:

- ▶ The descriptor **rnnDesc** is invalid.
- ▶ At least one of the descriptors **dhxDesc**, **wDesc**, **hxDesc**, **cxDesc**, **dcxDesc**, **dhyDesc**, **dcyDesc** or one of the descriptors in **yDesc**, **dxdesc**, **dydesc** is invalid.
- ▶ The descriptors in one of **yDesc**, **dxDesc**, **dyDesc**, **dhxDesc**, **wDesc**, **hxDesc**, **cxDesc**, **dcxDesc**, **dhyDesc**, **dcyDesc** has incorrect strides or dimensions.
- ▶ **workspaceSizeInBytes** is too small.
- ▶ **reserveSpaceSizeInBytes** is too small.

**CUDNN\_STATUS\_EXECUTION\_FAILED**

The function failed to launch on the GPU.

**CUDNN\_STATUS\_ALLOC\_FAILED**

The function was unable to allocate memory.

## 4.75. cudnnFindRNNBackwardWeightsAlgorithmEx

```

cudnnStatus_t cudnnFindRNNBackwardWeightsAlgorithmEx(
    cudnnHandle_t          handle,
    const cudnnRNNDescriptor_t  rnnDesc,
    const int              seqLength,
    const cudnnTensorDescriptor_t *xDesc,
    const void             *x,
    const cudnnTensorDescriptor_t hxDesc,
    const void             *hx,
    const cudnnTensorDescriptor_t yDesc,
    const void             *y,
    const float            findIntensity,
    const int              requestedAlgoCount,
    int                    *returnedAlgoCount,
    cudnnAlgorithmPerformance_t *perfResults,
    const void             *workspace,
    size_t                 workSpaceSizeInBytes,
    const cudnnFilterDescriptor_t dwDesc,
    void                   *dw,
    const void             *reserveSpace,
    size_t                 reserveSpaceSizeInBytes)

```

### (New for 7.1)

This function attempts all available cuDNN algorithms for **cudnnRNNBackwardWeights**, using user-allocated GPU memory. It outputs the parameters that influence the performance of the algorithm to a user-allocated array of **cudnnAlgorithmPerformance\_t**. These parameter metrics are written in sorted fashion where the first element has the lowest compute time.

### Parameters

#### handle

*Input.* Handle to a previously created cuDNN context.

#### rnnDesc

*Input.* A previously initialized RNN descriptor.

#### seqLength

*Input.* Number of iterations to unroll over. The value of this **seqLength** must not exceed the value that was used in **cudnnGetRNNWorkspaceSize()** function for querying the workspace size required to execute the RNN.

#### xDesc

*Input.* An array of fully packed tensor descriptors describing the input to each recurrent iteration (one descriptor per iteration). The first dimension (batch size) of the tensors may decrease from element **n** to element **n+1** but may not increase. Each tensor descriptor must have the same second dimension (vector length).

**x**

*Input.* Data pointer to GPU memory associated with the tensor descriptors in the array **xDesc**.

**hxDesc**

*Input.* A fully packed tensor descriptor describing the initial hidden state of the RNN. The first dimension of the tensor depends on the **direction** argument passed to the **cudaSetRNNDescriptor** call used to initialize **rnnDesc**:

- ▶ If **direction** is **CUDNN\_UNIDIRECTIONAL** the first dimension should match the **numLayers** argument passed to **cudaSetRNNDescriptor**.
- ▶ If **direction** is **CUDNN\_BIDIRECTIONAL** the first dimension should match double the **numLayers** argument passed to **cudaSetRNNDescriptor**.

The second dimension must match the first dimension of the tensors described in **xDesc**. The third dimension must match the **hiddenSize** argument passed to the **cudaSetRNNDescriptor** call used to initialize **rnnDesc**. The tensor must be fully packed.

**hx**

*Input.* Data pointer to GPU memory associated with the tensor descriptor **hxDesc**. If a NULL pointer is passed, the initial hidden state of the network will be initialized to zero.

**yDesc**

*Input.* An array of fully packed tensor descriptors describing the output from each recurrent iteration (one descriptor per iteration). The second dimension of the tensor depends on the **direction** argument passed to the **cudaSetRNNDescriptor** call used to initialize **rnnDesc**:

- ▶ If **direction** is **CUDNN\_UNIDIRECTIONAL** the second dimension should match the **hiddenSize** argument passed to **cudaSetRNNDescriptor**.
- ▶ If **direction** is **CUDNN\_BIDIRECTIONAL** the second dimension should match double the **hiddenSize** argument passed to **cudaSetRNNDescriptor**.

The first dimension of the tensor **n** must match the first dimension of the tensor **n** in **dyDesc**.

**y**

*Input.* Data pointer to GPU memory associated with the output tensor descriptor **yDesc**.

**findIntensity**

*Input.* This input was previously unused in versions prior to 7.2.0. It is used in cuDNN 7.2.0 and later versions to control the overall runtime of the RNN find algorithms, by selecting the percentage of a large Cartesian product space to be searched.

- ▶ Setting **findIntensity** within the range (0,1.] will set a percentage of the entire RNN search space to search. When **findIntensity** is set to 1.0, a full search is performed over all RNN parameters.

- ▶ When **findIntensity** is set to 0.0f, a quick, minimal search is performed. This setting has the best runtime. However, in this case the parameters returned by this function will not correspond to the best performance of the algorithm; a longer search might discover better parameters. This option will execute up to three instances of the configured RNN problem. Runtime will vary proportionally to RNN problem size, as it will in the other cases, hence no guarantee of an explicit time bound can be given.
- ▶ Setting **findIntensity** within the range [-1.,0) sets a percentage of a reduced Cartesian product space to be searched. This reduced searched space has been heuristically selected to have good performance. The setting of -1.0 represents a full search over this reduced search space.
- ▶ Values outside the range [-1,1] are truncated to the range [-1,1], and then interpreted as per the above.
- ▶ Setting **findIntensity** to 1.0 in cuDNN 7.2 and later versions is equivalent to the behavior of this function in versions prior to cuDNN 7.2.0.
- ▶ This function times the single RNN executions over large parameter spaces--one execution per parameter combination. The times returned by this function are latencies.

#### **requestedAlgoCount**

*Input.* The maximum number of elements to be stored in perfResults.

#### **returnedAlgoCount**

*Output.* The number of output elements stored in perfResults.

#### **perfResults**

*Output.* A user-allocated array to store performance metrics sorted ascending by compute time.

#### **workspace**

*Input.* Data pointer to GPU memory to be used as a workspace for this call.

#### **workspaceSizeInBytes**

*Input.* Specifies the size in bytes of the provided **workspace**.

#### **dwDesc**

*Input.* Handle to a previously initialized filter descriptor describing the gradients of the weights for the RNN.

#### **dw**

*Input/Output.* Data pointer to GPU memory associated with the filter descriptor **dwDesc**.

#### **reserveSpace**

*Input.* Data pointer to GPU memory to be used as a reserve space for this call.

#### **reserveSpaceSizeInBytes**

*Input.* Specifies the size in bytes of the provided **reserveSpace**

The possible error values returned by this function and their meanings are listed below.

**Returns****CUDNN\_STATUS\_SUCCESS**

The function launched successfully.

**CUDNN\_STATUS\_NOT\_SUPPORTED**

The function does not support the provided configuration.

**CUDNN\_STATUS\_BAD\_PARAM**

At least one of the following conditions are met:

- ▶ The descriptor **rnnDesc** is invalid.
- ▶ At least one of the descriptors **hxDesc**, **dwDesc** or one of the descriptors in **xDesc**, **yDesc** is invalid.
- ▶ The descriptors in one of **xDesc**, **hxDesc**, **yDesc**, **dwDesc** has incorrect strides or dimensions.
- ▶ **workspaceSizeInBytes** is too small.
- ▶ **reserveSpaceSizeInBytes** is too small.

**CUDNN\_STATUS\_EXECUTION\_FAILED**

The function failed to launch on the GPU.

**CUDNN\_STATUS\_ALLOC\_FAILED**

The function was unable to allocate memory.

## 4.76. cudnnFindRNNForwardInferenceAlgorithmEx

```

cudnnStatus_t cudnnFindRNNForwardInferenceAlgorithmEx(
    cudnnHandle_t          handle,
    const cudnnRNNDescriptor_t  rnnDesc,
    const int              seqLength,
    const cudnnTensorDescriptor_t *xDesc,
    const void             *x,
    const cudnnTensorDescriptor_t hxDesc,
    const void             *hx,
    const cudnnTensorDescriptor_t cxDesc,
    const void             *cx,
    const cudnnFilterDescriptor_t wDesc,
    const void             *w,
    const cudnnTensorDescriptor_t *yDesc,
    void                  *y,
    const cudnnTensorDescriptor_t hyDesc,
    void                  *hy,
    const cudnnTensorDescriptor_t cyDesc,
    void                  *cy,
    const float            findIntensity,
    const int              requestedAlgoCount,
    int                    *returnedAlgoCount,
    cudnnAlgorithmPerformance_t *perfResults,
    void                  *workspace,
    size_t                 workspaceSizeInBytes)

```

(New for 7.1)

This function attempts all available cuDNN algorithms for **cudaNNForwardInference**, using user-allocated GPU memory. It outputs the parameters that influence the performance of the algorithm to a user-allocated array of **cudaAlgorithmPerformance\_t**. These parameter metrics are written in sorted fashion where the first element has the lowest compute time.

## Parameters

### handle

*Input.* Handle to a previously created cuDNN context.

### rnnDesc

*Input.* A previously initialized RNN descriptor.

### seqLength

*Input.* Number of iterations to unroll over. The value of this **seqLength** must not exceed the value that was used in **cudaGetRNNWorkspaceSize()** function for querying the workspace size required to execute the RNN.

### xDesc

*Input.* An array of fully packed tensor descriptors describing the input to each recurrent iteration (one descriptor per iteration). The first dimension (batch size) of the tensors may decrease from element **n** to element **n+1** but may not increase. Each tensor descriptor must have the same second dimension (vector length).

### x

*Input.* Data pointer to GPU memory associated with the tensor descriptors in the array **xDesc**. The data are expected to be packed contiguously with the first element of iteration **n+1** following directly from the last element of iteration **n**.

### hxDesc

*Input.* A fully packed tensor descriptor describing the initial hidden state of the RNN. The first dimension of the tensor depends on the **direction** argument passed to the **cudaSetRNNDescriptor** call used to initialize **rnnDesc**:

- ▶ If **direction** is **CUDNN\_UNIDIRECTIONAL** the first dimension should match the **numLayers** argument passed to **cudaSetRNNDescriptor**.
- ▶ If **direction** is **CUDNN\_BIDIRECTIONAL** the first dimension should match double the **numLayers** argument passed to **cudaSetRNNDescriptor**.

The second dimension must match the first dimension of the tensors described in **xDesc**. The third dimension must match the **hiddenSize** argument passed to the **cudaSetRNNDescriptor** call used to initialize **rnnDesc**. The tensor must be fully packed.

### hx

*Input.* Data pointer to GPU memory associated with the tensor descriptor **hxDesc**. If a NULL pointer is passed, the initial hidden state of the network will be initialized to zero.

**cxDesc**

*Input.* A fully packed tensor descriptor describing the initial cell state for LSTM networks. The first dimension of the tensor depends on the **direction** argument passed to the **cudaSetRNNDescriptor** call used to initialize **rnnDesc**:

- ▶ If **direction** is **CUDNN\_UNIDIRECTIONAL** the first dimension should match the **numLayers** argument passed to **cudaSetRNNDescriptor**.
- ▶ If **direction** is **CUDNN\_BIDIRECTIONAL** the first dimension should match double the **numLayers** argument passed to **cudaSetRNNDescriptor**.

The second dimension must match the first dimension of the tensors described in **xDesc**. The third dimension must match the **hiddenSize** argument passed to the **cudaSetRNNDescriptor** call used to initialize **rnnDesc**. The tensor must be fully packed.

**cx**

*Input.* Data pointer to GPU memory associated with the tensor descriptor **cxDesc**. If a NULL pointer is passed, the initial cell state of the network will be initialized to zero.

**wDesc**

*Input.* Handle to a previously initialized filter descriptor describing the weights for the RNN.

**w**

*Input.* Data pointer to GPU memory associated with the filter descriptor **wDesc**.

**yDesc**

*Input.* An array of fully packed tensor descriptors describing the output from each recurrent iteration (one descriptor per iteration). The second dimension of the tensor depends on the **direction** argument passed to the **cudaSetRNNDescriptor** call used to initialize **rnnDesc**:

- ▶ If **direction** is **CUDNN\_UNIDIRECTIONAL** the second dimension should match the **hiddenSize** argument passed to **cudaSetRNNDescriptor**.
- ▶ If **direction** is **CUDNN\_BIDIRECTIONAL** the second dimension should match double the **hiddenSize** argument passed to **cudaSetRNNDescriptor**.

The first dimension of the tensor **n** must match the first dimension of the tensor **n** in **xDesc**.

**y**

*Output.* Data pointer to GPU memory associated with the output tensor descriptor **yDesc**. The data are expected to be packed contiguously with the first element of iteration  $n+1$  following directly from the last element of iteration  $n$ .

**hyDesc**

*Input.* A fully packed tensor descriptor describing the final hidden state of the RNN. The first dimension of the tensor depends on the **direction** argument passed to the **cudaSetRNNDescriptor** call used to initialize **rnnDesc**:

- ▶ If **direction** is **CUDNN\_UNIDIRECTIONAL** the first dimension should match the **numLayers** argument passed to **cudaSetRNNDescriptor**.



- ▶ If **direction** is **CUDNN\_BIDIRECTIONAL** the first dimension should match double the **numLayers** argument passed to **cudaSetRNNDescriptor**.

The second dimension must match the first dimension of the tensors described in **xDesc**. The third dimension must match the **hiddenSize** argument passed to the **cudaSetRNNDescriptor** call used to initialize **rnnDesc**. The tensor must be fully packed.

### hy

*Output.* Data pointer to GPU memory associated with the tensor descriptor **hyDesc**. If a NULL pointer is passed, the final hidden state of the network will not be saved.

### cyDesc

*Input.* A fully packed tensor descriptor describing the final cell state for LSTM networks. The first dimension of the tensor depends on the **direction** argument passed to the **cudaSetRNNDescriptor** call used to initialize **rnnDesc**:

- ▶ If **direction** is **CUDNN\_UNIDIRECTIONAL** the first dimension should match the **numLayers** argument passed to **cudaSetRNNDescriptor**.
- ▶ If **direction** is **CUDNN\_BIDIRECTIONAL** the first dimension should match double the **numLayers** argument passed to **cudaSetRNNDescriptor**.

The second dimension must match the first dimension of the tensors described in **xDesc**. The third dimension must match the **hiddenSize** argument passed to the **cudaSetRNNDescriptor** call used to initialize **rnnDesc**. The tensor must be fully packed.

### cy

*Output.* Data pointer to GPU memory associated with the tensor descriptor **cyDesc**. If a NULL pointer is passed, the final cell state of the network will be not be saved.

### findIntensity

*Input.* This input was previously unused in versions prior to 7.2.0. It is used in cuDNN 7.2.0 and later versions to control the overall runtime of the RNN find algorithms, by selecting the percentage of a large Cartesian product space to be searched.

- ▶ Setting **findIntensity** within the range (0,1.] will set a percentage of the entire RNN search space to search. When **findIntensity** is set to 1.0, a full search is performed over all RNN parameters.
- ▶ When **findIntensity** is set to 0.0f, a quick, minimal search is performed. This setting has the best runtime. However, in this case the parameters returned by this function will not correspond to the best performance of the algorithm; a longer search might discover better parameters. This option will execute up to three instances of the configured RNN problem. Runtime will vary proportionally to RNN problem size, as it will in the other cases, hence no guarantee of an explicit time bound can be given.
- ▶ Setting **findIntensity** within the range [-1.,0) sets a percentage of a reduced Cartesian product space to be searched. This reduced searched space has been heuristically selected to have good performance. The setting of -1.0 represents a full search over this reduced search space.

- ▶ Values outside the range [-1,1] are truncated to the range [-1,1], and then interpreted as per the above.
- ▶ Setting **findIntensity** to 1.0 in cuDNN 7.2 and later versions is equivalent to the behavior of this function in versions prior to cuDNN 7.2.0.
- ▶ This function times the single RNN executions over large parameter spaces--one execution per parameter combination. The times returned by this function are latencies.

### **requestedAlgoCount**

*Input.* The maximum number of elements to be stored in perfResults.

### **returnedAlgoCount**

*Output.* The number of output elements stored in perfResults.

### **perfResults**

*Output.* A user-allocated array to store performance metrics sorted ascending by compute time.

### **workspace**

*Input.* Data pointer to GPU memory to be used as a workspace for this call.

### **workspaceSizeInBytes**

*Input.* Specifies the size in bytes of the provided **workspace**.

### **Returns**

#### **CUDNN\_STATUS\_SUCCESS**

The function launched successfully.

#### **CUDNN\_STATUS\_NOT\_SUPPORTED**

The function does not support the provided configuration.

#### **CUDNN\_STATUS\_BAD\_PARAM**

At least one of the following conditions are met:

- ▶ The descriptor **rnnDesc** is invalid.
- ▶ At least one of the descriptors **hxDesc**, **cxDesc**, **wDesc**, **hyDesc**, **cyDesc** or one of the descriptors in **xDesc**, **yDesc** is invalid.
- ▶ The descriptors in one of **xDesc**, **hxDesc**, **cxDesc**, **wDesc**, **yDesc**, **hyDesc**, **cyDesc** have incorrect strides or dimensions.
- ▶ **workspaceSizeInBytes** is too small.

#### **CUDNN\_STATUS\_EXECUTION\_FAILED**

The function failed to launch on the GPU.

#### **CUDNN\_STATUS\_ALLOC\_FAILED**

The function was unable to allocate memory.

## 4.77. cudnnFindRNNForwardTrainingAlgorithmEx

```

cudnnStatus_t cudnnFindRNNForwardTrainingAlgorithmEx(
    cudnnHandle_t          handle,
    const cudnnRNNDescriptor_t  rnnDesc,
    const int              seqLength,
    const cudnnTensorDescriptor_t *xDesc,
    const void             *x,
    const cudnnTensorDescriptor_t hxDesc,
    const void             *hx,
    const cudnnTensorDescriptor_t cxDesc,
    const void             *cx,
    const cudnnFilterDescriptor_t wDesc,
    const void             *w,
    const cudnnTensorDescriptor_t *yDesc,
    void                  *y,
    const cudnnTensorDescriptor_t hyDesc,
    void                  *hy,
    const cudnnTensorDescriptor_t cyDesc,
    void                  *cy,
    const float            findIntensity,
    const int              requestedAlgoCount,
    int                    *returnedAlgoCount,
    cudnnAlgorithmPerformance_t *perfResults,
    void                   *workspace,
    size_t                 workspaceSizeInBytes,
    void                   *reserveSpace,
    size_t                 reserveSpaceSizeInBytes)

```

(New for 7.1)

This function attempts all available cuDNN algorithms for **cudnnRNNForwardTraining**, using user-allocated GPU memory. It outputs the parameters that influence the performance of the algorithm to a user-allocated array of **cudnnAlgorithmPerformance\_t**. These parameter metrics are written in sorted fashion where the first element has the lowest compute time.

### Parameters

#### handle

*Input.* Handle to a previously created cuDNN context.

#### rnnDesc

*Input.* A previously initialized RNN descriptor.

#### xDesc

*Input.* An array of fully packed tensor descriptors describing the input to each recurrent iteration (one descriptor per iteration). The first dimension (batch size) of the tensors may decrease from element **n** to element **n+1** but may not increase. Each tensor descriptor must have the same second dimension (vector length).

#### seqLength

*Input.* Number of iterations to unroll over. The value of this **seqLength** must not exceed the value that was used in **cudnnGetRNNWorkspaceSize()** function for querying the workspace size required to execute the RNN.

**x**

*Input.* Data pointer to GPU memory associated with the tensor descriptors in the array **xDesc**.

**hxDesc**

*Input.* A fully packed tensor descriptor describing the initial hidden state of the RNN. The first dimension of the tensor depends on the **direction** argument passed to the **cudaSetRNNDescriptor** call used to initialize **rnnDesc**:

- ▶ If **direction** is **CUDNN\_UNIDIRECTIONAL** the first dimension should match the **numLayers** argument passed to **cudaSetRNNDescriptor**.
- ▶ If **direction** is **CUDNN\_BIDIRECTIONAL** the first dimension should match double the **numLayers** argument passed to **cudaSetRNNDescriptor**.

The second dimension must match the first dimension of the tensors described in **xDesc**. The third dimension must match the **hiddenSize** argument passed to the **cudaSetRNNDescriptor** call used to initialize **rnnDesc**. The tensor must be fully packed.

**hx**

*Input.* Data pointer to GPU memory associated with the tensor descriptor **hxDesc**. If a NULL pointer is passed, the initial hidden state of the network will be initialized to zero.

**cxDesc**

*Input.* A fully packed tensor descriptor describing the initial cell state for LSTM networks. The first dimension of the tensor depends on the **direction** argument passed to the **cudaSetRNNDescriptor** call used to initialize **rnnDesc**:

- ▶ If **direction** is **CUDNN\_UNIDIRECTIONAL** the first dimension should match the **numLayers** argument passed to **cudaSetRNNDescriptor**.
- ▶ If **direction** is **CUDNN\_BIDIRECTIONAL** the first dimension should match double the **numLayers** argument passed to **cudaSetRNNDescriptor**.

The second dimension must match the first dimension of the tensors described in **xDesc**. The third dimension must match the **hiddenSize** argument passed to the **cudaSetRNNDescriptor** call used to initialize **rnnDesc**. The tensor must be fully packed.

**cx**

*Input.* Data pointer to GPU memory associated with the tensor descriptor **cxDesc**. If a NULL pointer is passed, the initial cell state of the network will be initialized to zero.

**wDesc**

*Input.* Handle to a previously initialized filter descriptor describing the weights for the RNN.

**w**

*Input.* Data pointer to GPU memory associated with the filter descriptor **wDesc**.

**yDesc**

*Input.* An array of fully packed tensor descriptors describing the output from each recurrent iteration (one descriptor per iteration). The second dimension of the tensor depends on the **direction** argument passed to the **cudaSetRNNDescriptor** call used to initialize **rnnDesc**:

- ▶ If **direction** is **CUDNN\_UNIDIRECTIONAL** the second dimension should match the **hiddenSize** argument passed to **cudaSetRNNDescriptor**.
- ▶ If **direction** is **CUDNN\_BIDIRECTIONAL** the second dimension should match double the **hiddenSize** argument passed to **cudaSetRNNDescriptor**.

The first dimension of the tensor **n** must match the first dimension of the tensor **n** in **xDesc**.

**y**

*Output.* Data pointer to GPU memory associated with the output tensor descriptor **yDesc**.

**hyDesc**

*Input.* A fully packed tensor descriptor describing the final hidden state of the RNN. The first dimension of the tensor depends on the **direction** argument passed to the **cudaSetRNNDescriptor** call used to initialize **rnnDesc**:

- ▶ If **direction** is **CUDNN\_UNIDIRECTIONAL** the first dimension should match the **numLayers** argument passed to **cudaSetRNNDescriptor**.
- ▶ If **direction** is **CUDNN\_BIDIRECTIONAL** the first dimension should match double the **numLayers** argument passed to **cudaSetRNNDescriptor**.

The second dimension must match the first dimension of the tensors described in **xDesc**. The third dimension must match the **hiddenSize** argument passed to the **cudaSetRNNDescriptor** call used to initialize **rnnDesc**. The tensor must be fully packed.

**hy**

*Output.* Data pointer to GPU memory associated with the tensor descriptor **hyDesc**. If a NULL pointer is passed, the final hidden state of the network will not be saved.

**cyDesc**

*Input.* A fully packed tensor descriptor describing the final cell state for LSTM networks. The first dimension of the tensor depends on the **direction** argument passed to the **cudaSetRNNDescriptor** call used to initialize **rnnDesc**:

- ▶ If **direction** is **CUDNN\_UNIDIRECTIONAL** the first dimension should match the **numLayers** argument passed to **cudaSetRNNDescriptor**.
- ▶ If **direction** is **CUDNN\_BIDIRECTIONAL** the first dimension should match double the **numLayers** argument passed to **cudaSetRNNDescriptor**.

The second dimension must match the first dimension of the tensors described in **xDesc**. The third dimension must match the **hiddenSize** argument passed to the **cudaSetRNNDescriptor** call used to initialize **rnnDesc**. The tensor must be fully packed.

**cy**

*Output.* Data pointer to GPU memory associated with the tensor descriptor **cyDesc**. If a NULL pointer is passed, the final cell state of the network will not be saved.

**findIntensity**

*Input.* This input was previously unused in versions prior to 7.2.0. It is used in cuDNN 7.2.0 and later versions to control the overall runtime of the RNN find algorithms, by selecting the percentage of a large Cartesian product space to be searched.

- ▶ Setting **findIntensity** within the range (0,1.] will set a percentage of the entire RNN search space to search. When **findIntensity** is set to 1.0, a full search is performed over all RNN parameters.
- ▶ When **findIntensity** is set to 0.0f, a quick, minimal search is performed. This setting has the best runtime. However, in this case the parameters returned by this function will not correspond to the best performance of the algorithm; a longer search might discover better parameters. This option will execute up to three instances of the configured RNN problem. Runtime will vary proportionally to RNN problem size, as it will in the other cases, hence no guarantee of an explicit time bound can be given.
- ▶ Setting **findIntensity** within the range [-1.,0) sets a percentage of a reduced Cartesian product space to be searched. This reduced searched space has been heuristically selected to have good performance. The setting of -1.0 represents a full search over this reduced search space.
- ▶ Values outside the range [-1,1] are truncated to the range [-1,1], and then interpreted as per the above.
- ▶ Setting **findIntensity** to 1.0 in cuDNN 7.2 and later versions is equivalent to the behavior of this function in versions prior to cuDNN 7.2.0.
- ▶ This function times the single RNN executions over large parameter spaces--one execution per parameter combination. The times returned by this function are latencies.

**requestedAlgoCount**

*Input.* The maximum number of elements to be stored in perfResults.

**returnedAlgoCount**

*Output.* The number of output elements stored in perfResults.

**perfResults**

*Output.* A user-allocated array to store performance metrics sorted ascending by compute time.

**workspace**

*Input.* Data pointer to GPU memory to be used as a workspace for this call.

**workspaceSizeInBytes**

*Input.* Specifies the size in bytes of the provided **workspace**.

**reserveSpace**

*Input/Output.* Data pointer to GPU memory to be used as a reserve space for this call.

**reserveSpaceSizeInBytes**

*Input.* Specifies the size in bytes of the provided **reserveSpace**

The possible error values returned by this function and their meanings are listed below.

**Returns****CUDNN\_STATUS\_SUCCESS**

The function launched successfully.

**CUDNN\_STATUS\_BAD\_PARAM**

At least one of the following conditions are met:

- ▶ The descriptor **rnnDesc** is invalid.
- ▶ At least one of the descriptors **hxDesc**, **cxDesc**, **wDesc**, **hyDesc**, **cyDesc** or one of the descriptors in **xDesc**, **yDesc** is invalid.
- ▶ The descriptors in one of **xDesc**, **hxDesc**, **cxDesc**, **wDesc**, **yDesc**, **hyDesc**, **cyDesc** have incorrect strides or dimensions.
- ▶ **workspaceSizeInBytes** is too small.
- ▶ **reserveSpaceSizeInBytes** is too small.

**CUDNN\_STATUS\_EXECUTION\_FAILED**

The function failed to launch on the GPU.

**CUDNN\_STATUS\_ALLOC\_FAILED**

The function was unable to allocate memory.

## 4.78. cudnnFusedOpsExecute

```

cudnnStatus_t cudnnFusedOpsExecute(
    cudnnHandle_t handle,
    const cudnnFusedOpsPlan_t plan,
    cudnnFusedOpsVariantParamPack_t varPack);

```

This function executes the sequence of `cudnnFusedOps` operations.

**Parameters:**

Parameter	Input / Output	Description
handle	Input	Pointer to the cuDNN library context.
plan	Input	Pointer to a previously-created and initialized plan descriptor.
varPack	Input	Pointer to the descriptor to the variant parameters pack.

**Returns:**

Return Value	Description
CUDNN_STATUS_BAD_PARAM	If the type of <code>cudnnFusedOps_t</code> in the plan descriptor is unsupported.

## 4.79. cudnnGetActivationDescriptor

```

cudnnStatus_t cudnnGetActivationDescriptor(
    const cudnnActivationDescriptor_t  activationDesc,
    cudnnActivationMode_t              *mode,
    cudnnNanPropagation_t              *reluNanOpt,
    double                              *coef)

```

This function queries a previously initialized generic activation descriptor object.

### Parameters

#### activationDesc

*Input.* Handle to a previously created activation descriptor.

#### mode

*Output.* Enumerant to specify the activation mode.

#### reluNanOpt

*Output.* Enumerant to specify the **Nan** propagation mode.

#### coef

*Output.* Floating point number to specify the clipping threshold when the activation mode is set to `CUDNN_ACTIVATION_CLIPPED_RELU` or to specify the alpha coefficient when the activation mode is set to `CUDNN_ACTIVATION_ELU`.

The possible error values returned by this function and their meanings are listed below.

### Returns

#### CUDNN\_STATUS\_SUCCESS

The object was queried successfully.

## 4.80. cudnnGetAlgorithmDescriptor

```

cudnnStatus_t cudnnGetAlgorithmDescriptor(
    const cudnnAlgorithmDescriptor_t  algoDesc,
    cudnnAlgorithm_t                  *algorithm)

```

### (New for 7.1)

This function queries a previously initialized generic algorithm descriptor object.

### Parameters

#### algorithmDesc

*Input.* Handle to a previously created algorithm descriptor.

#### algorithm

*Input.* Struct to specify the algorithm.

### Returns



**CUDNN\_STATUS\_SUCCESS**

The object was queried successfully.

## 4.81. cudnnGetAlgorithmPerformance

```

cudnnStatus_t cudnnGetAlgorithmPerformance(
    const cudnnAlgorithmPerformance_t  algoPerf,
    cudnnAlgorithmDescriptor_t*        algoDesc,
    cudnnStatus_t*                     status,
    float*                              time,
    size_t*                             memory)

```

**(New for 7.1)**

This function queries a previously initialized generic algorithm performance object.

**Parameters****algoPerf**

*Input/Output.* Handle to a previously created algorithm performance object.

**algoDesc**

*Output.* The algorithm descriptor which the performance results describe.

**status**

*Output.* The cudnn status returned from running the algoDesc algorithm.

**timecoef**

*Output.* The GPU time spent running the algoDesc algorithm.

**memory**

*Output.* The GPU memory needed to run the algoDesc algorithm.

**Returns****CUDNN\_STATUS\_SUCCESS**

The object was queried successfully.

## 4.82. cudnnGetAlgorithmSpaceSize

```

cudnnStatus_t cudnnGetAlgorithmSpaceSize(
    cudnnHandle_t      handle,
    cudnnAlgorithmDescriptor_t  algoDesc,
    size_t*            algoSpaceSizeInBytes)

```

**(New for 7.1)**

This function queries for the amount of host memory needed to call **cudnnSaveAlgorithm**, much like the “get workspace size” functions query for the amount of device memory needed.

**Parameters**

**handle**

*Input.* Handle to a previously created cuDNN context.

**algoDesc**

*Input.* A previously created algorithm descriptor.

**algoSpaceSizeInBytes**

*Output.* Amount of host memory needed as workspace to be able to save the metadata from the specified **algoDesc**.

**Returns****CUDNN\_STATUS\_SUCCESS**

The function launched successfully.

**CUDNN\_STATUS\_BAD\_PARAM**

At least one of the arguments is null.

## 4.83. cudnnGetAttnDescriptor

```

cudnnStatus_t cudnnGetAttnDescriptor(
    cudnnAttnDescriptor_t attnDesc,
    cudnnAttnQueryMap_t *queryMap,
    int *nHeads,
    double *smScaler,
    cudnnDataType_t *dataType,
    cudnnDataType_t *computePrec,
    cudnnMathType_t *mathType,
    cudnnDropoutDescriptor_t *attnDropoutDesc,
    cudnnDropoutDescriptor_t *postDropoutDesc,
    int *qSize,
    int *kSize,
    int *vSize,
    int *qProjSize,
    int *kProjSize,
    int *vProjSize,
    int *oProjSize,
    int *qoMaxSeqLength,
    int *kvMaxSeqLength,
    int *maxBatchSize,
    int *maxBeamSize);

```

This function retrieves the values from a previously initialized attention descriptor.

**Parameters:**

Parameter	Input / Output	Description
attnDesc	Input	Attention descriptor whose values are to be retrieved.
queryMap	Output	Query mapping mode.
nHeads	Output	Number of attention heads.
smScaler	Output	Softmax smoothing, or sharpening, coefficient.

dataType	Output	Data type for Q,K,V inputs, weights, and the output.
computePrec	Output	Compute data type (precision).
mathType	Output	The Tensor Core Operations settings.
attnDropoutDesc	Output	Dropout descriptor for the dropout at the attention layer.
postDropoutDesc	Output	Dropout descriptor for the dropout at the output.
qSize, kSize, vSize	Output	Hidden size of Q, K, and V input sequence data.
qProjSize, kProjSize, vProjSize	Output	Hidden size of projected Q, K and V sequence data; 0 if no projection.
oProjSize	Output	Output projection size.
qoMaxSeqLength	Output	Largest sequence length allowed in sequence data Q and O.
kvMaxSeqLength	Output	Largest sequence length allowed in sequence data K and V.
maxBatchSize	Output	Largest batch size allowed in sequence data.
maxBeamSize	Output	Largest beam size allowed in sequence data.

**Returns:**

Return Value	Description
CUDNN_STATUS_BAD_PARAM	<code>attDesc</code> is a NULL pointer.
CUDNN_STATUS_SUCCESS	The attention descriptor structure values are retrieved successfully.

## 4.84. cudnnBatchNormalizationBackwardExWorkspaceSize

```

cudnnStatus_t cudnnGetBatchNormalizationBackwardExWorkspaceSize (
    cudnnHandle_t          handle,
    cudnnBatchNormMode_t  mode,
    cudnnBatchNormOps_t   bnOps,
    const cudnnTensorDescriptor_t xDesc,
    const cudnnTensorDescriptor_t yDesc,
    const cudnnTensorDescriptor_t dyDesc,
    const cudnnTensorDescriptor_t dzDesc,
    const cudnnTensorDescriptor_t dxDesc,
    const cudnnTensorDescriptor_t dBnScaleBiasDesc,
    const cudnnActivationDescriptor_t activationDesc,
    size_t                 *sizeInBytes);

```

This function returns the amount of GPU memory workspace the user should allocate to be able to call `cudnnGetBatchNormalizationBackwardEx()` function for the specified `bnOps` input setting. The workspace allocated will then be passed to the function `cudnnGetBatchNormalizationBackwardEx()`.

**Parameters****handle**

*Input.* Handle to a previously created cuDNN library descriptor. See [cudnnHandle\\_t](#).

**mode**

*Input.* Mode of operation (spatial or per-activation). See [cudnnBatchNormMode\\_t](#).

**bnOps**

*Input.* Mode of operation for the fast NHWC kernel. See [cudnnBatchNormOps\\_t](#). This input can be used to set this function to perform either only the batch normalization, or batch normalization followed by activation, or batch normalization followed by element-wise addition and then activation.

**xDesc, yDesc, dyDesc, dzDesc, dxDesc**

Tensor descriptors and pointers in the device memory for the layer's **x** data, back propagated differential **dy** (inputs), the optional **y** input data, the optional **dz** output, and the **dx** output, which is the resulting differential with respect to **x**. See [cudnnTensorDescriptor\\_t](#).

**dBnScaleBiasDesc**

*Input.* Shared tensor descriptor for the following six tensors: **bnScaleData**, **bnBiasData**, **dBnScaleData**, **dBnBiasData**, **savedMean**, and **savedInvVariance**. This is the shared tensor descriptor desc for the secondary tensor that was derived by [cudnnDeriveBNTensorDescriptor\(\)](#). The dimensions for this tensor descriptor are dependent on normalization mode. Note: The data type of this tensor descriptor must be 'float' for FP16 and FP32 input tensors, and 'double' for FP64 input tensors.

**activationDesc**

*Input.* Tensor descriptor for the activation operation.

**\*sizeInBytes**

*Output.* Amount of GPU memory required for the workspace, as determined by this function, to be able to execute the [cudnnGetBatchNormalizationBackwardEx\(\)](#) function with the specified **bnOps** input setting.

Possible error values returned by this function and their meanings are listed below.

**Returns****CUDNN\_STATUS\_SUCCESS**

The computation was performed successfully.

**CUDNN\_STATUS\_NOT\_SUPPORTED**

The function does not support the provided configuration.

**CUDNN\_STATUS\_BAD\_PARAM**

At least one of the following conditions are met:

- ▶ Number of **xDesc** or **yDesc** or **dxDesc** tensor descriptor dimensions is not within the range of [4,5] (only 4D and 5D tensors are supported.)

- ▶ **dBnScaleBiasDesc** dimensions not 1xCx1x1 for 4D and 1xCx1x1x1 for 5D for spatial, and are not 1xCxHxW for 4D and 1xCxDxHxW for 5D for per-activation mode.
- ▶ Dimensions or data types mismatch for any pair of **xDesc**, **dyDesc**, **dxDesc**

## 4.85. cudnnBatchNormalizationForwardTrainingExWorkspace

```

cudnnStatus_t cudnnGetBatchNormalizationForwardTrainingExWorkspaceSize(
    cudnnHandle_t             handle,
    cudnnBatchNormMode_t     mode,
    cudnnBatchNormOps_t      bnOps,
    const cudnnTensorDescriptor_t xDesc,
    const cudnnTensorDescriptor_t zDesc,
    const cudnnTensorDescriptor_t yDesc,
    const cudnnTensorDescriptor_t bnScaleBiasMeanVarDesc,
    const cudnnActivationDescriptor_t activationDesc,
    size_t                    *sizeInBytes);

```

This function returns the amount of GPU memory workspace the user should allocate to be able to call `cudnnGetBatchNormalizationForwardTrainingEx()` function for the specified **bnOps** input setting. The workspace allocated should then be passed by the user to the function `cudnnGetBatchNormalizationForwardTrainingEx()`.

### Parameters

#### handle

*Input.* Handle to a previously created cuDNN library descriptor. See `cudnnHandle_t`.

#### mode

*Input.* Mode of operation (spatial or per-activation). See `cudnnBatchNormMode_t`.

#### bnOps

*Input.* Mode of operation for the fast NHWC kernel. See `cudnnBatchNormOps_t`.

This input can be used to set this function to perform either only the batch normalization, or batch normalization followed by activation, or batch normalization followed by element-wise addition and then activation.

#### xDesc, zDesc, yDesc

Tensor descriptors and pointers in the device memory for the layer's **x** data, the optional **z** input data, and the **y** output. See `cudnnTensorDescriptor_t`.

#### bnScaleBiasMeanVarDesc

*Input.* Shared tensor descriptor for the following six tensors: **bnScaleData**, **bnBiasData**, **dBnScaleData**, **dBnBiasData**, **savedMean**, and **savedInvVariance**. This is the shared tensor descriptor desc for the secondary tensor that was derived by `cudnnDeriveBNTensorDescriptor()`. The dimensions for this tensor descriptor are dependent on normalization mode. Note: The data type of this tensor descriptor must be 'float' for FP16 and FP32 input tensors, and 'double' for FP64 input tensors.

#### activationDesc

*Input.* Tensor descriptor for the activation operation. When the **bnOps** input is set to either `CUDNN_BATCHNORM_OPS_BN_ACTIVATION` or `CUDNN_BATCHNORM_OPS_BN_ADD_ACTIVATION` then this activation is used.

**\*sizeInBytes**

*Output.* Amount of GPU memory required for the workspace, as determined by this function, to be able to execute the `cudaGetBatchNormalizationForwardTrainingEx()` function with the specified `bnOps` input setting.

**Returns****CUDNN\_STATUS\_SUCCESS**

The computation was performed successfully.

**CUDNN\_STATUS\_NOT\_SUPPORTED**

The function does not support the provided configuration.

**CUDNN\_STATUS\_BAD\_PARAM**

At least one of the following conditions are met:

- ▶ Number of `xDesc` or `yDesc` or `dxDesc` tensor descriptor dimensions is not within the range of [4,5] (only 4D and 5D tensors are supported.)
- ▶ `dBnScaleBiasDesc` dimensions not 1xCx1x1 for 4D and 1xCx1x1x1 for 5D for spatial, and are not 1xCxHxW for 4D and 1xCxDxHxW for 5D for per-activation mode.
- ▶ Dimensions or data types mismatch for `xDesc`, `yDesc`.

## 4.86. `cudaGetBatchNormalizationTrainingExReserveSpaceSize`

```

cudaStatus_t cudaGetBatchNormalizationTrainingExReserveSpaceSize (
    cudaHandle_t          handle,
    cudaBatchNormMode_t   mode,
    cudaBatchNormOps_t    bnOps,
    const cudaActivationDescriptor_t activationDesc,
    const cudaTensorDescriptor_t xDesc,
    size_t                *sizeInBytes);

```

This function returns the amount of reserve GPU memory workspace the user should allocate for the batch normalization operation, for the specified `bnOps` input setting. In contrast to the `workspace`, the reserved space should be preserved between the forward and backward calls, and the data should not be altered.

**Parameters****handle**

*Input.* Handle to a previously created cuDNN library descriptor. See `cudaHandle_t`.

**mode**

*Input.* Mode of operation (spatial or per-activation). See `cudaBatchNormMode_t`.

**bnOps**

*Input.* Mode of operation for the fast NHWC kernel. See `cudaBatchNormOps_t`.

This input can be used to set this function to perform either only the batch normalization, or batch normalization followed by activation, or batch normalization followed by element-wise addition and then activation.

**xDesc**

Tensor descriptors for the layer's x data. See [cudnnTensorDescriptor\\_t](#).

**activationDesc**

*Input.* Tensor descriptor for the activation operation.

**\*sizeInBytes**

*Output.* Amount of GPU memory reserved.

Possible error values returned by this function and their meanings are listed below.

**Returns****CUDNN\_STATUS\_SUCCESS**

The computation was performed successfully.

**CUDNN\_STATUS\_NOT\_SUPPORTED**

The function does not support the provided configuration.

**CUDNN\_STATUS\_BAD\_PARAM**

At least one of the following conditions are met:

- ▶ The **xDesc** tensor descriptor dimension is not within the [4,5] range (only 4D and 5D tensors are supported.)

## 4.87. cudnnGetCallback

```

cudnnStatus_t cudnnGetCallback(
    unsigned      mask,
    void          **udata,
    cudnnCallback_t  fptr)

```

**(New for 7.1)**

This function queries the internal states of cuDNN error reporting functionality.

**Parameters****mask**

*Output.* Pointer to the address where the current internal error reporting message bit mask will be outputted.

**udata**

*Output.* Pointer to the address where the current internally stored udata address will be stored.

**fptr**

*Output.* Pointer to the address where the current internally stored callback function pointer will be stored. When the built-in default callback function is used, NULL will be outputted.

**Returns****CUDNN\_STATUS\_SUCCESS**

The function launched successfully.

**CUDNN\_STATUS\_BAD\_PARAM**

If any of the input parameters are NULL.

## 4.88. cudnnGetConvolution2dDescriptor

```

cudnnStatus_t cudnnGetConvolution2dDescriptor(
    const cudnnConvolutionDescriptor_t convDesc,
    int *pad_h,
    int *pad_w,
    int *u,
    int *v,
    int *dilation_h,
    int *dilation_w,
    cudnnConvolutionMode_t mode,
    cudnnDataType_t computeType)

```

This function queries a previously initialized 2D convolution descriptor object.

### Parameters

#### **convDesc**

*Input/Output.* Handle to a previously created convolution descriptor.

#### **pad\_h**

*Output.* zero-padding height: number of rows of zeros implicitly concatenated onto the top and onto the bottom of input images.

#### **pad\_w**

*Output.* zero-padding width: number of columns of zeros implicitly concatenated onto the left and onto the right of input images.

#### **u**

*Output.* Vertical filter stride.

#### **v**

*Output.* Horizontal filter stride.

#### **dilation\_h**

*Output.* Filter height dilation.

#### **dilation\_w**

*Output.* Filter width dilation.

#### **mode**

*Output.* Convolution mode.

#### **computeType**

*Output.* Compute precision.

The possible error values returned by this function and their meanings are listed below.

### Returns



**CUDNN\_STATUS\_SUCCESS**

The operation was successful.

**CUDNN\_STATUS\_BAD\_PARAM**

The parameter **convDesc** is nil.

## 4.89. cudnnGetConvolution2dForwardOutputDim

```

cudnnStatus_t cudnnGetConvolution2dForwardOutputDim(
    const cudnnConvolutionDescriptor_t convDesc,
    const cudnnTensorDescriptor_t inputTensorDesc,
    const cudnnFilterDescriptor_t filterDesc,
    int *n,
    int *c,
    int *h,
    int *w)

```

This function returns the dimensions of the resulting 4D tensor of a 2D convolution, given the convolution descriptor, the input tensor descriptor and the filter descriptor. This function can help to setup the output tensor and allocate the proper amount of memory prior to launch the actual convolution.

Each dimension **h** and **w** of the output images is computed as followed:

```

outputDim = 1 + ( inputDim + 2*pad - ((filterDim-1)*dilation)+1 ) /
convolutionStride;

```



The dimensions provided by this routine must be strictly respected when calling **cudnnConvolutionForward()** or **cudnnConvolutionBackwardBias()**. Providing a smaller or larger output tensor is not supported by the convolution routines.

### Parameters

#### **convDesc**

*Input.* Handle to a previously created convolution descriptor.

#### **inputTensorDesc**

*Input.* Handle to a previously initialized tensor descriptor.

#### **filterDesc**

*Input.* Handle to a previously initialized filter descriptor.

#### **n**

*Output.* Number of output images.

#### **c**

*Output.* Number of output feature maps per image.

#### **h**

*Output.* Height of each output feature map.

**w**

*Output.* Width of each output feature map.

The possible error values returned by this function and their meanings are listed below.

### Returns

#### **CUDNN\_STATUS\_BAD\_PARAM**

One or more of the descriptors has not been created correctly or there is a mismatch between the feature maps of **inputTensorDesc** and **filterDesc**.

#### **CUDNN\_STATUS\_SUCCESS**

The object was set successfully.

## 4.90. cudnnGetConvolutionBackwardDataAlgorithm

```

cudnnStatus_t cudnnGetConvolutionBackwardDataAlgorithm(
    cudnnHandle_t          handle,
    const cudnnFilterDescriptor_t  wDesc,
    const cudnnTensorDescriptor_t  dyDesc,
    const cudnnConvolutionDescriptor_t  convDesc,
    const cudnnTensorDescriptor_t  dxDesc,
    cudnnConvolutionBwdDataPreference_t  preference,
    size_t                 memoryLimitInBytes,
    cudnnConvolutionBwdDataAlgo_t  *algo)

```

This function serves as a heuristic for obtaining the best suited algorithm for **cudnnConvolutionBackwardData** for the given layer specifications. Based on the input preference, this function will either return the fastest algorithm or the fastest algorithm within a given memory limit. For an exhaustive search for the fastest algorithm, please use **cudnnFindConvolutionBackwardDataAlgorithm**.

### Parameters

#### **handle**

*Input.* Handle to a previously created cuDNN context.

#### **wDesc**

*Input.* Handle to a previously initialized filter descriptor.

#### **dyDesc**

*Input.* Handle to the previously initialized input differential tensor descriptor.

#### **convDesc**

*Input.* Previously initialized convolution descriptor.

#### **dxDesc**

*Input.* Handle to the previously initialized output tensor descriptor.

#### **preference**

*Input.* Enumerant to express the preference criteria in terms of memory requirement and speed.

**memoryLimitInBytes**

*Input.* It is to specify the maximum amount of GPU memory the user is willing to use as a workspace. This is currently a placeholder and is not used.

**algo**

*Output.* Enumerant that specifies which convolution algorithm should be used to compute the results according to the specified preference

The possible error values returned by this function and their meanings are listed below.

**Returns****CUDNN\_STATUS\_SUCCESS**

The query was successful.

**CUDNN\_STATUS\_BAD\_PARAM**

At least one of the following conditions are met:

- ▶ The numbers of feature maps of the input tensor and output tensor differ.
- ▶ The **dataType** of the two tensor descriptors or the filter are different.

## 4.91. cudnnGetConvolutionBackwardDataAlgorithm\_v7

```

cudnnStatus_t cudnnGetConvolutionBackwardDataAlgorithm_v7(
    cudnnHandle_t          handle,
    const cudnnFilterDescriptor_t  wDesc,
    const cudnnTensorDescriptor_t  dyDesc,
    const cudnnConvolutionDescriptor_t  convDesc,
    const cudnnTensorDescriptor_t  dxDesc,
    const int              requestedAlgoCount,
    int                    *returnedAlgoCount,
    cudnnConvolutionBwdDataAlgoPerf_t  *perfResults)

```

This function serves as a heuristic for obtaining the best suited algorithm for **cudnnConvolutionBackwardData** for the given layer specifications. This function will return all algorithms (including CUDNN\_TENSOR\_OP\_MATH and CUDNN\_DEFAULT\_MATH versions of algorithms where CUDNN\_TENSOR\_OP\_MATH may be available) sorted by expected (based on internal heuristic) relative performance with fastest being index 0 of perfResults. For an exhaustive search for the fastest algorithm, please use **cudnnFindConvolutionBackwardDataAlgorithm**. The total number of resulting algorithms can be queried through the API **cudnnGetConvolutionBackwardMaxCount()**.

**Parameters****handle**

*Input.* Handle to a previously created cuDNN context.

**wDesc**

*Input.* Handle to a previously initialized filter descriptor.

**dyDesc**

*Input.* Handle to the previously initialized input differential tensor descriptor.

**convDesc**

*Input.* Previously initialized convolution descriptor.

**dxDesc**

*Input.* Handle to the previously initialized output tensor descriptor.

**requestedAlgoCount**

*Input.* The maximum number of elements to be stored in perfResults.

**returnedAlgoCount**

*Output.* The number of output elements stored in perfResults.

**perfResults**

*Output.* A user-allocated array to store performance metrics sorted ascending by compute time.

The possible error values returned by this function and their meanings are listed below.

**Returns****CUDNN\_STATUS\_SUCCESS**

The query was successful.

**CUDNN\_STATUS\_BAD\_PARAM**

At least one of the following conditions are met:

- ▶ One of the parameters `handle`, `wDesc`, `dyDesc`, `convDesc`, `dxDesc`, `perfResults`, `returnedAlgoCount` is NULL.
- ▶ The numbers of feature maps of the input tensor and output tensor differ.
- ▶ The **dataType** of the two tensor descriptors or the filter are different.
- ▶ `requestedAlgoCount` is less than or equal to 0.

## 4.92. cudnnGetConvolutionBackwardDataAlgorithmMaxCount

```

cudnnStatus_t cudnnGetConvolutionBackwardDataAlgorithmMaxCount(
    cudnnHandle_t      handle,
    int                *count)

```

This function returns the maximum number of algorithms which can be returned from `cudnnFindConvolutionBackwardDataAlgorithm()` and `cudnnGetConvolutionForwardAlgorithm_v7()`. This is the sum of all algorithms plus the sum of all algorithms with Tensor Core operations supported for the current device.

**Parameters****handle**

*Input.* Handle to a previously created cuDNN context.

**count**

*Output.* The resulting maximum number of algorithms.

**Returns****CUDNN\_STATUS\_SUCCESS**

The function was successful.

**CUDNN\_STATUS\_BAD\_PARAM**

The provided handle is not allocated properly.

## 4.93. cudnnGetConvolutionBackwardDataWorkspaceSize

```

cudnnStatus_t cudnnGetConvolutionBackwardDataWorkspaceSize(
    cudnnHandle_t      handle,
    const cudnnFilterDescriptor_t    wDesc,
    const cudnnTensorDescriptor_t    dyDesc,
    const cudnnConvolutionDescriptor_t convDesc,
    const cudnnTensorDescriptor_t    dxDesc,
    cudnnConvolutionBwdDataAlgo_t    algo,
    size_t              *sizeInBytes)

```

This function returns the amount of GPU memory workspace the user needs to allocate to be able to call **cudnnConvolutionBackwardData** with the specified algorithm. The workspace allocated will then be passed to the routine **cudnnConvolutionBackwardData**. The specified algorithm can be the result of the call to **cudnnGetConvolutionBackwardDataAlgorithm** or can be chosen arbitrarily by the user. Note that not every algorithm is available for every configuration of the input tensor and/or every configuration of the convolution descriptor.

**Parameters****handle**

*Input.* Handle to a previously created cuDNN context.

**wDesc**

*Input.* Handle to a previously initialized filter descriptor.

**dyDesc**

*Input.* Handle to the previously initialized input differential tensor descriptor.

**convDesc**

*Input.* Previously initialized convolution descriptor.

**dxDesc**

*Input.* Handle to the previously initialized output tensor descriptor.

**algo**

*Input.* Enumerant that specifies the chosen convolution algorithm

**sizeInBytes**

*Output.* Amount of GPU memory needed as workspace to be able to execute a forward convolution with the specified **algo**

The possible error values returned by this function and their meanings are listed below.

### Returns

#### CUDNN\_STATUS\_SUCCESS

The query was successful.

#### CUDNN\_STATUS\_BAD\_PARAM

At least one of the following conditions are met:

- ▶ The numbers of feature maps of the input tensor and output tensor differ.
- ▶ The **dataType** of the two tensor descriptors or the filter are different.

#### CUDNN\_STATUS\_NOT\_SUPPORTED

The combination of the tensor descriptors, filter descriptor and convolution descriptor is not supported for the specified algorithm.

## 4.94. cudnnGetConvolutionBackwardFilterAlgorithm

```

cudnnStatus_t cudnnGetConvolutionBackwardFilterAlgorithm(
    cudnnHandle_t          handle,
    const cudnnTensorDescriptor_t  xDesc,
    const cudnnTensorDescriptor_t  dyDesc,
    const cudnnConvolutionDescriptor_t  convDesc,
    const cudnnFilterDescriptor_t   dwDesc,
    cudnnConvolutionBwdFilterPreference_t  preference,
    size_t                 memoryLimitInBytes,
    cudnnConvolutionBwdFilterAlgo_t  *algo)

```

This function serves as a heuristic for obtaining the best suited algorithm for **cudnnConvolutionBackwardFilter** for the given layer specifications. Based on the input preference, this function will either return the fastest algorithm or the fastest algorithm within a given memory limit. For an exhaustive search for the fastest algorithm, please use **cudnnFindConvolutionBackwardFilterAlgorithm**.

### Parameters

#### handle

*Input.* Handle to a previously created cuDNN context.

#### xDesc

*Input.* Handle to the previously initialized input tensor descriptor.

#### dyDesc

*Input.* Handle to the previously initialized input differential tensor descriptor.

#### convDesc

*Input.* Previously initialized convolution descriptor.

#### dwDesc

*Input.* Handle to a previously initialized filter descriptor.

**preference**

*Input.* Enumerant to express the preference criteria in terms of memory requirement and speed.

**memoryLimitInBytes**

*Input.* It is to specify the maximum amount of GPU memory the user is willing to use as a workspace. This is currently a placeholder and is not used.

**algo**

*Output.* Enumerant that specifies which convolution algorithm should be used to compute the results according to the specified preference.

The possible error values returned by this function and their meanings are listed below.

**Returns****CUDNN\_STATUS\_SUCCESS**

The query was successful.

**CUDNN\_STATUS\_BAD\_PARAM**

At least one of the following conditions are met:

- ▶ The numbers of feature maps of the input tensor and output tensor differ.
- ▶ The **dataType** of the two tensor descriptors or the filter are different.

## 4.95. cudnnGetConvolutionBackwardFilterAlgorithm\_v7

```

cudnnStatus_t cudnnGetConvolutionBackwardFilterAlgorithm_v7(
    cudnnHandle_t          handle,
    const cudnnTensorDescriptor_t  xDesc,
    const cudnnTensorDescriptor_t  dyDesc,
    const cudnnConvolutionDescriptor_t  convDesc,
    const cudnnFilterDescriptor_t   dwDesc,
    const int              requestedAlgoCount,
    int                    *returnedAlgoCount,
    cudnnConvolutionBwdFilterAlgoPerf_t  *perfResults)

```

This function serves as a heuristic for obtaining the best suited algorithm for **cudnnConvolutionBackwardFilter** for the given layer specifications. This function will return all algorithms (including CUDNN\_TENSOR\_OP\_MATH and CUDNN\_DEFAULT\_MATH versions of algorithms where CUDNN\_TENSOR\_OP\_MATH may be available) sorted by expected (based on internal heuristic) relative performance with fastest being index 0 of perfResults. For an exhaustive search for the fastest algorithm, please use **cudnnFindConvolutionBackwardFilterAlgorithm**. The total number of resulting algorithms can be queried through the API **cudnnGetConvolutionBackwardMaxCount()**.

**Parameters****handle**

*Input.* Handle to a previously created cuDNN context.

**xDesc**

*Input.* Handle to the previously initialized input tensor descriptor.

**dyDesc**

*Input.* Handle to the previously initialized input differential tensor descriptor.

**convDesc**

*Input.* Previously initialized convolution descriptor.

**dwDesc**

*Input.* Handle to a previously initialized filter descriptor.

**requestedAlgoCount**

*Input.* The maximum number of elements to be stored in perfResults.

**returnedAlgoCount**

*Output.* The number of output elements stored in perfResults.

**perfResults**

*Output.* A user-allocated array to store performance metrics sorted ascending by compute time.

The possible error values returned by this function and their meanings are listed below.

**Returns****CUDNN\_STATUS\_SUCCESS**

The query was successful.

**CUDNN\_STATUS\_BAD\_PARAM**

At least one of the following conditions are met:

- ▶ One of the parameters `handle`, `xDesc`, `dyDesc`, `convDesc`, `dwDesc`, `perfResults`, `returnedAlgoCount` is `NULL`.
- ▶ The numbers of feature maps of the input tensor and output tensor differ.
- ▶ The **dataType** of the two tensor descriptors or the filter are different.
- ▶ `requestedAlgoCount` is less than or equal to 0.

## 4.96. `cudaGetConvolutionBackwardFilterAlgorithmMaxCount`

```
cudaStatus_t cudaGetConvolutionBackwardFilterAlgorithmMaxCount(
    cudaHandle_t      handle,
    int               *count)
```

This function returns the maximum number of algorithms which can be returned from `cudaFindConvolutionBackwardFilterAlgorithm()` and `cudaGetConvolutionForwardAlgorithm_v7()`. This is the sum of all algorithms plus the sum of all algorithms with Tensor Core operations supported for the current device.

**Parameters**



**handle**

*Input.* Handle to a previously created cuDNN context.

**count**

*Output.* The resulting maximum count of algorithms.

**Returns****CUDNN\_STATUS\_SUCCESS**

The function was successful.

**CUDNN\_STATUS\_BAD\_PARAM**

The provided handle is not allocated properly.

## 4.97. cudnnGetConvolutionBackwardFilterWorkspaceSize

```

cudnnStatus_t cudnnGetConvolutionBackwardFilterWorkspaceSize(
    cudnnHandle_t      handle,
    const cudnnTensorDescriptor_t  xDesc,
    const cudnnTensorDescriptor_t  dyDesc,
    const cudnnConvolutionDescriptor_t  convDesc,
    const cudnnFilterDescriptor_t  dwDesc,
    cudnnConvolutionBwdFilterAlgo_t  algo,
    size_t              *sizeInBytes)

```

This function returns the amount of GPU memory workspace the user needs to allocate to be able to call **cudnnConvolutionBackwardFilter** with the specified algorithm. The workspace allocated will then be passed to the routine **cudnnConvolutionBackwardFilter**. The specified algorithm can be the result of the call to **cudnnGetConvolutionBackwardFilterAlgorithm** or can be chosen arbitrarily by the user. Note that not every algorithm is available for every configuration of the input tensor and/or every configuration of the convolution descriptor.

**Parameters****handle**

*Input.* Handle to a previously created cuDNN context.

**xDesc**

*Input.* Handle to the previously initialized input tensor descriptor.

**dyDesc**

*Input.* Handle to the previously initialized input differential tensor descriptor.

**convDesc**

*Input.* Previously initialized convolution descriptor.

**dwDesc**

*Input.* Handle to a previously initialized filter descriptor.

**algo**

*Input.* Enumerant that specifies the chosen convolution algorithm.

**sizeInBytes**

*Output.* Amount of GPU memory needed as workspace to be able to execute a forward convolution with the specified **algo**.

The possible error values returned by this function and their meanings are listed below.

**Returns****CUDNN\_STATUS\_SUCCESS**

The query was successful.

**CUDNN\_STATUS\_BAD\_PARAM**

At least one of the following conditions are met:

- ▶ The numbers of feature maps of the input tensor and output tensor differ.
- ▶ The **dataType** of the two tensor descriptors or the filter are different.

**CUDNN\_STATUS\_NOT\_SUPPORTED**

The combination of the tensor descriptors, filter descriptor and convolution descriptor is not supported for the specified algorithm.

## 4.98. cudnnGetConvolutionForwardAlgorithm

```

cudnnStatus_t cudnnGetConvolutionForwardAlgorithm(
    cudnnHandle_t          handle,
    const cudnnTensorDescriptor_t  xDesc,
    const cudnnFilterDescriptor_t  wDesc,
    const cudnnConvolutionDescriptor_t  convDesc,
    const cudnnTensorDescriptor_t  yDesc,
    cudnnConvolutionFwdPreference_t  preference,
    size_t                 memoryLimitInBytes,
    cudnnConvolutionFwdAlgo_t      *algo)

```

This function serves as a heuristic for obtaining the best suited algorithm for **cudnnConvolutionForward** for the given layer specifications. Based on the input preference, this function will either return the fastest algorithm or the fastest algorithm within a given memory limit. For an exhaustive search for the fastest algorithm, please use **cudnnFindConvolutionForwardAlgorithm**.

**Parameters****handle**

*Input.* Handle to a previously created cuDNN context.

**xDesc**

*Input.* Handle to the previously initialized input tensor descriptor.

**wDesc**

*Input.* Handle to a previously initialized convolution filter descriptor.

**convDesc**

*Input.* Previously initialized convolution descriptor.

**yDesc**

*Input.* Handle to the previously initialized output tensor descriptor.

**preference**

*Input.* Enumerant to express the preference criteria in terms of memory requirement and speed.

**memoryLimitInBytes**

*Input.* It is used when enumerant **preference** is set to **CUDNN\_CONVOLUTION\_FWD\_SPECIFY\_WORKSPACE\_LIMIT** to specify the maximum amount of GPU memory the user is willing to use as a workspace

**algo**

*Output.* Enumerant that specifies which convolution algorithm should be used to compute the results according to the specified preference

The possible error values returned by this function and their meanings are listed below.

**Returns****CUDNN\_STATUS\_SUCCESS**

The query was successful.

**CUDNN\_STATUS\_BAD\_PARAM**

At least one of the following conditions are met:

- ▶ One of the parameters handle, xDesc, wDesc, convDesc, yDesc is NULL.
- ▶ Either yDesc or wDesc have different dimensions from xDesc.
- ▶ The data types of tensors xDesc, yDesc or wDesc are not all the same.
- ▶ The number of feature maps in xDesc and wDesc differs.
- ▶ The tensor xDesc has a dimension smaller than 3.

## 4.99. cudnnGetConvolutionForwardAlgorithm\_v7

```

cudnnStatus_t cudnnGetConvolutionForwardAlgorithm_v7(
    cudnnHandle_t          handle,
    const cudnnTensorDescriptor_t  xDesc,
    const cudnnFilterDescriptor_t   wDesc,
    const cudnnConvolutionDescriptor_t convDesc,
    const cudnnTensorDescriptor_t  yDesc,
    const int              requestedAlgoCount,
    int                    *returnedAlgoCount,
    cudnnConvolutionFwdAlgoPerf_t  *perfResults)

```

This function serves as a heuristic for obtaining the best suited algorithm for **cudnnConvolutionForward** for the given layer specifications. This function will return all algorithms (including CUDNN\_TENSOR\_OP\_MATH and CUDNN\_DEFAULT\_MATH versions of algorithms where CUDNN\_TENSOR\_OP\_MATH may be available) sorted by expected (based on internal heuristic) relative performance with fastest being index 0 of perfResults. For an exhaustive search for the fastest algorithm, please use

**cudaDnnFindConvolutionForwardAlgorithm**. The total number of resulting algorithms can be queried through the API **cudaDnnGetConvolutionForwardMaxCount()**.

### Parameters

#### handle

*Input.* Handle to a previously created cuDNN context.

#### xDesc

*Input.* Handle to the previously initialized input tensor descriptor.

#### wDesc

*Input.* Handle to a previously initialized convolution filter descriptor.

#### convDesc

*Input.* Previously initialized convolution descriptor.

#### yDesc

*Input.* Handle to the previously initialized output tensor descriptor.

#### requestedAlgoCount

*Input.* The maximum number of elements to be stored in perfResults.

#### returnedAlgoCount

*Output.* The number of output elements stored in perfResults.

#### perfResults

*Output.* A user-allocated array to store performance metrics sorted ascending by compute time.

The possible error values returned by this function and their meanings are listed below.

### Returns

#### CUDNN\_STATUS\_SUCCESS

The query was successful.

#### CUDNN\_STATUS\_BAD\_PARAM

At least one of the following conditions are met:

- ▶ One of the parameters handle, xDesc, wDesc, convDesc, yDesc, perfResults, returnedAlgoCount is NULL.
- ▶ Either yDesc or wDesc have different dimensions from xDesc.
- ▶ The data types of tensors xDesc, yDesc or wDesc are not all the same.
- ▶ The number of feature maps in xDesc and wDesc differs.
- ▶ The tensor xDesc has a dimension smaller than 3.
- ▶ requestedAlgoCount is less than or equal to 0.

## 4.100. cudaDnnGetConvolutionForwardAlgorithmMaxCount

```
cudaDnnStatus_t cudaDnnGetConvolutionForwardAlgorithmMaxCount(
    cudaDnnHandle_t handle,
```

```
int *count)
```

This function returns the maximum number of algorithms which can be returned from `cuda::cudnnFindConvolutionForwardAlgorithm()` and `cuda::cudnnGetConvolutionForwardAlgorithm_v7()`. This is the sum of all algorithms plus the sum of all algorithms with Tensor Core operations supported for the current device.

### Parameters

#### handle

*Input.* Handle to a previously created cuDNN context.

#### count

*Output.* The resulting maximum number of algorithms.

### Returns

#### CUDNN\_STATUS\_SUCCESS

The function was successful.

#### CUDNN\_STATUS\_BAD\_PARAM

The provided handle is not allocated properly.

## 4.101. cudnnGetConvolutionForwardWorkspaceSize

```
cuda::cudnnStatus_t cuda::cudnnGetConvolutionForwardWorkspaceSize(
    cuda::cudnnHandle_t handle,
    const cuda::cudnnTensorDescriptor_t xDesc,
    const cuda::cudnnFilterDescriptor_t wDesc,
    const cuda::cudnnConvolutionDescriptor_t convDesc,
    const cuda::cudnnTensorDescriptor_t yDesc,
    cuda::cudnnConvolutionFwdAlgo_t algo,
    size_t *sizeInBytes)
```

This function returns the amount of GPU memory workspace the user needs to allocate to be able to call `cuda::cudnnConvolutionForward` with the specified algorithm. The workspace allocated will then be passed to the routine `cuda::cudnnConvolutionForward`. The specified algorithm can be the result of the call to `cuda::cudnnGetConvolutionForwardAlgorithm` or can be chosen arbitrarily by the user. Note that not every algorithm is available for every configuration of the input tensor and/or every configuration of the convolution descriptor.

### Parameters

#### handle

*Input.* Handle to a previously created cuDNN context.

#### xDesc

*Input.* Handle to the previously initialized x tensor descriptor.

#### wDesc

*Input.* Handle to a previously initialized filter descriptor.

**convDesc**

*Input.* Previously initialized convolution descriptor.

**yDesc**

*Input.* Handle to the previously initialized y tensor descriptor.

**algo**

*Input.* Enumerant that specifies the chosen convolution algorithm

**sizeInBytes**

*Output.* Amount of GPU memory needed as workspace to be able to execute a forward convolution with the specified **algo**

The possible error values returned by this function and their meanings are listed below.

**Returns****CUDNN\_STATUS\_SUCCESS**

The query was successful.

**CUDNN\_STATUS\_BAD\_PARAM**

At least one of the following conditions are met:

- ▶ One of the parameters handle, xDesc, wDesc, convDesc, yDesc is NULL.
- ▶ The tensor yDesc or wDesc are not of the same dimension as xDesc.
- ▶ The tensor xDesc, yDesc or wDesc are not of the same data type.
- ▶ The numbers of feature maps of the tensor xDesc and wDesc differ.
- ▶ The tensor xDesc has a dimension smaller than 3.

**CUDNN\_STATUS\_NOT\_SUPPORTED**

The combination of the tensor descriptors, filter descriptor and convolution descriptor is not supported for the specified algorithm.

## 4.102. cudnnGetConvolutionGroupCount

```

cudnnStatus_t cudnnGetConvolutionGroupCount (
    cudnnConvolutionDescriptor_t    convDesc,
    int                             *groupCount)

```

This function returns the group count specified in the given convolution descriptor.

**Returns****CUDNN\_STATUS\_SUCCESS**

The group count was returned successfully.

**CUDNN\_STATUS\_BAD\_PARAM**

An invalid convolution descriptor was provided.

## 4.103. cudnnGetConvolutionMathType

```

cudnnStatus_t cudnnGetConvolutionMathType(
    cudnnConvolutionDescriptor_t   convDesc,
    cudnnMathType_t               *mathType)

```

This function returns the math type specified in a given convolution descriptor.

### Returns

#### **CUDNN\_STATUS\_SUCCESS**

The math type was returned successfully.

#### **CUDNN\_STATUS\_BAD\_PARAM**

An invalid convolution descriptor was provided.

## 4.104. cudnnGetConvolutionNdDescriptor

```

cudnnStatus_t cudnnGetConvolutionNdDescriptor(
    const cudnnConvolutionDescriptor_t convDesc,
    int          arrayLengthRequested,
    int          *arrayLength,
    int          padA[],
    int          filterStrideA[],
    int          dilationA[],
    cudnnConvolutionMode_t *mode,
    cudnnDataType_t *dataType)

```

This function queries a previously initialized convolution descriptor object.

### Parameters

#### **convDesc**

*Input/Output.* Handle to a previously created convolution descriptor.

#### **arrayLengthRequested**

*Input.* Dimension of the expected convolution descriptor. It is also the minimum size of the arrays **padA**, **filterStrideA** and **dilationA** in order to be able to hold the results

#### **arrayLength**

*Output.* Actual dimension of the convolution descriptor.

#### **padA**

*Output.* Array of dimension of at least **arrayLengthRequested** that will be filled with the padding parameters from the provided convolution descriptor.

#### **filterStrideA**

*Output.* Array of dimension of at least **arrayLengthRequested** that will be filled with the filter stride from the provided convolution descriptor.

**dilationA**

*Output.* Array of dimension of at least **arrayLengthRequested** that will be filled with the dilation parameters from the provided convolution descriptor.

**mode**

*Output.* Convolution mode of the provided descriptor.

**datatype**

*Output.* Datatype of the provided descriptor.

**Returns****CUDNN\_STATUS\_SUCCESS**

The query was successfully.

**CUDNN\_STATUS\_BAD\_PARAM**

At least one of the following conditions are met:

- ▶ The descriptor **convDesc** is nil.
- ▶ The **arrayLengthRequest** is negative.

**CUDNN\_STATUS\_NOT\_SUPPORTED**

The **arrayLengthRequested** is greater than CUDNN\_DIM\_MAX-2.

## 4.105. cudnnGetConvolutionNdForwardOutputDim

```

cudnnStatus_t cudnnGetConvolutionNdForwardOutputDim(
    const cudnnConvolutionDescriptor_t  convDesc,
    const cudnnTensorDescriptor_t      inputTensorDesc,
    const cudnnFilterDescriptor_t       filterDesc,
    int                                   nbDims,
    int                                   tensorOutputDimA[])

```

This function returns the dimensions of the resulting n-D tensor of a **nbDims-2-D** convolution, given the convolution descriptor, the input tensor descriptor and the filter descriptor. This function can help to setup the output tensor and allocate the proper amount of memory prior to launch the actual convolution.

Each dimension of the **(nbDims-2) -D** images of the output tensor is computed as followed:

```

outputDim = 1 + ( inputDim + 2*pad - (((filterDim-1)*dilation)+1) ) /
convolutionStride;

```



The dimensions provided by this routine must be strictly respected when calling **cudnnConvolutionForward()** or **cudnnConvolutionBackwardBias()**. Providing a smaller or larger output tensor is not supported by the convolution routines.

**Parameters**



**convDesc**

*Input.* Handle to a previously created convolution descriptor.

**inputTensorDesc**

*Input.* Handle to a previously initialized tensor descriptor.

**filterDesc**

*Input.* Handle to a previously initialized filter descriptor.

**nbDims**

*Input.* Dimension of the output tensor

**tensorOutputDimA**

*Output.* Array of dimensions **nbDims** that contains on exit of this routine the sizes of the output tensor

The possible error values returned by this function and their meanings are listed below.

**Returns****CUDNN\_STATUS\_BAD\_PARAM**

At least one of the following conditions are met:

- ▶ One of the parameters **convDesc**, **inputTensorDesc**, and **filterDesc**, is nil
- ▶ The dimension of the filter descriptor **filterDesc** is different from the dimension of input tensor descriptor **inputTensorDesc**.
- ▶ The dimension of the convolution descriptor is different from the dimension of input tensor descriptor **inputTensorDesc** - 2 .
- ▶ The features map of the filter descriptor **filterDesc** is different from the one of input tensor descriptor **inputTensorDesc**.
- ▶ The size of the dilated filter **filterDesc** is larger than the padded sizes of the input tensor.
- ▶ The dimension **nbDims** of the output array is negative or greater than the dimension of input tensor descriptor **inputTensorDesc**.

**CUDNN\_STATUS\_SUCCESS**

The routine exits successfully.

## 4.106. cudnnGetConvolutionReorderType

```

cudnnStatus_t cudnnGetConvolutionReorderType(
    cudnnConvolutionDescriptor_t convDesc,
    cudnnReorderType_t *reorderType);

```

This function retrieves the convolution reorder type from the given convolution descriptor.

**Parameters:**

Parameter	Input / Output	Description
-----------	----------------	-------------

convDesc	Input	The convolution descriptor from which the reorder type should be retrieved.
reorderType	Output	The retrieved reorder type. See <a href="#">cudnnReorderType_t</a> .

**Returns:**

Return Value	Description
CUDNN_STATUS_BAD_PARAM	One of the inputs to this function is not valid.
CUDNN_STATUS_SUCCESS	The reorder type is retrieved successfully.

## 4.107. cudnnGetCTCLossDescriptor

```

cudnnStatus_t cudnnGetCTCLossDescriptor(
    cudnnCTCLossDescriptor_t      ctcLossDesc,
    cudnnDataType_t*              compType)

```

This function returns configuration of the passed CTC loss function descriptor.

**Parameters****ctcLossDesc**

*Input.* CTC loss function descriptor passed, from which to retrieve the configuration.

**compType**

*Output.* Compute type associated with this CTC loss function descriptor.

**Returns****CUDNN\_STATUS\_SUCCESS**

The function returned successfully.

**CUDNN\_STATUS\_BAD\_PARAM**

Input OpTensor descriptor passed is invalid.

## 4.108. cudnnGetCTCLossWorkspaceSize

```

cudnnStatus_t cudnnGetCTCLossWorkspaceSize(
    cudnnHandle_t      handle,
    const cudnnTensorDescriptor_t      probsDesc,
    const cudnnTensorDescriptor_t      gradientsDesc,
    const int           *labels,
    const int           *labelLengths,
    const int           *inputLengths,
    cudnnCTCLossAlgo_t      algo,
    const cudnnCTCLossDescriptor_t      ctcLossDesc,
    size_t               *sizeInBytes)

```

This function returns the amount of GPU memory workspace the user needs to allocate to be able to call **cudnnCTCLoss** with the specified algorithm. The workspace allocated will then be passed to the routine **cudnnCTCLoss**.

**Parameters**

**handle**

*Input.* Handle to a previously created cuDNN context.

**probsDesc**

*Input.* Handle to the previously initialized probabilities tensor descriptor.

**gradientsDesc**

*Input.* Handle to a previously initialized gradients tensor descriptor.

**labels**

*Input.* Pointer to a previously initialized labels list.

**labelLengths**

*Input.* Pointer to a previously initialized lengths list, to walk the above labels list.

**inputLengths**

*Input.* Pointer to a previously initialized list of the lengths of the timing steps in each batch.

**algo**

*Input.* Enumerant that specifies the chosen CTC loss algorithm

**ctcLossDesc**

*Input.* Handle to the previously initialized CTC loss descriptor.

**sizeInBytes**

*Output.* Amount of GPU memory needed as workspace to be able to execute the CTC loss computation with the specified **algo**.

The possible error values returned by this function and their meanings are listed below.

**Returns****CUDNN\_STATUS\_SUCCESS**

The query was successful.

**CUDNN\_STATUS\_BAD\_PARAM**

At least one of the following conditions are met:

- ▶ The dimensions of probsDesc do not match the dimensions of gradientsDesc.
- ▶ The inputLengths do not agree with the first dimension of probsDesc.
- ▶ The workSpaceSizeInBytes is not sufficient.
- ▶ The labelLengths is greater than 256.

**CUDNN\_STATUS\_NOT\_SUPPORTED**

A compute or data type other than FLOAT was chosen, or an unknown algorithm type was chosen.

## 4.109. cudnnGetCudartVersion

```
size_t cudnnGetCudartVersion()
```

The same version of a given cuDNN library can be compiled against different CUDA Toolkit versions. This routine returns the CUDA Toolkit version that the currently used cuDNN library has been compiled against.

## 4.110. cudnnGetDropoutDescriptor

```

cudnnStatus_t cudnnGetDropoutDescriptor(
    cudnnDropoutDescriptor_t dropoutDesc,
    cudnnHandle_t handle,
    float *dropout,
    void **states,
    unsigned long long *seed)

```

This function queries the fields of a previously initialized dropout descriptor.

### Parameters

#### dropoutDesc

*Input.* Previously initialized dropout descriptor.

#### handle

*Input.* Handle to a previously created cuDNN context.

#### dropout

*Output.* The probability with which the value from input is set to 0 during the dropout layer.

#### states

*Output.* Pointer to user-allocated GPU memory that holds random number generator states.

#### seed

*Output.* Seed used to initialize random number generator states.

The possible error values returned by this function and their meanings are listed below.

### Returns

#### CUDNN\_STATUS\_SUCCESS

The call was successful.

#### CUDNN\_STATUS\_BAD\_PARAM

One or more of the arguments was an invalid pointer.

## 4.111. cudnnGetErrorString

```

const char * cudnnGetErrorString(cudnnStatus_t status)

```

This function converts the cuDNN status code to a NUL terminated (ASCIIZ) static string. For example, when the input argument is CUDNN\_STATUS\_SUCCESS, the returned string is "CUDNN\_STATUS\_SUCCESS". When an invalid status value is passed to the function, the returned string is "CUDNN\_UNKNOWN\_STATUS".

**Parameters****status**

*Input.* cuDNN enumerated status code.

**Returns**

Pointer to a static, NUL terminated string with the status name.

## 4.112. cudnnGetFilter4dDescriptor

```

cudnnStatus_t cudnnGetFilter4dDescriptor(
    const cudnnFilterDescriptor_t filterDesc,
    cudnnDataType_t *dataType,
    cudnnTensorFormat_t *format,
    int *k,
    int *c,
    int *h,
    int *w)

```

This function queries the parameters of the previously initialized filter descriptor object.

**Parameters****filterDesc**

*Input.* Handle to a previously created filter descriptor.

**datatype**

*Output.* Data type.

**format**

*Output.* Type of format.

**k**

*Output.* Number of output feature maps.

**c**

*Output.* Number of input feature maps.

**h**

*Output.* Height of each filter.

**w**

*Output.* Width of each filter.

The possible error values returned by this function and their meanings are listed below.

**Returns****CUDNN\_STATUS\_SUCCESS**

The object was set successfully.

## 4.113. cudnnGetFilterNdDescriptor

```

cudnnStatus_t cudnnGetFilterNdDescriptor(
    const cudnnFilterDescriptor_t  wDesc,
    int                             nbDimsRequested,
    cudnnDataType_t                *dataType,
    cudnnTensorFormat_t           *format,
    int                             *nbDims,
    int                             filterDimA[])

```

This function queries a previously initialized filter descriptor object.

### Parameters

#### wDesc

*Input.* Handle to a previously initialized filter descriptor.

#### nbDimsRequested

*Input.* Dimension of the expected filter descriptor. It is also the minimum size of the arrays **filterDimA** in order to be able to hold the results

#### datatype

*Output.* Data type.

#### format

*Output.* Type of format.

#### nbDims

*Output.* Actual dimension of the filter.

#### filterDimA

*Output.* Array of dimension of at least **nbDimsRequested** that will be filled with the filter parameters from the provided filter descriptor.

The possible error values returned by this function and their meanings are listed below.

### Returns

#### CUDNN\_STATUS\_SUCCESS

The object was set successfully.

#### CUDNN\_STATUS\_BAD\_PARAM

The parameter **nbDimsRequested** is negative.

## 4.114. cudnnGetFusedOpsConstParamPackAttribute

```

cudnnStatus_t cudnnGetFusedOpsConstParamPackAttribute(
    const cudnnFusedOpsConstParamPack_t constPack,
    cudnnFusedOpsConstParamLabel_t paramLabel,
    void *param,
    int *isNULL);

```

This function retrieves the values of the descriptor pointed to by the `param` pointer input. The type of the descriptor is indicated by the enum value of `paramLabel` input.

#### Parameters:

Parameter	Input / Output	Description
<code>constPack</code>	Input	The opaque <code>cudaFusedOpsConstParamPack_t</code> structure that contains the various problem size information, such as the shape, layout and the type of Tensors, and the descriptors for convolution and activation, for the selected sequence of <code>cudaFusedOps</code> computations.
<code>paramLabel</code>	Input	Several types of descriptors can be retrieved by this getter function. The <code>param</code> input points to the descriptor itself, and this input indicates the type of the descriptor pointed to by the <code>param</code> input. The <code>cudaFusedOpsConstParamLabel_t</code> enumerated type enables the selection of the type of the descriptor. See the <code>param</code> description below.
<code>param</code>	Input	Data pointer to the host memory associated with the descriptor that should be retrieved. The type of this descriptor depends on the value of <code>paramLabel</code> . For the given <code>paramLabel</code> , if the associated value inside the <code>constPack</code> is set to NULL or by default NULL, then cuDNN will copy the value or the opaque structure in the <code>constPack</code> to the host memory buffer pointed to by <code>param</code> . See the table in <code>cudaFusedOpsConstParamLabel_t</code> .
<code>isNULL</code>	Input/Output	User must pass a pointer to an integer in the host memory in this field. If the value in the <code>constPack</code> associated with the given <code>paramLabel</code> is by default NULL or previously set by the user to NULL, then cuDNN will write a non-zero value to the location pointed by <code>isNULL</code> .

#### Returns:

Return Value	Description
<code>CUDNN_STATUS_SUCCESS</code>	The descriptor values are retrieved successfully.
<code>CUDNN_STATUS_BAD_PARAM</code>	If either <code>constPack</code> or <code>param</code> or <code>isNULL</code> is NULL; or if <code>paramLabel</code> is invalid.

## 4.115. `cudaGetFusedOpsVariantParamPackAttribute`

```
cudaStatus_t cudaGetFusedOpsVariantParamPackAttribute (
```

```
const cudnnFusedOpsVariantParamPack_t varPack,
cudnnFusedOpsVariantParamLabel_t paramLabel,
void *ptr);
```

This function retrieves the settings of the variable parameter pack descriptor.

#### Parameters:

Parameter	Input / Output	Description
varPack	Input	Pointer to the cudnnFusedOps variant parameter pack ( <code>varPack</code> ) descriptor.
paramLabel	Input	Type of the buffer pointer parameter (in the <code>varPack</code> descriptor). See <a href="#">cudnnFusedOpsConstParamLabel_t</a> . The retrieved descriptor values vary according to this type.
ptr	Output	Pointer to the host or device memory where the retrieved value is written by this function. The data type of the pointer, and the host/device memory location, depend on the <code>paramLabel</code> input selection. See <a href="#">cudnnFusedOpsVariantParamLabel_t</a> .

#### Returns:

Return Value	Description
CUDNN_STATUS_SUCCESS	The descriptor values are retrieved successfully.
CUDNN_STATUS_BAD_PARAM	If either <code>varPack</code> or <code>ptr</code> is NULL, or if <code>paramLabel</code> is set to invalid value.

## 4.116. cudnnGetLRNDescriptor

```
cudnnStatus_t cudnnGetLRNDescriptor(
    cudnnLRNDescriptor_t normDesc,
    unsigned int *lrnN,
    double *lrnAlpha,
    double *lrnBeta,
    double *lrnK)
```

This function retrieves values stored in the previously initialized LRN descriptor object.

#### Parameters

##### normDesc

*Output.* Handle to a previously created LRN descriptor.

##### lrnN, lrnAlpha, lrnBeta, lrnK

*Output.* Pointers to receive values of parameters stored in the descriptor object. See [cudnnSetLRNDescriptor](#) for more details. Any of these pointers can be NULL (no value is returned for the corresponding parameter).

Possible error values returned by this function and their meanings are listed below.

#### Returns



**CUDNN\_STATUS\_SUCCESS**

Function completed successfully.

## 4.117. cudnnGetMultiHeadAttnBuffers

```

cudnnStatus_t cudnnGetMultiHeadAttnBuffers(
    cudnnHandle_t handle,
    const cudnnAttnDescriptor_t attnDesc,
    size_t *weightSizeInBytes,
    size_t *workSpaceSizeInBytes,
    size_t *reserveSpaceSizeInBytes);

```

This function obtains workspace and reserve space sizes for the multihead attention. When only the workspace size is requested with NULL value for **reserveSpaceSizeInBytes**, it is assumed that the user intention is to invoke **cudnnMultiHeadAttnForward** in the "inference" mode.

### Parameters:

Parameter	Input / Output	Description
handle	Input	cuDNN handle.
attnDesc	Input	Pointer to a previously initialized multi-head attention descriptor.
weightSizeInBytes	Output	Size required to store various projection weights.
workSpaceSizeInBytes	Output	Size required for workspace.
reserveSpaceSizeInBytes	Output	Size required for the reserve space in training mode.

### Returns:

Return Value	Description
CUDNN_STATUS_SUCCESS	The requested spaces values are evaluated successfully.
CUDNN_STATUS_BAD_PARAM	Either invalid values in <b>attnDesc</b> or <b>workSpaceSizeInBytes</b> is NULL.

## 4.118. cudnnGetMultiHeadAttnWeights

```

cudnnStatus_t cudnnGetMultiHeadAttnWeights(
    cudnnHandle_t handle,
    const cudnnAttnDescriptor_t attnDesc,
    cudnnMultiHeadAttnWeightKind_t wKind,
    size_t weightSizeInBytes,
    const void *w,
    cudnnTensorDescriptor_t wDesc,
    void **wAddr);

```

This function obtains the tensor descriptors and pointers to project weight of a particular kind in the weight buffer `w` of size `weightSizeInBytes`. There are four kinds of weights, enumerated in the type `cudaMultiHeadAttnWeightKind_t`.

#### Parameters:

Parameter	Input / Output	Description
<code>handle</code>	Input	A cuDNN context handle.
<code>attnDesc</code>	Input	A previously initialized multi-head attention descriptor.
<code>wKind</code>	Input	The specific weight group (Q, K, V, or O) whose attention weights should be retrieved.
<code>weightSizeInBytes</code>	Input	Pointer to a location, in host memory, where the attention weight sizes (in bytes) are stored.
<code>w</code>	Input	Pointer to weight buffer in device memory.
<code>wDesc</code>	Output	Tensor descriptor for the attention weights. <ul style="list-style-type: none"> <li>- <code>wDesc.dimA</code> are all [nHeads, projected size, input size]</li> <li>- <code>wDesc.strideA</code> describe how the buffer is packed, depending on the projection weight kind.</li> </ul>
<code>wAddr</code>	Output	Pointer to a location, in device memory, of the requested weight tensor. Weight tensor is three dimensional whose dimensions and layout are also returned in tensor descriptor <code>wDesc</code> .  If any of queries, keys, values, or output projection size is zero in the attention descriptor, then <code>wAddr</code> is set to NULL. Check for this before applying the weights.

#### Returns:

Return Value	Description
<code>CUDNN_STATUS_SUCCESS</code>	When weight tensor descriptor and address in the device memory are successfully determined.
<code>CUDNN_STATUS_BAD_PARAM</code>	Invalid or inconsistent value is found. For example when <code>wKind</code> does not have a valid value or when <code>weightSizeInBytes</code> is not equal to the weight buffer size as computed by <code>cudaGetMultiHeadAttnBuffers</code> .

## 4.119. cudnnGetOpTensorDescriptor

```

cudnnStatus_t cudnnGetOpTensorDescriptor(
    const cudnnOpTensorDescriptor_t opTensorDesc,
    cudnnOpTensorOp_t                *opTensorOp,
    cudnnDataType_t                  *opTensorCompType,
    cudnnNanPropagation_t            *opTensorNanOpt)

```

This function returns configuration of the passed Tensor Pointwise math descriptor.

### Parameters

#### opTensorDesc

*Input.* Tensor Pointwise math descriptor passed, to get the configuration from.

#### opTensorOp

*Output.* Pointer to the Tensor Pointwise math operation type, associated with this Tensor Pointwise math descriptor.

#### opTensorCompType

*Output.* Pointer to the cuDNN data-type associated with this Tensor Pointwise math descriptor.

#### opTensorNanOpt

*Output.* Pointer to the NAN propagation option associated with this Tensor Pointwise math descriptor.

### Returns

#### CUDNN\_STATUS\_SUCCESS

The function returned successfully.

#### CUDNN\_STATUS\_BAD\_PARAM

Input Tensor Pointwise math descriptor passed is invalid.

## 4.120. cudnnGetPooling2dDescriptor

```

cudnnStatus_t cudnnGetPooling2dDescriptor(
    const cudnnPoolingDescriptor_t poolingDesc,
    cudnnPoolingMode_t             *mode,
    cudnnNanPropagation_t          *maxpoolingNanOpt,
    int                             *windowHeight,
    int                             *windowWidth,
    int                             *verticalPadding,
    int                             *horizontalPadding,
    int                             *verticalStride,
    int                             *horizontalStride)

```

This function queries a previously created 2D pooling descriptor object.

### Parameters

#### poolingDesc

*Input.* Handle to a previously created pooling descriptor.

**mode**

*Output.* Enumerant to specify the pooling mode.

**maxpoolingNanOpt**

*Output.* Enumerant to specify the Nan propagation mode.

**windowHeight**

*Output.* Height of the pooling window.

**windowWidth**

*Output.* Width of the pooling window.

**verticalPadding**

*Output.* Size of vertical padding.

**horizontalPadding**

*Output.* Size of horizontal padding.

**verticalStride**

*Output.* Pooling vertical stride.

**horizontalStride**

*Output.* Pooling horizontal stride.

The possible error values returned by this function and their meanings are listed below.

**Returns****CUDNN\_STATUS\_SUCCESS**

The object was set successfully.

## 4.121. cudnnGetPooling2dForwardOutputDim

```

cudnnStatus_t cudnnGetPooling2dForwardOutputDim(
    const cudnnPoolingDescriptor_t    poolingDesc,
    const cudnnTensorDescriptor_t    inputDesc,
    int                                *outN,
    int                                *outC,
    int                                *outH,
    int                                *outW)

```

This function provides the output dimensions of a tensor after 2d pooling has been applied

Each dimension **h** and **w** of the output images is computed as followed:

```
outputDim = 1 + (inputDim + 2*padding - windowDim)/poolingStride;
```

**Parameters****poolingDesc**

*Input.* Handle to a previously initialized pooling descriptor.

**inputDesc**

*Input.* Handle to the previously initialized input tensor descriptor.

**N**

*Output.* Number of images in the output.

**C**

*Output.* Number of channels in the output.

**H**

*Output.* Height of images in the output.

**W**

*Output.* Width of images in the output.

The possible error values returned by this function and their meanings are listed below.

**Returns****CUDNN\_STATUS\_SUCCESS**

The function launched successfully.

**CUDNN\_STATUS\_BAD\_PARAM**

At least one of the following conditions are met:

- ▶ **poolingDesc** has not been initialized.
- ▶ **poolingDesc** or **inputDesc** has an invalid number of dimensions (2 and 4 respectively are required).

## 4.122. cudnnGetPoolingNdDescriptor

```

cudnnStatus_t cudnnGetPoolingNdDescriptor(
const cudnnPoolingDescriptor_t poolingDesc,
int nbDimsRequested,
cudnnPoolingMode_t *mode,
cudnnNanPropagation_t *maxpoolingNanOpt,
int *nbDims,
int windowDimA[],
int paddingA[],
int strideA[])

```

This function queries a previously initialized generic pooling descriptor object.

**Parameters****poolingDesc**

*Input.* Handle to a previously created pooling descriptor.

**nbDimsRequested**

*Input.* Dimension of the expected pooling descriptor. It is also the minimum size of the arrays **windowDimA**, **paddingA** and **strideA** in order to be able to hold the results.

**mode**

*Output.* Enumerant to specify the pooling mode.

**maxpoolingNanOpt**

*Input.* Enumerant to specify the Nan propagation mode.

**nbDims**

*Output.* Actual dimension of the pooling descriptor.

**windowDimA**

*Output.* Array of dimension of at least **nbDimsRequested** that will be filled with the window parameters from the provided pooling descriptor.

**paddingA**

*Output.* Array of dimension of at least **nbDimsRequested** that will be filled with the padding parameters from the provided pooling descriptor.

**strideA**

*Output.* Array of dimension at least **nbDimsRequested** that will be filled with the stride parameters from the provided pooling descriptor.

The possible error values returned by this function and their meanings are listed below.

**Returns****CUDNN\_STATUS\_SUCCESS**

The object was queried successfully.

**CUDNN\_STATUS\_NOT\_SUPPORTED**

The parameter **nbDimsRequested** is greater than CUDNN\_DIM\_MAX.

## 4.123. cudnnGetPoolingNdForwardOutputDim

```

cudnnStatus_t cudnnGetPoolingNdForwardOutputDim(
    const cudnnPoolingDescriptor_t poolingDesc,
    const cudnnTensorDescriptor_t inputDesc,
    int nbDims,
    int outDimA[])

```

This function provides the output dimensions of a tensor after Nd pooling has been applied

Each dimension of the **(nbDims-2) -D** images of the output tensor is computed as followed:

```
outputDim = 1 + (inputDim + 2*padding - windowDim)/poolingStride;
```

**Parameters****poolingDesc**

*Input.* Handle to a previously initialized pooling descriptor.

**inputDesc**

*Input.* Handle to the previously initialized input tensor descriptor.

**nbDims**

*Input.* Number of dimensions in which pooling is to be applied.

**outDimA**

*Output.* Array of nbDims output dimensions.

The possible error values returned by this function and their meanings are listed below.

**Returns****CUDNN\_STATUS\_SUCCESS**

The function launched successfully.

**CUDNN\_STATUS\_BAD\_PARAM**

At least one of the following conditions are met:

- ▶ **poolingDesc** has not been initialized.
- ▶ The value of **nbDims** is inconsistent with the dimensionality of **poolingDesc** and **inputDesc**.

## 4.124. cudnnGetProperty

```

cudnnStatus_t cudnnGetProperty(
    libraryPropertyType  type,
    int                  *value)

```

This function writes a specific part of the cuDNN library version number into the provided host storage.

**Parameters****type**

*Input.* Enumerated type that instructs the function to report the numerical value of the cuDNN major version, minor version, or the patch level.

**value**

*Output.* Host pointer where the version information should be written.

**Returns****CUDNN\_STATUS\_INVALID\_VALUE**

Invalid value of the **type** argument.

**CUDNN\_STATUS\_SUCCESS**

Version information was stored successfully at the provided address.

## 4.125. cudnnGetReduceTensorDescriptor

```

cudnnStatus_t cudnnGetReduceTensorDescriptor(

```

```

const cudnnReduceTensorDescriptor_t reduceTensorDesc,
cudnnReduceTensorOp_t *reduceTensorOp,
cudnnDataType_t *reduceTensorCompType,
cudnnNanPropagation_t *reduceTensorNanOpt,
cudnnReduceTensorIndices_t *reduceTensorIndices,
cudnnIndicesType_t *reduceTensorIndicesType)

```

This function queries a previously initialized reduce tensor descriptor object.

### Parameters

#### reduceTensorDesc

*Input.* Pointer to a previously initialized reduce tensor descriptor object.

#### reduceTensorOp

*Output.* Enumerant to specify the reduce tensor operation.

#### reduceTensorCompType

*Output.* Enumerant to specify the computation datatype of the reduction.

#### reduceTensorNanOpt

*Input.* Enumerant to specify the Nan propagation mode.

#### reduceTensorIndices

*Output.* Enumerant to specify the reduce tensor indices.

#### reduceTensorIndicesType

*Output.* Enumerant to specify the reduce tensor indices type.

### Returns

#### CUDNN\_STATUS\_SUCCESS

The object was queried successfully.

#### CUDNN\_STATUS\_BAD\_PARAM

reduceTensorDesc is NULL.

## 4.126. cudnnGetReductionIndicesSize

```

cudnnStatus_t cudnnGetReductionIndicesSize(
    cudnnHandle_t handle,
    const cudnnReduceTensorDescriptor_t reduceDesc,
    const cudnnTensorDescriptor_t aDesc,
    const cudnnTensorDescriptor_t cDesc,
    size_t *sizeInBytes)

```

This is a helper function to return the minimum size of the index space to be passed to the reduction given the input and output tensors.

### Parameters

#### handle

*Input.* Handle to a previously created cuDNN library descriptor.

#### reduceDesc

*Input.* Pointer to a previously initialized reduce tensor descriptor object.



**aDesc**

*Input.* Pointer to the input tensor descriptor.

**cDesc**

*Input.* Pointer to the output tensor descriptor.

**sizeInBytes**

*Output.* Minimum size of the index space to be passed to the reduction.

**Returns****CUDNN\_STATUS\_SUCCESS**

The index space size is returned successfully.

## 4.127. cudnnGetReductionWorkspaceSize

```

cudnnStatus_t cudnnGetReductionWorkspaceSize(
    cudnnHandle_t      handle,
    const cudnnReduceTensorDescriptor_t reduceDesc,
    const cudnnTensorDescriptor_t      aDesc,
    const cudnnTensorDescriptor_t      cDesc,
    size_t              *sizeInBytes)

```

This is a helper function to return the minimum size of the workspace to be passed to the reduction given the input and output tensors.

**Parameters****handle**

*Input.* Handle to a previously created cuDNN library descriptor.

**reduceDesc**

*Input.* Pointer to a previously initialized reduce tensor descriptor object.

**aDesc**

*Input.* Pointer to the input tensor descriptor.

**cDesc**

*Input.* Pointer to the output tensor descriptor.

**sizeInBytes**

*Output.* Minimum size of the index space to be passed to the reduction.

**Returns****CUDNN\_STATUS\_SUCCESS**

The workspace size is returned successfully.

## 4.128. cudnnGetRNNBiasMode

```

cudnnStatus_t cudnnGetRNNBiasMode(
    cudnnRNNDescriptor_t rnnDesc,

```

```

    cudnnRNNBiasMode_t      *biasMode)

```

This function retrieves the RNN bias mode that was configured by `cudaSetRNNBiasMode()`. The default value of `biasMode` in `rnnDesc` after `cudaCreateRNNDescriptor()` is `CUDNN_RNN_DOUBLE_BIAS`.

### Parameters

#### `rnnDesc`

*Input.* A previously created RNN descriptor.

#### `*biasMode`

*Input.* Pointer where RNN bias mode should be saved.

### Returns

#### `CUDNN_STATUS_BAD_PARAM`

Either the `rnnDesc` or `*biasMode` is NULL.

#### `CUDNN_STATUS_SUCCESS`

The `biasMode` parameter was retrieved set successfully.

## 4.129. `cudaGetRNNDataDescriptor`

```

cudaStatus_t cudaGetRNNDataDescriptor(
    cudaRNNDataDescriptor_t      RNNDataDesc,
    cudaDataType_t               *dataType,
    cudaRNNDataLayout_t         *layout,
    int                          *maxSeqLength,
    int                          *batchSize,
    int                          *vectorSize,
    int                          arrayLengthRequested,
    int                          seqLengthArray[],
    void                         *paddingFill);

```

This function retrieves a previously created RNN data descriptor object.

### Parameters

#### `RNNDataDesc`

*Input.* A previously created and initialized RNN descriptor.

#### `dataType`

*Output.* Pointer to the host memory location to store the datatype of the RNN data tensor.

#### `layout`

*Output.* Pointer to the host memory location to store the memory layout of the RNN data tensor.

#### `maxSeqLength`

*Output.* The maximum sequence length within this RNN data tensor, including the padding vectors.

**batchSize**

*Output.* The number of sequences within the mini-batch.

**vectorSize**

*Output.* The vector length (i.e. embedding size) of the input or output tensor at each timestep.

**arrayLengthRequested**

*Input.* The number of elements that the user requested for **seqLengthArray**.

**seqLengthArray**

*Output.* Pointer to the host memory location to store the integer array describing the length (i.e. number of timesteps) of each sequence. This is allowed to be a NULL pointer if **arrayLengthRequested** is zero.

**paddingFill**

*Output.* Pointer to the host memory location to store the user defined symbol. The symbol should be interpreted as the same data type as the RNN data tensor.

**Returns****CUDNN\_STATUS\_SUCCESS**

The parameters are fetched successfully.

**CUDNN\_STATUS\_BAD\_PARAM**

Any one of these have occurred:

- ▶ Any of **RNNDataDesc**, **dataType**, **layout**, **maxSeqLength**, **batchSize**, **vectorSize**, **paddingFill** is NULL.
- ▶ **seqLengthArray** is NULL while **arrayLengthRequested** is greater than zero.
- ▶ **arrayLengthRequested** is less than zero.

## 4.130. cudnnGetRNNDescriptor

```

cudnnStatus_t cudnnGetRNNDescriptor(
    cudnnHandle_t          handle,
    cudnnRNNDescriptor_t  rnnDesc,
    int *                  hiddenSize,
    int *                  numLayers,
    cudnnDropoutDescriptor_t * dropoutDesc,
    cudnnRNNInputMode_t * inputMode,
    cudnnDirectionMode_t * direction,
    cudnnRNNMode_t *      mode,
    cudnnRNNAlgo_t *      algo,
    cudnnDataType_t *     dataType)

```

This function retrieves RNN network parameters that were configured by `cudnnSetRNNDescriptor()`. All pointers passed to the function should be not-NULL or `CUDNN_STATUS_BAD_PARAM` is reported. The function does not check the validity of retrieved network parameters. The parameters are verified when they are written to the RNN descriptor.

**Parameters**

**handle**

*Input.* Handle to a previously created cuDNN library descriptor.

**rnnDesc**

*Input.* A previously created and initialized RNN descriptor.

**hiddenSize**

*Output.* Pointer where the size of the hidden state should be stored (the same value is used in every layer).

**numLayers**

*Output.* Pointer where the number of RNN layers should be stored.

**dropoutDesc**

*Output.* Pointer where the handle to a previously configured dropout descriptor should be stored.

**inputMode**

*Output.* Pointer where the mode of the first RNN layer should be saved.

**direction**

*Output.* Pointer where RNN uni-directional/bi-directional mode should be saved.

**mode**

*Output.* Pointer where RNN cell type should be saved.

**algo**

*Output.* Pointer where RNN algorithm type should be stored.

**dataType**

*Output.* Pointer where the data type of RNN weights/biases should be stored.

**Returns****CUDNN\_STATUS\_SUCCESS**

RNN parameters were successfully retrieved from the RNN descriptor.

**CUDNN\_STATUS\_BAD\_PARAM**

At least one pointer passed to the `cudaGetRNNDescriptor()` function is NULL.

## 4.131. `cudaGetRNNLinLayerBiasParams`

```

cudaStatus_t cudaGetRNNLinLayerBiasParams (
    cudaHandle_t          handle,
    const cudaRNNDescriptor_t  rnnDesc,
    const int             pseudoLayer,
    const cudaTensorDescriptor_t  xDesc,
    const cudaFilterDescriptor_t  wDesc,
    const void            *w,
    const int             linLayerID,
    cudaFilterDescriptor_t  linLayerBiasDesc,
    void                  **linLayerBias)

```

This function is used to obtain a pointer and a descriptor of every RNN bias column vector in each pseudo-layer within the recurrent network defined by `rnnDesc` and its input width specified in `xDesc`.

 The `cudaGetRNNLinLayerBiasParams()` function was changed in cuDNN version 7.1.1 to match the behavior of `cudaGetRNNLinLayerMatrixParams()`.

The `cudaGetRNNLinLayerBiasParams()` function returns the RNN bias vector size in two dimensions: rows and columns.

Due to historical reasons, the minimum number of dimensions in the filter descriptor is three. In previous versions of the cuDNN library, the function returned the total number of vector elements in `linLayerBiasDesc` as follows:

```
filterDimA[0]=total_size,
filterDimA[1]=1,
filterDimA[2]=1
```

(see the description of the `cudaGetFilterNdDescriptor()` function).

In v7.1.1, the format was changed to:

```
filterDimA[0]=1,
filterDimA[1]=rows,
filterDimA[2]=1 (number of columns).
```

In both cases, the "format" field of the filter descriptor should be ignored when retrieved by `cudaGetFilterNdDescriptor()`.

Note that the RNN implementation in cuDNN uses two bias vectors before the cell non-linear function (see equations in Chapter 3 describing the `cudaRNNMode_t` enumerated type).

Note that the RNN implementation in cuDNN depends on the number of bias vectors before the cell non-linear function. See the equations in the `cudaRNNMode_t` description, for the enumerated type based on the value of `cudaRNNBiasMode_t biasMode` in `rnnDesc`. If nonexistent biases are referenced by `linLayerID`, then this function sets `linLayerBiasDesc` to a zeroed filter descriptor where:

```
filterDimA[0]=0,
filterDimA[1]=0, and
filterDimA[2]=2
```

and sets `linLayerBias` to NULL. See the details for function parameter `linLayerID` to determine the relevant values of `linLayerID` based on `biasMode`.

## Parameters

### `handle`

*Input.* Handle to a previously created cuDNN library descriptor.

### `rnnDesc`

*Input.* A previously initialized RNN descriptor.

### `pseudoLayer`

*Input.* The pseudo-layer to query. In uni-directional RNN-s, a pseudo-layer is the same as a "physical" layer (`pseudoLayer=0` is the RNN input layer, `pseudoLayer=1` is

the first hidden layer). In bi-directional RNN-s there are twice as many pseudo-layers in comparison to "physical" layers (pseudoLayer=0 and pseudoLayer=1 are both input layers; pseudoLayer=0 refers to the forward part and pseudoLayer=1 refers to the backward part of the "physical" input layer; pseudoLayer=2 is the forward part of the first hidden layer, and so on).

#### **xDesc**

*Input.* A fully packed tensor descriptor describing the input to one recurrent iteration (to retrieve the RNN input width).

#### **wDesc**

*Input.* Handle to a previously initialized filter descriptor describing the weights for the RNN.

#### **w**

*Input.* Data pointer to GPU memory associated with the filter descriptor **wDesc**.

#### **linLayerID**

*Input.* The linear layer to obtain information about:

- ▶ ▶ If mode in **rnnDesc** was set to **CUDNN\_RNN\_RELU** or **CUDNN\_RNN\_TANH**:
  - ▶ Value 0 references the bias applied to the input from the previous layer (relevant if **biasMode** in **rnnDesc** is **CUDNN\_RNN\_SINGLE\_INP\_BIAS** or **CUDNN\_RNN\_DOUBLE\_BIAS**).
  - ▶ Value 1 references the bias applied to the recurrent input (relevant if **biasMode** in **rnnDesc** is **CUDNN\_RNN\_DOUBLE\_BIAS** or **CUDNN\_RNN\_SINGLE\_REC\_BIAS**).
- ▶ If mode in **rnnDesc** was set to **CUDNN\_LSTM**,
  - ▶ Values of 0, 1, 2 and 3 reference bias applied to the input from the previous layer (relevant if **biasMode** in **rnnDesc** is **CUDNN\_RNN\_SINGLE\_INP\_BIAS** or **CUDNN\_RNN\_DOUBLE\_BIAS**).
  - ▶ Values of 4, 5, 6 and 7 reference bias applied to the recurrent input (relevant if **biasMode** in **rnnDesc** is **CUDNN\_RNN\_DOUBLE\_BIAS** or **CUDNN\_RNN\_SINGLE\_REC\_BIAS**).
  - ▶ Values and their associated gates:
    - ▶ Values 0 and 4 reference the input gate.
    - ▶ Values 1 and 5 reference the forget gate.
    - ▶ Values 2 and 6 reference the new memory gate.
    - ▶ Values 3 and 7 reference the output gate.
- ▶ If mode in **rnnDesc** was set to **CUDNN\_GRU**,
  - ▶ Values of 0, 1 and 2 reference bias applied to the input from the previous layer (relevant if **biasMode** in **rnnDesc** is **CUDNN\_RNN\_SINGLE\_INP\_BIAS** or **CUDNN\_RNN\_DOUBLE\_BIAS**).
  - ▶ Values of 3, 4 and 5 reference bias applied to the recurrent input (relevant if **biasMode** in **rnnDesc** is **CUDNN\_RNN\_DOUBLE\_BIAS** or **CUDNN\_RNN\_SINGLE\_REC\_BIAS**).
  - ▶ Values and their associated gates:

- ▶ Values 0 and 3 reference the reset gate.
- ▶ Values 1 and 4 reference the update gate.
- ▶ Values 2 and 5 reference the new memory gate.

Also refer to `cudaRNNMode_t` for additional details on modes and bias modes.

### **linLayerBiasDesc**

*Output.* Handle to a previously created filter descriptor.

### **linLayerBias**

*Output.* Data pointer to GPU memory associated with the filter descriptor

**linLayerBiasDesc.**

The possible error values returned by this function and their meanings are listed below.

### **Returns**

#### **CUDNN\_STATUS\_SUCCESS**

The query was successful.

#### **CUDNN\_STATUS\_NOT\_SUPPORTED**

The function does not support the provided configuration.

#### **CUDNN\_STATUS\_BAD\_PARAM**

At least one of the following conditions are met:

- ▶ One of the following arguments is NULL: **handle**, **rnnDesc**, **xDesc**, **wDesc**, **linLayerBiasDesc**, **linLayerBias**.
- ▶ A data type mismatch was detected between **rnnDesc** and other descriptors.
- ▶ Minimum requirement for the 'w' pointer alignment is not satisfied.
- ▶ The value of **pseudoLayer** or **linLayerID** is out of range.

#### **CUDNN\_STATUS\_INVALID\_VALUE**

Some elements of the **linLayerBias** vector are be outside the 'w' buffer boundaries as specified by the **wDesc** descriptor.

## 4.132. cudnnGetRNNLinLayerMatrixParams

```

cudaStatus_t cudnnGetRNNLinLayerMatrixParams (
  cudaHandle_t          handle,
  const cudaRNNDescriptor_t  rnnDesc,
  const int             pseudoLayer,
  const cudaTensorDescriptor_t  xDesc,
  const cudaFilterDescriptor_t  wDesc,
  const void            *w,
  const int             linLayerID,
  cudaFilterDescriptor_t  linLayerMatDesc,
  void                  **linLayerMat)

```

This function is used to obtain a pointer and a descriptor of every RNN weight matrix in each pseudo-layer within the recurrent network defined by **rnnDesc** and its input width specified in **xDesc**.



The `cudaGetRNNLinLayerMatrixParams()` function was enhanced in cuDNN version 7.1.1 without changing its prototype. Instead of reporting the total number of elements in each weight matrix in the "linLayerMatDesc" filter descriptor, the function returns the matrix size as two dimensions: rows and columns. Moreover, when a weight matrix does not exist, e.g due to CUDNN\_SKIP\_INPUT mode, the function returns NULL in `linLayerMat` and all fields of `linLayerMatDesc` are zero.

The `cudaGetRNNLinLayerMatrixParams()` function returns the RNN matrix size in two dimensions: rows and columns. This allows the user to easily print and initialize RNN weight matrices. Elements in each weight matrix are arranged in the row-major order. Due to historical reasons, the minimum number of dimensions in the filter descriptor is three. In previous versions of the cuDNN library, the function returned the total number of weights in `linLayerMatDesc` as follows: `filterDimA[0]=total_size`, `filterDimA[1]=1`, `filterDimA[2]=1` (see the description of the `cudaGetFilterNdDescriptor()` function). In v7.1.1, the format was changed to: `filterDimA[0]=1`, `filterDimA[1]=rows`, `filterDimA[2]=columns`. In both cases, the "format" field of the filter descriptor should be ignored when retrieved by `cudaGetFilterNdDescriptor()`.

### Parameters

#### **handle**

*Input.* Handle to a previously created cuDNN library descriptor.

#### **rnnDesc**

*Input.* A previously initialized RNN descriptor.

#### **pseudoLayer**

*Input.* The pseudo-layer to query. In uni-directional RNN-s, a pseudo-layer is the same as a "physical" layer (`pseudoLayer=0` is the RNN input layer, `pseudoLayer=1` is the first hidden layer). In bi-directional RNN-s there are twice as many pseudo-layers in comparison to "physical" layers (`pseudoLayer=0` and `pseudoLayer=1` are both input layers; `pseudoLayer=0` refers to the forward part and `pseudoLayer=1` refers to the backward part of the "physical" input layer; `pseudoLayer=2` is the forward part of the first hidden layer, and so on).

#### **xDesc**

*Input.* A fully packed tensor descriptor describing the input to one recurrent iteration (to retrieve the RNN input width).

#### **wDesc**

*Input.* Handle to a previously initialized filter descriptor describing the weights for the RNN.

#### **w**

*Input.* Data pointer to GPU memory associated with the filter descriptor **wDesc**.



## linLayerID

*Input.* The linear layer to obtain information about:

- ▶ If **mode** in **rnnDesc** was set to **CUDNN\_RNN\_RELU** or **CUDNN\_RNN\_TANH** a value of 0 references the matrix multiplication applied to the input from the previous layer, a value of 1 references the matrix multiplication applied to the recurrent input.
- ▶ If **mode** in **rnnDesc** was set to **CUDNN\_LSTM** values of 0-3 reference matrix multiplications applied to the input from the previous layer, value of 4-7 reference matrix multiplications applied to the recurrent input.
  - ▶ Values 0 and 4 reference the input gate.
  - ▶ Values 1 and 5 reference the forget gate.
  - ▶ Values 2 and 6 reference the new memory gate.
  - ▶ Values 3 and 7 reference the output gate.
  - ▶ Value 8 references the "recurrent" projection matrix when enabled by the `cudaSetRNNProjectionLayers()` function.
- ▶ If **mode** in **rnnDesc** was set to **CUDNN\_GRU** values of 0-2 reference matrix multiplications applied to the input from the previous layer, value of 3-5 reference matrix multiplications applied to the recurrent input.
  - ▶ Values 0 and 3 reference the reset gate.
  - ▶ Values 1 and 4 reference the update gate.
  - ▶ Values 2 and 5 reference the new memory gate.

Please refer to [Chapter 3](#) for additional details on modes.

## linLayerMatDesc

*Output.* Handle to a previously created filter descriptor. When the weight matrix does not exist, the returned filter descriptor has all fields set to zero.

## linLayerMat

*Output.* Data pointer to GPU memory associated with the filter descriptor **linLayerMatDesc**. When the weight matrix does not exist, the returned pointer is NULL.

The possible error values returned by this function and their meanings are listed below.

### Returns

#### **CUDNN\_STATUS\_SUCCESS**

The query was successful.

#### **CUDNN\_STATUS\_NOT\_SUPPORTED**

The function does not support the provided configuration.

#### **CUDNN\_STATUS\_BAD\_PARAM**

At least one of the following conditions are met:

- ▶ One of the following arguments is NULL: **handle**, **rnnDesc**, **xDesc**, **wDesc**, **linLayerMatDesc**, **linLayerMat**.
- ▶ A data type mismatch was detected between **rnnDesc** and other descriptors.
- ▶ Minimum requirement for the '**w**' pointer alignment is not satisfied.

- ▶ The value of `pseudoLayer` or `linLayerID` is out of range.

#### CUDNN\_STATUS\_INVALID\_VALUE

Some elements of the `linLayerMat` vector are outside the 'w' buffer boundaries as specified by the `wDesc` descriptor.

## 4.133. cudnnGetRNNPaddingMode

```

cudnnStatus_t cudnnGetRNNPaddingMode(
    cudnnRNNDescriptor_t      rnnDesc,
    cudnnRNNPaddingMode_t    *paddingMode)

```

This function retrieves the RNN padding mode from the RNN descriptor.

### Parameters

#### rnnDesc

*Input/Output.* A previously created RNN descriptor.

#### \*paddingMode

*Input.* Pointer to the host memory where the RNN padding mode is saved.

### Returns

#### CUDNN\_STATUS\_SUCCESS

The RNN padding mode parameter was retrieved successfully.

#### CUDNN\_STATUS\_BAD\_PARAM

Either the `rnnDesc` or `*paddingMode` is NULL.

## 4.134. cudnnGetRNNParamsSize

```

cudnnStatus_t cudnnGetRNNParamsSize(
    cudnnHandle_t             handle,
    const cudnnRNNDescriptor_t rnnDesc,
    const cudnnTensorDescriptor_t xDesc,
    size_t                    *sizeInBytes,
    cudnnDataType_t          dataType)

```

This function is used to query the amount of parameter space required to execute the RNN described by `rnnDesc` with inputs dimensions defined by `xDesc`.

### Parameters

#### handle

*Input.* Handle to a previously created cuDNN library descriptor.

#### rnnDesc

*Input.* A previously initialized RNN descriptor.

#### xDesc

*Input.* A fully packed tensor descriptor describing the input to one recurrent iteration.

**sizeInBytes**

*Output.* Minimum amount of GPU memory needed as parameter space to be able to execute an RNN with the specified descriptor and input tensors.

**dataType**

*Input.* The data type of the parameters.

The possible error values returned by this function and their meanings are listed below.

**Returns****CUDNN\_STATUS\_SUCCESS**

The query was successful.

**CUDNN\_STATUS\_BAD\_PARAM**

At least one of the following conditions are met:

- ▶ The descriptor **rnnDesc** is invalid.
- ▶ The descriptor **xDesc** is invalid.
- ▶ The descriptor **xDesc** is not fully packed.
- ▶ The combination of **dataType** and tensor descriptor data type is invalid.

**CUDNN\_STATUS\_NOT\_SUPPORTED**

The combination of the RNN descriptor and tensor descriptors is not supported.

## 4.135. cudnnGetRNNProjectionLayers

```

cudnnStatus_t cudnnGetRNNProjectionLayers(
    cudnnHandle_t      handle,
    cudnnRNNDescriptor_t  rnnDesc,
    int                *recProjSize,
    int                *outProjSize)

```

**(New for 7.1)**

This function retrieves the current RNN “projection” parameters. By default the projection feature is disabled so invoking this function immediately after `cudnnSetRNNDescriptor()` will yield `recProjSize` equal to `hiddenSize` and `outProjSize` set to zero. The `cudnnSetRNNProjectionLayers()` method enables the RNN projection.

**Parameters****handle**

*Input.* Handle to a previously created cuDNN library descriptor.

**rnnDesc**

*Input.* A previously created and initialized RNN descriptor.

**recProjSize**

*Output.* Pointer where the “recurrent” projection size should be stored.

**outProjSize**

*Output.* Pointer where the “output” projection size should be stored.

**Returns****CUDNN\_STATUS\_SUCCESS**

RNN projection parameters were retrieved successfully.

**CUDNN\_STATUS\_BAD\_PARAM**

A NULL pointer was passed to the function.

## 4.136. cudnnGetRNNTrainingReserveSize

```

cudnnStatus_t cudnnGetRNNTrainingReserveSize(
    cudnnHandle_t      handle,
    const cudnnRNNDescriptor_t  rnnDesc,
    const int          seqLength,
    const cudnnTensorDescriptor_t *xDesc,
    size_t             *sizeInBytes)

```

This function is used to query the amount of reserved space required for training the RNN described by **rnnDesc** with inputs dimensions defined by **xDesc**. The same reserved space buffer must be passed to **cudnnRNNForwardTraining**, **cudnnRNNBackwardData** and **cudnnRNNBackwardWeights**. Each of these calls overwrites the contents of the reserved space, however it can safely be backed up and restored between calls if reuse of the memory is desired.

**Parameters****handle***Input.* Handle to a previously created cuDNN library descriptor.**rnnDesc***Input.* A previously initialized RNN descriptor.**seqLength***Input.* Number of iterations to unroll over. The value of this **seqLength** must not exceed the value that was used in **cudnnGetRNNWorkspaceSize()** function for querying the workspace size required to execute the RNN.**xDesc***Input.* An array of tensor descriptors describing the input to each recurrent iteration (one descriptor per iteration). The first dimension (batch size) of the tensors may decrease from element **n** to element **n+1** but may not increase. Each tensor descriptor must have the same second dimension (vector length).**sizeInBytes***Output.* Minimum amount of GPU memory needed as reserve space to be able to train an RNN with the specified descriptor and input tensors.

The possible error values returned by this function and their meanings are listed below.

**Returns****CUDNN\_STATUS\_SUCCESS**

The query was successful.

**CUDNN\_STATUS\_BAD\_PARAM**

At least one of the following conditions are met:

- ▶ The descriptor **rnnDesc** is invalid.
- ▶ At least one of the descriptors in **xDesc** is invalid.
- ▶ The descriptors in **xDesc** have inconsistent second dimensions, strides or data types.
- ▶ The descriptors in **xDesc** have increasing first dimensions.
- ▶ The descriptors in **xDesc** is not fully packed.

**CUDNN\_STATUS\_NOT\_SUPPORTED**

The the data types in tensors described by **xDesc** is not supported.

## 4.137. cudnnGetRNNWorkspaceSize

```

cudnnStatus_t cudnnGetRNNWorkspaceSize(
    cudnnHandle_t          handle,
    const cudnnRNNDescriptor_t  rnnDesc,
    const int              seqLength,
    const cudnnTensorDescriptor_t *xDesc,
    size_t                 *sizeInBytes)

```

This function is used to query the amount of work space required to execute the RNN described by **rnnDesc** with inputs dimensions defined by **xDesc**.

**Parameters****handle**

*Input.* Handle to a previously created cuDNN library descriptor.

**rnnDesc**

*Input.* A previously initialized RNN descriptor.

**seqLength**

*Input.* Number of iterations to unroll over. Workspace that is allocated, based on the size this function provides, cannot be used for sequences longer than **seqLength**.

**xDesc**

*Input.* An array of tensor descriptors describing the input to each recurrent iteration (one descriptor per iteration). The first dimension (batch size) of the tensors may decrease from element **n** to element **n+1** but may not increase. For example, if you have multiple time series in a batch, they can be different lengths. This dimension is the batch size for the particular iteration of the sequence, and so it should decrease when a sequence in the batch has terminated.

Each tensor descriptor must have the same second dimension (vector length).

**sizeInBytes**

*Output.* Minimum amount of GPU memory needed as workspace to be able to execute an RNN with the specified descriptor and input tensors.

The possible error values returned by this function and their meanings are listed below.

**Returns****CUDNN\_STATUS\_SUCCESS**

The query was successful.

**CUDNN\_STATUS\_BAD\_PARAM**

At least one of the following conditions are met:

- ▶ The descriptor **rnnDesc** is invalid.
- ▶ At least one of the descriptors in **xDesc** is invalid.
- ▶ The descriptors in **xDesc** have inconsistent second dimensions, strides or data types.
- ▶ The descriptors in **xDesc** have increasing first dimensions.
- ▶ The descriptors in **xDesc** is not fully packed.

**CUDNN\_STATUS\_NOT\_SUPPORTED**

The data types in tensors described by **xDesc** is not supported.

## 4.138. cudnnGetSeqDataDescriptor

```

cudnnStatus_t cudnnGetSeqDataDescriptor(
    const cudnnSeqDataDescriptor_t seqDataDesc,
    cudnnDataType_t *dataType,
    int *nbDims,
    int nbDimsRequested,
    int dimA[],
    cudnnSeqDataAxis_t axes[],
    size_t *seqLengthArraySize,
    size_t seqLengthSizeRequested,
    int seqLengthArray[],
    void *paddingFill);

```

This function returns the current values stored in a previously initialized sequence data descriptor.

**Parameters:**

Parameter	Input / Output	Description
seqDataDesc	Input	A sequence data descriptor whose present value is requested.
dataType	Output	The data type of the sequence data.
nbDims	Output	Number of dimensions.
nbDimsRequested	Input	Number of elements of <b>dimA</b> (the axes array) requested. Only the first <b>nbDimsRequested</b> elements or <b>nbDims</b> elements, whichever is smaller, is reported.
dimA[]	Output	Size of the axes dimensions.
axes[]	Output	Axes, in the order of outermost to innermost dimension.
seqLengthArraySize	Output	Length of <b>seqLengthArray</b> .

seqLengthSizeRequested	Input	Number of elements of <code>seqLengthArray</code> requested. Only the first <code>seqLengthArraySize</code> elements, or <code>seqLengthSizeRequested</code> elements, whichever is smaller, is reported.
seqLengthArray[]	Output	Length of each sequence.
paddingFill	Output	Value used for filling the padding elements in the buffer.

**Returns:**

Return Value	Description
CUDNN_STATUS_SUCCESS	The requested values were obtained successfully.
CUDNN_STATUS_BAD_PARAM	Any of the below is true for the input arguments: - <code>seqDataDesc</code> is NULL. - <code>nbDimsRequested</code> is not positive. - <code>seqLengthSizeRequested</code> is larger than <code>seqLengthArraySize</code> <code>dimA[CUDNN_SEQDATA_BATCH_DIM] * dimA[CUDNN_SEQDATA_BEAM_DIM]</code>
CUDNN_STATUS_NOT_SUPPORTED	A value not supported is encountered. For example, the <code>nbDimsRequested</code> is larger than <code>CUDNN_SEQDATA_DIM_COUNT</code> . See <code>cudaSeqDataAxis_t</code> .
CUDNN_STATUS_INTERNAL_ERROR	Encountered an invalid field value in <code>seqDataDesc</code> .

## 4.139. cudnnGetStream

```

cudaStatus_t cudnnGetStream(
    cudnnHandle_t handle,
    cudaStream_t *streamId)

```

This function retrieves the user CUDA stream programmed in the cuDNN handle. When the user's CUDA stream was not set in the cuDNN handle, this function reports the null-stream.

**Parameters****handle**

*Input.* Pointer to the cuDNN handle.

**streamID**

*Output.* Pointer where the current CUDA stream from the cuDNN handle should be stored.

**Returns****CUDNN\_STATUS\_BAD\_PARAM**

Invalid (NULL) handle.

**CUDNN\_STATUS\_SUCCESS**

The stream identifier was retrieved successfully.

## 4.140. cudnnGetTensor4dDescriptor

```

cudnnStatus_t cudnnGetTensor4dDescriptor(
    const cudnnTensorDescriptor_t tensorDesc,
    cudnnDataType_t      *dataType,
    int                   *n,
    int                   *c,
    int                   *h,
    int                   *w,
    int                   *nStride,
    int                   *cStride,
    int                   *hStride,
    int                   *wStride)

```

This function queries the parameters of the previously initialized Tensor4D descriptor object.

**Parameters****tensorDesc**

*Input.* Handle to a previously initialized tensor descriptor.

**dataType**

*Output.* Data type.

**n**

*Output.* Number of images.

**c**

*Output.* Number of feature maps per image.

**h**

*Output.* Height of each feature map.

**w**

*Output.* Width of each feature map.

**nStride**

*Output.* Stride between two consecutive images.

**cStride**

*Output.* Stride between two consecutive feature maps.

**hStride**

*Output.* Stride between two consecutive rows.

**wStride**

*Output.* Stride between two consecutive columns.

The possible error values returned by this function and their meanings are listed below.

**Returns**



**CUDNN\_STATUS\_SUCCESS**

The operation succeeded.

## 4.141. cudnnGetTensorNdDescriptor

```

cudnnStatus_t cudnnGetTensorNdDescriptor(
    const cudnnTensorDescriptor_t  tensorDesc,
    int                             nbDimsRequested,
    cudnnDataType_t                *dataType,
    int                             *nbDims,
    int                             dimA[],
    int                             strideA[])

```

This function retrieves values stored in a previously initialized Tensor descriptor object.

### Parameters

#### **tensorDesc**

*Input.* Handle to a previously initialized tensor descriptor.

#### **nbDimsRequested**

*Input.* Number of dimensions to extract from a given tensor descriptor. It is also the minimum size of the arrays **dimA** and **strideA**. If this number is greater than the resulting **nbDims[0]**, only **nbDims[0]** dimensions will be returned.

#### **datatype**

*Output.* Data type.

#### **nbDims**

*Output.* Actual number of dimensions of the tensor will be returned in **nbDims[0]**.

#### **dimA**

*Output.* Array of dimension of at least **nbDimsRequested** that will be filled with the dimensions from the provided tensor descriptor.

#### **strideA**

*Input.* Array of dimension of at least **nbDimsRequested** that will be filled with the strides from the provided tensor descriptor.

The possible error values returned by this function and their meanings are listed below.

### Returns

#### **CUDNN\_STATUS\_SUCCESS**

The results were returned successfully.

#### **CUDNN\_STATUS\_BAD\_PARAM**

Either **tensorDesc** or **nbDims** pointer is NULL.

## 4.142. cudnnGetTensorSizeInBytes

```

cudnnStatus_t cudnnGetTensorSizeInBytes(

```

```
const cudnnTensorDescriptor_t  tensorDesc,
size_t                          *size)
```

This function returns the size of the tensor in memory in respect to the given descriptor. This function can be used to know the amount of GPU memory to be allocated to hold that tensor.

### Parameters

#### tensorDesc

*Input.* Handle to a previously initialized tensor descriptor.

#### size

*Output.* Size in bytes needed to hold the tensor in GPU memory.

The possible error values returned by this function and their meanings are listed below.

### Returns

#### CUDNN\_STATUS\_SUCCESS

The results were returned successfully.

## 4.143. cudnnGetTensorTransformDescriptor

```
cudnnStatus_t cudnnGetTensorTransformDescriptor(
cudnnTensorTransformDescriptor_t transformDesc,
uint32_t nbDimsRequested,
cudnnTensorFormat_t *destFormat,
int32_t padBeforeA[],
int32_t padAfterA[],
uint32_t foldA[],
cudnnFoldingDirection_t *direction);
```

This function returns the values stored in a previously initialized Tensor transform descriptor.

### Parameters:

Parameter	Input / Output	Description
transformDesc	Input	A previously initialized Tensor transform descriptor.
nbDimsRequested	Input	The number of dimensions to consider. See also <a href="https://docs.nvidia.com/deeplearning/sdk/cudnn-developer-guide/index.html#tensor-descriptor">https://docs.nvidia.com/deeplearning/sdk/cudnn-developer-guide/index.html#tensor-descriptor</a>
destFormat	Output	The transform format that will be returned.
padBeforeA[]	Output	An array filled with the amount of padding to add before each dimension. The dimension of this <code>padBeforeA[]</code> parameter equal to <code>nbDimsRequested</code> .
padAfterA[]	Output	An array filled with the amount of padding to add after each dimension.

		The dimension of this <code>padBeforeA[]</code> parameter is equal to <code>nbDimsRequested</code> .
<code>foldA[]</code>	Output	An array that was filled with the folding parameters for each spatial dimension. The dimension of this <code>foldA[]</code> array is <code>nbDimsRequested - 2</code> .
<code>direction</code>	Output	The setting that selects folding or unfolding. See <a href="#"><code>cudaFoldingDirection_t</code></a> .

**Returns:**

Return Value	Description
<code>CUDNN_STATUS_SUCCESS</code>	The results were obtained successfully.
<code>CUDNN_STATUS_BAD_PARAM</code>	If <code>transformDesc</code> is NULL, or if <code>nbDimsRequested</code> is less than 3 or greater than <code>CUDNN_DIM_MAX</code> .

## 4.144. `cudaGetVersion`

```
size_t cudaGetVersion()
```

This function returns the version number of the cuDNN Library. It returns the `CUDNN_VERSION` define present in the `cuda.h` header file. Starting with release R2, the routine can be used to identify dynamically the current cuDNN Library used by the application. The define `CUDNN_VERSION` can be used to have the same application linked against different cuDNN versions using conditional compilation statements.

## 4.145. `cudaIm2Col`

```
cudaStatus_t cudaIm2Col(
    cudaHandle_t          handle,
    cudaTensorDescriptor_t srcDesc,
    const void           *srcData,
    cudaFilterDescriptor_t filterDesc,
    cudaConvolutionDescriptor_t convDesc,
    void                 *colBuffer)
```

This function constructs the A matrix necessary to perform a forward pass of GEMM convolution. This A matrix has a height of `batch_size*y_height*y_width` and width of `input_channels*filter_height*filter_width`, where `batch_size` is `xDesc`'s first dimension, `y_height/y_width` are computed from `cudaGetConvolutionNdForwardOutputDim()`, `input_channels` is `xDesc`'s second dimension, `filter_height/filter_width` are `wDesc`'s third and fourth dimension. The A matrix is stored in format HW-fully-packed in GPU memory.

**Parameters****handle**

*Input.* Handle to a previously created cuDNN context.

**srcDesc**

*Input.* Handle to a previously initialized tensor descriptor.

**srcData**

*Input.* Data pointer to GPU memory associated with the input tensor descriptor.

**filterDesc**

*Input.* Handle to a previously initialized filter descriptor.

**convDesc**

*Input.* Handle to a previously initialized convolution descriptor.

**colBuffer**

*Output.* Data pointer to GPU memory storing the output matrix.

**Returns****CUDNN\_STATUS\_BAD\_PARAM**

srcData or colBuffer is NULL.

**CUDNN\_STATUS\_NOT\_SUPPORTED**

Any of srcDesc, filterDesc, convDesc has dataType of CUDNN\_DATA\_INT8, CUDNN\_DATA\_INT8x4, CUDNN\_DATA\_INT8, or CUDNN\_DATA\_INT8x4 convDesc has groupCount larger than 1.

**CUDNN\_STATUS\_EXECUTION\_FAILED**

The cuda kernel execution was unsuccessful.

**CUDNN\_STATUS\_SUCCESS**

The output data array is successfully generated.

## 4.146. cudnnInitTransformDest

```

cudnnStatus_t cudnnInitTransformDest(
    const cudnnTensorTransformDescriptor_t transformDesc,
    const cudnnTensorDescriptor_t srcDesc,
    cudnnTensorDescriptor_t destDesc,
    size_t *destSizeInBytes);

```

This function initializes and returns a destination Tensor descriptor **destDesc** for Tensor transform operations. The initialization is done with the desired parameters described in the transform descriptor **cudnnTensorDescriptor\_t**.



The returned Tensor descriptor will be packed.

**Parameters:**

Parameter	Input / Output	Description
transformDesc	Input	Handle to a previously initialized Tensor transform descriptor.

srcDesc	Input	Handle to a previously initialized Tensor descriptor.
destDesc	Output	Handle of the Tensor descriptor that will be initialized and returned.
destSizeInBytes	Output	A pointer to hold the size, in bytes, of the new Tensor.

**Returns:**

Return Value	Description
CUDNN_STATUS_SUCCESS	The Tensor descriptor was initialized successfully.
CUDNN_STATUS_BAD_PARAM	If either <code>srcDesc</code> or <code>destDesc</code> is NULL, or if the Tensor descriptor's <code>nbDims</code> is incorrect.
CUDNN_STATUS_NOT_SUPPORTED	If the provided configuration is not 4D.
CUDNN_STATUS_EXECUTION_FAILED	Function failed to launch on the GPU.

## 4.147. cudnnLRNCrossChannelBackward

```

cudnnStatus_t cudnnLRNCrossChannelBackward(
    cudnnHandle_t          handle,
    cudnnLRNDescriptor_t  normDesc,
    cudnnLRNMode_t        lrnMode,
    const void             *alpha,
    const cudnnTensorDescriptor_t yDesc,
    const void             *y,
    const cudnnTensorDescriptor_t dyDesc,
    const void             *dy,
    const cudnnTensorDescriptor_t xDesc,
    const void             *x,
    const void             *beta,
    const cudnnTensorDescriptor_t dxDesc,
    void                   *dx)

```

This function performs the backward LRN layer computation.



Supported formats are: positive-strided, NCHW for 4D x and y, and only NCDHW DHW-packed for 5D (for both x and y). Only non-overlapping 4D and 5D tensors are supported.

**Parameters****handle**

*Input.* Handle to a previously created cuDNN library descriptor.

**normDesc**

*Input.* Handle to a previously initialized LRN parameter descriptor.

**lrnMode**

*Input.* LRN layer mode of operation. Currently only CUDNN\_LRN\_CROSS\_CHANNEL\_DIM1 is implemented. Normalization is performed along the tensor's `dimA[1]`.

**alpha, beta**

*Input.* Pointers to scaling factors (in host memory) used to blend the layer output value with prior value in the destination tensor as follows:  $\text{dstValue} = \text{alpha}[0] * \text{resultValue} + \text{beta}[0] * \text{priorDstValue}$ . Please refer to this section for additional details.

**yDesc, y**

*Input.* Tensor descriptor and pointer in device memory for the layer's y data.

**dyDesc, dy**

*Input.* Tensor descriptor and pointer in device memory for the layer's input cumulative loss differential data dy (including error backpropagation).

**xDesc, x**

*Input.* Tensor descriptor and pointer in device memory for the layer's x data. Note that these values are not modified during backpropagation.

**dxDesc, dx**

*Output.* Tensor descriptor and pointer in device memory for the layer's resulting cumulative loss differential data dx (including error backpropagation).

Possible error values returned by this function and their meanings are listed below.

**Returns****CUDNN\_STATUS\_SUCCESS**

The computation was performed successfully.

**CUDNN\_STATUS\_BAD\_PARAM**

At least one of the following conditions are met:

- ▶ One of the tensor pointers **x**, **y** is NULL.
- ▶ Number of input tensor dimensions is 2 or less.
- ▶ LRN descriptor parameters are outside of their valid ranges.
- ▶ One of tensor parameters is 5D but is not in NCDHW DHW-packed format.

**CUDNN\_STATUS\_NOT\_SUPPORTED**

The function does not support the provided configuration. See the following for some examples of non-supported configurations:

- ▶ Any of the input tensor datatypes is not the same as any of the output tensor datatype.
- ▶ Any pairwise tensor dimensions mismatch for x,y,dx,dy.
- ▶ Any tensor parameters strides are negative.

## 4.148. cudnnLRNCrossChannelForward

```

cudnnStatus_t cudnnLRNCrossChannelForward(
    cudnnHandle_t          handle,
    cudnnLRNDescriptor_t   normDesc,
    cudnnLRNMode_t         lrnMode,

```

```

const void          *alpha,
const cudnnTensorDescriptor_t xDesc,
const void          *x,
const void          *beta,
const cudnnTensorDescriptor_t yDesc,
void               *y)

```

This function performs the forward LRN layer computation.



Supported formats are: positive-strided, NCHW for 4D  $x$  and  $y$ , and only NCDHW DHW-packed for 5D (for both  $x$  and  $y$ ). Only non-overlapping 4D and 5D tensors are supported.

## Parameters

### handle

*Input.* Handle to a previously created cuDNN library descriptor.

### normDesc

*Input.* Handle to a previously initialized LRN parameter descriptor.

### lrnMode

*Input.* LRN layer mode of operation. Currently only CUDNN\_LRN\_CROSS\_CHANNEL\_DIM1 is implemented. Normalization is performed along the tensor's  $\text{dimA}[1]$ .

### alpha, beta

*Input.* Pointers to scaling factors (in host memory) used to blend the layer output value with prior value in the destination tensor as follows:  $\text{dstValue} = \text{alpha}[0] * \text{resultValue} + \text{beta}[0] * \text{priorDstValue}$ . [Please refer to this section for additional details.](#)

### xDesc, yDesc

*Input.* Tensor descriptor objects for the input and output tensors.

### x

*Input.* Input tensor data pointer in device memory.

### y

*Output.* Output tensor data pointer in device memory.

Possible error values returned by this function and their meanings are listed below.

## Returns

### CUDNN\_STATUS\_SUCCESS

The computation was performed successfully.

### CUDNN\_STATUS\_BAD\_PARAM

At least one of the following conditions are met:

- ▶ One of the tensor pointers  $\mathbf{x}$ ,  $\mathbf{y}$  is NULL.
- ▶ Number of input tensor dimensions is 2 or less.
- ▶ LRN descriptor parameters are outside of their valid ranges.

- ▶ One of tensor parameters is 5D but is not in NCDHW DHW-packed format.

#### CUDNN\_STATUS\_NOT\_SUPPORTED

The function does not support the provided configuration. See the following for some examples of non-supported configurations:

- ▶ Any of the input tensor datatypes is not the same as any of the output tensor datatype.
- ▶ x and y tensor dimensions mismatch.
- ▶ Any tensor parameters strides are negative.

## 4.149. cudnnMakeFusedOpsPlan

```

cudnnStatus_t cudnnMakeFusedOpsPlan(
    cudnnHandle_t handle,
    cudnnFusedOpsPlan_t plan,
    const cudnnFusedOpsConstParamPack_t constPack,
    size_t *workspaceSizeInBytes);

```

This function determines the optimum kernel to execute, and the workspace size the user should allocate, prior to the actual execution of the fused operations by `cudnnFusedOpsExecute`.

#### Parameters:

Parameter	Input / Output	Description
handle	Input	Pointer to the cuDNN library context.
plan	Input	Pointer to a previously-created and initialized plan descriptor.
constPack	Input	Pointer to the descriptor to the const parameters pack.
workspaceSizeInBytes	Output	The amount of workspace size the user should allocate for the execution of this plan.

#### Returns:

Return Value	Description
CUDNN_STATUS_BAD_PARAM	If any of the inputs is NULL, or if the type of <code>cudnnFusedOps_t</code> in the <code>constPack</code> descriptor is unsupported.
CUDNN_STATUS_SUCCESS	The function executed successfully.

## 4.150. cudnnMultiHeadAttnBackwardData

```

cudnnStatus_t cudnnMultiHeadAttnBackwardData(
    cudnnHandle_t handle,
    const cudnnAttnDescriptor_t attnDesc,
    const int *loWinIdx,
    const int *hiWinIdx,

```



```

const int *seqLengthArrayDQDO,
const int *seqLengthArrayDKDV,
const cudnnSeqDataDescriptor_t doDesc,
const void *dout,
const cudnnSeqDataDescriptor_t dqDesc,
void *dqueries,
const void *queries,
const cudnnSeqDataDescriptor_t dkDesc,
void *dkeys,
const void *keys,
const cudnnSeqDataDescriptor_t dvDesc,
void *dvalues,
const void *values,
size_t weightSizeInBytes,
const void *w,
size_t workSpaceSizeInBytes,
void *workSpace,
size_t reserveSpaceSizeInBytes,
void *reserveSpace);

```

This function computes the data gradients with backpropagation.

#### Parameters:

Parameter	Input / Output	Description
handle	Input	A cuDNN context handle.
attnDesc	Input	A previously initialized multi-head attention descriptor.
loWinIdx, hiWinIdx	Input	An array of lower (inclusive) and upper (exclusive) key and value time steps windows.
seqLengthArrayDQDO	Input	Sequence lengths of queries and output sequences data.
seqLengthArrayDKDV	Input	Sequence lengths of keys and values sequences data.
doDesc	Input	Descriptor for output gradient sequence data.
dout	Input	Output gradient data in device memory.
dqDesc	Input	Descriptor for queries sequence data.
dqueries	Output	Queries gradient data in device memory.
queries	Input	Queries data in device memory.
dkDesc	Input	Descriptor for the keys vectors.
dkeys	Output	Keys gradient data in device memory.
keys	Input	Keys data in device memory.
dvDesc	Input	Descriptor for the values vectors.
dvalues	Output	Values gradient data in device memory.
values	Input	Values data in device memory.
weightSizeInBytes	Input	Pointer to a location, in host memory, where the attention weight sizes (in bytes) are stored.

w	Input	Weight data in device memory.
workSpaceSizeInBytes	Input	Pointer to a location, in host memory, of the workspace size (in bytes). For inference and training.
workSpace	Input	Workspace data in device memory.
reserveSpaceSizeInBytes	Input	Pointer to a location, in host memory, of the reserve space size (in bytes). For training.
reserveSpace	Input/Output	Reserve space data in device memory.

**Returns:**

Return Value	Description
CUDNN_STATUS_SUCCESS	The forward calculation is successful.
CUDNN_STATUS_EXECUTION_FAILED	Failed to launch the kernel, or other kernel errors.

## 4.151. cudnnMultiHeadAttnBackwardWeights

```

cudnnStatus_t cudnnMultiHeadAttnBackwardWeights(
    cudnnHandle_t handle,
    const cudnnAttnDescriptor_t attnDesc,
    cudnnWgradMode_t addGrad,
    const cudnnSeqDataDescriptor_t qDesc,
    const void *queries,
    const cudnnSeqDataDescriptor_t kDesc,
    const void *keys,
    const cudnnSeqDataDescriptor_t vDesc,
    const void *values,
    const cudnnSeqDataDescriptor_t doDesc,
    const void *dout,
    size_t weightSizeInBytes,
    const void *w,
    void *dw,
    size_t workSpaceSizeInBytes,
    void *workSpace,
    size_t reserveSpaceSizeInBytes,
    void *reserveSpace);

```

This function computes the weight gradients with backpropagation.

**Parameters:**

Parameter	Input / Output	Description
handle	Input	A cuDNN context handle.
attnDesc	Input	A previously initialized multi-head attention descriptor.
addGrad	Input	Weight gradient output mode. See <a href="#">cudnnWgradMode_t</a> <link>.
qDesc	Input	Descriptor of the query sequence data.
queries	Input	Query data in device memory.
kDesc	Input	Descriptor for the keys sequence data.

keys	Input	Keys data in device memory.
vDesc	Input	Descriptor for the values sequence data.
values	Input	Values data in device memory.
doDesc	Input	Descriptor for the output gradient sequence data.
dout	Input	Output gradient data in device memory.
weightSizeInBytes	Input	Pointer to a location, in host memory, where the attention weight sizes (in bytes) are stored.
w	Input	Pointer to the weight buffer address.
dw	Output	Weight gradient data in device memory.
workSpaceSizeInBytes	Input	Pointer to a location, in host memory, of the workspace size (in bytes). For inference and training.
workSpace	Input	Workspace data in device memory.
reserveSpaceSizeInBytes	Input	Pointer to a location, in host memory, of the reserve space size (in bytes). For training.
reserveSpace	Input	Reserve space data in device memory.

**Returns:**

Return Value	Description
CUDNN_STATUS_SUCCESS	The forward calculation is successful.
CUDNN_STATUS_EXECUTION_FAILED	Failed to launch the kernel, or other kernel errors.

## 4.152. cudnnMultiHeadAttnForward

```

cudnnStatus_t cudnnMultiHeadAttnForward(
    cudnnHandle_t handle,
    const cudnnAttnDescriptor_t attnDesc,
    int currIdx,
    const int *loWinIdx,
    const int *hiWinIdx,
    const int *seqLengthArrayQRO,
    const int *seqLengthArrayKV,
    const cudnnSeqDataDescriptor_t qDesc,
    const void *queries,
    const void *residuals,
    const cudnnSeqDataDescriptor_t kDesc,
    const void *keys,
    const cudnnSeqDataDescriptor_t vDesc,
    const void *values,
    const cudnnSeqDataDescriptor_t oDesc,
    void *out,
    size_t weightSizeInBytes,
    const void *w,
    size_t workSpaceSizeInBytes,
    void *workSpace,
    size_t reserveSpaceSizeInBytes,
    void *reserveSpace);

```

The function `cudaMultiHeadAttnForward()` performs the multi-head attention response computation, as described in the paper [Attention Is All You Need](#).

**Parameters:**

Parameter	Input / Output	Description
handle	Input	A cuDNN context handle.
attnDesc	Input	A previously initialized multi-head attention descriptor.
currIdx	Input	Output timestep(s) to compute. < 0 for the training mode, and >=0 for the inference mode.
loWinIdx, hiWinIdx	Input	An array of lower (inclusive) and upper (exclusive) key and value time steps windows.
seqLengthArrayQRO	Input	Length of each sequence of the query, residual, and output data.
seqLengthArrayKV	Input	Length of each sequence of the key and value data.
qDesc	Input	Descriptor for the queries and residual sequence data.
queries	Input	Queries data in device memory.
residuals	Input	Residual data in device memory. NULL if no residual connection.
kDesc	Input	Descriptor for the keys sequence data.
keys	Input	Keys data in device memory.
vDesc	Input	Descriptor for the values sequence data.
values	Input	Values data in device memory.
oDesc	Input	Descriptor for the multi-head attention output sequence data.
out	Output	Output data in device memory.
weightSizeInBytes	Input	Pointer to a location, in host memory, where the attention weight sizes (in bytes) are stored.
w	Input	Weight data in device memory.
workSpaceSizeInBytes	Input	Pointer to a location, in host memory, of the workspace size (in bytes). For inference and training.
workSpace	Input	Workspace data in device memory.
reserveSpaceSizeInBytes	Input	Pointer to a location, in host memory, of the reserve space size (in bytes). For training.
reserveSpace	Input/Output	Reserve space data in device memory. If this is NULL it is inference mode, otherwise it is training.

**Returns:**

Return Value	Description
CUDNN_STATUS_SUCCESS	The forward calculation is successful.
CUDNN_STATUS_EXECUTION_FAILED	Failed to launch the kernel, or other kernel errors.
CUDNN_STATUS_INTERNAL_ERROR	Inconsistent internal state(s) encountered.
CUDNN_STATUS_BAD_PARAM	An invalid or incompatible parameter value is encountered. For example: <ul style="list-style-type: none"> <li>- Any required input pointers are NULL</li> <li>- currIdx is out of bound or is negative in inference mode (indicated by reserveSpace == NULL)</li> <li>- The descriptor value for attention, query, key, value, and output are incompatible with one another.</li> <li>- Dropout is enabled but with dropout rate &gt;= 1.</li> </ul>
CUDNN_STATUS_NOT_SUPPORTED	An unsupported parameter value is encountered. For example: <ul style="list-style-type: none"> <li>- A combination of <code>dataType</code> and <code>mathPrec</code> that is not supported.</li> </ul>
CUDNN_STATUS_ALLOC_FAILED	Not enough device share memory to launch kernel.

## 4.153. cudnnOpTensor

```

cudnnStatus_t cudnnOpTensor(
    cudnnHandle_t          handle,
    const cudnnOpTensorDescriptor_t opTensorDesc,
    const void             *alpha1,
    const cudnnTensorDescriptor_t aDesc,
    const void             *A,
    const void             *alpha2,
    const cudnnTensorDescriptor_t bDesc,
    const void             *B,
    const void             *beta,
    const cudnnTensorDescriptor_t cDesc,
    void                   *C)

```

This function implements the equation  $C = \text{op}(\alpha_1[0] * A, \alpha_2[0] * B) + \beta[0] * C$ , given the Tensors **A**, **B**, and **C** and the scaling factors `alpha1`, `alpha2`, and `beta`. The **op** to use is indicated by the descriptor `cudnnOpTensorDescriptor_t`, i.e., the type of `opTensorDesc`. Currently-supported ops are listed by the `cudnnOpTensorOp_t` enum.

The following restrictions on the input and destination Tensors apply:

- ▶ Each dimension of the input Tensor **A** must match the corresponding dimension of the destination Tensor **C**, and each dimension of the input Tensor **B** must match the corresponding dimension of the destination Tensor **C** or must be equal to 1. In the latter case, the same value from the input Tensor **B** for those dimensions will be used to blend into the **C** Tensor.
- ▶ The data types of the input Tensors **A** and **B**, and the destination Tensor **C**, must satisfy the table [Table 14](#).

Table 14 Supported Datatypes

opTensorCompType in opTensorDesc	A	B	C (destination)
FLOAT	FLOAT	FLOAT	FLOAT
FLOAT	INT8	INT8	FLOAT
FLOAT	HALF	HALF	FLOAT
DOUBLE	DOUBLE	DOUBLE	DOUBLE
FLOAT	FLOAT	FLOAT	HALF
FLOAT	HALF	HALF	HALF
FLOAT	INT8	INT8	INT8
FLOAT	FLOAT	FLOAT	INT8



All Tensor formats up to dimension five (5) are supported. This routine does not support Tensor formats beyond these dimensions.

### Parameters

#### handle

*Input.* Handle to a previously created cuDNN context.

#### opTensorDesc

*Input.* Handle to a previously initialized op Tensor descriptor.

#### alpha1, alpha2, beta

*Input.* Pointers to scaling factors (in host memory) used to blend the source value with prior value in the destination Tensor as indicated by the above op equation. [Refer to this section for additional details.](#)

#### aDesc, bDesc, cDesc

*Input.* Handle to a previously initialized Tensor descriptor.

#### A, B

*Input.* Pointer to data of the Tensors described by the **aDesc** and **bDesc** descriptors, respectively.

#### C

*Input/Output.* Pointer to data of the Tensor described by the **cDesc** descriptor.

The possible error values returned by this function and their meanings are listed below.

### Returns

#### CUDNN\_STATUS\_SUCCESS

The function executed successfully.

**CUDNN\_STATUS\_NOT\_SUPPORTED**

The function does not support the provided configuration. See the following for some examples of non-supported configurations:

- ▶ The dimensions of the bias Tensor and the output Tensor dimensions are above 5.
- ▶ `opTensorCompType` is not set as stated above.

**CUDNN\_STATUS\_BAD\_PARAM**

The data type of the destination Tensor **C** is unrecognized, or the restrictions on the input and destination Tensors, stated above, are not met.

**CUDNN\_STATUS\_EXECUTION\_FAILED**

The function failed to launch on the GPU.

## 4.154. cudnnPoolingBackward

```

cudnnStatus_t cudnnPoolingBackward(
    cudnnHandle_t          handle,
    const cudnnPoolingDescriptor_t poolingDesc,
    const void             *alpha,
    const cudnnTensorDescriptor_t yDesc,
    const void             *y,
    const cudnnTensorDescriptor_t dyDesc,
    const void             *dy,
    const cudnnTensorDescriptor_t xDesc,
    const void             *xData,
    const void             *beta,
    const cudnnTensorDescriptor_t dxDesc,
    void                   *dx)

```

This function computes the gradient of a pooling operation.

As of cuDNN version 6.0, a deterministic algorithm is implemented for max backwards pooling. This algorithm can be chosen via the pooling mode enum of `poolingDesc`. The deterministic algorithm has been measured to be up to 50% slower than the legacy max backwards pooling algorithm, or up to 20% faster, depending upon the use case.



All tensor formats are supported, best performance is expected when using **HW-packed** tensors. Only 2 and 3 spatial dimensions are allowed

**Parameters****handle**

*Input.* Handle to a previously created cuDNN context.

**poolingDesc**

*Input.* Handle to the previously initialized pooling descriptor.

**alpha, beta**

*Input.* Pointers to scaling factors (in host memory) used to blend the computation result with prior value in the output layer as follows:  $\text{dstValue} = \text{alpha}[0] * \text{result} + \text{beta}[0] * \text{priorDstValue}$ . [Please refer to this section for additional details.](#)

**yDesc**

*Input.* Handle to the previously initialized input tensor descriptor.

**y**

*Input.* Data pointer to GPU memory associated with the tensor descriptor **yDesc**.

**dyDesc**

*Input.* Handle to the previously initialized input differential tensor descriptor.

**dy**

*Input.* Data pointer to GPU memory associated with the tensor descriptor **dyData**.

**xDesc**

*Input.* Handle to the previously initialized output tensor descriptor.

**x**

*Input.* Data pointer to GPU memory associated with the output tensor descriptor **xDesc**.

**dxDesc**

*Input.* Handle to the previously initialized output differential tensor descriptor.

**dx**

*Output.* Data pointer to GPU memory associated with the output tensor descriptor **dxDesc**.

The possible error values returned by this function and their meanings are listed below.

**Returns****CUDNN\_STATUS\_SUCCESS**

The function launched successfully.

**CUDNN\_STATUS\_BAD\_PARAM**

At least one of the following conditions are met:

- ▶ The dimensions **n, c, h, w** of the **yDesc** and **dyDesc** tensors differ.
- ▶ The strides **nStride, cStride, hStride, wStride** of the **yDesc** and **dyDesc** tensors differ.
- ▶ The dimensions **n, c, h, w** of the **dxDesc** and **dyDesc** tensors differ.
- ▶ The strides **nStride, cStride, hStride, wStride** of the **xDesc** and **dxDesc** tensors differ.
- ▶ The **datatype** of the four tensors differ.

**CUDNN\_STATUS\_NOT\_SUPPORTED**

The function does not support the provided configuration. See the following for some examples of non-supported configurations:

- ▶ The **wStride** of input tensor or output tensor is not 1.

**CUDNN\_STATUS\_EXECUTION\_FAILED**

The function failed to launch on the GPU.



## 4.155. cudnnPoolingForward

```

cudnnStatus_t cudnnPoolingForward(
    cudnnHandle_t          handle,
    const cudnnPoolingDescriptor_t poolingDesc,
    const void             *alpha,
    const cudnnTensorDescriptor_t xDesc,
    const void             *x,
    const void             *beta,
    const cudnnTensorDescriptor_t yDesc,
    void                   *y)

```

This function computes pooling of input values (i.e., the maximum or average of several adjacent values) to produce an output with smaller height and/or width.



All tensor formats are supported, best performance is expected when using **HW-packed** tensors. Only 2 and 3 spatial dimensions are allowed.



The dimensions of the output tensor **yDesc** can be smaller or bigger than the dimensions advised by the routine `cudnnGetPooling2dForwardOutputDim` or `cudnnGetPoolingNdForwardOutputDim`.

### Parameters

#### handle

*Input.* Handle to a previously created cuDNN context.

#### poolingDesc

*Input.* Handle to a previously initialized pooling descriptor.

#### alpha, beta

*Input.* Pointers to scaling factors (in host memory) used to blend the computation result with prior value in the output layer as follows:  $\text{dstValue} = \alpha[0] * \text{result} + \beta[0] * \text{priorDstValue}$ . [Refer to this section for additional details.](#)

#### xDesc

*Input.* Handle to the previously initialized input tensor descriptor. Must be of type `FLOAT`, or `DOUBLE`, or `HALF`, or `INT8`. See [cudnnDataType\\_t](#).

#### x

*Input.* Data pointer to GPU memory associated with the tensor descriptor **xDesc**.

#### yDesc

*Input.* Handle to the previously initialized output tensor descriptor. Must be of type `FLOAT`, or `DOUBLE`, or `HALF`, or `INT8`. See [cudnnDataType\\_t](#).

#### y

*Output.* Data pointer to GPU memory associated with the output tensor descriptor **yDesc**.

The possible error values returned by this function and their meanings are listed below.

**Returns****CUDNN\_STATUS\_SUCCESS**

The function launched successfully.

**CUDNN\_STATUS\_BAD\_PARAM**

At least one of the following conditions are met:

- ▶ The dimensions **n**, **c** of the input tensor and output tensors differ.
- ▶ The **datatype** of the input tensor and output tensors differs.

**CUDNN\_STATUS\_NOT\_SUPPORTED**

The function does not support the provided configuration.

**CUDNN\_STATUS\_EXECUTION\_FAILED**

The function failed to launch on the GPU.

## 4.156. cudnnQueryRuntimeError

```

cudnnStatus_t cudnnQueryRuntimeError(
    cudnnHandle_t      handle,
    cudnnStatus_t     *rstatus,
    cudnnErrQueryMode_t mode,
    cudnnRuntimeTag_t *tag)

```

cuDNN library functions perform extensive input argument checking before launching GPU kernels. The last step is to verify that the GPU kernel actually started. When a kernel fails to start, **CUDNN\_STATUS\_EXECUTION\_FAILED** is returned by the corresponding API call. Typically, after a GPU kernel starts, no runtime checks are performed by the kernel itself -- numerical results are simply written to output buffers.

When the **CUDNN\_BATCHNORM\_SPATIAL\_PERSISTENT** mode is selected in **cudnnBatchNormalizationForwardTraining** or **cudnnBatchNormalizationBackward**, the algorithm may encounter numerical overflows where **CUDNN\_BATCHNORM\_SPATIAL** performs just fine albeit at a slower speed. The user can invoke **cudnnQueryRuntimeError** to make sure numerical overflows did not occur during the kernel execution. Those issues are reported by the kernel that performs computations.

**cudnnQueryRuntimeError** can be used in polling and blocking software control flows. There are two polling modes (**CUDNN\_ERRQUERY\_RAWCODE**, **CUDNN\_ERRQUERY\_NONBLOCKING**) and one blocking mode **CUDNN\_ERRQUERY\_BLOCKING**.

**CUDNN\_ERRQUERY\_RAWCODE** reads the error storage location regardless of the kernel completion status. The kernel might not even started and the error storage (allocated per cuDNN handle) might be used by an earlier call.

**CUDNN\_ERRQUERY\_NONBLOCKING** checks if all tasks in the user stream completed. The **cudnnQueryRuntimeError** function will return immediately and report **CUDNN\_STATUS\_RUNTIME\_IN\_PROGRESS** in 'rstatus' if some tasks in the user

stream are pending. Otherwise, the function will copy the remote kernel error code to 'rstatus'.

In the blocking mode (CUDNN\_ERRQUERY\_BLOCKING), the function waits for all tasks to drain in the user stream before reporting the remote kernel error code. The blocking flavor can be further adjusted by calling `cudaSetDeviceFlags` with the `cudaDeviceScheduleSpin`, `cudaDeviceScheduleYield`, or `cudaDeviceScheduleBlockingSync` flag.

CUDNN\_ERRQUERY\_NONBLOCKING and CUDNN\_ERRQUERY\_BLOCKING modes should not be used when the user stream is changed in the cuDNN handle, i.e., `cudaSetStream` is invoked between functions that report runtime kernel errors and the `cudaQueryRuntimeError` function.

The remote error status reported in `rstatus` can be set to: CUDNN\_STATUS\_SUCCESS, CUDNN\_STATUS\_RUNTIME\_IN\_PROGRESS, or CUDNN\_STATUS\_RUNTIME\_FP\_OVERFLOW. The remote kernel error is automatically cleared by `cudaQueryRuntimeError`.



The `cudaQueryRuntimeError` function should be used in conjunction with `cudaBatchNormalizationForwardTraining` and `cudaBatchNormalizationBackward` when the `cudaBatchNormMode_t` argument is CUDNN\_BATCHNORM\_SPATIAL\_PERSISTENT.

## Parameters

### **handle**

*Input.* Handle to a previously created cuDNN context.

### **rstatus**

*Output.* Pointer to the user's error code storage.

### **mode**

*Input.* Remote error query mode.

### **tag**

*Input/Output.* Currently, this argument should be NULL.

The possible error values returned by this function and their meanings are listed below.

## Returns

### **CUDNN\_STATUS\_SUCCESS**

No errors detected (`rstatus` holds a valid value).

### **CUDNN\_STATUS\_BAD\_PARAM**

Invalid input argument.

### **CUDNN\_STATUS\_INTERNAL\_ERROR**

A stream blocking synchronization or a non-blocking stream query failed.

### **CUDNN\_STATUS\_MAPPING\_ERROR**

Device cannot access zero-copy memory to report kernel errors.

## 4.157. cudnnReduceTensor

```

cudnnStatus_t cudnnReduceTensor(
    cudnnHandle_t          handle,
    const cudnnReduceTensorDescriptor_t reduceTensorDesc,
    void*                 *indices,
    size_t                indicesSizeInBytes,
    void*                 *workspace,
    size_t                workspaceSizeInBytes,
    const void*           *alpha,
    const cudnnTensorDescriptor_t aDesc,
    const void*           *A,
    const void*           *beta,
    const cudnnTensorDescriptor_t cDesc,
    void*                 *C)

```

This function reduces tensor **A** by implementing the equation  $C = \alpha * \text{reduce op} (A) + \beta * C$ , given tensors **A** and **C** and scaling factors **alpha** and **beta**. The reduction op to use is indicated by the descriptor **reduceTensorDesc**. Currently-supported ops are listed by the **cudnnReduceTensorOp\_t** enum.

Each dimension of the output tensor **C** must match the corresponding dimension of the input tensor **A** or must be equal to 1. The dimensions equal to 1 indicate the dimensions of **A** to be reduced.

The implementation will generate indices for the min and max ops only, as indicated by the **cudnnReduceTensorIndices\_t** enum of the **reduceTensorDesc**. Requesting indices for the other reduction ops results in an error. The data type of the indices is indicated by the **cudnnIndicesType\_t** enum; currently only the 32-bit (unsigned int) type is supported.

The indices returned by the implementation are not absolute indices but relative to the dimensions being reduced. The indices are also flattened, i.e. not coordinate tuples.

The data types of the tensors **A** and **C** must match if of type double. In this case, **alpha** and **beta** and the computation enum of **reduceTensorDesc** are all assumed to be of type double.

The half and int8 data types may be mixed with the float data types. In these cases, the computation enum of **reduceTensorDesc** is required to be of type float.



Up to dimension 8, all tensor formats are supported. Beyond those dimensions, this routine is not supported

### Parameters

#### **handle**

*Input.* Handle to a previously created cuDNN context.

#### **reduceTensorDesc**

*Input.* Handle to a previously initialized reduce tensor descriptor.

#### **indices**

*Output.* Handle to a previously allocated space for writing indices.

**indicesSizeInBytes**

*Input.* Size of the above previously allocated space.

**workspace**

*Input.* Handle to a previously allocated space for the reduction implementation.

**workspaceSizeInBytes**

*Input.* Size of the above previously allocated space.

**alpha, beta**

*Input.* Pointers to scaling factors (in host memory) used to blend the source value with prior value in the destination tensor as indicated by the above op equation. [Please refer to this section for additional details.](#)

**aDesc, cDesc**

*Input.* Handle to a previously initialized tensor descriptor.

**A**

*Input.* Pointer to data of the tensor described by the **aDesc** descriptor.

**C**

*Input/Output.* Pointer to data of the tensor described by the **cDesc** descriptor.

The possible error values returned by this function and their meanings are listed below.

**Returns****CUDNN\_STATUS\_SUCCESS**

The function executed successfully.

**CUDNN\_STATUS\_NOT\_SUPPORTED**

The function does not support the provided configuration. See the following for some examples of non-supported configurations:

- ▶ The dimensions of the input tensor and the output tensor are above 8.
- ▶ **reduceTensorCompType** is not set as stated above.

**CUDNN\_STATUS\_BAD\_PARAM**

The corresponding dimensions of the input and output tensors all match, or the conditions in the above paragraphs are unmet.

**CUDNN\_INVALID\_VALUE**

The allocations for the indices or workspace are insufficient.

**CUDNN\_STATUS\_EXECUTION\_FAILED**

The function failed to launch on the GPU.

## 4.158. cudnnReorderFilterAndBias

```

cudnnStatus_t cudnnReorderFilterAndBias(
    cudnnHandle_t handle,
    const cudnnFilterDescriptor_t filterDesc,

```

```

cudnnReorderType_t reorderType,
const void *filterData,
void *reorderedFilterData,
int reorderBias,
const void *biasData,
void *reorderedBiasData);

```

This function **cudnnReorderFilterAndBias()** reorders the filter and bias values. It can be used to enhance the inference time by separating the reordering operation from convolution.

For example, convolutions in a neural network of multiple layers can require reordering of kernels at every layer, which can take up a significant fraction of the total inference time. Using this function, the reordering can be done one time on the filter and bias data followed by the convolution operations at the multiple layers, thereby enhancing the inference time.

#### Parameters:

Parameter	Input / Output	Description
filterDesc	Input	Descriptor for the kernel dataset.
reorderType	Input	Setting to either perform reordering or not. See <a href="#">cudnnReorderType_t</a> .
filterData	Input	Pointer to the filter (kernel) data location in the device memory.
reorderedFilterData	Input	Pointer to the location in the device memory where the reordered filter data will be written to, by this function.
reorderBias	Input	If > 0, then reorders the bias data also. If <= 0 then does not perform reordering operation on the bias data.
biasData	Input	Pointer to the bias data location in the device memory.
reorderedBiasData	Input	Pointer to the location in the device memory where the reordered bias data will be written to, by this function.

#### Returns:

Return Value	Description
CUDNN_STATUS_SUCCESS	Reordering was successful.
CUDNN_STATUS_EXECUTION_FAILED	Either the reordering of the filter data or of the bias data failed.

## 4.159. cudnnRestoreAlgorithm

```

cudnnStatus_t cudnnRestoreAlgorithm(
    cudnnHandle_t      handle,
    void*              algoSpace,
    size_t             algoSpaceSizeInBytes,
    cudnnAlgorithmDescriptor_t algoDesc)

```

**(New for 7.1)**

This function reads algorithm metadata from the host memory space provided by the user in `algoSpace`, allowing the user to use the results of RNN finds from previous cuDNN sessions.

**Parameters****handle**

*Input.* Handle to a previously created cuDNN context.

**algoDesc**

*Input.* A previously created algorithm descriptor.

**algoSpace**

*Input.* Pointer to the host memory to be read.

**algoSpaceSizeInBytes**

*Input.* Amount of host memory needed as workspace to be able to hold the metadata from the specified `algoDesc`.

**Returns****CUDNN\_STATUS\_SUCCESS**

The function launched successfully.

**CUDNN\_STATUS\_NOT\_SUPPORTED**

The metadata is from a different cudnn version.

**CUDNN\_STATUS\_BAD\_PARAM**

At least one of the following conditions is met:

- ▶ One of the arguments is null.
- ▶ The metadata is corrupted.

## 4.160. cudnnRestoreDropoutDescriptor

```

cudnnStatus_t cudnnRestoreDropoutDescriptor(
    cudnnDropoutDescriptor_t dropoutDesc,
    cudnnHandle_t             handle,
    float                     dropout,
    void                      *states,
    size_t                    stateSizeInBytes,
    unsigned long long        seed)

```

This function restores a dropout descriptor to a previously saved-off state.

**Parameters****dropoutDesc**

*Input/Output.* Previously created dropout descriptor.

**handle**

*Input.* Handle to a previously created cuDNN context.

**dropout**

*Input.* Probability with which the value from an input tensor is set to 0 when performing dropout.

**states**

*Input.* Pointer to GPU memory that holds random number generator states initialized by a prior call to `cudaDnnSetDropoutDescriptor`.

**stateSizeInBytes**

*Input.* Size in bytes of buffer holding random number generator states.

**seed**

*Input.* Seed used in prior call to `cudaDnnSetDropoutDescriptor` that initialized 'states' buffer. Using a different seed from this has no effect. A change of seed, and subsequent update to random number generator states can be achieved by calling `cudaDnnSetDropoutDescriptor`.

The possible error values returned by this function and their meanings are listed below.

**Returns****CUDNN\_STATUS\_SUCCESS**

The call was successful.

**CUDNN\_STATUS\_INVALID\_VALUE**

States buffer size (as indicated in `stateSizeInBytes`) is too small.

## 4.161. `cudaDnnRNNBackwardData`

```

cudaDnnStatus_t cudaDnnRNNBackwardData(
    cudaDnnHandle_t          handle,
    const cudaDnnRNNDescriptor_t  rnnDesc,
    const int                seqLength,
    const cudaDnnTensorDescriptor_t *yDesc,
    const void               *y,
    const cudaDnnTensorDescriptor_t *dyDesc,
    const void               *dy,
    const cudaDnnTensorDescriptor_t dhyDesc,
    const void               *dhy,
    const cudaDnnTensorDescriptor_t dcyDesc,
    const void               *dcy,
    const cudaDnnFilterDescriptor_t wDesc,
    const void               *w,
    const cudaDnnTensorDescriptor_t hxDesc,
    const void               *hx,
    const cudaDnnTensorDescriptor_t cxDesc,
    const void               *cx,
    const cudaDnnTensorDescriptor_t dxDesc,
    void                     *dx,
    const cudaDnnTensorDescriptor_t dhxDesc,
    void                     *dhx,
    const cudaDnnTensorDescriptor_t dcxDesc,
    void                     *dcx,
    void                     *workspace,
    size_t                   workspaceSizeInBytes,
    const void               *reserveSpace,
    size_t                   reserveSpaceSizeInBytes)

```



This routine executes the recurrent neural network described by `rnnDesc` with output gradients `dy`, `dhy`, `dhc`, weights `w` and input gradients `dx`, `dhx`, `dcx`. `workspace` is required for intermediate storage. The data in `reserveSpace` must have previously been generated by `cudaRNNForwardTraining`. The same `reserveSpace` data must be used for future calls to `cudaRNNBackwardWeights` if they execute on the same input data.

## Parameters

### `handle`

*Input.* Handle to a previously created cuDNN context. See `cudaHandle_t`.

### `rnnDesc`

*Input.* A previously initialized RNN descriptor. See `cudaRNNDesc_t`.

### `seqLength`

*Input.* Number of iterations to unroll over. The value of this `seqLength` must not exceed the value that was used in `cudaGetRNNWorkspaceSize()` function for querying the workspace size required to execute the RNN.

### `yDesc`

*Input.* An array of fully packed tensor descriptors describing the output from each recurrent iteration (one descriptor per iteration). See `cudaTensorDescriptor_t`. The second dimension of the tensor depends on the `direction` argument passed to the `cudaSetRNNDesc` call used to initialize `rnnDesc`:

- ▶ If `direction` is `CUDNN_UNIDIRECTIONAL` the second dimension should match the `hiddenSize` argument passed to `cudaSetRNNDesc`.
- ▶ If `direction` is `CUDNN_BIDIRECTIONAL` the second dimension should match double the `hiddenSize` argument passed to `cudaSetRNNDesc`.

The first dimension of the tensor `n` must match the first dimension of the tensor `n` in `dyDesc`.

### `y`

*Input.* Data pointer to GPU memory associated with the output tensor descriptor `yDesc`.

### `dyDesc`

*Input.* An array of fully packed tensor descriptors describing the gradient at the output from each recurrent iteration (one descriptor per iteration). The second dimension of the tensor depends on the `direction` argument passed to the `cudaSetRNNDesc` call used to initialize `rnnDesc`:

- ▶ If `direction` is `CUDNN_UNIDIRECTIONAL` the second dimension should match the `hiddenSize` argument passed to `cudaSetRNNDesc`.
- ▶ If `direction` is `CUDNN_BIDIRECTIONAL` the second dimension should match double the `hiddenSize` argument passed to `cudaSetRNNDesc`.

The first dimension of the tensor `n` must match the first dimension of the tensor `n` in `dxDesc`.

**dy**

*Input.* Data pointer to GPU memory associated with the tensor descriptors in the array **dyDesc**.

**dhyDesc**

*Input.* A fully packed tensor descriptor describing the gradients at the final hidden state of the RNN. The first dimension of the tensor depends on the **direction** argument passed to the **cudaSetRNNDescriptor** call used to initialize **rnnDesc**:

- ▶ If **direction** is **CUDNN\_UNIDIRECTIONAL** the first dimension should match the **numLayers** argument passed to **cudaSetRNNDescriptor**.
- ▶ If **direction** is **CUDNN\_BIDIRECTIONAL** the first dimension should match double the **numLayers** argument passed to **cudaSetRNNDescriptor**.

The second dimension must match the first dimension of the tensors described in **xDesc**. The third dimension must match the **hiddenSize** argument passed to the **cudaSetRNNDescriptor** call used to initialize **rnnDesc**. The tensor must be fully packed.

**dhy**

*Input.* Data pointer to GPU memory associated with the tensor descriptor **dhyDesc**. If a NULL pointer is passed, the gradients at the final hidden state of the network will be initialized to zero.

**dcyDesc**

*Input.* A fully packed tensor descriptor describing the gradients at the final cell state of the RNN. The first dimension of the tensor depends on the **direction** argument passed to the **cudaSetRNNDescriptor** call used to initialize **rnnDesc**:

- ▶ If **direction** is **CUDNN\_UNIDIRECTIONAL** the first dimension should match the **numLayers** argument passed to **cudaSetRNNDescriptor**.
- ▶ If **direction** is **CUDNN\_BIDIRECTIONAL** the first dimension should match double the **numLayers** argument passed to **cudaSetRNNDescriptor**.

The second dimension must match the first dimension of the tensors described in **xDesc**. The third dimension must match the **hiddenSize** argument passed to the **cudaSetRNNDescriptor** call used to initialize **rnnDesc**. The tensor must be fully packed.

**dcy**

*Input.* Data pointer to GPU memory associated with the tensor descriptor **dcyDesc**. If a NULL pointer is passed, the gradients at the final cell state of the network will be initialized to zero.

**wDesc**

*Input.* Handle to a previously initialized filter descriptor describing the weights for the RNN. See [cudaFilterDescriptor\\_t](#).

**w**

*Input.* Data pointer to GPU memory associated with the filter descriptor **wDesc**.

**hxDesc**

*Input.* A fully packed tensor descriptor describing the initial hidden state of the RNN. The first dimension of the tensor depends on the **direction** argument passed to the **cudaSetRNNDescriptor** call used to initialize **rnnDesc**:

- ▶ If **direction** is **CUDNN\_UNIDIRECTIONAL** the first dimension should match the **numLayers** argument passed to **cudaSetRNNDescriptor**.
- ▶ If **direction** is **CUDNN\_BIDIRECTIONAL** the first dimension should match double the **numLayers** argument passed to **cudaSetRNNDescriptor**.

The second dimension must match the second dimension of the tensors described in **xDesc**. The third dimension must match the **hiddenSize** argument passed to the **cudaSetRNNDescriptor** call used to initialize **rnnDesc**. The tensor must be fully packed.

**hx**

*Input.* Data pointer to GPU memory associated with the tensor descriptor **hxDesc**. If a NULL pointer is passed, the initial hidden state of the network will be initialized to zero.

**cxDesc**

*Input.* A fully packed tensor descriptor describing the initial cell state for LSTM networks. The first dimension of the tensor depends on the **direction** argument passed to the **cudaSetRNNDescriptor** call used to initialize **rnnDesc**:

- ▶ If **direction** is **CUDNN\_UNIDIRECTIONAL** the first dimension should match the **numLayers** argument passed to **cudaSetRNNDescriptor**.
- ▶ If **direction** is **CUDNN\_BIDIRECTIONAL** the first dimension should match double the **numLayers** argument passed to **cudaSetRNNDescriptor**.

The second dimension must match the second dimension of the tensors described in **xDesc**. The third dimension must match the **hiddenSize** argument passed to the **cudaSetRNNDescriptor** call used to initialize **rnnDesc**. The tensor must be fully packed.

**cx**

*Input.* Data pointer to GPU memory associated with the tensor descriptor **cxDesc**. If a NULL pointer is passed, the initial cell state of the network will be initialized to zero.

**dxDesc**

*Input.* An array of fully packed tensor descriptors describing the gradient at the input of each recurrent iteration (one descriptor per iteration). The first dimension (batch size) of the tensors may decrease from element **n** to element **n+1** but may not increase. Each tensor descriptor must have the same second dimension (vector length).

**dx**

*Output.* Data pointer to GPU memory associated with the tensor descriptors in the array **dxDesc**.

**dhxDesc**

*Input.* A fully packed tensor descriptor describing the gradient at the initial hidden state of the RNN. The first dimension of the tensor depends on the **direction** argument passed to the **cudaSetRNNDescriptor** call used to initialize **rnnDesc**:

- ▶ If **direction** is **CUDNN\_UNIDIRECTIONAL** the first dimension should match the **numLayers** argument passed to **cudaSetRNNDescriptor**.
- ▶ If **direction** is **CUDNN\_BIDIRECTIONAL** the first dimension should match double the **numLayers** argument passed to **cudaSetRNNDescriptor**.

The second dimension must match the first dimension of the tensors described in **xDesc**. The third dimension must match the **hiddenSize** argument passed to the **cudaSetRNNDescriptor** call used to initialize **rnnDesc**. The tensor must be fully packed.

**dhx**

*Output.* Data pointer to GPU memory associated with the tensor descriptor **dhxDesc**. If a NULL pointer is passed, the gradient at the hidden input of the network will not be set.

**dcxDesc**

*Input.* A fully packed tensor descriptor describing the gradient at the initial cell state of the RNN. The first dimension of the tensor depends on the **direction** argument passed to the **cudaSetRNNDescriptor** call used to initialize **rnnDesc**:

- ▶ If **direction** is **CUDNN\_UNIDIRECTIONAL** the first dimension should match the **numLayers** argument passed to **cudaSetRNNDescriptor**.
- ▶ If **direction** is **CUDNN\_BIDIRECTIONAL** the first dimension should match double the **numLayers** argument passed to **cudaSetRNNDescriptor**.

The second dimension must match the first dimension of the tensors described in **xDesc**. The third dimension must match the **hiddenSize** argument passed to the **cudaSetRNNDescriptor** call used to initialize **rnnDesc**. The tensor must be fully packed.

**dcx**

*Output.* Data pointer to GPU memory associated with the tensor descriptor **dcxDesc**. If a NULL pointer is passed, the gradient at the cell input of the network will not be set.

**workspace**

*Input.* Data pointer to GPU memory to be used as a workspace for this call.

**workspaceSizeInBytes**

*Input.* Specifies the size in bytes of the provided **workspace**.

**reserveSpace**

*Input/Output.* Data pointer to GPU memory to be used as a reserve space for this call.

**reserveSpaceSizeInBytes**

*Input.* Specifies the size in bytes of the provided **reserveSpace**.

The possible error values returned by this function and their meanings are listed below.

### Returns

#### **CUDNN\_STATUS\_SUCCESS**

The function launched successfully.

#### **CUDNN\_STATUS\_NOT\_SUPPORTED**

The function does not support the provided configuration.

#### **CUDNN\_STATUS\_BAD\_PARAM**

At least one of the following conditions are met:

- ▶ The descriptor `rnnDesc` is invalid.
- ▶ At least one of the descriptors `dhxDesc`, `wDesc`, `hxDesc`, `cxDesc`, `dcxDesc`, `dhyDesc`, `dcyDesc` or one of the descriptors in `yDesc`, `dxDesc`, `dyDesc` is invalid.
- ▶ The descriptors in one of `yDesc`, `dxDesc`, `dyDesc`, `dhxDesc`, `wDesc`, `hxDesc`, `cxDesc`, `dcxDesc`, `dhyDesc`, `dcyDesc` has incorrect strides or dimensions.
- ▶ `workspaceSizeInBytes` is too small.
- ▶ `reserveSpaceSizeInBytes` is too small.

#### **CUDNN\_STATUS\_EXECUTION\_FAILED**

The function failed to launch on the GPU.

#### **CUDNN\_STATUS\_ALLOC\_FAILED**

The function was unable to allocate memory.

## 4.162. cudnnRNNBackwardDataEx

```

cudnnStatus_t cudnnRNNBackwardDataEx(
    cudnnHandle_t          handle,
    const cudnnRNNDescriptor_t  rnnDesc,
    const cudnnRNNDataDescriptor_t  yDesc,
    const void             *y,
    const cudnnRNNDataDescriptor_t  dyDesc,
    const void             *dy,
    const cudnnRNNDataDescriptor_t  dcDesc,
    const void             *dcAttn,
    const cudnnTensorDescriptor_t  dhyDesc,
    const void             *dhy,
    const cudnnTensorDescriptor_t  dcyDesc,
    const void             *dcy,
    const cudnnFilterDescriptor_t  wDesc,
    const void             *w,
    const cudnnTensorDescriptor_t  hxDesc,
    const void             *hx,
    const cudnnTensorDescriptor_t  cxDesc,
    const void             *cx,
    const cudnnRNNDataDescriptor_t  dxDesc,
    void             *dx,
    const cudnnTensorDescriptor_t  dhxDesc,
    void             *dhx,
    const cudnnTensorDescriptor_t  dcxDesc,

```

```

void          *dcx,
const cudnnRNNDataDescriptor_t dkDesc,
void          *dkeys,
void          *workSpace,
size_t        workSpaceSizeInBytes,
void          *reserveSpace,
size_t        reserveSpaceSizeInBytes)

```

This routine is the extended version of the function `cudaNNRNNBackwardData`. This function `cudaNNRNNBackwardDataEx` allows the user to use unpacked (padded) layout for input `y` and output `dx`.

In the unpacked layout, each sequence in the mini-batch is considered to be of fixed length, specified by `maxSeqLength` in its corresponding `RNNDataDescriptor`. Each fixed-length sequence, for example, the `n`th sequence in the mini-batch, is composed of a valid segment specified by the `seqLengthArray[n]` in its corresponding `RNNDataDescriptor`; and a padding segment to make the combined sequence length equal to `maxSeqLength`.

With the unpacked layout, both sequence major (i.e. time major) and batch major are supported. For backward compatibility, the packed sequence major layout is supported. However, similar to the non-extended function `cudaNNRNNBackwardData`, the sequences in the mini-batch need to be sorted in descending order according to length.

### Parameters

#### `handle`

*Input.* Handle to a previously created cuDNN context.

#### `rnnDesc`

*Input.* A previously initialized RNN descriptor.

#### `yDesc`

*Input.* A previously initialized RNN data descriptor. Must match or be the exact same descriptor previously passed into `cudaNNRNNForwardTrainingEx`.

#### `y`

*Input.* Data pointer to the GPU memory associated with the RNN data descriptor `yDesc`. The vectors are expected to be laid out in memory according to the layout specified by `yDesc`. The elements in the tensor (including elements in the padding vector) must be densely packed, and no strides are supported. Must contain the exact same data previously produced by `cudaNNRNNForwardTrainingEx`.

#### `dyDesc`

*Input.* A previously initialized RNN data descriptor. The `dataType`, `layout`, `maxSeqLength`, `batchSize`, `vectorSize` and `seqLengthArray` need to match the `yDesc` previously passed to `cudaNNRNNForwardTrainingEx`.

#### `dy`

*Input.* Data pointer to the GPU memory associated with the RNN data descriptor `dyDesc`. The vectors are expected to be laid out in memory according to the layout specified by `dyDesc`. The elements in the tensor (including elements in the padding vector) must be densely packed, and no strides are supported.

**dhyDesc**

*Input.* A fully packed tensor descriptor describing the gradients at the final hidden state of the RNN. The first dimension of the tensor depends on the **direction** argument passed to the **cudaSetRNNDesc** call used to initialize **rnnDesc**. Moreover:

- ▶ If **direction** is **CUDNN\_UNIDIRECTIONAL** the first dimension should match the **numLayers** argument passed to **cudaSetRNNDesc**.
- ▶ If **direction** is **CUDNN\_BIDIRECTIONAL** the first dimension should match double the **numLayers** argument passed to **cudaSetRNNDesc**.

The second dimension must match the **batchSize** parameter in **xDesc**.

The third dimension depends on whether RNN mode is **CUDNN\_LSTM** and whether LSTM projection is enabled. Moreover:

- ▶ If RNN mode is **CUDNN\_LSTM** and LSTM projection is enabled, the third dimension must match the **recProjSize** argument passed to **cudaSetRNNProjectionLayers** call used to set **rnnDesc**.
- ▶ Otherwise, the third dimension must match the **hiddenSize** argument passed to the **cudaSetRNNDesc** call used to initialize **rnnDesc**.

**dhy**

*Input.* Data pointer to GPU memory associated with the tensor descriptor **dhyDesc**. If a NULL pointer is passed, the gradients at the final hidden state of the network will be initialized to zero.

**dcyDesc**

*Input.* A fully packed tensor descriptor describing the gradients at the final cell state of the RNN. The first dimension of the tensor depends on the **direction** argument passed to the **cudaSetRNNDesc** call used to initialize **rnnDesc**. Moreover:

- ▶ If **direction** is **CUDNN\_UNIDIRECTIONAL** the first dimension should match the **numLayers** argument passed to **cudaSetRNNDesc**.
- ▶ If **direction** is **CUDNN\_BIDIRECTIONAL** the first dimension should match double the **numLayers** argument passed to **cudaSetRNNDesc**.

The second dimension must match the first dimension of the tensors described in **xDesc**.

The third dimension must match the **hiddenSize** argument passed to the **cudaSetRNNDesc** call used to initialize **rnnDesc**. The tensor must be fully packed.

**dcy**

*Input.* Data pointer to GPU memory associated with the tensor descriptor **dcyDesc**. If a NULL pointer is passed, the gradients at the final cell state of the network will be initialized to zero.

**wDesc**

*Input.* Handle to a previously initialized filter descriptor describing the weights for the RNN.

**w**

*Input.* Data pointer to GPU memory associated with the filter descriptor **wDesc**.

**hxDesc**

*Input.* A fully packed tensor descriptor describing the initial hidden state of the RNN. Must match or be the exact same descriptor previously passed into **cudaRNNForwardTrainingEx**.

**hx**

*Input.* Data pointer to GPU memory associated with the tensor descriptor **hxDesc**. If a NULL pointer is passed, the initial hidden state of the network will be initialized to zero. Must contain the exact same data previously passed into **cudaRNNForwardTrainingEx**, or be NULL if NULL was previously passed to **cudaRNNForwardTrainingEx**.

**cxDesc**

*Input.* A fully packed tensor descriptor describing the initial cell state for LSTM networks. Must match or be the exact same descriptor previously passed into **cudaRNNForwardTrainingEx**.

**cx**

*Input.* Data pointer to GPU memory associated with the tensor descriptor **cxDesc**. If a NULL pointer is passed, the initial cell state of the network will be initialized to zero. Must contain the exact same data previously passed into **cudaRNNForwardTrainingEx**, or be NULL if NULL was previously passed to **cudaRNNForwardTrainingEx**.

**dxDesc**

*Input.* A previously initialized RNN data descriptor. The **dataType**, **layout**, **maxSeqLength**, **batchSize**, **vectorSize** and **seqLengthArray** need to match that of **xDesc** previously passed to **cudaRNNForwardtrainingEx**.

**dx**

*Output.* Data pointer to the GPU memory associated with the RNN data descriptor **dxDesc**. The vectors are expected to be laid out in memory according to the layout specified by **dxDesc**. The elements in the tensor (including elements in the padding vector) must be densely packed, and no strides are supported.

**dhxDesc**

*Input.* A fully packed tensor descriptor describing the gradient at the initial hidden state of the RNN. The descriptor must be set exactly the same way as **dhyDesc**.

**dhx**

*Output.* Data pointer to GPU memory associated with the tensor descriptor **dhxDesc**. If a NULL pointer is passed, the gradient at the hidden input of the network will not be set.

**dcxDesc**

*Input.* A fully packed tensor descriptor describing the gradient at the initial cell state of the RNN. The descriptor must be set exactly the same way as **dcyDesc**.



**dcx**

*Output.* Data pointer to GPU memory associated with the tensor descriptor **dcxDesc**. If a NULL pointer is passed, the gradient at the cell input of the network will not be set.

**dkDesc**

Reserved. User may pass in NULL.

**dkeys**

Reserved. User may pass in NULL.

**workspace**

*Input.* Data pointer to GPU memory to be used as a workspace for this call.

**workspaceSizeInBytes**

*Input.* Specifies the size in bytes of the provided **workspace**.

**reserveSpace**

*Input/Output.* Data pointer to GPU memory to be used as a reserve space for this call.

**reserveSpaceSizeInBytes**

*Input.* Specifies the size in bytes of the provided **reserveSpace**.

**Returns****CUDNN\_STATUS\_SUCCESS**

The function launched successfully.

**CUDNN\_STATUS\_NOT\_SUPPORTED**

At least one of the following conditions are met:

- ▶ Variable sequence length input is passed in while **CUDNN\_RNN\_ALGO\_PERSIST\_STATIC** or **CUDNN\_RNN\_ALGO\_PERSIST\_DYNAMIC** is used.
- ▶ **CUDNN\_RNN\_ALGO\_PERSIST\_STATIC** or **CUDNN\_RNN\_ALGO\_PERSIST\_DYNAMIC** is used on pre-Pascal devices.
- ▶ Double input/output is used for **CUDNN\_RNN\_ALGO\_PERSIST\_STATIC**.

**CUDNN\_STATUS\_BAD\_PARAM**

At least one of the following conditions are met:

- ▶ The descriptor **rnnDesc** is invalid.
- ▶ At least one of the descriptors **yDesc**, **dxdesc**, **dydesc**, **dhxDesc**, **wDesc**, **hxDesc**, **cxDesc**, **dcxDesc**, **dhyDesc**, **dcyDesc** is invalid or has incorrect strides or dimensions.
- ▶ **workspaceSizeInBytes** is too small.
- ▶ **reserveSpaceSizeInBytes** is too small.

**CUDNN\_STATUS\_EXECUTION\_FAILED**

The function failed to launch on the GPU.

**CUDNN\_STATUS\_ALLOC\_FAILED**

The function was unable to allocate memory.

## 4.163. cudnnRNNBackwardWeights

```

cudnnStatus_t cudnnRNNBackwardWeights(
    cudnnHandle_t      handle,
    const cudnnRNNDescriptor_t  rnnDesc,
    const int          seqLength,
    const cudnnTensorDescriptor_t  *xDesc,
    const void         *x,
    const cudnnTensorDescriptor_t  hxDesc,
    const void         *hx,
    const cudnnTensorDescriptor_t  *yDesc,
    const void         *y,
    const void         *workspace,
    size_t             workspaceSizeInBytes,
    const cudnnFilterDescriptor_t  dwDesc,
    void              *dw,
    const void         *reserveSpace,
    size_t             reserveSpaceSizeInBytes)

```

This routine accumulates weight gradients **dw** from the recurrent neural network described by **rnnDesc** with inputs **x**, **hx**, and outputs **y**. The mode of operation in this case is additive, the weight gradients calculated will be added to those already existing in **dw**. **workspace** is required for intermediate storage. The data in **reserveSpace** must have previously been generated by **cudnnRNNBackwardData**.

### Parameters

#### handle

*Input.* Handle to a previously created cuDNN context.

#### rnnDesc

*Input.* A previously initialized RNN descriptor.

#### seqLength

*Input.* Number of iterations to unroll over. The value of this **seqLength** must not exceed the value that was used in **cudnnGetRNNWorkspaceSize()** function for querying the workspace size required to execute the RNN.

#### xDesc

*Input.* An array of fully packed tensor descriptors describing the input to each recurrent iteration (one descriptor per iteration). The first dimension (batch size) of the tensors may decrease from element **n** to element **n+1** but may not increase. Each tensor descriptor must have the same second dimension (vector length).

#### x

*Input.* Data pointer to GPU memory associated with the tensor descriptors in the array **xDesc**.

**hxDesc**

*Input.* A fully packed tensor descriptor describing the initial hidden state of the RNN. The first dimension of the tensor depends on the **direction** argument passed to the **cudaSetRNNDescriptor** call used to initialize **rnnDesc**:

- ▶ If **direction** is **CUDNN\_UNIDIRECTIONAL** the first dimension should match the **numLayers** argument passed to **cudaSetRNNDescriptor**.
- ▶ If **direction** is **CUDNN\_BIDIRECTIONAL** the first dimension should match double the **numLayers** argument passed to **cudaSetRNNDescriptor**.

The second dimension must match the first dimension of the tensors described in **xDesc**. The third dimension must match the **hiddenSize** argument passed to the **cudaSetRNNDescriptor** call used to initialize **rnnDesc**. The tensor must be fully packed.

**hx**

*Input.* Data pointer to GPU memory associated with the tensor descriptor **hxDesc**. If a NULL pointer is passed, the initial hidden state of the network will be initialized to zero.

**yDesc**

*Input.* An array of fully packed tensor descriptors describing the output from each recurrent iteration (one descriptor per iteration). The second dimension of the tensor depends on the **direction** argument passed to the **cudaSetRNNDescriptor** call used to initialize **rnnDesc**:

- ▶ If **direction** is **CUDNN\_UNIDIRECTIONAL** the second dimension should match the **hiddenSize** argument passed to **cudaSetRNNDescriptor**.
- ▶ If **direction** is **CUDNN\_BIDIRECTIONAL** the second dimension should match double the **hiddenSize** argument passed to **cudaSetRNNDescriptor**.

The first dimension of the tensor **n** must match the first dimension of the tensor **n** in **dyDesc**.

**y**

*Input.* Data pointer to GPU memory associated with the output tensor descriptor **yDesc**.

**workspace**

*Input.* Data pointer to GPU memory to be used as a workspace for this call.

**workspaceSizeInBytes**

*Input.* Specifies the size in bytes of the provided **workspace**.

**dwDesc**

*Input.* Handle to a previously initialized filter descriptor describing the gradients of the weights for the RNN.

**dw**

*Input/Output.* Data pointer to GPU memory associated with the filter descriptor **dwDesc**.

**reserveSpace**

*Input.* Data pointer to GPU memory to be used as a reserve space for this call.

**reserveSpaceSizeInBytes**

*Input.* Specifies the size in bytes of the provided **reserveSpace**

The possible error values returned by this function and their meanings are listed below.

**Returns****CUDNN\_STATUS\_SUCCESS**

The function launched successfully.

**CUDNN\_STATUS\_NOT\_SUPPORTED**

The function does not support the provided configuration.

**CUDNN\_STATUS\_BAD\_PARAM**

At least one of the following conditions are met:

- ▶ The descriptor **rnnDesc** is invalid.
- ▶ At least one of the descriptors **hxDesc**, **dwDesc** or one of the descriptors in **xDesc**, **yDesc** is invalid.
- ▶ The descriptors in one of **xDesc**, **hxDesc**, **yDesc**, **dwDesc** has incorrect strides or dimensions.
- ▶ **workSpaceSizeInBytes** is too small.
- ▶ **reserveSpaceSizeInBytes** is too small.

**CUDNN\_STATUS\_EXECUTION\_FAILED**

The function failed to launch on the GPU.

**CUDNN\_STATUS\_ALLOC\_FAILED**

The function was unable to allocate memory.

## 4.164. cudnnRNNBackwardWeightsEx

```

cudnnStatus_t cudnnRNNBackwardWeightsEx(
    cudnnHandle_t          handle,
    const cudnnRNNDescriptor_t  rnnDesc,
    const cudnnRNNDataDescriptor_t  xDesc,
    const void             *x,
    const cudnnTensorDescriptor_t  hxDesc,
    const void             *hx,
    const cudnnRNNDataDescriptor_t  yDesc,
    const void             *y,
    void                  *workSpace,
    size_t                workSpaceSizeInBytes,
    const cudnnFilterDescriptor_t  dwDesc,
    void                  *dw,
    void                  *reserveSpace,
    size_t                reserveSpaceSizeInBytes)

```

This routine is the extended version of the function `cudaRNNBackwardWeights`. This function `cudaRNNBackwardWeightsEx` allows the user to use unpacked (padded) layout for input `x` and output `dw`.

In the unpacked layout, each sequence in the mini-batch is considered to be of fixed length, specified by `maxSeqLength` in its corresponding `RNNDataDescriptor`. Each fixed-length sequence, for example, the `n`th sequence in the mini-batch, is composed of a valid segment specified by the `seqLengthArray[n]` in its corresponding `RNNDataDescriptor`; and a padding segment to make the combined sequence length equal to `maxSeqLength`.

With the unpacked layout, both sequence major (i.e. time major) and batch major are supported. For backward compatibility, the packed sequence major layout is supported. However, similar to the non-extended function `cudaRNNBackwardWeights`, the sequences in the mini-batch need to be sorted in descending order according to length.

## Parameters

### `handle`

*Input.* Handle to a previously created cuDNN context.

### `rnnDesc`

*Input.* A previously initialized RNN descriptor.

### `xDesc`

*Input.* A previously initialized RNN data descriptor. Must match or be the exact same descriptor previously passed into `cudaRNNForwardTrainingEx`.

### `x`

*Input.* Data pointer to GPU memory associated with the tensor descriptors in the array `xDesc`. Must contain the exact same data previously passed into `cudaRNNForwardTrainingEx`.

### `hxDesc`

*Input.* A fully packed tensor descriptor describing the initial hidden state of the RNN. Must match or be the exact same descriptor previously passed into `cudaRNNForwardTrainingEx`.

### `hx`

*Input.* Data pointer to GPU memory associated with the tensor descriptor `hxDesc`. If a NULL pointer is passed, the initial hidden state of the network will be initialized to zero. Must contain the exact same data previously passed into `cudaRNNForwardTrainingEx`, or be NULL if NULL was previously passed to `cudaRNNForwardTrainingEx`.

### `yDesc`

*Input.* A previously initialized RNN data descriptor. Must match or be the exact same descriptor previously passed into `cudaRNNForwardTrainingEx`.

**y**

*Input.* Data pointer to GPU memory associated with the output tensor descriptor **yDesc**. Must contain the exact same data previously produced by **cudaRNNForwardTrainingEx**.

**workspace**

*Input.* Data pointer to GPU memory to be used as a workspace for this call.

**workspaceSizeInBytes**

*Input.* Specifies the size in bytes of the provided **workspace**.

**dwDesc**

*Input.* Handle to a previously initialized filter descriptor describing the gradients of the weights for the RNN.

**dw**

*Input/Output.* Data pointer to GPU memory associated with the filter descriptor **dwDesc**.

**reserveSpace**

*Input.* Data pointer to GPU memory to be used as a reserve space for this call.

**reserveSpaceSizeInBytes**

*Input.* Specifies the size in bytes of the provided **reserveSpace**

**Returns****CUDNN\_STATUS\_SUCCESS**

The function launched successfully.

**CUDNN\_STATUS\_NOT\_SUPPORTED**

The function does not support the provided configuration.

**CUDNN\_STATUS\_BAD\_PARAM**

At least one of the following conditions are met:

- ▶ The descriptor **rnnDesc** is invalid.
- ▶ At least one of the descriptors **xDesc**, **yDesc**, **hxDesc**, **dwDesc** is invalid, or has incorrect strides or dimensions.
- ▶ **workspaceSizeInBytes** is too small.
- ▶ **reserveSpaceSizeInBytes** is too small.

**CUDNN\_STATUS\_EXECUTION\_FAILED**

The function failed to launch on the GPU.

**CUDNN\_STATUS\_ALLOC\_FAILED**

The function was unable to allocate memory.

## 4.165. cudnnRNNForwardInference

```

cudnnStatus_t cudnnRNNForwardInference (
    cudnnHandle_t          handle,
    const cudnnRNNDescriptor_t  rnnDesc,
    const int              seqLength,
    const cudnnTensorDescriptor_t *xDesc,
    const void             *x,
    const cudnnTensorDescriptor_t hxDesc,
    const void             *hx,
    const cudnnTensorDescriptor_t cxDesc,
    const void             *cx,
    const cudnnFilterDescriptor_t wDesc,
    const void             *w,
    const cudnnTensorDescriptor_t *yDesc,
    void                  *y,
    const cudnnTensorDescriptor_t hyDesc,
    void                  *hy,
    const cudnnTensorDescriptor_t cyDesc,
    void                  *cy,
    void                  *workspace,
    size_t                 workspaceSizeInBytes)

```

This routine executes the recurrent neural network described by **rnnDesc** with inputs **x**, **hx**, **cx**, weights **w** and outputs **y**, **hy**, **cy**. **workspace** is required for intermediate storage. This function does not store intermediate data required for training; **cudnnRNNForwardTraining** should be used for that purpose.

### Parameters

#### handle

*Input.* Handle to a previously created cuDNN context.

#### rnnDesc

*Input.* A previously initialized RNN descriptor.

#### seqLength

*Input.* Number of iterations to unroll over. The value of this **seqLength** must not exceed the value that was used in **cudnnGetRNNWorkspaceSize()** function for querying the workspace size required to execute the RNN.

#### xDesc

*Input.* An array of 'seqLength' fully packed tensor descriptors. Each descriptor in the array should have three dimensions that describe the input data format to one recurrent iteration (one descriptor per RNN time-step). The first dimension (batch size) of the tensors may decrease from iteration **n** to iteration **n+1** but may not increase. Each tensor descriptor must have the same second dimension (RNN input vector length, inputSize). The third dimension of each tensor should be 1. Input data are expected to be arranged in the column-major order so strides in **xDesc** should be set as follows: strideA[0]=inputSize, strideA[1]=1, strideA[2]=1.

#### x

*Input.* Data pointer to GPU memory associated with the array of tensor descriptors **xDesc**. The input vectors are expected to be packed contiguously with the first vector

of iteration (time-step)  $n+1$  following directly from the last vector of iteration  $n$ . In other words, input vectors for all RNN time-steps should be packed in the contiguous block of GPU memory with no gaps between the vectors.

### **hxDesc**

*Input.* A fully packed tensor descriptor describing the initial hidden state of the RNN. The first dimension of the tensor depends on the **direction** argument passed to the **cudaSetRNNDescriptor** call used to initialize **rnnDesc**:

- ▶ If **direction** is **CUDNN\_UNIDIRECTIONAL** the first dimension should match the **numLayers** argument passed to **cudaSetRNNDescriptor**.
- ▶ If **direction** is **CUDNN\_BIDIRECTIONAL** the first dimension should match double the **numLayers** argument passed to **cudaSetRNNDescriptor**.

The second dimension must match the first dimension of the tensors described in **xDesc**. The third dimension must match the **hiddenSize** argument passed to the **cudaSetRNNDescriptor** call used to initialize **rnnDesc**. The tensor must be fully packed.

### **hx**

*Input.* Data pointer to GPU memory associated with the tensor descriptor **hxDesc**. If a NULL pointer is passed, the initial hidden state of the network will be initialized to zero.

### **cxDesc**

*Input.* A fully packed tensor descriptor describing the initial cell state for LSTM networks. The first dimension of the tensor depends on the **direction** argument passed to the **cudaSetRNNDescriptor** call used to initialize **rnnDesc**:

- ▶ If **direction** is **CUDNN\_UNIDIRECTIONAL** the first dimension should match the **numLayers** argument passed to **cudaSetRNNDescriptor**.
- ▶ If **direction** is **CUDNN\_BIDIRECTIONAL** the first dimension should match double the **numLayers** argument passed to **cudaSetRNNDescriptor**.

The second dimension must match the first dimension of the tensors described in **xDesc**. The third dimension must match the **hiddenSize** argument passed to the **cudaSetRNNDescriptor** call used to initialize **rnnDesc**. The tensor must be fully packed.

### **cx**

*Input.* Data pointer to GPU memory associated with the tensor descriptor **cxDesc**. If a NULL pointer is passed, the initial cell state of the network will be initialized to zero.

### **wDesc**

*Input.* Handle to a previously initialized filter descriptor describing the weights for the RNN.

### **w**

*Input.* Data pointer to GPU memory associated with the filter descriptor **wDesc**.



**yDesc**

*Input.* An array of fully packed tensor descriptors describing the output from each recurrent iteration (one descriptor per iteration). The second dimension of the tensor depends on the **direction** argument passed to the **cudaSetRNNDescriptor** call used to initialize **rnnDesc**:

- ▶ If **direction** is **CUDNN\_UNIDIRECTIONAL** the second dimension should match the **hiddenSize** argument passed to **cudaSetRNNDescriptor**.
- ▶ If **direction** is **CUDNN\_BIDIRECTIONAL** the second dimension should match double the **hiddenSize** argument passed to **cudaSetRNNDescriptor**.

The first dimension of the tensor **n** must match the first dimension of the tensor **n** in **xDesc**.

**y**

*Output.* Data pointer to GPU memory associated with the output tensor descriptor **yDesc**. The data are expected to be packed contiguously with the first element of iteration **n+1** following directly from the last element of iteration **n**.

**hyDesc**

*Input.* A fully packed tensor descriptor describing the final hidden state of the RNN. The first dimension of the tensor depends on the **direction** argument passed to the **cudaSetRNNDescriptor** call used to initialize **rnnDesc**:

- ▶ If **direction** is **CUDNN\_UNIDIRECTIONAL** the first dimension should match the **numLayers** argument passed to **cudaSetRNNDescriptor**.
- ▶ If **direction** is **CUDNN\_BIDIRECTIONAL** the first dimension should match double the **numLayers** argument passed to **cudaSetRNNDescriptor**.

The second dimension must match the first dimension of the tensors described in **xDesc**. The third dimension must match the **hiddenSize** argument passed to the **cudaSetRNNDescriptor** call used to initialize **rnnDesc**. The tensor must be fully packed.

**hy**

*Output.* Data pointer to GPU memory associated with the tensor descriptor **hyDesc**. If a NULL pointer is passed, the final hidden state of the network will not be saved.

**cyDesc**

*Input.* A fully packed tensor descriptor describing the final cell state for LSTM networks. The first dimension of the tensor depends on the **direction** argument passed to the **cudaSetRNNDescriptor** call used to initialize **rnnDesc**:

- ▶ If **direction** is **CUDNN\_UNIDIRECTIONAL** the first dimension should match the **numLayers** argument passed to **cudaSetRNNDescriptor**.
- ▶ If **direction** is **CUDNN\_BIDIRECTIONAL** the first dimension should match double the **numLayers** argument passed to **cudaSetRNNDescriptor**.

The second dimension must match the first dimension of the tensors described in **xDesc**. The third dimension must match the **hiddenSize** argument passed to the **cudaSetRNNDescriptor** call used to initialize **rnnDesc**. The tensor must be fully packed.

**cy**

*Output.* Data pointer to GPU memory associated with the tensor descriptor **cyDesc**. If a NULL pointer is passed, the final cell state of the network will not be saved.

**workspace**

*Input.* Data pointer to GPU memory to be used as a workspace for this call.

**workspaceSizeInBytes**

*Input.* Specifies the size in bytes of the provided **workspace**.

The possible error values returned by this function and their meanings are listed below.

**Returns**

**CUDNN\_STATUS\_SUCCESS**

The function launched successfully.

**CUDNN\_STATUS\_NOT\_SUPPORTED**

The function does not support the provided configuration.

**CUDNN\_STATUS\_BAD\_PARAM**

At least one of the following conditions are met:

- ▶ The descriptor **rnnDesc** is invalid.
- ▶ At least one of the descriptors **hxDesc**, **cxDesc**, **wDesc**, **hyDesc**, **cyDesc** or one of the descriptors in **xDesc**, **yDesc** is invalid.
- ▶ The descriptors in one of **xDesc**, **hxDesc**, **cxDesc**, **wDesc**, **yDesc**, **hyDesc**, **cyDesc** have incorrect strides or dimensions.
- ▶ **workspaceSizeInBytes** is too small.

**CUDNN\_STATUS\_EXECUTION\_FAILED**

The function failed to launch on the GPU.

**CUDNN\_STATUS\_ALLOC\_FAILED**

The function was unable to allocate memory.

## 4.166. cudnnRNNForwardInferenceEx

```

cudnnStatus_t cudnnRNNForwardInferenceEx(
    cudnnHandle_t          handle,
    const cudnnRNNDescriptor_t  rnnDesc,
    const cudnnRNNDataDescriptor_t  xDesc,
    const void             *x,
    const cudnnTensorDescriptor_t  hxDesc,
    const void             *hx,
    const cudnnTensorDescriptor_t  cxDesc,
    const void             *cx,
    const cudnnFilterDescriptor_t  wDesc,
    const void             *w,
    const cudnnRNNDataDescriptor_t  yDesc,
    void                  *y,
    const cudnnTensorDescriptor_t  hyDesc,
    void                  *hy,

```

```

const cudnnTensorDescriptor_t  cyDesc,
void                            *cy,
const cudnnRNNDataDescriptor_t kDesc,
const void                      *keys,
const cudnnRNNDataDescriptor_t cDesc,
void                            *cAttn,
const cudnnRNNDataDescriptor_t iDesc,
void                            *iAttn,
const cudnnRNNDataDescriptor_t qDesc,
void                            *queries,
void                            *workSpace,
size_t                          workspaceSizeInBytes)

```

This routine is the extended version of the `cudnnRNNForwardInference` function. The `cudnnRNNForwardTrainingEx` allows the user to use unpacked (padded) layout for input **x** and output **y**. In the unpacked layout, each sequence in the mini-batch is considered to be of fixed length, specified by `maxSeqLength` in its corresponding `RNNDataDescriptor`. Each fixed-length sequence, for example, the *n*th sequence in the mini-batch, is composed of a valid segment, specified by the `seqLengthArray[n]` in its corresponding `RNNDataDescriptor`, and a padding segment to make the combined sequence length equal to `maxSeqLength`.

With unpacked layout, both sequence major (i.e. time major) and batch major are supported. For backward compatibility, the packed sequence major layout is supported. However, similar to the non-extended function `cudnnRNNForwardInference`, the sequences in the mini-batch need to be sorted in descending order according to length.

## Parameters

### handle

*Input.* Handle to a previously created cuDNN context.

### rnnDesc

*Input.* A previously initialized RNN descriptor.

### xDesc

*Input.* A previously initialized RNN Data descriptor. The `dataType`, `layout`, `maxSeqLength`, `batchSize`, and `seqLengthArray` need to match that of `yDesc`.

### x

*Input.* Data pointer to the GPU memory associated with the RNN data descriptor `xDesc`. The vectors are expected to be laid out in memory according to the layout specified by `xDesc`. The elements in the tensor (including elements in the padding vector) must be densely packed, and no strides are supported.

### hxDesc

*Input.* A fully packed tensor descriptor describing the initial hidden state of the RNN. The first dimension of the tensor depends on the `direction` argument passed to the `cudnnSetRNNDescriptor` call used to initialize `rnnDesc`:

- ▶ If `direction` is `CUDNN_UNIDIRECTIONAL` the first dimension should match the `numLayers` argument passed to `cudnnSetRNNDescriptor`.
- ▶ If `direction` is `CUDNN_BIDIRECTIONAL` the first dimension should match double the `numLayers` argument passed to `cudnnSetRNNDescriptor`.

The second dimension must match the `batchSize` parameter described in `xDesc`.

The third dimension depends on whether RNN mode is `CUDNN_LSTM` and whether LSTM projection is enabled. In specific:

- ▶ If RNN mode is `CUDNN_LSTM` and LSTM projection is enabled, the third dimension must match the `recProjSize` argument passed to `cudaSetRNNProjectionLayers` call used to set `rnnDesc`.
- ▶ Otherwise, the third dimension must match the `hiddenSize` argument passed to the `cudaSetRNNDescriptor` call used to initialize `rnnDesc`.

#### hx

*Input.* Data pointer to GPU memory associated with the tensor descriptor `hxDesc`. If a NULL pointer is passed, the initial hidden state of the network will be initialized to zero.

#### cxDesc

*Input.* A fully packed tensor descriptor describing the initial cell state for LSTM networks. The first dimension of the tensor depends on the `direction` argument passed to the `cudaSetRNNDescriptor` call used to initialize `rnnDesc`:

- ▶ If `direction` is `CUDNN_UNIDIRECTIONAL` the first dimension should match the `numLayers` argument passed to `cudaSetRNNDescriptor`.
- ▶ If `direction` is `CUDNN_BIDIRECTIONAL` the first dimension should match double the `numLayers` argument passed to `cudaSetRNNDescriptor`.

The second dimension must match the `batchSize` parameter in `xDesc`. The third dimension must match the `hiddenSize` argument passed to the `cudaSetRNNDescriptor` call used to initialize `rnnDesc`.

#### cx

*Input.* Data pointer to GPU memory associated with the tensor descriptor `cxDesc`. If a NULL pointer is passed, the initial cell state of the network will be initialized to zero.

#### wDesc

*Input.* Handle to a previously initialized filter descriptor describing the weights for the RNN.

#### w

*Input.* Data pointer to GPU memory associated with the filter descriptor `wDesc`.

#### yDesc

*Input.* A previously initialized RNN data descriptor. The `dataType`, `layout`, `maxSeqLength`, `batchSize`, and `seqLengthArray` must match that of `dyDesc` and `dxDesc`. The parameter `vectorSize` depends on whether RNN mode is `CUDNN_LSTM` and whether LSTM projection is enabled and whether the network is bidirectional. In specific:

- ▶ For uni-directional network, if RNN mode is `CUDNN_LSTM` and LSTM projection is enabled, the parameter `vectorSize` must match the `recProjSize` argument passed to `cudaSetRNNProjectionLayers` call used to set `rnnDesc`. If the network is bidirectional, then multiply the value by 2.

- ▶ Otherwise, for uni-directional network, the parameter **vectorSize** must match the **hiddenSize** argument passed to the **cudaSetRNNDescriptor** call used to initialize **rnnDesc**. If the network is bidirectional, then multiply the value by 2.

**y**

*Output.* Data pointer to the GPU memory associated with the RNN data descriptor **yDesc**. The vectors are expected to be laid out in memory according to the layout specified by **yDesc**. The elements in the tensor (including elements in the padding vector) must be densely packed, and no strides are supported.

**hyDesc**

*Input.* A fully packed tensor descriptor describing the final hidden state of the RNN. The descriptor must be set exactly the same way as **hxDesc**.

**hy**

*Output.* Data pointer to GPU memory associated with the tensor descriptor **hyDesc**. If a NULL pointer is passed, the final hidden state of the network will not be saved.

**cyDesc**

*Input.* A fully packed tensor descriptor describing the final cell state for LSTM networks. The descriptor must be set exactly the same way as **cxDesc**.

**cy**

*Output.* Data pointer to GPU memory associated with the tensor descriptor **cyDesc**. If a NULL pointer is passed, the final cell state of the network will not be saved.

**kDesc**

Reserved. User may pass in NULL.

**Keys**

Reserved. User may pass in NULL.

**cDesc**

Reserved. User may pass in NULL.

**cAttn**

Reserved. User may pass in NULL.

**iDesc**

Reserved. User may pass in NULL.

**iAttn**

Reserved. User may pass in NULL.

**qDesc**

Reserved. User may pass in NULL.

**Queries**

Reserved. User may pass in NULL.

**workspace**

*Input.* Data pointer to GPU memory to be used as a workspace for this call.

**workspaceSizeInBytes**

*Input.* Specifies the size in bytes of the provided **workspace**.

**Returns****CUDNN\_STATUS\_SUCCESS**

The function launched successfully.

**CUDNN\_STATUS\_NOT\_SUPPORTED**

At least one of the following conditions are met:

- ▶ Variable sequence length input is passed in while **CUDNN\_RNN\_ALGO\_PERSIST\_STATIC** or **CUDNN\_RNN\_ALGO\_PERSIST\_DYNAMIC** is used.
- ▶ **CUDNN\_RNN\_ALGO\_PERSIST\_STATIC** or **CUDNN\_RNN\_ALGO\_PERSIST\_DYNAMIC** is used on pre-Pascal devices.
- ▶ Double input/output is used for **CUDNN\_RNN\_ALGO\_PERSIST\_STATIC**.

**CUDNN\_STATUS\_BAD\_PARAM**

At least one of the following conditions are met:

- ▶ The descriptor **rnnDesc** is invalid.
- ▶ At least one of the descriptors in **xDesc**, **yDesc**, **hxDesc**, **cxDesc**, **wDesc**, **hyDesc**, **cyDesc** is invalid, or have incorrect strides or dimensions.
- ▶ **reserveSpaceSizeInBytes** is too small.
- ▶ **workspaceSizeInBytes** is too small.

**CUDNN\_STATUS\_EXECUTION\_FAILED**

The function failed to launch on the GPU.

**CUDNN\_STATUS\_ALLOC\_FAILED**

The function was unable to allocate memory.

## 4.167. cudnnRNNForwardTraining

```

cudnnStatus_t cudnnRNNForwardTraining(
    cudnnHandle_t          handle,
    const cudnnRNNDescriptor_t  rnnDesc,
    const int              seqLength,
    const cudnnTensorDescriptor_t *xDesc,
    const void             *x,
    const cudnnTensorDescriptor_t  hxDesc,
    const void             *hx,
    const cudnnTensorDescriptor_t  cxDesc,
    const void             *cx,
    const cudnnFilterDescriptor_t  wDesc,
    const void             *w,
    const cudnnTensorDescriptor_t *yDesc,
    void                  *y,
    const cudnnTensorDescriptor_t  hyDesc,
    void                  *hy,
    const cudnnTensorDescriptor_t  cyDesc,
    void                  *cy,
    void                  *workspace,

```

```

size_t      workspaceSizeInBytes,
void        *reserveSpace,
size_t      reserveSpaceSizeInBytes)

```

This routine executes the recurrent neural network described by **rnnDesc** with inputs **x**, **hx**, **cx**, weights **w** and outputs **y**, **hy**, **cy**. **workspace** is required for intermediate storage. **reserveSpace** stores data required for training. The same **reserveSpace** data must be used for future calls to **cudaRNNBackwardData** and **cudaRNNBackwardWeights** if these execute on the same input data.

## Parameters

### handle

*Input.* Handle to a previously created cuDNN context.

### rnnDesc

*Input.* A previously initialized RNN descriptor.

### seqLength

*Input.* Number of iterations to unroll over. The value of this **seqLength** must not exceed the value that was used in **cudaGetRNNWorkspaceSize()** function for querying the workspace size required to execute the RNN.

### xDesc

*Input.* An array of 'seqLength' fully packed tensor descriptors. Each descriptor in the array should have three dimensions that describe the input data format to one recurrent iteration (one descriptor per RNN time-step). The first dimension (batch size) of the tensors may decrease from iteration element **n** to iteration element **n+1** but may not increase. Each tensor descriptor must have the same second dimension (RNN input vector length, **inputSize**). The third dimension of each tensor should be 1. Input vectors are expected to be arranged in the column-major order so strides in **xDesc** should be set as follows: **strideA[0]=inputSize**, **strideA[1]=1**, **strideA[2]=1**.

### x

*Input.* Data pointer to GPU memory associated with the array of tensor descriptors **xDesc**. The input vectors are expected to be packed contiguously with the first vector of iteration (time-step) **n+1** following directly the last vector of iteration **n**. In other words, input vectors for all RNN time-steps should be packed in the contiguous block of GPU memory with no gaps between the vectors.

### hxDesc

*Input.* A fully packed tensor descriptor describing the initial hidden state of the RNN. The first dimension of the tensor depends on the **direction** argument passed to the **cudaSetRNNDesc** call used to initialize **rnnDesc**:

- ▶ If **direction** is **CUDNN\_UNIDIRECTIONAL** the first dimension should match the **numLayers** argument passed to **cudaSetRNNDesc**.
- ▶ If **direction** is **CUDNN\_BIDIRECTIONAL** the first dimension should match double the **numLayers** argument passed to **cudaSetRNNDesc**.

The second dimension must match the first dimension of the tensors described in **xDesc**. The third dimension must match the **hiddenSize** argument passed to the

**cudaSetRNNDescriptor** call used to initialize **rnnDesc**. The tensor must be fully packed.

#### **hx**

*Input.* Data pointer to GPU memory associated with the tensor descriptor **hxDesc**. If a NULL pointer is passed, the initial hidden state of the network will be initialized to zero.

#### **cxDesc**

*Input.* A fully packed tensor descriptor describing the initial cell state for LSTM networks. The first dimension of the tensor depends on the **direction** argument passed to the **cudaSetRNNDescriptor** call used to initialize **rnnDesc**:

- ▶ If **direction** is **CUDNN\_UNIDIRECTIONAL** the first dimension should match the **numLayers** argument passed to **cudaSetRNNDescriptor**.
- ▶ If **direction** is **CUDNN\_BIDIRECTIONAL** the first dimension should match double the **numLayers** argument passed to **cudaSetRNNDescriptor**.

The second dimension must match the first dimension of the tensors described in **xDesc**. The third dimension must match the **hiddenSize** argument passed to the **cudaSetRNNDescriptor** call used to initialize **rnnDesc**. The tensor must be fully packed.

#### **cx**

*Input.* Data pointer to GPU memory associated with the tensor descriptor **cxDesc**. If a NULL pointer is passed, the initial cell state of the network will be initialized to zero.

#### **wDesc**

*Input.* Handle to a previously initialized filter descriptor describing the weights for the RNN.

#### **w**

*Input.* Data pointer to GPU memory associated with the filter descriptor **wDesc**.

#### **yDesc**

*Input.* An array of fully packed tensor descriptors describing the output from each recurrent iteration (one descriptor per iteration). The second dimension of the tensor depends on the **direction** argument passed to the **cudaSetRNNDescriptor** call used to initialize **rnnDesc**:

- ▶ If **direction** is **CUDNN\_UNIDIRECTIONAL** the second dimension should match the **hiddenSize** argument passed to **cudaSetRNNDescriptor**.
- ▶ If **direction** is **CUDNN\_BIDIRECTIONAL** the second dimension should match double the **hiddenSize** argument passed to **cudaSetRNNDescriptor**.

The first dimension of the tensor **n** must match the first dimension of the tensor **n** in **xDesc**.

#### **y**

*Output.* Data pointer to GPU memory associated with the output tensor descriptor **yDesc**.



**hyDesc**

*Input.* A fully packed tensor descriptor describing the final hidden state of the RNN. The first dimension of the tensor depends on the **direction** argument passed to the **cudaSetRNNDescriptor** call used to initialize **rnnDesc**:

- ▶ If **direction** is **CUDNN\_UNIDIRECTIONAL** the first dimension should match the **numLayers** argument passed to **cudaSetRNNDescriptor**.
- ▶ If **direction** is **CUDNN\_BIDIRECTIONAL** the first dimension should match double the **numLayers** argument passed to **cudaSetRNNDescriptor**.

The second dimension must match the first dimension of the tensors described in **xDesc**. The third dimension must match the **hiddenSize** argument passed to the **cudaSetRNNDescriptor** call used to initialize **rnnDesc**. The tensor must be fully packed.

**hy**

*Output.* Data pointer to GPU memory associated with the tensor descriptor **hyDesc**. If a NULL pointer is passed, the final hidden state of the network will not be saved.

**cyDesc**

*Input.* A fully packed tensor descriptor describing the final cell state for LSTM networks. The first dimension of the tensor depends on the **direction** argument passed to the **cudaSetRNNDescriptor** call used to initialize **rnnDesc**:

- ▶ If **direction** is **CUDNN\_UNIDIRECTIONAL** the first dimension should match the **numLayers** argument passed to **cudaSetRNNDescriptor**.
- ▶ If **direction** is **CUDNN\_BIDIRECTIONAL** the first dimension should match double the **numLayers** argument passed to **cudaSetRNNDescriptor**.

The second dimension must match the first dimension of the tensors described in **xDesc**. The third dimension must match the **hiddenSize** argument passed to the **cudaSetRNNDescriptor** call used to initialize **rnnDesc**. The tensor must be fully packed.

**cy**

*Output.* Data pointer to GPU memory associated with the tensor descriptor **cyDesc**. If a NULL pointer is passed, the final cell state of the network will be not be saved.

**workspace**

*Input.* Data pointer to GPU memory to be used as a workspace for this call.

**workspaceSizeInBytes**

*Input.* Specifies the size in bytes of the provided **workspace**.

**reserveSpace**

*Input/Output.* Data pointer to GPU memory to be used as a reserve space for this call.

**reserveSpaceSizeInBytes**

*Input.* Specifies the size in bytes of the provided **reserveSpace**

The possible error values returned by this function and their meanings are listed below.

**Returns**

**CUDNN\_STATUS\_SUCCESS**

The function launched successfully.

**CUDNN\_STATUS\_BAD\_PARAM**

At least one of the following conditions are met:

- ▶ The descriptor **rnnDesc** is invalid.
- ▶ At least one of the descriptors **hxDesc**, **cxDesc**, **wDesc**, **hyDesc**, **cyDesc** or one of the descriptors in **xDesc**, **yDesc** is invalid.
- ▶ The descriptors in one of **xDesc**, **hxDesc**, **cxDesc**, **wDesc**, **yDesc**, **hyDesc**, **cyDesc** have incorrect strides or dimensions.
- ▶ **workSpaceSizeInBytes** is too small.
- ▶ **reserveSpaceSizeInBytes** is too small.

**CUDNN\_STATUS\_EXECUTION\_FAILED**

The function failed to launch on the GPU.

**CUDNN\_STATUS\_ALLOC\_FAILED**

The function was unable to allocate memory.

## 4.168. cudnnRNNForwardTrainingEx

```

cudnnStatus_t cudnnRNNForwardTrainingEx(
    cudnnHandle_t             handle,
    const cudnnRNNDescriptor_t rnnDesc,
    const cudnnRNNDataDescriptor_t xDesc,
    const void                *x,
    const cudnnTensorDescriptor_t hxDesc,
    const void                *hx,
    const cudnnTensorDescriptor_t cxDesc,
    const void                *cx,
    const cudnnFilterDescriptor_t wDesc,
    const void                *w,
    const cudnnRNNDataDescriptor_t yDesc,
    void                      *y,
    const cudnnTensorDescriptor_t hyDesc,
    void                      *hy,
    const cudnnTensorDescriptor_t cyDesc,
    void                      *cy,
    const cudnnRNNDataDescriptor_t kDesc,
    const void                *keys,
    const cudnnRNNDataDescriptor_t cDesc,
    void                      *cAttn,
    const cudnnRNNDataDescriptor_t iDesc,
    void                      *iAttn,
    const cudnnRNNDataDescriptor_t qDesc,
    void                      *queries,
    void                      *workSpace,
    size_t                    workSpaceSizeInBytes,
    void                      *reserveSpace,
    size_t                    reserveSpaceSizeInBytes);

```

This routine is the extended version of the **cudnnRNNForwardTraining** function. The **cudnnRNNForwardTrainingEx** allows the user to use unpacked (padded) layout for input **x** and output **y**.

In the unpacked layout, each sequence in the mini-batch is considered to be of fixed length, specified by **maxSeqLength** in its corresponding **RNNDataDescriptor**. Each fixed-length sequence, for example, the **n**th sequence in the mini-batch, is composed of a valid segment specified by the **seqLengthArray[n]** in its corresponding **RNNDataDescriptor**; and a padding segment to make the combined sequence length equal to **maxSeqLength**.

With the unpacked layout, both sequence major (i.e. time major) and batch major are supported. For backward compatibility, the packed sequence major layout is supported. However, similar to the non-extended function **cudaRNNForwardTraining**, the sequences in the mini-batch need to be sorted in descending order according to length.

## Parameters

### handle

*Input.* Handle to a previously created cuDNN context.

### rnnDesc

*Input.* A previously initialized RNN descriptor.

### xDesc

*Input.* A previously initialized RNN Data descriptor. The **dataType**, **layout**, **maxSeqLength**, **batchSize**, and **seqLengthArray** need to match that of **yDesc**.

### x

*Input.* Data pointer to the GPU memory associated with the RNN data descriptor **xDesc**. The input vectors are expected to be laid out in memory according to the layout specified by **xDesc**. The elements in the tensor (including elements in the padding vector) must be densely packed, and no strides are supported.

### hxDesc

*Input.* A fully packed tensor descriptor describing the initial hidden state of the RNN.

The first dimension of the tensor depends on the **direction** argument passed to the **cudaSetRNNDescriptor** call used to initialize **rnnDesc**. Moreover:

- ▶ If **direction** is **CUDNN\_UNIDIRECTIONAL** then the first dimension should match the **numLayers** argument passed to **cudaSetRNNDescriptor**.
- ▶ If **direction** is **CUDNN\_BIDIRECTIONAL** then the first dimension should match double the **numLayers** argument passed to **cudaSetRNNDescriptor**.

The second dimension must match the **batchSize** parameter in **xDesc**.

The third dimension depends on whether RNN mode is **CUDNN\_LSTM** and whether **LSTM** projection is enabled. Moreover:

- ▶ If RNN mode is **CUDNN\_LSTM** and **LSTM** projection is enabled, the third dimension must match the **recProjSize** argument passed to **cudaSetRNNProjectionLayers** call used to set **rnnDesc**.
- ▶ Otherwise, the third dimension must match the **hiddenSize** argument passed to the **cudaSetRNNDescriptor** call used to initialize **rnnDesc**.

**hx**

*Input.* Data pointer to GPU memory associated with the tensor descriptor **hxDesc**. If a NULL pointer is passed, the initial hidden state of the network will be initialized to zero.

**cxDesc**

*Input.* A fully packed tensor descriptor describing the initial cell state for LSTM networks.

The first dimension of the tensor depends on the **direction** argument passed to the **cudaSetRNNDescriptor** call used to initialize **rnnDesc**. Moreover:

- ▶ If **direction** is **CUDNN\_UNIDIRECTIONAL** the first dimension should match the **numLayers** argument passed to **cudaSetRNNDescriptor**.
- ▶ If **direction** is **CUDNN\_BIDIRECTIONAL** the first dimension should match double the **numLayers** argument passed to **cudaSetRNNDescriptor**.

The second dimension must match the first dimension of the tensors described in **xDesc**.

The third dimension must match the **hiddenSize** argument passed to the **cudaSetRNNDescriptor** call used to initialize **rnnDesc**. The tensor must be fully packed.

**cx**

*Input.* Data pointer to GPU memory associated with the tensor descriptor **cxDesc**. If a NULL pointer is passed, the initial cell state of the network will be initialized to zero.

**wDesc**

*Input.* Handle to a previously initialized filter descriptor describing the weights for the RNN.

**w**

*Input.* Data pointer to GPU memory associated with the filter descriptor **wDesc**.

**yDesc**

*Input.* A previously initialized RNN data descriptor. The **dataType**, **layout**, **maxSeqLength**, **batchSize**, and **seqLengthArray** need to match that of **dyDesc** and **dxDesc**. The parameter **vectorSize** depends on whether RNN mode is **CUDNN\_LSTM** and whether LSTM projection is enabled and whether the network is bidirectional. In specific:

- ▶ For uni-directional network, if RNN mode is **CUDNN\_LSTM** and LSTM projection is enabled, the parameter **vectorSize** must match the **recProjSize** argument passed to **cudaSetRNNProjectionLayers** call used to set **rnnDesc**. If the network is bidirectional, then multiply the value by 2.
- ▶ Otherwise, for uni-directional network, the parameter **vectorSize** must match the **hiddenSize** argument passed to the **cudaSetRNNDescriptor** call used to initialize **rnnDesc**. If the network is bidirectional, then multiply the value by 2.

**y**

*Output.* Data pointer to GPU memory associated with the RNN data descriptor **yDesc**. The input vectors are expected to be laid out in memory according to the layout specified by **yDesc**. The elements in the tensor (including elements in the padding vector) must be densely packed, and no strides are supported.

**hyDesc**

*Input.* A fully packed tensor descriptor describing the final hidden state of the RNN. The descriptor must be set exactly the same as **hxDesc**.

**hy**

*Output.* Data pointer to GPU memory associated with the tensor descriptor **hyDesc**. If a NULL pointer is passed, the final hidden state of the network will not be saved.

**cyDesc**

*Input.* A fully packed tensor descriptor describing the final cell state for LSTM networks. The descriptor must be set exactly the same as **cxDesc**.

**cy**

*Output.* Data pointer to GPU memory associated with the tensor descriptor **cyDesc**. If a NULL pointer is passed, the final cell state of the network will be not be saved.

**kDesc**

Reserved. User may pass in NULL.

**Keys**

Reserved. User may pass in NULL.

**cDesc**

Reserved. User may pass in NULL.

**cAttn**

Reserved. User may pass in NULL.

**iDesc**

Reserved. User may pass in NULL.

**iAttn**

Reserved. User may pass in NULL.

**qDesc**

Reserved. User may pass in NULL.

**Queries**

Reserved. User may pass in NULL.

**workspace**

*Input.* Data pointer to GPU memory to be used as a workspace for this call.

**workspaceSizeInBytes**

*Input.* Specifies the size in bytes of the provided **workspace**.

**reserveSpace**

*Input/Output.* Data pointer to GPU memory to be used as a reserve space for this call.

**reserveSpaceSizeInBytes**

*Input.* Specifies the size in bytes of the provided **reserveSpace**

**Returns****CUDNN\_STATUS\_SUCCESS**

The function launched successfully.

**CUDNN\_STATUS\_NOT\_SUPPORTED**

At least one of the following conditions are met:

- ▶ Variable sequence length input is passed in while **CUDNN\_RNN\_ALGO\_PERSIST\_STATIC** or **CUDNN\_RNN\_ALGO\_PERSIST\_DYNAMIC** is used.
- ▶ **CUDNN\_RNN\_ALGO\_PERSIST\_STATIC** or **CUDNN\_RNN\_ALGO\_PERSIST\_DYNAMIC** is used on pre-Pascal devices.
- ▶ Double input/output is used for **CUDNN\_RNN\_ALGO\_PERSIST\_STATIC**.

**CUDNN\_STATUS\_BAD\_PARAM**

At least one of the following conditions are met:

- ▶ The descriptor **rnnDesc** is invalid.
- ▶ At least one of the descriptors **xDesc**, **yDesc**, **hxDesc**, **cxDesc**, **wDesc**, **hyDesc**, **cyDesc** is invalid, or have incorrect strides or dimensions.
- ▶ **workSpaceSizeInBytes** is too small.
- ▶ **reserveSpaceSizeInBytes** is too small.

**CUDNN\_STATUS\_EXECUTION\_FAILED**

The function failed to launch on the GPU.

**CUDNN\_STATUS\_ALLOC\_FAILED**

The function was unable to allocate memory.

## 4.169. cudnnRNNGetClip

```

cudnnStatus_t cudnnRNNGetClip(
    cudnnHandle_t          handle,
    cudnnRNNDescriptor_t  rnnDesc,
    cudnnRNNClipMode_t    *clipMode,
    cudnnNanPropagation_t *clipNanOpt,
    double                 *lclip,
    double                 *rclip);

```

Retrieves the current LSTM cell clipping parameters, and stores them in the arguments provided.

**Parameters**

**\*clipMode**

*Output.* Pointer to the location where the retrieved **clipMode** is stored. The **clipMode** can be CUDNN\_RNN\_CLIP\_NONE in which case no LSTM cell state clipping is being performed; or CUDNN\_RNN\_CLIP\_MINMAX, in which case the cell state activation to other units are being clipped.

**\*lclip, \*rclip**

*Output.* Pointers to the location where the retrieved LSTM cell clipping range [lclip, rclip] is stored.

**\*clipNanOpt**

*Output.* Pointer to the location where the retrieved **clipNanOpt** is stored.

**Returns****CUDNN\_STATUS\_SUCCESS**

The function launched successfully.

**CUDNN\_STATUS\_BAD\_PARAM**

If any of the pointer arguments provided are NULL.

## 4.170. cudnnRNNSetClip

```

cudnnStatus_t cudnnRNNSetClip(
    cudnnHandle_t          handle,
    cudnnRNNDescriptor_t   rnnDesc,
    cudnnRNNClipMode_t     clipMode,
    cudnnNanPropagation_t  clipNanOpt,
    double                 lclip,
    double                 rclip);

```

Sets the LSTM cell clipping mode. The LSTM clipping is disabled by default. When enabled, clipping is applied to all layers. This **cudnnRNNSetClip()** function may be called multiple times.

**Parameters****clipMode**

*Input.* Enables or disables the LSTM cell clipping. When **clipMode** is set to CUDNN\_RNN\_CLIP\_NONE no LSTM cell state clipping is performed. When **clipMode** is CUDNN\_RNN\_CLIP\_MINMAX the cell state activation to other units are clipped.

**lclip, rclip**

*Input.* The range [lclip, rclip] to which the LSTM cell clipping should be set.

**clipNanOpt**

*Input.* When set to CUDNN\_PROPAGATE\_NAN (See the description for **cudnnNanPropagation\_t**), NaN is propagated from the LSTM cell, or it can be set to one of the clipping range boundary values, instead of propagating.

**Returns**

**CUDNN\_STATUS\_SUCCESS**

The function launched successfully.

**CUDNN\_STATUS\_BAD\_PARAM**

Returns this value if `lclip > rclip`; or if either `lclip` or `rclip` is NaN.

## 4.171. cudnnSaveAlgorithm

```

cudnnStatus_t cudnnSaveAlgorithm(
    cudnnHandle_t      handle,
    cudnnAlgorithmDescriptor_t algoDesc,
    void*              algoSpace
    size_t             algoSpaceSizeInBytes)

```

(New for 7.1)

This function writes algorithm metadata into the host memory space provided by the user in `algoSpace`, allowing the user to preserve the results of RNN finds after cuDNN exits.

### Parameters

#### handle

*Input.* Handle to a previously created cuDNN context.

#### algoDesc

*Input.* A previously created algorithm descriptor.

#### algoSpace

*Input.* Pointer to the host memory to be written.

#### algoSpaceSizeInBytes

*Input.* Amount of host memory needed as workspace to be able to save the metadata from the specified `algoDesc`.

### Returns

**CUDNN\_STATUS\_SUCCESS**

The function launched successfully.

**CUDNN\_STATUS\_BAD\_PARAM**

At least one of the following conditions is met:

- ▶ One of the arguments is null.
- ▶ `algoSpaceSizeInBytes` is too small.

## 4.172. cudnnScaleTensor

```

cudnnStatus_t cudnnScaleTensor(
    cudnnHandle_t      handle,
    const cudnnTensorDescriptor_t yDesc,
    void*              *y,
    const void*        *alpha)

```



This function scale all the elements of a tensor by a given factor.

### Parameters

#### handle

*Input.* Handle to a previously created cuDNN context.

#### yDesc

*Input.* Handle to a previously initialized tensor descriptor.

#### y

*Input/Output.* Pointer to data of the tensor described by the **yDesc** descriptor.

#### alpha

*Input.* Pointer in Host memory to a single value that all elements of the tensor will be scaled with. [Please refer to this section for additional details.](#)

The possible error values returned by this function and their meanings are listed below.

### Returns

#### CUDNN\_STATUS\_SUCCESS

The function launched successfully.

#### CUDNN\_STATUS\_NOT\_SUPPORTED

The function does not support the provided configuration.

#### CUDNN\_STATUS\_BAD\_PARAM

one of the provided pointers is nil

#### CUDNN\_STATUS\_EXECUTION\_FAILED

The function failed to launch on the GPU.

## 4.173. cudnnSetActivationDescriptor

```

cudnnStatus_t cudnnSetActivationDescriptor(
    cudnnActivationDescriptor_t    activationDesc,
    cudnnActivationMode_t         mode,
    cudnnNanPropagation_t         reluNanOpt,
    double                         coef)

```

This function initializes a previously created generic activation descriptor object.

### Parameters

#### activationDesc

*Input/Output.* Handle to a previously created pooling descriptor.

#### mode

*Input.* Enumerant to specify the activation mode.

#### reluNanOpt

*Input.* Enumerant to specify the **Nan** propagation mode.

**coef**

*Input.* floating point number to specify the clipping threshold when the activation mode is set to `CUDNN_ACTIVATION_CLIPPED_RELU` or to specify the alpha coefficient when the activation mode is set to `CUDNN_ACTIVATION_RELU`.

The possible error values returned by this function and their meanings are listed below.

**Returns****CUDNN\_STATUS\_SUCCESS**

The object was set successfully.

**CUDNN\_STATUS\_BAD\_PARAM**

`mode` or `reluNanOpt` has an invalid enumerant value.

## 4.174. cudnnSetAlgorithmDescriptor

```

cudnnStatus_t cudnnSetAlgorithmDescriptor(
    cudnnAlgorithmDescriptor_t  algorithmDesc,
    cudnnAlgorithm_t           algorithm)

```

**(New for 7.1)**

This function initializes a previously created generic algorithm descriptor object.

**Parameters****algorithmDesc**

*Input/Output.* Handle to a previously created algorithm descriptor.

**algorithm**

*Input.* Struct to specify the algorithm.

**Returns****CUDNN\_STATUS\_SUCCESS**

The object was set successfully.

## 4.175. cudnnSetAlgorithmPerformance

```

cudnnStatus_t cudnnSetAlgorithmPerformance(
    cudnnAlgorithmPerformance_t  algoPerf,
    cudnnAlgorithmDescriptor_t   algoDesc,
    cudnnStatus_t               status,
    float                        time,
    size_t                       memory)

```

**(New for 7.1)**

This function initializes a previously created generic algorithm performance object.

**Parameters**

**algoPerf**

*Input/Output.* Handle to a previously created algorithm performance object.

**algoDesc**

*Input.* The algorithm descriptor which the performance results describe.

**status**

*Input.* The cudnn status returned from running the algoDesc algorithm.

**time**

*Input.* The GPU time spent running the algoDesc algorithm.

**memory**

*Input.* The GPU memory needed to run the algoDesc algorithm.

**Returns****CUDNN\_STATUS\_SUCCESS**

The object was set successfully.

**CUDNN\_STATUS\_BAD\_PARAM**

`mode` or `reluNanOpt` has an invalid enumerant value.

## 4.176. cudnnSetAttnDescriptor

```

cudnnStatus_t cudnnSetAttnDescriptor(
cudnnAttnDescriptor_t attnDesc,
cudnnAttnQueryMap_t queryMap,
int nHeads,
double smScaler,
cudnnDataType_t dataType,
cudnnDataType_t computePrec,
cudnnMathType_t mathType,
cudnnDropoutDescriptor_t attnDropoutDesc,
cudnnDropoutDescriptor_t postDropoutDesc,
int qSize,
int kSize,
int vSize,
int qProjSize,
int kProjSize,
int vProjSize,
int oProjSize,
int qoMaxSeqLength,
int kvMaxSeqLength,
int maxBatchSize,
int maxBeamSize);

```

This function initializes a multi-head attention descriptor that was previously created using the [cudnnCreateAttnDescriptor](#) function.

For query, key, and value input data, the effective projection size is equal to the respective **[qkv]ProjSize** when the value is positive, and is equal to **[qkv]Size** otherwise.

The output projection size decides the hidden vector size of the forward output sequence data. It is equal to **oProjSize** when the value is positive, otherwise is equal to **nHeads** times effective value-projection size.

#### Parameters:

Parameter	Input / Output	Description
attnDesc	Output	Attention descriptor whose values are to be initialized.
queryMap	Input	Query mapping mode.
nHeads	Input	Number of attention heads.
smScaler	Input	Softmax smoothing, or sharpening, coefficient.
dataType	Input	Data type for Q,K,V inputs, weights, and the output.
computePrec	Input	Compute data type (precision).
mathType	Input	The Tensor Core Operations settings.
attnDropoutDesc	Input	Dropout descriptor for the dropout at the attention layer.
postDropoutDesc	Input	Dropout descriptor for the dropout at the output.
qSize, kSize, vSize	Input	Hidden size of Q, K, and V input sequence data.
qProjSize, kProjSize, vProjSize	Input	Hidden size of projected Q, K and V sequence data; 0 if no projection.
oProjSize	Input	Output projection size.
qoMaxSeqLength	Input	Largest sequence length allowed in sequence data Q and O.
kvMaxSeqLength	Input	Largest sequence length allowed in sequence data K and V.
maxBatchSize	Input	Largest batch size allowed in sequence data.
maxBeamSize	Input	Largest beam size allowed in sequence data.

#### Returns:

Return Value	Description
CUDNN_STATUS_SUCCESS	The <b>attnDesc</b> field values are updated successfully.
CUDNN_STATUS_BAD_PARAM	An invalid input value is encountered. For example: <ul style="list-style-type: none"> <li>- <b>attnDesc</b> is NULL</li> <li>- <b>queryMap</b> is not one of enumerated labels of <b> cudnnAttnQueryMap_t</b></li> </ul>

	<ul style="list-style-type: none"> <li>- Effective Q, K projection size are not equal (see remark below)</li> <li>- <code>dataType</code>, <code>computePrec</code>, <code>mathType</code> are invalid</li> </ul> <p>Any of the following valid ranges are violated:</p> <ul style="list-style-type: none"> <li>- <code>nHeads</code>, <code>qSize</code>, <code>kSize</code>, <code>vSize</code>, <code>qoMaxSeqLength</code>, <code>kvMaxSeqLength</code>, <code>maxBatchSize</code>, <code>maxBeamSize</code> <math>\geq 1</math></li> <li>- <code>qProjSize</code>, <code>kProjSize</code>, <code>vProjSize</code> <math>\geq 0</math></li> <li>- <code>smScaler</code> <math>\geq 0.0</math></li> </ul>
CUDNN_STATUS_NOT_SUPPORTED	An unsupported value is encountered.

## 4.177. cudnnSetCallback

```

cudnnStatus_t cudnnSetCallback(
    unsigned      mask,
    void          *udata,
    cudnnCallback_t  fptr)

```

**(New for 7.1)**

This function sets the internal states of cuDNN error reporting functionality.

### Parameters

#### mask

*Input.* An unsigned integer. The four least significant bits (LSBs) of this unsigned integer are used for switching on and off the different levels of error reporting messages. This applies for both the default callbacks, and for the customized callbacks. The bit position is in correspondence with the enum of `cudnnSeverity_t`. The user may utilize the predefined macros `CUDNN_SEV_ERROR_EN`, `CUDNN_SEV_WARNING_EN`, and `CUDNN_SEV_INFO_EN` to form the bit mask. When a bit is set to 1, the corresponding message channel is enabled.

For example, when bit 3 is set to 1, the API logging is enabled. Currently only the log output of level `CUDNN_SEV_INFO` is functional; the others are not yet implemented. When used for turning on and off the logging with the default callback, the user may pass `NULL` to `udata` and `fptr`. In addition, the environment variable `CUDNN_LOGDEST_DBG` must be set (see Section 2.11).

`CUDNN_SEV_INFO_EN` = 0b1000 (functional).

`CUDNN_SEV_ERROR_EN` = 0b0010 (not yet functional).

`CUDNN_SEV_WARNING_EN` = 0b0100 (not yet functional).

The output of `CUDNN_SEV_FATAL` is always enabled, and cannot be disabled.

#### udata

*Input.* A pointer provided by the user. This pointer will be passed to the user's custom logging callback function. The data it points to will not be read, nor be changed by cuDNN. This pointer may be used in many ways, such as in a mutex or in a communication socket for the user's callback function for logging. If the user

is utilizing the default callback function, or doesn't want to use this input in the customized callback function, they may pass in NULL.

### fptr

*Input.* A pointer to a user-supplied callback function. When NULL is passed to this pointer, then cuDNN switches back to the built-in default callback function. The user-supplied callback function prototype must be similar to the following (also defined in the header file):

```
void customizedLoggingCallback (cudnnSeverity_t sev, void *udata,
const cudnnDebug_t *dbg, const char *msg);
```

- ▶ The structure `cudnnDebug_t` is defined in the header file. It provides the metadata, such as time, time since start, stream ID, process and thread ID, that the user may choose to print or store in their customized callback.
- ▶ The variable `msg` is the logging message generated by cuDNN. Each line of this message is terminated by `"\0"`, and the end of message is terminated by `"\0\0"`. User may select what is necessary to show in the log, and may reformat the string.

### Returns

**CUDNN\_STATUS\_SUCCESS**

The function launched successfully.

## 4.178. cudnnSetConvolution2dDescriptor

```
cudnnStatus_t cudnnSetConvolution2dDescriptor(
    cudnnConvolutionDescriptor_t    convDesc,
    int                             pad_h,
    int                             pad_w,
    int                             u,
    int                             v,
    int                             dilation_h,
    int                             dilation_w,
    cudnnConvolutionMode_t         mode,
    cudnnDataType_t                computeType)
```

This function initializes a previously created convolution descriptor object into a 2D correlation. This function assumes that the tensor and filter descriptors corresponds to the forward convolution path and checks if their settings are valid. That same convolution descriptor can be reused in the backward path provided it corresponds to the same layer.

### Parameters

#### convDesc

*Input/Output.* Handle to a previously created convolution descriptor.

#### pad\_h

*Input.* zero-padding height: number of rows of zeros implicitly concatenated onto the top and onto the bottom of input images.

**pad\_w**

*Input.* zero-padding width: number of columns of zeros implicitly concatenated onto the left and onto the right of input images.

**u**

*Input.* Vertical filter stride.

**v**

*Input.* Horizontal filter stride.

**dilation\_h**

*Input.* Filter height dilation.

**dilation\_w**

*Input.* Filter width dilation.

**mode**

*Input.* Selects between `CUDNN_CONVOLUTION` and `CUDNN_CROSS_CORRELATION`.

**computeType**

*Input.* compute precision.

The possible error values returned by this function and their meanings are listed below.

**Returns****CUDNN\_STATUS\_SUCCESS**

The object was set successfully.

**CUDNN\_STATUS\_BAD\_PARAM**

At least one of the following conditions are met:

- ▶ The descriptor `convDesc` is nil.
- ▶ One of the parameters `pad_h`, `pad_w` is strictly negative.
- ▶ One of the parameters `u`, `v` is negative or zero.
- ▶ One of the parameters `dilation_h`, `dilation_w` is negative or zero.
- ▶ The parameter `mode` has an invalid enumerant value.

## 4.179. cudnnSetConvolutionGroupCount

```

cudnnStatus_t cudnnSetConvolutionGroupCount(
    cudnnConvolutionDescriptor_t convDesc,
    int groupCount)

```

This function allows the user to specify the number of groups to be used in the associated convolution.

**Returns****CUDNN\_STATUS\_SUCCESS**

The group count was set successfully.

**CUDNN\_STATUS\_BAD\_PARAM**

An invalid convolution descriptor was provided

## 4.180. cudnnSetConvolutionMathType

```

cudnnStatus_t cudnnSetConvolutionMathType(
    cudnnConvolutionDescriptor_t    convDesc,
    cudnnMathType_t                 mathType)

```

This function allows the user to specify whether or not the use of tensor op is permitted in library routines associated with a given convolution descriptor.

**Returns****CUDNN\_STATUS\_SUCCESS**

The math type was set successfully.

**CUDNN\_STATUS\_BAD\_PARAM**

Either an invalid convolution descriptor was provided or an invalid math type was specified.

## 4.181. cudnnSetConvolutionNdDescriptor

```

cudnnStatus_t cudnnSetConvolutionNdDescriptor(
    cudnnConvolutionDescriptor_t    convDesc,
    int                               arrayLength,
    const int                         padA[],
    const int                         filterStrideA[],
    const int                         dilationA[],
    cudnnConvolutionMode_t           mode,
    cudnnDataType_t                   dataType)

```

This function initializes a previously created generic convolution descriptor object into a n-D correlation. That same convolution descriptor can be reused in the backward path provided it corresponds to the same layer. The convolution computation will be done in the specified **dataType**, which can be potentially different from the input/output tensors.

**Parameters****convDesc**

*Input/Output.* Handle to a previously created convolution descriptor.

**arrayLength**

*Input.* Dimension of the convolution.

**padA**

*Input.* Array of dimension **arrayLength** containing the zero-padding size for each dimension. For every dimension, the padding represents the number of extra zeros implicitly concatenated at the start and at the end of every element of that dimension.



**filterStrideA**

*Input.* Array of dimension **arrayLength** containing the filter stride for each dimension. For every dimension, the filter stride represents the number of elements to slide to reach the next start of the filtering window of the next point.

**dilationA**

*Input.* Array of dimension **arrayLength** containing the dilation factor for each dimension.

**mode**

*Input.* Selects between **CUDNN\_CONVOLUTION** and **CUDNN\_CROSS\_CORRELATION**.

**datatype**

*Input.* Selects the datatype in which the computation will be done.

The possible error values returned by this function and their meanings are listed below.

**Returns****CUDNN\_STATUS\_SUCCESS**

The object was set successfully.

**CUDNN\_STATUS\_BAD\_PARAM**

At least one of the following conditions are met:

- ▶ The descriptor **convDesc** is nil.
- ▶ The **arrayLengthRequest** is negative.
- ▶ The enumerant **mode** has an invalid value.
- ▶ The enumerant **datatype** has an invalid value.
- ▶ One of the elements of **padA** is strictly negative.
- ▶ One of the elements of **strideA** is negative or zero.
- ▶ One of the elements of **dilationA** is negative or zero.

**CUDNN\_STATUS\_NOT\_SUPPORTED**

At least one of the following conditions are met:

- ▶ The **arrayLengthRequest** is greater than **CUDNN\_DIM\_MAX**.

## 4.182. cudnnSetConvolutionReorderType

```

cudnnStatus_t cudnnSetConvolutionReorderType(
    cudnnConvolutionDescriptor_t convDesc,
    cudnnReorderType_t reorderType);

```

This function sets the convolution reorder type for the given convolution descriptor.

**Parameters:**

Parameter	Input / Output	Description
convDesc	Input	The convolution descriptor for which the reorder type should be set.

reorderType	Input	Set the reorder type to this value. See <a href="#">cudnnReorderType_t</a> .
-------------	-------	--

**Returns:**

Return Value	Description
CUDNN_STATUS_BAD_PARAM	The reorder type supplied is not supported.
CUDNN_STATUS_SUCCESS	Reorder type is set successfully.

## 4.183. cudnnSetCTCLossDescriptor

```

cudnnStatus_t cudnnSetCTCLossDescriptor(
    cudnnCTCLossDescriptor_t      ctcLossDesc,
    cudnnDataType_t               compType)

```

This function sets a CTC loss function descriptor. See also the extended version [cudnnSetCTCLossDescriptorEx](#) to set the input normalization mode.

When the extended version **cudnnSetCTCLossDescriptorEx** is used with **normMode** set to CUDNN\_LOSS\_NORMALIZATION\_NONE and the **gradMode** set to CUDNN\_NOT\_PROPAGATE\_NAN, then it is the same as the current function **cudnnSetCTCLossDescriptor**, i.e.,

```

cudnnSetCtcLossDescriptor(*) = cudnnSetCtcLossDescriptorEx(*,
    normMode=CUDNN_LOSS_NORMALIZATION_NONE, gradMode=CUDNN_NOT_PROPAGATE_NAN)

```

**Parameters****ctcLossDesc**

*Output.* CTC loss descriptor to be set.

**compType**

*Input.* Compute type for this CTC loss function.

**Returns****CUDNN\_STATUS\_SUCCESS**

The function returned successfully.

**CUDNN\_STATUS\_BAD\_PARAM**

At least one of input parameters passed is invalid.

## 4.184. cudnnSetCTCLossDescriptorEx

```

cudnnStatus_t cudnnSetCTCLossDescriptorEx(
    cudnnCTCLossDescriptor_t      ctcLossDesc,
    cudnnDataType_t               compType,
    cudnnLossNormalizationMode_t  normMode,
    cudnnNanPropagation_t         gradMode)

```

This function is an extension of [cudnnSetCTCLossDescriptor](#). This function provides an additional interface **normMode** to set the input normalization mode for the CTC loss function, and **gradMode** to control the NaN propagation type.

When this function `cudaSetCTCLossDescriptorEx` is used with `normMode` set to `CUDNN_LOSS_NORMALIZATION_NONE` and the `gradMode` set to `CUDNN_NOT_PROPAGATE_NAN`, then it is the same as `cudaSetCTCLossDescriptor`, i.e.,

```
cudaSetCtcLossDescriptor(*) = cudaSetCtcLossDescriptorEx(*,
    normMode=CUDNN_LOSS_NORMALIZATION_NONE, gradMode=CUDNN_NOT_PROPAGATE_NAN)
```

### Parameters

#### `ctcLossDesc`

*Output.* CTC loss descriptor to be set.

#### `compType`

*Input.* Compute type for this CTC loss function.

#### `normMode`

*Input.* Input normalization type for this CTC loss function. See also [cudaLossNormalizationMode\\_t](#).

#### `gradMode`

*Input.* NaN propagation type for this CTC loss function. For `L` the sequence length, `R` the number of repeated letters in the sequence, and `T` the length of sequential data, the following applies: When a sample with `L+R > T` is encountered during the gradient calculation, if `gradMode` is set to `CUDNN_PROPAGATE_NAN` (see [cudaNanPropagation\\_t](#)), then the CTC loss function does not write to the gradient buffer for that sample. Instead, the current values, even not finite, are retained. If `gradMode` is set to `CUDNN_NOT_PROPAGATE_NAN`, then the gradient for that sample is set to zero. This guarantees finite gradient.

### Returns

#### `CUDNN_STATUS_SUCCESS`

The function returned successfully.

#### `CUDNN_STATUS_BAD_PARAM`

At least one of input parameters passed is invalid.

## 4.185. cudaSetDropoutDescriptor

```
cudaStatus_t cudaSetDropoutDescriptor(
    cudaDropoutDescriptor_t dropoutDesc,
    cudaHandle_t handle,
    float dropout,
    void *states,
    size_t stateSizeInBytes,
    unsigned long long seed)
```

This function initializes a previously created dropout descriptor object. If `states` argument is equal to `NULL`, random number generator states won't be initialized, and only `dropout` value will be set. No other function should be writing to the memory pointed at by `states` argument while this function is running. The user is expected not to change memory pointed at by `states` for the duration of the computation.

**Parameters****dropoutDesc**

*Input/Output.* Previously created dropout descriptor object.

**handle**

*Input.* Handle to a previously created cuDNN context.

**dropout**

*Input.* The probability with which the value from input is set to zero during the dropout layer.

**states**

*Output.* Pointer to user-allocated GPU memory that will hold random number generator states.

**stateSizeInBytes**

*Input.* Specifies size in bytes of the provided memory for the states

**seed**

*Input.* Seed used to initialize random number generator states.

The possible error values returned by this function and their meanings are listed below.

**Returns****CUDNN\_STATUS\_SUCCESS**

The call was successful.

**CUDNN\_STATUS\_INVALID\_VALUE**

**sizeInBytes** is less than the value returned by `cudaDnnDropoutGetStatesSize`.

**CUDNN\_STATUS\_EXECUTION\_FAILED**

The function failed to launch on the GPU

## 4.186. `cudaDnnSetFilter4dDescriptor`

```
cudaDnnStatus_t cudaDnnSetFilter4dDescriptor(
    cudaDnnFilterDescriptor_t  filterDesc,
    cudaDnnDataType_t         dataType,
    cudaDnnTensorFormat_t     format,
    int                        k,
    int                        c,
    int                        h,
    int                        w)
```

This function initializes a previously created filter descriptor object into a 4D filter. The layout of the filters must be contiguous in memory.

Tensor format `CUDNN_TENSOR_NHWC` has limited support in `cudaDnnConvolutionForward`, `cudaDnnConvolutionBackwardData` and `cudaDnnConvolutionBackwardFilter`; please refer to the documentation for each function for more information.

**Parameters**

**filterDesc**

*Input/Output.* Handle to a previously created filter descriptor.

**datatype**

*Input.* Data type.

**format**

*Input.* Type of the filter layout format. If this input is set to CUDNN\_TENSOR\_NCHW, which is one of the enumerated values allowed by `cuda::dnn::TensorFormat_t` descriptor, then the layout of the filter is in the form of KCRS (K represents the number of output feature maps, C the number of input feature maps, R the number of rows per filter, and S the number of columns per filter.)

If this input is set to CUDNN\_TENSOR\_NHWC, then the layout of the filter is in the form of KRSC. See also the description for `cuda::dnn::TensorFormat_t`.

**k**

*Input.* Number of output feature maps.

**c**

*Input.* Number of input feature maps.

**h**

*Input.* Height of each filter.

**w**

*Input.* Width of each filter.

The possible error values returned by this function and their meanings are listed below.

**Returns****CUDNN\_STATUS\_SUCCESS**

The object was set successfully.

**CUDNN\_STATUS\_BAD\_PARAM**

At least one of the parameters **k**, **c**, **h**, **w** is negative or **datatype** or **format** has an invalid enumerant value.

## 4.187. `cuda::dnn::setFilterNdDescriptor`

```

cuda::dnn::Status_t cuda::dnn::setFilterNdDescriptor(
    cuda::dnn::FilterDescriptor_t filterDesc,
    cuda::dnn::DataType_t        dataType,
    cuda::dnn::TensorFormat_t    format,
    int                           nbDims,
    const int                     filterDimA[])

```

This function initializes a previously created filter descriptor object. The layout of the filters must be contiguous in memory.

The tensor format CUDNN\_TENSOR\_NHWC has limited support in `cuda::dnn::ConvolutionForward`, `cuda::dnn::ConvolutionBackwardData` and

**cudaConvolutionBackwardFilter**; please refer to the documentation for each function for more information.

## Parameters

### filterDesc

*Input/Output.* Handle to a previously created filter descriptor.

### datatype

*Input.* Data type.

### format

*Input.* Type of the filter layout format. If this input is set to CUDNN\_TENSOR\_NCHW, which is one of the enumerated values allowed by **cudaTensorFormat\_t** descriptor, then the layout of the filter is as follows:

- ▶ For N=4, i.e., for a 4D filter descriptor, the filter layout is in the form of KCRS (K represents the number of output feature maps, C the number of input feature maps, R the number of rows per filter, and S the number of columns per filter.)
- ▶ For N=3, i.e., for a 3D filter descriptor, the number S (number of columns per filter) is omitted.
- ▶ For N=5 and greater, the layout of the higher dimensions immediately follow RS.

On the other hand, if this input is set to CUDNN\_TENSOR\_NHWC, then the layout of the filter is as follows:

- ▶ For N=4, i.e., for a 4D filter descriptor, the filter layout is in the form of KRSC.
- ▶ For N=3, i.e., for a 3D filter descriptor, the number S (number of columns per filter) is omitted, and the layout of C immediately follows R.
- ▶ For N=5 and greater, the layout of the higher dimensions are inserted between S and C. See also the description for **cudaTensorFormat\_t**.

### nbDims

*Input.* Dimension of the filter.

### filterDimA

*Input.* Array of dimension **nbDims** containing the size of the filter for each dimension.

The possible error values returned by this function and their meanings are listed below.

## Returns

### CUDNN\_STATUS\_SUCCESS

The object was set successfully.

### CUDNN\_STATUS\_BAD\_PARAM

At least one of the elements of the array **filterDimA** is negative or **dataType** or **format** has an invalid enumerant value.

### CUDNN\_STATUS\_NOT\_SUPPORTED

The parameter **nbDims** exceeds CUDNN\_DIM\_MAX.

## 4.188. cudnnSetFusedOpsConstParamPackAttribute

```

cudnnStatus_t cudnnSetFusedOpsConstParamPackAttribute(
    cudnnFusedOpsConstParamPack_t constPack,
    cudnnFusedOpsConstParamLabel_t paramLabel,
    const void *param);

```

This function sets the descriptor pointed to by the `param` pointer input. The type of the descriptor to be set is indicated by the enum value of `paramLabel` input.

### Parameters:

Parameter	Input / Output	Description
<code>constPack</code>	Input	The opaque <code>cudnnFusedOpsConstParamPack_t</code> structure that contains the various problem size information, such as the shape, layout and the type of Tensors, the descriptors for convolution and activation, and settings for operations such as convolution and activation.
<code>paramLabel</code>	Input	Several types of descriptors can be set by this setter function. The <code>param</code> input points to the descriptor itself, and this input indicates the type of the descriptor pointed to by the <code>param</code> input. The <code>cudnnFusedOpsConstParamLabel_t</code> enumerated type enables the selection of the type of the descriptor. See the <code>param</code> description below.
<code>param</code>	Input	Data pointer, to the host memory, associated with the specific descriptor. The type of the descriptor depends on the value of <code>paramLabel</code> . See the table in <code>cudnnFusedOpsConstParamLabel_t</code> .  If this pointer is set to NULL, then the cuDNN library will record as such. If not, then the values pointed to by this pointer (i.e., the value or the opaque structure underneath) will be copied into the <code>constPack</code> during <code>cudnnSetFusedOpsConstParamPackAttribute()</code> operation.

### Returns:

Return Value	Description
<code>CUDNN_STATUS_SUCCESS</code>	The descriptor is set successfully.
<code>CUDNN_STATUS_BAD_PARAM</code>	If <code>constPack</code> is NULL, or if <code>paramLabel</code> or the <code>ops</code> setting for <code>constPack</code> is invalid.

## 4.189. cudnnSetFusedOpsVariantParamPackAttribute

```

cudnnStatus_t cudnnSetFusedOpsVariantParamPackAttribute(
    cudnnFusedOpsVariantParamPack_t varPack,
    cudnnFusedOpsVariantParamLabel_t paramLabel,
    void *ptr);

```

This function sets the variable parameter pack descriptor.

### Parameters:

Parameter	Input / Output	Description
varPack	Input	Pointer to the cudnnFusedOps variant parameter pack ( <b>varPack</b> ) descriptor.
paramLabel	Input	Type to which the buffer pointer parameter (in the <b>varPack</b> descriptor) is set by this function. See <a href="#">cudnnFusedOpsConstParamLabel_t</a> .
ptr	Input	Pointer, to the host or device memory, to the value to which the descriptor parameter is set. The data type of the pointer, and the host/device memory location, depend on the <b>paramLabel</b> input selection. See <a href="#">cudnnFusedOpsVariantParamLabel_t</a> .

### Returns:

Return Value	Description
CUDNN_STATUS_BAD_PARAM	If <b>varPack</b> is NULL or if <b>paramLabel</b> is set to an unsupported value.
CUDNN_STATUS_SUCCESS	The descriptor was set successfully.

## 4.190. cudnnSetLRNDescriptor

```

cudnnStatus_t cudnnSetLRNDescriptor(
    cudnnLRNDescriptor_t normDesc,
    unsigned int lrnN,
    double lrnAlpha,
    double lrnBeta,
    double lrnK);

```

This function initializes a previously created LRN descriptor object.



Macros CUDNN\_LRN\_MIN\_N, CUDNN\_LRN\_MAX\_N, CUDNN\_LRN\_MIN\_K, CUDNN\_LRN\_MIN\_BETA defined in cudnn.h specify valid ranges for parameters.



Values of double parameters will be cast down to the tensor datatype during computation.



**Parameters****normDesc**

*Output.* Handle to a previously created LRN descriptor.

**lrnN**

*Input.* Normalization window width in elements. LRN layer uses a window [center-lookBehind, center+lookAhead], where lookBehind = floor( (lrnN-1)/2 ), lookAhead = lrnN-lookBehind-1. So for n=10, the window is [k-4...k...k+5] with a total of 10 samples. For DivisiveNormalization layer the window has the same extents as above in all 'spatial' dimensions (dimA[2], dimA[3], dimA[4]). By default lrnN is set to 5 in cudnnCreateLRNDescriptor.

**lrnAlpha**

*Input.* Value of the alpha variance scaling parameter in the normalization formula. Inside the library code this value is divided by the window width for LRN and by (window width)^#spatialDimensions for DivisiveNormalization. By default this value is set to 1e-4 in cudnnCreateLRNDescriptor.

**lrnBeta**

*Input.* Value of the beta power parameter in the normalization formula. By default this value is set to 0.75 in cudnnCreateLRNDescriptor.

**lrnK**

*Input.* Value of the k parameter in normalization formula. By default this value is set to 2.0.

Possible error values returned by this function and their meanings are listed below.

**Returns****CUDNN\_STATUS\_SUCCESS**

The object was set successfully.

**CUDNN\_STATUS\_BAD\_PARAM**

One of the input parameters was out of valid range as described above.

## 4.191. cudnnSetOpTensorDescriptor

```

cudnnStatus_t cudnnSetOpTensorDescriptor(
    cudnnOpTensorDescriptor_t  opTensorDesc,
    cudnnOpTensorOp_t          opTensorOp,
    cudnnDataType_t            opTensorCompType,
    cudnnNanPropagation_t      opTensorNanOpt)

```

This function initializes a Tensor Pointwise math descriptor.

**Parameters****opTensorDesc**

*Output.* Pointer to the structure holding the description of the Tensor Pointwise math descriptor.

**opTensorOp**

*Input.* Tensor Pointwise math operation for this Tensor Pointwise math descriptor.

**opTensorCompType**

*Input.* Computation datatype for this Tensor Pointwise math descriptor.

**opTensorNanOpt**

*Input.* NAN propagation policy

**Returns****CUDNN\_STATUS\_SUCCESS**

The function returned successfully.

**CUDNN\_STATUS\_BAD\_PARAM**

At least one of input parameters passed is invalid.

## 4.192. cudnnSetPersistentRNNPlan

```

cudnnStatus_t cudnnSetPersistentRNNPlan(
    cudnnRNNDescriptor_t      rnnDesc,
    cudnnPersistentRNNPlan_t  plan)

```

This function sets the persistent RNN plan to be executed when using **rnnDesc** and **CUDNN\_RNN\_ALGO\_PERSIST\_DYNAMIC** algo.

**Returns****CUDNN\_STATUS\_SUCCESS**

The plan was set successfully.

**CUDNN\_STATUS\_BAD\_PARAM**

The algo selected in **rnnDesc** is not **CUDNN\_RNN\_ALGO\_PERSIST\_DYNAMIC**.

## 4.193. cudnnSetPooling2dDescriptor

```

cudnnStatus_t cudnnSetPooling2dDescriptor(
    cudnnPoolingDescriptor_t  poolingDesc,
    cudnnPoolingMode_t        mode,
    cudnnNanPropagation_t     maxpoolingNanOpt,
    int                        windowHeight,
    int                        windowWidth,
    int                        verticalPadding,
    int                        horizontalPadding,
    int                        verticalStride,
    int                        horizontalStride)

```

This function initializes a previously created generic pooling descriptor object into a 2D description.

**Parameters****poolingDesc**

*Input/Output.* Handle to a previously created pooling descriptor.

**mode**

*Input.* Enumerant to specify the pooling mode.

**maxpoolingNanOpt**

*Input.* Enumerant to specify the Nan propagation mode.

**windowHeight**

*Input.* Height of the pooling window.

**windowWidth**

*Input.* Width of the pooling window.

**verticalPadding**

*Input.* Size of vertical padding.

**horizontalPadding**

*Input.* Size of horizontal padding

**verticalStride**

*Input.* Pooling vertical stride.

**horizontalStride**

*Input.* Pooling horizontal stride.

The possible error values returned by this function and their meanings are listed below.

**Returns****CUDNN\_STATUS\_SUCCESS**

The object was set successfully.

**CUDNN\_STATUS\_BAD\_PARAM**

At least one of the parameters **windowHeight**, **windowWidth**, **verticalStride**, **horizontalStride** is negative or **mode** or **maxpoolingNanOpt** has an invalid enumerant value.

## 4.194. cudnnSetPoolingNdDescriptor

```

cudnnStatus_t cudnnSetPoolingNdDescriptor(
    cudnnPoolingDescriptor_t poolingDesc,
    const cudnnPoolingMode_t mode,
    const cudnnNanPropagation_t maxpoolingNanOpt,
    int nbDims,
    const int windowDimA[],
    const int paddingA[],
    const int strideA[])

```

This function initializes a previously created generic pooling descriptor object.

**Parameters****poolingDesc**

*Input/Output.* Handle to a previously created pooling descriptor.

**mode**

*Input.* Enumerant to specify the pooling mode.

**maxpoolingNanOpt**

*Input.* Enumerant to specify the Nan propagation mode.

**nbDims**

*Input.* Dimension of the pooling operation. Must be greater than zero.

**windowDimA**

*Input.* Array of dimension **nbDims** containing the window size for each dimension. The value of array elements must be greater than zero.

**paddingA**

*Input.* Array of dimension **nbDims** containing the padding size for each dimension. Negative padding is allowed.

**strideA**

*Input.* Array of dimension **nbDims** containing the striding size for each dimension. The value of array elements must be greater than zero (i.e., negative striding size is not allowed).

**Returns****CUDNN\_STATUS\_SUCCESS**

The object was initialized successfully.

**CUDNN\_STATUS\_NOT\_SUPPORTED**

If (**nbDims** > CUDNN\_DIM\_MAX - 2).

**CUDNN\_STATUS\_BAD\_PARAM**

Either **nbDims**, or at least one of the elements of the arrays **windowDimA**, or **strideA** is negative, or **mode** or **maxpoolingNanOpt** has an invalid enumerant value.

## 4.195. cudnnSetReduceTensorDescriptor

```

cudnnStatus_t cudnnSetReduceTensorDescriptor(
    cudnnReduceTensorDescriptor_t  reduceTensorDesc,
    cudnnReduceTensorOp_t          reduceTensorOp,
    cudnnDataType_t                reduceTensorCompType,
    cudnnNanPropagation_t          reduceTensorNanOpt,
    cudnnReduceTensorIndices_t     reduceTensorIndices,
    cudnnIndicesType_t             reduceTensorIndicesType)

```

This function initializes a previously created reduce tensor descriptor object.

**Parameters****reduceTensorDesc**

*Input/Output.* Handle to a previously created reduce tensor descriptor.

**reduceTensorOp**

*Input.* Enumerant to specify the reduce tensor operation.

**reduceTensorCompType**

*Input.* Enumerant to specify the computation datatype of the reduction.

**reduceTensorNanOpt**

*Input.* Enumerant to specify the Nan propagation mode.

**reduceTensorIndices**

*Input.* Enumerant to specify the reduce tensor indices.

**reduceTensorIndicesType**

*Input.* Enumerant to specify the reduce tensor indices type.

**Returns****CUDNN\_STATUS\_SUCCESS**

The object was set successfully.

**CUDNN\_STATUS\_BAD\_PARAM**

reduceTensorDesc is NULL (reduceTensorOp, reduceTensorCompType, reduceTensorNanOpt, reduceTensorIndices or reduceTensorIndicesType has an invalid enumerant value).

## 4.196. cudnnSetRNNBiasMode

```

cudnnStatus_t cudnnSetRNNBiasMode(
    cudnnRNNDescriptor_t  rnnDesc,
    cudnnRNNBiasMode_t   biasMode)

```

The **cudnnSetRNNBiasMode()** function sets the number of bias vectors for a previously created and initialized RNN descriptor. This function should be called after **cudnnSetRNNDescriptor()** to enable the specified bias mode in an RNN. The default value of **biasMode** in **rnnDesc** after **cudnnCreateRNNDescriptor()** is **CUDNN\_RNN\_DOUBLE\_BIAS**.

**Parameters****rnnDesc**

*Input/Output.* A previously created RNN descriptor.

**biasMode**

*Input.* Sets the number of bias vectors. See [cudnnRNNBiasMode\\_t](#).

**Returns****CUDNN\_STATUS\_BAD\_PARAM**

Either the **rnnDesc** is NULL, or **biasMode** has an invalid enumerant value.

**CUDNN\_STATUS\_SUCCESS**

The **biasMode** was set successfully.

**CUDNN\_STATUS\_NOT\_SUPPORTED**

Non-default bias mode (an enumerated type besides `CUDNN_RNN_DOUBLE_BIAS`) applied to RNN algo other than `CUDNN_RNN_ALGO_STANDARD`.

## 4.197. cudnnSetRNNDataDescriptor

```

cudnnStatus_t cudnnSetRNNDataDescriptor(
    cudnnRNNDataDescriptor_t      RNNDataDesc,
    cudnnDataType_t               dataType,
    cudnnRNNDataLayout_t         layout,
    int                            maxSeqLength,
    int                            batchSize,
    int                            vectorSize,
    const int                     seqLengthArray[],
    void                           *paddingFill);

```

This function initializes a previously created RNN data descriptor object. This data structure is intended to support the unpacked (padded) layout for input and output of extended RNN inference and training functions. A packed (unpadded) layout is also supported for backward compatibility.

### Parameters

#### RNNDataDesc

*Input/Output.* A previously created RNN descriptor. See [cudnnRNNDataDescriptor\\_t](#).

#### dataType

*Input.* The datatype of the RNN data tensor. See [cudnnDataType\\_t](#).

#### layout

*Input.* The memory layout of the RNN data tensor.

#### maxSeqLength

*Input.* The maximum sequence length within this RNN data tensor. In the unpacked (padded) layout, this should include the padding vectors in each sequence. In the packed (unpadded) layout, this should be equal to the greatest element in **seqLengthArray**.

#### batchSize

*Input.* The number of sequences within the mini-batch.

#### vectorSize

*Input.* The vector length (i.e. embedding size) of the input or output tensor at each timestep.

#### seqLengthArray

*Input.* An integer array with **batchSize** number of elements. Describes the length (i.e. number of timesteps) of each sequence. Each element in **seqLengthArray** must be greater than 0 but less than or equal to **maxSeqLength**. In the packed layout, the elements should be sorted in descending order, similar to the layout required by the non-extended RNN compute functions.

## paddingFill

*Input.* A user-defined symbol for filling the padding position in RNN output. This is only effective when the descriptor is describing the RNN output, and the unpacked layout is specified. The symbol should be in the host memory, and is interpreted as the same data type as that of the RNN data tensor. If NULL pointer is passed in, then the padding position in the output will be undefined.

### Returns

#### CUDNN\_STATUS\_SUCCESS

The object was set successfully.

#### CUDNN\_STATUS\_NOT\_SUPPORTED

`dataType` is not one of `CUDNN_DATA_HALF`, `CUDNN_DATA_FLOAT`, `CUDNN_DATA_DOUBLE`.

#### CUDNN\_STATUS\_BAD\_PARAM

Any one of these have occurred:

- ▶ `RNNDataDesc` is NULL.
- ▶ Any one of `maxSeqLength`, `batchSize`, or `vectorSize` is less than or equal to zero.
- ▶ An element of `seqLengthArray` is less than or equal to zero or greater than `maxSeqLength`.
- ▶ Layout is not one of `CUDNN_RNN_DATA_LAYOUT_SEQ_MAJOR_UNPACKED`, `CUDNN_RNN_DATA_LAYOUT_SEQ_MAJOR_PACKED`, or `CUDNN_RNN_DATA_LAYOUT_BATCH_MAJOR_UNPACKED`.

#### CUDNN\_STATUS\_ALLOC\_FAILED

The allocation of internal array storage has failed.

## 4.198. cudnnSetRNNDescriptor

```

cudnnStatus_t cudnnSetRNNDescriptor(
    cudnnHandle_t          handle,
    cudnnRNNDescriptor_t  rnnDesc,
    int                   hiddenSize,
    int                   numLayers,
    cudnnDropoutDescriptor_t dropoutDesc,
    cudnnRNNInputMode_t   inputMode,
    cudnnDirectionMode_t  direction,
    cudnnRNNMode_t        mode,
    cudnnRNNAlgo_t        algo,
    cudnnDataType_t       mathPrec)

```

This function initializes a previously created RNN descriptor object.



Larger networks (e.g., longer sequences, more layers) are expected to be more efficient than smaller networks.

### Parameters

**rnnDesc**

*Input/Output.* A previously created RNN descriptor.

**hiddenSize**

*Input.* Size of the internal hidden state for each layer.

**numLayers**

*Input.* Number of stacked layers.

**dropoutDesc**

*Input.* Handle to a previously created and initialized dropout descriptor. Dropout will be applied between layers; a single layer network will have no dropout applied.

**inputMode**

*Input.* Specifies the behavior at the input to the first layer.

**direction**

*Input.* Specifies the recurrence pattern. (e.g., bidirectional).

**mode**

*Input.* Specifies the type of RNN to compute.

**mathPrec**

*Input.* Math precision. This parameter is used for controlling the math precision in RNN. The following applies:

- ▶ For the input/output in FP16, the parameter **mathPrec** can be CUDNN\_DATA\_HALF or CUDNN\_DATA\_FLOAT.
- ▶ For the input/output in FP32, the parameter **mathPrec** can only be CUDNN\_DATA\_FLOAT, and
- ▶ For the input/output in FP64, double type, the parameter **mathPrec** can only be CUDNN\_DATA\_DOUBLE.

**Returns****CUDNN\_STATUS\_SUCCESS**

The object was set successfully.

**CUDNN\_STATUS\_BAD\_PARAM**

Either at least one of the parameters **hiddenSize**, **numLayers** was zero or negative, one of **inputMode**, **direction**, **mode**, **dataType** has an invalid enumerant value, **dropoutDesc** is an invalid dropout descriptor or **rnnDesc** has not been created correctly.

## 4.199. cudnnSetRNNDescriptor\_v5

```

cudnnStatus_t cudnnSetRNNDescriptor_v5(
    cudnnRNNDescriptor_t    rnnDesc,
    int                     hiddenSize,
    int                     numLayers,
    cudnnDropoutDescriptor_t dropoutDesc,
    cudnnRNNInputMode_t    inputMode,

```



```

    cudnnDirectionMode_t    direction,
    cudnnRNNMode_t         mode,
    cudnnDataType_t        mathPrec)

```

This function initializes a previously created RNN descriptor object.



Larger networks (e.g., longer sequences, more layers) are expected to be more efficient than smaller networks.

## Parameters

### **rnnDesc**

*Input/Output.* A previously created RNN descriptor.

### **hiddenSize**

*Input.* Size of the internal hidden state for each layer.

### **numLayers**

*Input.* Number of stacked layers.

### **dropoutDesc**

*Input.* Handle to a previously created and initialized dropout descriptor. Dropout will be applied between layers (e.g., a single layer network will have no dropout applied).

### **inputMode**

*Input.* Specifies the behavior at the input to the first layer

### **direction**

*Input.* Specifies the recurrence pattern. (e.g., bidirectional)

### **mode**

*Input.* Specifies the type of RNN to compute.

### **mathPrec**

*Input.* Math precision. This parameter is used for controlling the math precision in RNN. The following applies:

- ▶ For the input/output in FP16, the parameter **mathPrec** can be CUDNN\_DATA\_HALF or CUDNN\_DATA\_FLOAT.
- ▶ For the input/output in FP32, the parameter **mathPrec** can only be CUDNN\_DATA\_FLOAT, and
- ▶ For the input/output in FP64, double type, the parameter **mathPrec** can only be CUDNN\_DATA\_DOUBLE.

The possible error values returned by this function and their meanings are listed below.

## Returns

### **CUDNN\_STATUS\_SUCCESS**

The object was set successfully.

### **CUDNN\_STATUS\_BAD\_PARAM**

Either at least one of the parameters **hiddenSize**, **numLayers** was zero or negative, one of **inputMode**, **direction**, **mode**, **algo**, **dataType** has an invalid

enumerant value, **dropoutDesc** is an invalid dropout descriptor or **rnnDesc** has not been created correctly.

## 4.200. cudnnSetRNNDescriptor\_v6

```

cudnnStatus_t cudnnSetRNNDescriptor_v6(
    cudnnHandle_t          handle,
    cudnnRNNDescriptor_t   rnnDesc,
    const int              hiddenSize,
    const int              numLayers,
    cudnnDropoutDescriptor_t dropoutDesc,
    cudnnRNNInputMode_t    inputMode,
    cudnnDirectionMode_t   direction,
    cudnnRNNMode_t         mode,
    cudnnRNNAlgo_t         algo,
    cudnnDataType_t        mathPrec)

```

This function initializes a previously created RNN descriptor object.



Larger networks (e.g., longer sequences, more layers) are expected to be more efficient than smaller networks.

### Parameters

#### handle

*Input.* Handle to a previously created cuDNN library descriptor.

#### rnnDesc

*Input/Output.* A previously created RNN descriptor.

#### hiddenSize

*Input.* Size of the internal hidden state for each layer.

#### numLayers

*Input.* Number of stacked layers.

#### dropoutDesc

*Input.* Handle to a previously created and initialized dropout descriptor. Dropout will be applied between layers (e.g., a single layer network will have no dropout applied).

#### inputMode

*Input.* Specifies the behavior at the input to the first layer

#### direction

*Input.* Specifies the recurrence pattern. (e.g., bidirectional)

#### mode

*Input.* Specifies the type of RNN to compute.

#### algo

*Input.* Specifies which RNN algorithm should be used to compute the results.

**mathPrec**

*Input.* Math precision. This parameter is used for controlling the math precision in RNN. The following applies:

- ▶ For the input/output in FP16, the parameter **mathPrec** can be CUDNN\_DATA\_HALF or CUDNN\_DATA\_FLOAT.
- ▶ For the input/output in FP32, the parameter **mathPrec** can only be CUDNN\_DATA\_FLOAT, and
- ▶ For the input/output in FP64, double type, the parameter **mathPrec** can only be CUDNN\_DATA\_DOUBLE.

The possible error values returned by this function and their meanings are listed below.

**Returns****CUDNN\_STATUS\_SUCCESS**

The object was set successfully.

**CUDNN\_STATUS\_BAD\_PARAM**

Either at least one of the parameters **hiddenSize**, **numLayers** was zero or negative, one of **inputMode**, **direction**, **mode**, **algo**, **dataType** has an invalid enumerant value, **dropoutDesc** is an invalid dropout descriptor or **rnnDesc** has not been created correctly.

## 4.201. cudnnSetRNNMatrixMathType

```

cudnnStatus_t cudnnSetRNNMatrixMathType(
    cudnnRNNDescriptor_t  rnnDesc,
    cudnnMathType_t      mType)

```

This function sets the preferred option to use NVIDIA Tensor Cores accelerators on Volta GPU-s (SM 7.0 or higher). When the **mType** parameter is CUDNN\_TENSOR\_OP\_MATH, inference and training RNN API-s will attempt use Tensor Cores when weights/biases are of type CUDNN\_DATA\_HALF or CUDNN\_DATA\_FLOAT. When RNN weights/biases are stored in the CUDNN\_DATA\_FLOAT format, the original weights and intermediate results will be down-converted to CUDNN\_DATA\_HALF before they are used in another recursive iteration.

**Parameters****rnnDesc**

*Input.* A previously created and initialized RNN descriptor.

**mType**

*Input.* A preferred compute option when performing RNN GEMM-s (general matrix-matrix multiplications). This option has an “advisory” status meaning that Tensor Cores may not be utilized, e.g., due to specific GEMM dimensions.

**Returns**

**CUDNN\_STATUS\_SUCCESS**

The preferred compute option for the RNN network was set successfully.

**CUDNN\_STATUS\_BAD\_PARAM**

An invalid input parameter was detected.

## 4.202. cudnnSetRNNPaddingMode

```

cudnnStatus_t cudnnSetRNNPaddingMode (
    cudnnRNNDescriptor_t      rnnDesc,
    cudnnRNNPaddingMode_t    paddingMode)

```

This function enables or disables the padded RNN input/output for a previously created and initialized RNN descriptor. This information is required before calling the **cudnnGetRNNWorkspaceSize** and **cudnnGetRNNTrainingReserveSize** functions, to determine whether additional workspace and training reserve space is needed. By default the padded RNN input/output is not enabled.

### Parameters

#### **rnnDesc**

*Input/Output.* A previously created RNN descriptor.

#### **paddingMode**

*Input.* Enables or disables the padded input/output. See the description for **cudnnRNNPaddingMode\_t**.

### Returns

**CUDNN\_STATUS\_SUCCESS**

The **paddingMode** was set successfully.

**CUDNN\_STATUS\_BAD\_PARAM**

Either the **rnnDesc** is NULL, or **paddingMode** has an invalid enumerant value.

## 4.203. cudnnSetRNNProjectionLayers

```

cudnnStatus_t cudnnSetRNNProjectionLayers (
    cudnnHandle_t      handle,
    cudnnRNNDescriptor_t  rnnDesc,
    int                recProjSize,
    int                outProjSize)

```

### (New for 7.1)

The **cudnnSetRNNProjectionLayers()** function should be called after **cudnnSetRNNDescriptor()** to enable the "recurrent" and/or "output" projection in a recursive neural network. The "recurrent" projection is an additional matrix multiplication in the LSTM cell to project hidden state vectors  $h_t$  into smaller vectors  $r_t = W_r h_t$ , where  $W_r$  is a rectangular matrix with **recProjSize** rows and **hiddenSize** columns. When the recurrent projection is enabled, the output of the LSTM cell (both to the next layer and unrolled in-time) is  $r_t$  instead of  $h_t$ . The dimensionality of  $i_t$ ,  $f_t$ ,  $o_t$ , and

$c_t$  vectors used in conjunction with non-linear functions remains the same as in the canonical LSTM cell. To make this possible, the shapes of matrices in the LSTM formulas (see the chapter describing the `cudaRNNMode_t` type), such as  $W_i$  in hidden RNN layers or  $R_i$  in the entire network, become rectangular versus square in the canonical LSTM mode. Obviously, the result of " $R_i * W_r$ " is a square matrix but it is rank deficient, reflecting the "compression" of LSTM output. The recurrent projection is typically employed when the number of independent (adjustable) weights in the RNN network with projection is smaller in comparison to canonical LSTM for the same hiddenSize value.

The "recurrent" projection can be enabled for LSTM cells and `CUDNN_RNN_ALGO_STANDARD` only. The `recProjSize` parameter should be smaller than the `hiddenSize` value programmed in the `cudaSetRNNDescrptor()` call. It is legal to set `recProjSize` equal to `hiddenSize` but in that case the recurrent projection feature is disabled.

The "output" projection is currently not implemented.

For more information on the "recurrent" and "output" RNN projections see the paper by Hasim Sak, *et al.*: Long Short-Term Memory Based Recurrent Neural Network Architectures For Large Vocabulary Speech Recognition.

## Parameters

### `handle`

*Input.* Handle to a previously created cuDNN library descriptor.

### `rnnDesc`

*Input.* A previously created and initialized RNN descriptor.

### `recProjSize`

*Input.* The size of the LSTM cell output after the "recurrent" projection. This value should not be larger than `hiddenSize` programmed via `cudaSetRNNDescrptor()`.

### `outProjSize`

*Input.* This parameter should be zero.

## Returns

### `CUDNN_STATUS_SUCCESS`

RNN projection parameters were set successfully.

### `CUDNN_STATUS_BAD_PARAM`

An invalid input argument was detected (e.g., NULL handles, negative values for projection parameters).

### `CUDNN_STATUS_NOT_SUPPORTED`

Projection applied to RNN algo other than `CUDNN_RNN_ALGO_STANDARD`, cell type other than `CUDNN_LSTM`, `recProjSize` larger than `hiddenSize`.

## 4.204. cudnnSetSeqDataDescriptor

```

cudnnStatus_t cudnnSetSeqDataDescriptor(
    cudnnSeqDataDescriptor_t seqDataDesc,
    cudnnDataType_t dataType,
    int nbDims,
    const int dimA[],
    const cudnnSeqDataAxis_t axes[],
    size_t seqLengthArraySize,
    const int seqLengthArray[],
    void *paddingFill);

```

This function initializes a previously created sequence data descriptor object. This descriptor points to a buffer that holds a batch of sequence samples. Each sample consists of a fixed beam size number of sequences.

Sequence data are regularly strided in memory with the order of time, batch, beam, and vector axes specified by the array `axes[]`.

Each sequence has different sequence length and is specified in `seqLengthArray`, an array of size `seqLengthArraySize`.

The value of `seqLengthArraySize` is `< dimA[CUDNN_SEQDATA_TIME_DIM]`.

### Parameters:

Parameter	Input / Output	Description
<code>seqDataDesc</code>	Output	Pointer to a previously created <code>cudnnSeqDataDescriptor</code> structure to initialize.
<code>dataType</code>	Input	Data type of the sequence data.
<code>nbDims</code>	Input	Number of sequence data dimensions.
<code>dimA[]</code>	Input	Size of each axes dimension. Array that contains the dimensions of the buffer that holds a batch of sequence samples. This <code>dimA</code> is an array of 4 positive integers, where: <ul style="list-style-type: none"> <li>- <code>dimA[CUDNN_SEQDATA_TIME_DIM]</code> is the maximum allowed sequence length</li> <li>- <code>dimA[CUDNN_SEQDATA_BATCH_DIM]</code> is the maximum allowed batch size</li> <li>- <code>dimA[CUDNN_SEQDATA_BEAM_DIM]</code> is the number of beam in each sample</li> <li>- <code>dimA[CUDNN_SEQDATA_VECT_DIM]</code> is the vector length.</li> </ul>
<code>axes[]</code>	Input	Array of axes, sorted from outermost to innermost dimension. The array size is <code>CUDNN_SEQDATA_DIM_COUNT</code> . The elements of <code>axes[]</code> array is a valid permutation of enumerated labels of <code>cudnnSeqDataAxis_t</code> (in the order from

		the outermost to the innermost axes in memory.)
<code>seqLengthArraySize</code>	Input	Number of elements in, i.e., the length of, the <code>seqLengthArray</code> . The value of this <code>seqLengthArraySize</code> is $< \text{dimA}[\text{CUDNN_SEQDATA\_TIME\_DIM}]$ .
<code>seqLengthArray[]</code>	Input	Array that holds the sequence lengths of each sequence.
<code>paddingFill</code>	Input	Points to a value, of <code>dataType</code> , that is used to fill up the buffer beyond the sequence length of each sequence. The only supported value for <code>paddingFill</code> is 0.

**Returns:**

Return Value	Description
<code>CUDNN_STATUS_SUCCESS</code>	All input values are validated and the descriptor value updated successfully.
<code>CUDNN_STATUS_BAD_PARAM</code>	Any of the below invalid inputs has occurred: <ul style="list-style-type: none"> <li>- <code>seqDataDesc == NULL</code></li> <li>- <code>dataType</code> is not a valid data type</li> <li>- <code>nbDims</code> is not positive.</li> <li>- Any element of <code>dimA</code> is not positive</li> <li>- <code>seqLengthArraySize</code> is not equal to <math>\text{dimA}[\text{CUDNN_SEQDATA\_BATCH\_DIM}] * \text{dimA}[\text{CUDNN_SEQDATA\_BEAM\_DIM}]</math></li> <li>- Any element of <code>seqLengthArray</code> is not positive</li> <li>- Any element of <code>seqLengthArray</code> is larger than <math>\text{dimA}[\text{CUDNN_SEQDATA\_TIME\_DIM}]</math></li> </ul>
<code>CUDNN_STATUS_NOT_SUPPORTED</code>	Encountered any of the below unsupported values: <ul style="list-style-type: none"> <li>- <code>nbDims</code> is not equal to <code>CUDNN_SEQDATA_DIM_COUNT (4)</code></li> <li>- <code>paddingFill</code> is not a NULL pointer, and the value pointed to is not of the <code>dataType</code>.</li> </ul>
<code>CUDNN_STATUS_ALLOC_FAILED</code>	Failed to allocate storage for some field of the descriptor structure.

## 4.205. cudnnSetSpatialTransformerNdDescriptor

```

cudnnStatus_t cudnnSetSpatialTransformerNdDescriptor(
    cudnnSpatialTransformerDescriptor_t  stDesc,
    cudnnSamplerType_t                  samplerType,
    cudnnDataType_t                      dataType,
    const int                             nbDims,
    const int                             dimA[])

```

This function initializes a previously created generic spatial transformer descriptor object.

### Parameters

#### **stDesc**

*Input/Output.* Previously created spatial transformer descriptor object.

#### **samplerType**

*Input.* Enumerant to specify the sampler type.

#### **dataType**

*Input.* Data type.

#### **nbDims**

*Input.* Dimension of the transformed tensor.

#### **dimA**

*Input.* Array of dimension **nbDims** containing the size of the transformed tensor for every dimension.

The possible error values returned by this function and their meanings are listed below.

### Returns

#### **CUDNN\_STATUS\_SUCCESS**

The call was successful.

#### **CUDNN\_STATUS\_BAD\_PARAM**

At least one of the following conditions are met:

- ▶ Either **stDesc** or **dimA** is NULL.
- ▶ Either **dataType** or **samplerType** has an invalid enumerant value

## 4.206. cudnnSetStream

```

cudnnStatus_t cudnnSetStream(
    cudnnHandle_t  handle,
    cudaStream_t   streamId)

```

This function sets the user's CUDA stream in the cuDNN handle. The new stream will be used to launch cuDNN GPU kernels or to synchronize to this stream when cuDNN kernels are launched in the internal streams. If the cuDNN library stream is not set, all kernels use the default (NULL) stream. Setting the user stream in the cuDNN handle guarantees the issue-order execution of cuDNN calls and other GPU kernels launched in the same stream.

### Parameters

#### **handle**

*Input.* Pointer to the cuDNN handle.



**streamID**

*Input.* New CUDA stream to be written to the cuDNN handle.

**Returns****CUDNN\_STATUS\_BAD\_PARAM**

Invalid (NULL) handle.

**CUDNN\_STATUS\_MAPPING\_ERROR**

Mismatch between the user stream and the cuDNN handle context.

**CUDNN\_STATUS\_SUCCESS**

The new stream was set successfully.

## 4.207. cudnnSetTensor4dDescriptor

```

cudnnStatus_t cudnnSetTensor4dDescriptor(
    cudnnTensorDescriptor_t tensorDesc,
    cudnnTensorFormat_t     format,
    cudnnDataType_t         dataType,
    int                      n,
    int                      c,
    int                      h,
    int                      w)

```

This function initializes a previously created generic Tensor descriptor object into a 4D tensor. The strides of the four dimensions are inferred from the format parameter and set in such a way that the data is contiguous in memory with no padding between dimensions.



The total size of a tensor including the potential padding between dimensions is limited to 2 Giga-elements of type `dataType`.

**Parameters****tensorDesc**

*Input/Output.* Handle to a previously created tensor descriptor.

**format**

*Input.* Type of format.

**dataType**

*Input.* Data type.

**n**

*Input.* Number of images.

**c**

*Input.* Number of feature maps per image.

**h**

*Input.* Height of each feature map.

**w***Input.* Width of each feature map.

The possible error values returned by this function and their meanings are listed below.

**Returns****CUDNN\_STATUS\_SUCCESS**

The object was set successfully.

**CUDNN\_STATUS\_BAD\_PARAM**At least one of the parameters **n**, **c**, **h**, **w** was negative or **format** has an invalid enumerant value or **dataType** has an invalid enumerant value.**CUDNN\_STATUS\_NOT\_SUPPORTED**

The total size of the tensor descriptor exceeds the maximim limit of 2 Giga-elements.

## 4.208. cudnnSetTensor4dDescriptorEx

```

cudnnStatus_t cudnnSetTensor4dDescriptorEx(
    cudnnTensorDescriptor_t  tensorDesc,
    cudnnDataType_t         dataType,
    int                      n,
    int                      c,
    int                      h,
    int                      w,
    int                      nStride,
    int                      cStride,
    int                      hStride,
    int                      wStride)

```

This function initializes a previously created generic Tensor descriptor object into a 4D tensor, similarly to **cudnnSetTensor4dDescriptor** but with the strides explicitly passed as parameters. This can be used to lay out the 4D tensor in any order or simply to define gaps between dimensions.



At present, some cuDNN routines have limited support for strides; Those routines will return **CUDNN\_STATUS\_NOT\_SUPPORTED** if a Tensor4D object with an unsupported stride is used. **cudnnTransformTensor** can be used to convert the data to a supported layout.



The total size of a tensor including the potential padding between dimensions is limited to 2 Giga-elements of type **dataType**.

**Parameters****tensorDesc***Input/Output.* Handle to a previously created tensor descriptor.**dataType***Input.* Data type.

**n***Input.* Number of images.**c***Input.* Number of feature maps per image.**h***Input.* Height of each feature map.**w***Input.* Width of each feature map.**nStride***Input.* Stride between two consecutive images.**cStride***Input.* Stride between two consecutive feature maps.**hStride***Input.* Stride between two consecutive rows.**wStride***Input.* Stride between two consecutive columns.

The possible error values returned by this function and their meanings are listed below.

**Returns****CUDNN\_STATUS\_SUCCESS**

The object was set successfully.

**CUDNN\_STATUS\_BAD\_PARAM**At least one of the parameters **n**, **c**, **h**, **w** or **nStride**, **cStride**, **hStride**, **wStride** is negative or **dataType** has an invalid enumerant value.**CUDNN\_STATUS\_NOT\_SUPPORTED**

The total size of the tensor descriptor exceeds the maximum limit of 2 Giga-elements.

## 4.209. cudnnSetTensor

```

cudnnStatus_t cudnnSetTensor(
    cudnnHandle_t          handle,
    const cudnnTensorDescriptor_t yDesc,
    void                  *y,
    const void             *valuePtr)

```

This function sets all the elements of a tensor to a given value.

**Parameters****handle***Input.* Handle to a previously created cuDNN context.

**yDesc**

*Input.* Handle to a previously initialized tensor descriptor.

**y**

*Input/Output.* Pointer to data of the tensor described by the **yDesc** descriptor.

**valuePtr**

*Input.* Pointer in Host memory to a single value. All elements of the y tensor will be set to value[0]. The data type of the element in value[0] has to match the data type of tensor **y**.

The possible error values returned by this function and their meanings are listed below.

**Returns****CUDNN\_STATUS\_SUCCESS**

The function launched successfully.

**CUDNN\_STATUS\_NOT\_SUPPORTED**

The function does not support the provided configuration.

**CUDNN\_STATUS\_BAD\_PARAM**

one of the provided pointers is nil

**CUDNN\_STATUS\_EXECUTION\_FAILED**

The function failed to launch on the GPU.

## 4.210. cudnnSetTensorNdDescriptor

```

cudnnStatus_t cudnnSetTensorNdDescriptor(
    cudnnTensorDescriptor_t tensorDesc,
    cudnnDataType_t         dataType,
    int                     nbDims,
    const int               dimA[],
    const int               strideA[])

```

This function initializes a previously created generic Tensor descriptor object.



The total size of a tensor including the potential padding between dimensions is limited to 2 Giga-elements of type `dataType`. Tensors are restricted to having at least 4 dimensions, and at most CUDNN\_DIM\_MAX dimensions (defined in cudnn.h). When working with lower dimensional data, it is recommended that the user create a 4D tensor, and set the size along unused dimensions to 1.

**Parameters****tensorDesc**

*Input/Output.* Handle to a previously created tensor descriptor.

**datatype**

*Input.* Data type.

**nbDims**

*Input.* Dimension of the tensor.



Do not use 2 dimensions. Due to historical reasons, the minimum number of dimensions in the filter descriptor is three. See also the `cudaGetRNNLinLayerBiasParams()`.

**dimA**

*Input.* Array of dimension **nbDims** that contain the size of the tensor for every dimension. Size along unused dimensions should be set to 1.

**strideA**

*Input.* Array of dimension **nbDims** that contain the stride of the tensor for every dimension.

The possible error values returned by this function and their meanings are listed below.

**Returns****CUDNN\_STATUS\_SUCCESS**

The object was set successfully.

**CUDNN\_STATUS\_BAD\_PARAM**

At least one of the elements of the array **dimA** was negative or zero, or **dataType** has an invalid enumerant value.

**CUDNN\_STATUS\_NOT\_SUPPORTED**

The parameter **nbDims** is outside the range [4, CUDNN\_DIM\_MAX], or the total size of the tensor descriptor exceeds the maximum limit of 2 Giga-elements.

## 4.211. cudnnSetTensorNdDescriptorEx

```

cudnnStatus_t cudnnSetTensorNdDescriptorEx(
    cudnnTensorDescriptor_t tensorDesc,
    cudnnTensorFormat_t    format,
    cudnnDataType_t        dataType,
    int                     nbDims,
    const int               dimA[])

```

This function initializes an n-D tensor descriptor.

**Parameters****tensorDesc**

*Output.* Pointer to the tensor descriptor struct to be initialized.

**format**

*Input.* Tensor format.

**dataType**

*Input.* Tensor data type.

**nbDims**

*Input.* Dimension of the tensor.



Do not use 2 dimensions. Due to historical reasons, the minimum number of dimensions in the filter descriptor is three. See also the `cudaGetRNINLayerBiasParams()`.

**dimA**

*Input.* Array containing size of each dimension.

**Returns****CUDNN\_STATUS\_SUCCESS**

The function was successful.

**CUDNN\_STATUS\_BAD\_PARAM**

Tensor descriptor was not allocated properly; or input parameters are not set correctly.

**CUDNN\_STATUS\_NOT\_SUPPORTED**

Dimension size requested is larger than maximum dimension size supported.

## 4.212. `cudaSetTensorTransformDescriptor`

```
cudaStatus_t cudaSetTensorTransformDescriptor(
    cudaTensorTransformDescriptor_t transformDesc,
    const uint32_t nbDims,
    const cudaTensorFormat_t destFormat,
    const int32_t padBeforeA[],
    const int32_t padAfterA[],
    const uint32_t foldA[],
    const cudaFoldingDirection_t direction);
```

This function initializes a Tensor transform descriptor that was previously created using the `cudaCreateTensorTransformDescriptor` function.

**Parameters:**

Parameter	Input / Output	Description
<code>transformDesc</code>	Output	The Tensor transform descriptor to be initialized.
<code>nbDims</code>	Input	The dimensionality of the transform operands. Must be greater than 2. See also <a href="https://docs.nvidia.com/deeplearning/sdk/cudnn-developer-guide/index.html#tensor-descriptor">https://docs.nvidia.com/deeplearning/sdk/cudnn-developer-guide/index.html#tensor-descriptor</a>
<code>destFormat</code>	Input	The desired destination format.
<code>padBeforeA[]</code>	Input	An array that contains the amount of padding that should be added before each dimension. Set to NULL for no padding.

padAfterA[]	Input	An array that contains the amount of padding that should be added after each dimension. Set to NULL for no padding.
foldA[]	Input	An array that contains the folding parameters for each spatial dimension (dimensions 2 and up). Set to NULL for no folding.
direction	Input	Selects folding or unfolding. This input has no effect when folding parameters are all <= 1. See <a href="#">cudnnFoldingDirection_t</a> .

Returns:

Return Value	Description
CUDNN_STATUS_SUCCESS	The function was launched successfully.
CUDNN_STATUS_BAD_PARAM	The parameter <code>transformDesc</code> is NULL, or if <code>direction</code> is invalid, or <code>nbDims</code> is <= 2.
CUDNN_STATUS_NOT_SUPPORTED	If the dimension size requested is larger than maximum dimension size supported (i.e., one of the <code>nbDims</code> is larger than CUDNN_DIM_MAX), or if <code>destFormat</code> is something other than NCHW or NHWC.

### 4.213. cudnnSoftmaxBackward

```

cudnnStatus_t cudnnSoftmaxBackward(
    cudnnHandle_t          handle,
    cudnnSoftmaxAlgorithm_t algorithm,
    cudnnSoftmaxMode_t    mode,
    const void             *alpha,
    const cudnnTensorDescriptor_t yDesc,
    const void             *yData,
    const cudnnTensorDescriptor_t dyDesc,
    const void             *dy,
    const void             *beta,
    const cudnnTensorDescriptor_t dxDesc,
    void                  *dx)

```

This routine computes the gradient of the softmax function.

 In-place operation is allowed for this routine; i.e., `dy` and `dx` pointers may be equal. However, this requires `dyDesc` and `dxDesc` descriptors to be identical (particularly, the strides of the input and output must match for in-place operation to be allowed).

 All tensor formats are supported for all modes and algorithms with 4 and 5D tensors. Performance is expected to be highest with `NCHW fully-packed` tensors. For more than 5 dimensions tensors must be packed in their spatial dimensions

Parameters

**handle**

*Input.* Handle to a previously created cuDNN context.

**algorithm**

*Input.* Enumerant to specify the softmax algorithm.

**mode**

*Input.* Enumerant to specify the softmax mode.

**alpha, beta**

*Input.* Pointers to scaling factors (in host memory) used to blend the computation result with prior value in the output layer as follows:  $\text{dstValue} = \text{alpha}[0] * \text{result} + \text{beta}[0] * \text{priorDstValue}$ . [Please refer to this section for additional details.](#)

**yDesc**

*Input.* Handle to the previously initialized input tensor descriptor.

**y**

*Input.* Data pointer to GPU memory associated with the tensor descriptor **yDesc**.

**dyDesc**

*Input.* Handle to the previously initialized input differential tensor descriptor.

**dy**

*Input.* Data pointer to GPU memory associated with the tensor descriptor **dyData**.

**dxDesc**

*Input.* Handle to the previously initialized output differential tensor descriptor.

**dx**

*Output.* Data pointer to GPU memory associated with the output tensor descriptor **dxDesc**.

The possible error values returned by this function and their meanings are listed below.

**Returns****CUDNN\_STATUS\_SUCCESS**

The function launched successfully.

**CUDNN\_STATUS\_NOT\_SUPPORTED**

The function does not support the provided configuration.

**CUDNN\_STATUS\_BAD\_PARAM**

At least one of the following conditions are met:

- ▶ The dimensions **n**, **c**, **h**, **w** of the **yDesc**, **dyDesc** and **dxDesc** tensors differ.
- ▶ The strides **nStride**, **cStride**, **hStride**, **wStride** of the **yDesc** and **dyDesc** tensors differ.
- ▶ The **datatype** of the three tensors differs.

**CUDNN\_STATUS\_EXECUTION\_FAILED**

The function failed to launch on the GPU.



## 4.214. cudnnSoftmaxForward

```

cudnnStatus_t cudnnSoftmaxForward(
    cudnnHandle_t          handle,
    cudnnSoftmaxAlgorithm_t algorithm,
    cudnnSoftmaxMode_t    mode,
    const void             *alpha,
    const cudnnTensorDescriptor_t xDesc,
    const void             *x,
    const void             *beta,
    const cudnnTensorDescriptor_t yDesc,
    void                   *y)

```

This routine computes the softmax function.



All tensor formats are supported for all modes and algorithms with 4 and 5D tensors. Performance is expected to be highest with **NCHW fully-packed** tensors. For more than 5 dimensions tensors must be packed in their spatial dimensions

### Parameters

#### handle

*Input.* Handle to a previously created cuDNN context.

#### algorithm

*Input.* Enumerant to specify the softmax algorithm.

#### mode

*Input.* Enumerant to specify the softmax mode.

#### alpha, beta

*Input.* Pointers to scaling factors (in host memory) used to blend the computation result with prior value in the output layer as follows:  $\text{dstValue} = \text{alpha}[0] * \text{result} + \text{beta}[0] * \text{priorDstValue}$ . [Please refer to this section for additional details.](#)

#### xDesc

*Input.* Handle to the previously initialized input tensor descriptor.

#### x

*Input.* Data pointer to GPU memory associated with the tensor descriptor **xDesc**.

#### yDesc

*Input.* Handle to the previously initialized output tensor descriptor.

#### y

*Output.* Data pointer to GPU memory associated with the output tensor descriptor **yDesc**.

The possible error values returned by this function and their meanings are listed below.

### Returns

**CUDNN\_STATUS\_SUCCESS**

The function launched successfully.

**CUDNN\_STATUS\_NOT\_SUPPORTED**

The function does not support the provided configuration.

**CUDNN\_STATUS\_BAD\_PARAM**

At least one of the following conditions are met:

- ▶ The dimensions **n, c, h, w** of the input tensor and output tensors differ.
- ▶ The **datatype** of the input tensor and output tensors differ.
- ▶ The parameters **algorithm** or **mode** have an invalid enumerant value.

**CUDNN\_STATUS\_EXECUTION\_FAILED**

The function failed to launch on the GPU.

## 4.215. cudnnSpatialTfGridGeneratorBackward

```

cudnnStatus_t cudnnSpatialTfGridGeneratorBackward(
    cudnnHandle_t          handle,
    const cudnnSpatialTransformerDescriptor_t stDesc,
    const void             *dgrid,
    void                  *dtheta)

```

This function computes the gradient of a grid generation operation.



Only 2d transformation is supported.

### Parameters

#### handle

*Input.* Handle to a previously created cuDNN context.

#### stDesc

*Input.* Previously created spatial transformer descriptor object.

#### dgrid

*Input.* Data pointer to GPU memory contains the input differential data.

#### dtheta

*Output.* Data pointer to GPU memory contains the output differential data.

The possible error values returned by this function and their meanings are listed below.

### Returns

**CUDNN\_STATUS\_SUCCESS**

The call was successful.

**CUDNN\_STATUS\_BAD\_PARAM**

At least one of the following conditions are met:

- ▶ **handle** is NULL.
- ▶ One of the parameters **dgrid**, **dtheta** is NULL.

**CUDNN\_STATUS\_NOT\_SUPPORTED**

The function does not support the provided configuration. See the following for some examples of non-supported configurations:

- ▶ The dimension of transformed tensor specified in **stDesc** > 4.

**CUDNN\_STATUS\_EXECUTION\_FAILED**

The function failed to launch on the GPU.

## 4.216. cudnnSpatialTfGridGeneratorForward

```

cudnnStatus_t cudnnSpatialTfGridGeneratorForward(
    cudnnHandle_t          handle,
    const cudnnSpatialTransformerDescriptor_t stDesc,
    const void             *theta,
    void                  *grid)

```

This function generates a grid of coordinates in the input tensor corresponding to each pixel from the output tensor.



Only 2d transformation is supported.

**Parameters****handle**

*Input.* Handle to a previously created cuDNN context.

**stDesc**

*Input.* Previously created spatial transformer descriptor object.

**theta**

*Input.* Affine transformation matrix. It should be of size  $n*2*3$  for a 2d transformation, where  $n$  is the number of images specified in **stDesc**.

**grid**

*Output.* A grid of coordinates. It is of size  $n*h*w*2$  for a 2d transformation, where  $n$ ,  $h$ ,  $w$  is specified in **stDesc**. In the 4th dimension, the first coordinate is  $x$ , and the second coordinate is  $y$ .

The possible error values returned by this function and their meanings are listed below.

**Returns****CUDNN\_STATUS\_SUCCESS**

The call was successful.

**CUDNN\_STATUS\_BAD\_PARAM**

At least one of the following conditions are met:

- ▶ **handle** is NULL.
- ▶ One of the parameters **grid**, **theta** is NULL.

#### CUDNN\_STATUS\_NOT\_SUPPORTED

The function does not support the provided configuration. See the following for some examples of non-supported configurations:

- ▶ The dimension of transformed tensor specified in **stDesc** > 4.

#### CUDNN\_STATUS\_EXECUTION\_FAILED

The function failed to launch on the GPU.

## 4.217. cudnnSpatialTfSamplerBackward

```

cudnnStatus_t cudnnSpatialTfSamplerBackward(
    cudnnHandle_t             handle,
    const cudnnSpatialTransformerDescriptor_t stDesc,
    const void                *alpha,
    const cudnnTensorDescriptor_t xDesc,
    const void                *x,
    const void                *beta,
    const cudnnTensorDescriptor_t dxDesc,
    void                      *dx,
    const void                *alphaDgrid,
    const cudnnTensorDescriptor_t dyDesc,
    const void                *dy,
    const void                *grid,
    const void                *betaDgrid,
    void                      *dgrid)

```

This function computes the gradient of a sampling operation.



Only 2d transformation is supported.

### Parameters

#### handle

*Input.* Handle to a previously created cuDNN context.

#### stDesc

*Input.* Previously created spatial transformer descriptor object.

#### alpha,beta

*Input.* Pointers to scaling factors (in host memory) used to blend the source value with prior value in the destination tensor as follows:  $\text{dstValue} = \text{alpha}[0] * \text{srcValue} + \text{beta}[0] * \text{priorDstValue}$ . [Please refer to this section for additional details.](#)

#### xDesc

*Input.* Handle to the previously initialized input tensor descriptor.

#### x

*Input.* Data pointer to GPU memory associated with the tensor descriptor **xDesc**.

**dxDesc**

*Input.* Handle to the previously initialized output differential tensor descriptor.

**dx**

*Output.* Data pointer to GPU memory associated with the output tensor descriptor **dxDesc**.

**alphaDgrid,betaDgrid**

*Input.* Pointers to scaling factors (in host memory) used to blend the gradient outputs dgrid with prior value in the destination pointer as follows:  $dstValue = alpha[0]*srcValue + beta[0]*priorDstValue$ . [Please refer to this section for additional details.](#)

**dyDesc**

*Input.* Handle to the previously initialized input differential tensor descriptor.

**dy**

*Input.* Data pointer to GPU memory associated with the tensor descriptor **dyDesc**.

**grid**

*Input.* A grid of coordinates generated by **cudaSpatialTfGridGeneratorForward**.

**dgrid**

*Output.* Data pointer to GPU memory contains the output differential data.

The possible error values returned by this function and their meanings are listed below.

**Returns****CUDNN\_STATUS\_SUCCESS**

The call was successful.

**CUDNN\_STATUS\_BAD\_PARAM**

At least one of the following conditions are met:

- ▶ **handle** is NULL.
- ▶ One of the parameters **x, dx, y, dy, grid, dgrid** is NULL.
- ▶ The dimension of **dy** differs from those specified in **stDesc**

**CUDNN\_STATUS\_NOT\_SUPPORTED**

The function does not support the provided configuration. See the following for some examples of non-supported configurations:

- ▶ The dimension of transformed tensor > 4.

**CUDNN\_STATUS\_EXECUTION\_FAILED**

The function failed to launch on the GPU.

## 4.218. cudnnSpatialTfSamplerForward

```

cudnnStatus_t cudnnSpatialTfSamplerForward(
    cudnnHandle_t          handle,
    const cudnnSpatialTransformerDescriptor_t stDesc,
    const void            *alpha,
    const cudnnTensorDescriptor_t xDesc,
    const void            *x,
    const void            *grid,
    const void            *beta,
    cudnnTensorDescriptor_t yDesc,
    void                  *y)

```

This function performs a sampler operation and generates the output tensor using the grid given by the grid generator.



Only 2d transformation is supported.

### Parameters

#### handle

*Input.* Handle to a previously created cuDNN context.

#### stDesc

*Input.* Previously created spatial transformer descriptor object.

#### alpha,beta

*Input.* Pointers to scaling factors (in host memory) used to blend the source value with prior value in the destination tensor as follows:  $\text{dstValue} = \text{alpha}[0] * \text{srcValue} + \text{beta}[0] * \text{priorDstValue}$ . [Please refer to this section for additional details.](#)

#### xDesc

*Input.* Handle to the previously initialized input tensor descriptor.

#### x

*Input.* Data pointer to GPU memory associated with the tensor descriptor **xDesc**.

#### grid

*Input.* A grid of coordinates generated by **cudnnSpatialTfGridGeneratorForward**.

#### yDesc

*Input.* Handle to the previously initialized output tensor descriptor.

#### y

*Output.* Data pointer to GPU memory associated with the output tensor descriptor **yDesc**.

The possible error values returned by this function and their meanings are listed below.

### Returns

**CUDNN\_STATUS\_SUCCESS**

The call was successful.

**CUDNN\_STATUS\_BAD\_PARAM**

At least one of the following conditions are met:

- ▶ **handle** is NULL.
- ▶ One of the parameters **x**, **y**, **grid** is NULL.

**CUDNN\_STATUS\_NOT\_SUPPORTED**

The function does not support the provided configuration. See the following for some examples of non-supported configurations:

- ▶ The dimension of transformed tensor > 4.

**CUDNN\_STATUS\_EXECUTION\_FAILED**

The function failed to launch on the GPU.

## 4.219. cudnnTransformTensor

```

cudnnStatus_t cudnnTransformTensor(
    cudnnHandle_t      handle,
    const void         *alpha,
    const cudnnTensorDescriptor_t xDesc,
    const void         *x,
    const void         *beta,
    const cudnnTensorDescriptor_t yDesc,
    void              *y)

```

This function copies the scaled data from one tensor to another tensor with a different layout. Those descriptors need to have the same dimensions but not necessarily the same strides. The input and output tensors must not overlap in any way (i.e., tensors cannot be transformed in place). This function can be used to convert a tensor with an unsupported format to a supported one.

### Parameters

#### **handle**

*Input.* Handle to a previously created cuDNN context.

#### **alpha, beta**

*Input.* Pointers to scaling factors (in host memory) used to blend the source value with prior value in the destination tensor as follows:  $\text{dstValue} = \text{alpha}[0] * \text{srcValue} + \text{beta}[0] * \text{priorDstValue}$ . Refer to this section for additional details.

#### **xDesc**

*Input.* Handle to a previously initialized tensor descriptor. See [cudnnTensorDescriptor\\_t](#).

#### **x**

*Input.* Pointer to data of the tensor described by the **xDesc** descriptor.

**yDesc**

*Input.* Handle to a previously initialized tensor descriptor. See [cudnnTensorDescriptor\\_t](#).

**y**

*Output.* Pointer to data of the tensor described by the **yDesc** descriptor.

The possible error values returned by this function and their meanings are listed below.

**Returns****CUDNN\_STATUS\_SUCCESS**

The function launched successfully.

**CUDNN\_STATUS\_NOT\_SUPPORTED**

The function does not support the provided configuration.

**CUDNN\_STATUS\_BAD\_PARAM**

The dimensions **n**, **c**, **h**, **w** or the **dataType** of the two tensor descriptors are different.

**CUDNN\_STATUS\_EXECUTION\_FAILED**

The function failed to launch on the GPU.

## 4.220. cudnnTransformTensorEx

```
cudnnStatus_t cudnnTransformTensorEx(
    cudnnHandle_t handle,
    const cudnnTensorTransformDescriptor_t transDesc,

    const void *alpha,
    const cudnnTensorDescriptor_t srcDesc,
    const void *srcData,
    const void *beta,
    const cudnnTensorDescriptor_t destDesc,
    void *destData);
```

This function converts the Tensor layouts between different formats. It can be used to convert a Tensor with an unsupported layout format to a Tensor with a supported layout format.

This function copies the scaled data from the input Tensor **srcDesc** to the output Tensor **destDesc** with a different layout. The Tensor descriptors of **srcDesc** and **destDesc** should have the same dimensions but need not have the same strides.

The **srcDesc** and **destDesc** Tensors must not overlap in any way (i.e., Tensors cannot be transformed in place).



When performing a folding transform or a zero-padding transform, the scaling factors (**alpha**, **beta**) should be set to (1, 0). However, unfolding transforms support any (**alpha**, **beta**) values. This function is thread safe.

**Parameters:**

Parameter	Input / Output	Description
-----------	----------------	-------------



handle	Input	Handle to a previously created cuDNN context. See <a href="#">cudnnHandle_t</a> .
transDesc	Input	A descriptor containing the details of the requested Tensor transformation. See <a href="#">cudnnTensorTransformDescriptor_t</a> .
alpha, beta	Input	Pointers, in the host memory, to the scaling factors used to scale the data in the input Tensor <code>srcDesc</code> .  Beta is used to scale the destination tensor, while alpha is used to scale the source tensor. See <a href="#">Scaling Parameters</a> .  The beta scaling value is not honored in the folding and zero-padding cases. Unfolding supports any <code>(alpha, beta)</code> .
srcDesc, destDesc	Input	Handles to the previously initialed Tensor descriptors. <code>srcDesc</code> and <code>destDesc</code> must not overlap. See <a href="#">cudnnTensorDescriptor_t</a> .
srcData, destData	Input	Pointers, in the host memory, to the data of the Tensor described by <code>srcDesc</code> and <code>destData</code> respectively.

**Returns:**

Return Value	Description
CUDNN_STATUS_SUCCESS	The function was launched successfully.
CUDNN_STATUS_BAD_PARAM	A parameter is uninitialized, or initialized incorrectly, or the number of dimensions is different between <code>srcDesc</code> and <code>destDesc</code> .
CUDNN_STATUS_NOT_SUPPORTED	Function does not support the provided configuration. Also, in the folding and padding paths, any value other than A=1 and B=0 will result in a CUDNN_STATUS_NOT_SUPPORTED.
CUDNN_STATUS_EXECUTION_FAILED	Function failed to launch on the GPU.

# Chapter 5.

## ACKNOWLEDGMENTS

Some of the cuDNN library routines were derived from code developed by others and are subject to the following:

### 5.1. University of Tennessee

```
Copyright (c) 2010 The University of Tennessee.
```

```
All rights reserved.
```

```
Redistribution and use in source and binary forms, with or without  
modification, are permitted provided that the following conditions are  
met:
```

- \* Redistributions of source code must retain the above copyright notice, this list of conditions and the following disclaimer.
- \* Redistributions in binary form must reproduce the above copyright notice, this list of conditions and the following disclaimer listed in this license in the documentation and/or other materials provided with the distribution.
- \* Neither the name of the copyright holders nor the names of its contributors may be used to endorse or promote products derived from this software without specific prior written permission.

```
THIS SOFTWARE IS PROVIDED BY THE COPYRIGHT HOLDERS AND CONTRIBUTORS  
"AS IS" AND ANY EXPRESS OR IMPLIED WARRANTIES, INCLUDING, BUT NOT  
LIMITED TO, THE IMPLIED WARRANTIES OF MERCHANTABILITY AND FITNESS FOR  
A PARTICULAR PURPOSE ARE DISCLAIMED. IN NO EVENT SHALL THE COPYRIGHT  
OWNER OR CONTRIBUTORS BE LIABLE FOR ANY DIRECT, INDIRECT, INCIDENTAL,  
SPECIAL, EXEMPLARY, OR CONSEQUENTIAL DAMAGES (INCLUDING, BUT NOT  
LIMITED TO, PROCUREMENT OF SUBSTITUTE GOODS OR SERVICES; LOSS OF USE,  
DATA, OR PROFITS; OR BUSINESS INTERRUPTION) HOWEVER CAUSED AND ON ANY  
THEORY OF LIABILITY, WHETHER IN CONTRACT, STRICT LIABILITY, OR TORT  
(INCLUDING NEGLIGENCE OR OTHERWISE) ARISING IN ANY WAY OUT OF THE USE  
OF THIS SOFTWARE, EVEN IF ADVISED OF THE POSSIBILITY OF SUCH DAMAGE.
```

### 5.2. University of California, Berkeley

```
COPYRIGHT
```

```
All contributions by the University of California:  
Copyright (c) 2014, The Regents of the University of California (Regents)
```

All rights reserved.

All other contributions:  
 Copyright (c) 2014, the respective contributors  
 All rights reserved.

Caffe uses a shared copyright model: each contributor holds copyright over their contributions to Caffe. The project versioning records all such contribution and copyright details. If a contributor wants to further mark their specific copyright on a particular contribution, they should indicate their copyright solely in the commit message of the change when it is committed.

#### LICENSE

Redistribution and use in source and binary forms, with or without modification, are permitted provided that the following conditions are met:

1. Redistributions of source code must retain the above copyright notice, this list of conditions and the following disclaimer.
2. Redistributions in binary form must reproduce the above copyright notice, this list of conditions and the following disclaimer in the documentation and/or other materials provided with the distribution.

THIS SOFTWARE IS PROVIDED BY THE COPYRIGHT HOLDERS AND CONTRIBUTORS "AS IS" AND ANY EXPRESS OR IMPLIED WARRANTIES, INCLUDING, BUT NOT LIMITED TO, THE IMPLIED WARRANTIES OF MERCHANTABILITY AND FITNESS FOR A PARTICULAR PURPOSE ARE DISCLAIMED. IN NO EVENT SHALL THE COPYRIGHT OWNER OR CONTRIBUTORS BE LIABLE FOR ANY DIRECT, INDIRECT, INCIDENTAL, SPECIAL, EXEMPLARY, OR CONSEQUENTIAL DAMAGES (INCLUDING, BUT NOT LIMITED TO, PROCUREMENT OF SUBSTITUTE GOODS OR SERVICES; LOSS OF USE, DATA, OR PROFITS; OR BUSINESS INTERRUPTION) HOWEVER CAUSED AND ON ANY THEORY OF LIABILITY, WHETHER IN CONTRACT, STRICT LIABILITY, OR TORT (INCLUDING NEGLIGENCE OR OTHERWISE) ARISING IN ANY WAY OUT OF THE USE OF THIS SOFTWARE, EVEN IF ADVISED OF THE POSSIBILITY OF SUCH DAMAGE.

#### CONTRIBUTION AGREEMENT

By contributing to the BVLC/caffe repository through pull-request, comment, or otherwise, the contributor releases their content to the license and copyright terms herein.

## 5.3. Facebook AI Research, New York

Copyright (c) 2014, Facebook, Inc. All rights reserved.

Redistribution and use in source and binary forms, with or without modification, are permitted provided that the following conditions are met:

- \* Redistributions of source code must retain the above copyright notice, this list of conditions and the following disclaimer.
- \* Redistributions in binary form must reproduce the above copyright notice, this list of conditions and the following disclaimer in the documentation and/or other materials provided with the distribution.
- \* Neither the name Facebook nor the names of its contributors may be used to endorse or promote products derived from this software without specific prior written permission.

THIS SOFTWARE IS PROVIDED BY THE COPYRIGHT HOLDERS AND CONTRIBUTORS "AS IS" AND ANY EXPRESS OR IMPLIED WARRANTIES, INCLUDING, BUT NOT LIMITED TO, THE IMPLIED WARRANTIES OF MERCHANTABILITY AND FITNESS FOR A PARTICULAR PURPOSE ARE DISCLAIMED. IN NO EVENT SHALL THE COPYRIGHT HOLDER OR CONTRIBUTORS BE LIABLE FOR ANY DIRECT, INDIRECT, INCIDENTAL, SPECIAL, EXEMPLARY, OR CONSEQUENTIAL DAMAGES

(INCLUDING, BUT NOT LIMITED TO, PROCUREMENT OF SUBSTITUTE GOODS OR SERVICES; LOSS OF USE, DATA, OR PROFITS; OR BUSINESS INTERRUPTION) HOWEVER CAUSED AND ON ANY THEORY OF LIABILITY, WHETHER IN CONTRACT, STRICT LIABILITY, OR TORT (INCLUDING NEGLIGENCE OR OTHERWISE) ARISING IN ANY WAY OUT OF THE USE OF THIS SOFTWARE, EVEN IF ADVISED OF THE POSSIBILITY OF SUCH DAMAGE.

### Additional Grant of Patent Rights

"Software" means fbcunn software distributed by Facebook, Inc.

Facebook hereby grants you a perpetual, worldwide, royalty-free, non-exclusive, irrevocable (subject to the termination provision below) license under any rights in any patent claims owned by Facebook, to make, have made, use, sell, offer to sell, import, and otherwise transfer the Software. For avoidance of doubt, no license is granted under Facebook's rights in any patent claims that are infringed by (i) modifications to the Software made by you or a third party, or (ii) the Software in combination with any software or other technology provided by you or a third party.

The license granted hereunder will terminate, automatically and without notice, for anyone that makes any claim (including by filing any lawsuit, assertion or other action) alleging (a) direct, indirect, or contributory infringement or inducement to infringe any patent: (i) by Facebook or any of its subsidiaries or affiliates, whether or not such claim is related to the Software, (ii) by any party if such claim arises in whole or in part from any software, product or service of Facebook or any of its subsidiaries or affiliates, whether or not such claim is related to the Software, or (iii) by any party relating to the Software; or (b) that any right in any patent claim of Facebook is invalid or unenforceable.

## Notice

THE INFORMATION IN THIS GUIDE AND ALL OTHER INFORMATION CONTAINED IN NVIDIA DOCUMENTATION REFERENCED IN THIS GUIDE IS PROVIDED “AS IS.” NVIDIA MAKES NO WARRANTIES, EXPRESSED, IMPLIED, STATUTORY, OR OTHERWISE WITH RESPECT TO THE INFORMATION FOR THE PRODUCT, AND EXPRESSLY DISCLAIMS ALL IMPLIED WARRANTIES OF NONINFRINGEMENT, MERCHANTABILITY, AND FITNESS FOR A PARTICULAR PURPOSE. Notwithstanding any damages that customer might incur for any reason whatsoever, NVIDIA’s aggregate and cumulative liability towards customer for the product described in this guide shall be limited in accordance with the NVIDIA terms and conditions of sale for the product.

THE NVIDIA PRODUCT DESCRIBED IN THIS GUIDE IS NOT FAULT TOLERANT AND IS NOT DESIGNED, MANUFACTURED OR INTENDED FOR USE IN CONNECTION WITH THE DESIGN, CONSTRUCTION, MAINTENANCE, AND/OR OPERATION OF ANY SYSTEM WHERE THE USE OR A FAILURE OF SUCH SYSTEM COULD RESULT IN A SITUATION THAT THREATENS THE SAFETY OF HUMAN LIFE OR SEVERE PHYSICAL HARM OR PROPERTY DAMAGE (INCLUDING, FOR EXAMPLE, USE IN CONNECTION WITH ANY NUCLEAR, AVIONICS, LIFE SUPPORT OR OTHER LIFE CRITICAL APPLICATION). NVIDIA EXPRESSLY DISCLAIMS ANY EXPRESS OR IMPLIED WARRANTY OF FITNESS FOR SUCH HIGH RISK USES. NVIDIA SHALL NOT BE LIABLE TO CUSTOMER OR ANY THIRD PARTY, IN WHOLE OR IN PART, FOR ANY CLAIMS OR DAMAGES ARISING FROM SUCH HIGH RISK USES.

NVIDIA makes no representation or warranty that the product described in this guide will be suitable for any specified use without further testing or modification. Testing of all parameters of each product is not necessarily performed by NVIDIA. It is customer’s sole responsibility to ensure the product is suitable and fit for the application planned by customer and to do the necessary testing for the application in order to avoid a default of the application or the product. Weaknesses in customer’s product designs may affect the quality and reliability of the NVIDIA product and may result in additional or different conditions and/or requirements beyond those contained in this guide. NVIDIA does not accept any liability related to any default, damage, costs or problem which may be based on or attributable to: (i) the use of the NVIDIA product in any manner that is contrary to this guide, or (ii) customer product designs.

Other than the right for customer to use the information in this guide with the product, no other license, either expressed or implied, is hereby granted by NVIDIA under this guide. Reproduction of information in this guide is permissible only if reproduction is approved by NVIDIA in writing, is reproduced without alteration, and is accompanied by all associated conditions, limitations, and notices.

## Trademarks

NVIDIA, the NVIDIA logo, and cuBLAS, CUDA, cuDNN, cuFFT, cuSPARSE, DALI, DIGITS, DGX, DGX-1, Jetson, Kepler, NVIDIA Maxwell, NCCL, NVLink, Pascal, Tegra, TensorRT, and Tesla are trademarks and/or registered trademarks of NVIDIA Corporation in the United States and other countries. Other company and product names may be trademarks of the respective companies with which they are associated.

## Copyright

© 2019 NVIDIA Corporation. All rights reserved.