



NVIDIA UFM Enterprise Appliance Gen 3.0 (NDR) Hardware User Manual

Table of Contents

About This Document	4
Relevant Models	4
Intended Audience	4
Technical Support.....	4
Related Documentation	5
Overview	6
Hardware Overview	7
Front Panel of UFM Enterprise Appliance	7
Right Control Panel View	8
Left Control Panel View.....	8
SSD LED Indicators	10
Rear Panel of UFM Enterprise Appliance	11
DB9 Serial Port	12
RJ-45 Port	12
RJ-45 Management Ports.....	13
ConnectX-7 OSFP Ports	13
RJ-45 Ethernet Connector for Remote Management	13
USB Interface	14
PSU Status Indicators.....	14
NIC Activity LED Indicators	15
Airflow	16
Mechanical Installation	17
Package Contents	17
Installing Appliance in Rack	18
Connecting UFM Enterprise Appliance to Network/Fabric.....	19
Grounding Appliance	20
Power Connections and Initial Power On	20
Replacing 3.5" Drive	22
Battery Replacement	23
Approved Cables	23
Appliance Shut Down Procedure.....	23
Disassembly of Appliance from Rack.....	24

Removing Battery	24
Disposal.....	24
Configuring the Appliance	25
Troubleshooting	26
Technical Specifications	28
Regulatory Label (Example)	29
Field Replaceable Units.....	30
Appendix - Installation Safety Warnings.....	31
Switch Safety Warnings (English)	31
Taiwan RoHS Declaration - Switch Systems	33
Taiwan RoHS Declaration - Gateway Systems.....	34
Taiwan BSMI Class A Statement - Warning to the User!	34
Nordic Countries Notices	34
安裝安全性警告 (Simplified Chinese)	34
China CCC Warning Statement	38
Taiwan RoHS Declaration	39
Taiwan BSMI Class A Statement - Warning to the User!	39
安裝安全性警告 (Traditional Chinese)	39
China CCC Warning Statement	43
Taiwan BSMI Class A Statement - Warning to the User!	44
Avertissements de sécurité pour l'installation (French).....	44
Installation Sicherheitshinweise (German).....	47
Advertencias de seguridad de instalación (Spanish).....	50
Предупреждения по технике безопасности при установке (Russian).....	53
Avertismente privind siguranța la instalare (Romanian)	56
Sigurnosna upozorenja za instaliranje (Croatian).....	59
Avvertenze di sicurezza per l'installazione (Italian)	61
Montaj Güvenlik Uyarıları (Turkish)	64
Japan VCCI Statement	67
(Hebrew) הוראות בטיחות בהתקנה.....	67
Document Revision History	71

About This Document

This document describes the installation and basic use of the NVIDIA® UFM® Enterprise Appliance Gen 3.0 (NDR).

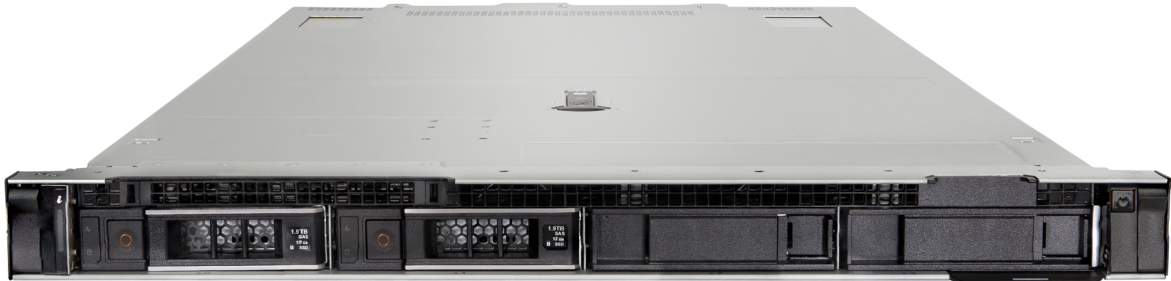

Relevant Models

UFM Appliance version: 3.1

Model	NVIDIA SKU	Legacy OPN
MUA960B	920-9B020-00RA-0D0	MUA9602H-2SRS

Intended Audience

This manual is intended for software and hardware engineers, users and system administrators responsible for fabrics management.

The manual assumes familiarity with the InfiniBand Architecture Specification and with the Ethernet specification.

Technical Support

Customers who purchased NVIDIA products directly from NVIDIA are invited to contact us through the following methods:

- E-mail: enterprisesupport@nvidia.com
- Enterprise Support page: <https://www.nvidia.com/en-us/support/enterprise>

Customers who purchased NVIDIA M-1 Global Support Services, please see your contract for details regarding technical support.

Customers who purchased NVIDIA products through an NVIDIA-approved reseller should first seek assistance through their reseller.

Related Documentation

Document Name	Description
InfiniBand Architecture Specification, Vol. 1, Release 1.2.1	The InfiniBand Architecture Specification that is provided by IBTA
NVIDIA UFM Enterprise Appliance User Manual and Release Notes	This document contains information regarding the use of UFM software, prerequisites, changes and new features, bug fixes, and reports on software known issues

Overview

NVIDIA® UFM® is a powerful platform for managing scale-out computing environments. UFM enables data center operators to monitor and operate the entire fabric efficiently and maximize fabric resource utilization.

UFM eliminates the complexity of fabric management, provides deep visibility into traffic and health, and optimizes application performance.

While other tools are device-oriented and involve manual processes, UFM is an automated and an application-oriented software which bridges the gap between servers, applications, and fabric elements. Thus, it enables administrators to manage and optimize clusters of various sizes.

UFM Enterprise Appliance is offered as a pre-installed network device, suitable for all OS environments. It uses an NVIDIA® ConnectX®-7 NDR single-port adapter card installed on the fabric with minimal effort.

Hardware Overview

The system supports the following:

Qty.	Interface
x1	On/Off button with an integral LED
x1	DB9 Serial Port
x5	RJ-45 Ports
x2	1Gb Ethernet Ports
x2	10Gb Ethernet Connectors
x2	NDR Ports
x2	USB Ports
	Status LEDs
x2	Hot-swap Power Modules
x2	Hot-swap SSD Drawers

Front Panel of UFM Enterprise Appliance

Front Side Interfaces

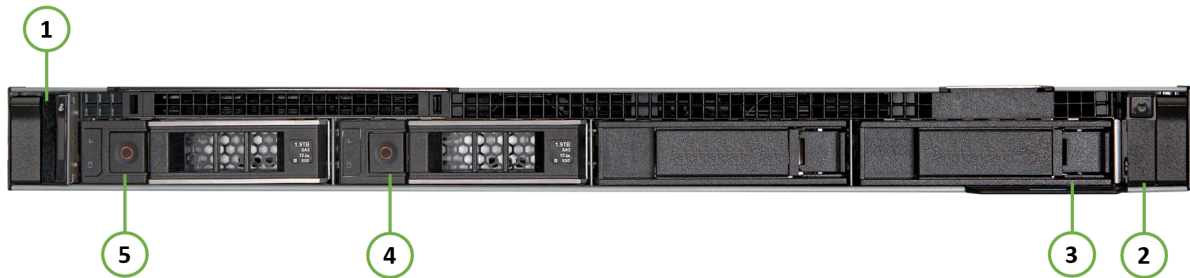

Index	Interface	Description
1	Left control panel	Contains the system health, system ID, and status LED
2	Right control panel	Contains the power button
3	Pull-tab	A slide-out label panel containing system information (e.g., MAC address, serial number, etc.)
4	SSD (FRU)	SSD number 1
5	SSD (FRU)	SSD number 0

Right Control Panel View

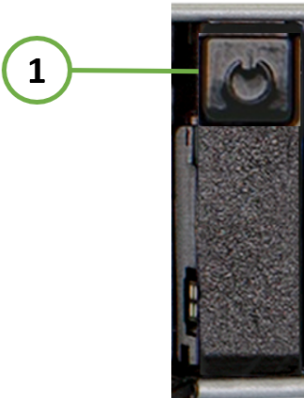

Index	Indicator or Button	Icon	Description
1	Power button		<p>Indicates if the system is powered on or off. Press the power button to manually power on or off the system.</p> <div style="border: 1px solid orange; padding: 5px; margin: 5px 0;"> <p> Press the power button to shut down the ACPI-compliant operating system.</p> </div> <p>For a graceful shutdown of the system, use the relevant CLI command. To force a shutdown of the appliance, hold the button down until the appliance turns off. The LED of the button displays the system's power status.</p>

Left Control Panel View

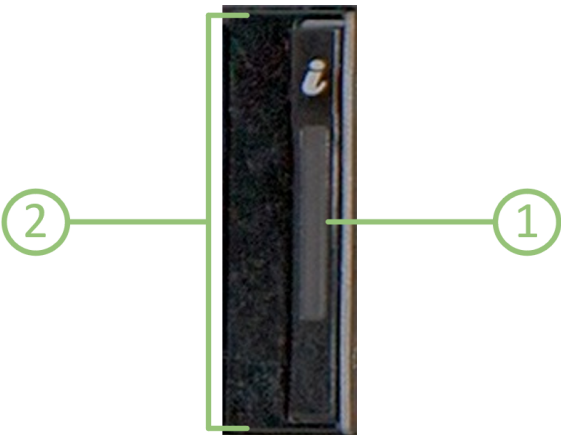



Index	Indicator or Button	Icon	Description
1	System health and system ID indicator		Indicates the system health
2	System status LEDs	N/A	Indicates the status of the system



System Status LEDs

The system status indicators are located on the front left-side panel.

System Status Indicators



Icon	Description	Condition	Corrective Action
	Drive indicator	The indicator turns solid amber if there is a drive error	<ul style="list-style-type: none"> • Check the System Event Log to determine if the drive has an error. • Run the appropriate Online Diagnostics test. Restart the system and run embedded diagnostics (ePSA). • If the drives are configured in a RAID array, restart the system, and enter the host adapter configuration utility program.
	Temperature indicator	The indicator turns solid amber if the system experiences a thermal error (for example, the ambient temperature is out of range or there is a fan failure)	<p>Ensure that none of the following conditions exist:</p> <ul style="list-style-type: none"> • A cooling fan has been removed or has failed. • System cover, air shrouds, or back filler bracket has been removed. • Ambient temperature is too high. • External airflow is obstructed.

Icon	Description	Condition	Corrective Action
	Electrical indicator	The indicator turns solid amber if the system experiences an electrical error (for example, voltage out of range, or a failed power supply unit (PSU) or voltage regulator)	Check the System Event Log or system messages for the specific issue. If it is due to a problem with the PSU, check the LED on the PSU. Reseat the PSU.
	Memory indicator	The indicator turns solid amber if a memory error occurs	Check the System Event Log or system messages for the location of the failed memory. Reseat the memory module.
	PCIe indicator	The indicator turns solid amber if a PCIe card experiences an error	Restart the system. Update any required drivers for the PCIe card. Reinstall the card.

System Health and System ID Indicator Codes

The system health and system ID indicator is located on the left control panel of the system.



System Health and System ID Indicator Code	Condition
Solid blue	Indicates that the system is powered on and healthy, and that system ID mode is not active. Press the system health and system ID button () to switch to system ID mode.
Blinking blue	Indicates that the system ID mode is active. Press the system health and system ID button to switch to system health mode.
Solid amber	Indicates that the system is in fail-safe mode.
Blinking amber	Indicates that the system is experiencing a fault. Check the System Event Log for specific error messages.

SSD LED Indicators

The LEDs on the drive carrier indicate the state of each drive. Each drive carrier has two LEDs: an activity LED (green) and a status LED (bicolor, green/amber). The activity LED blinks whenever the drive is accessed.

SSD Indicators

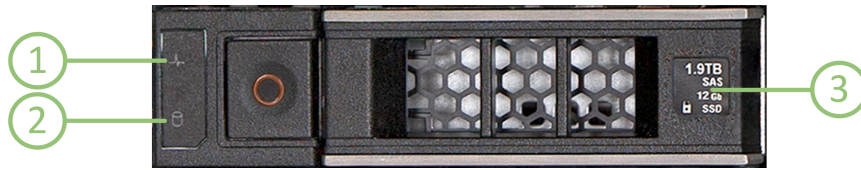

Index	Description
1	Drive status LED indicator
2	Drive activity LED indicator
3	Drive capacity label

The following table lists the drive indicator codes:



Drive Status Indicator Code	Condition
Blinks green twice per second	Indicates that the drive is being identified or preparing for removal
Off	Indicates that the drive is ready for removal <div style="border: 1px solid orange; padding: 5px; margin-top: 10px;"> <p>⚠ The drive status indicator remains off until all drives are initialized after the system is powered on. Drives are not ready for removal during this time.</p> </div>
Blinks green, amber, and then powers off	Indicates that there is an unexpected drive failure
Blinks amber four times per second	Indicates that the drive has failed
Blinks green slowly	Indicates that the drive is rebuilding
Solid green	Indicates that the drive is online
Blinks green for three seconds, amber for three seconds, and then powers off after six seconds	Indicates that the rebuild has stopped

Rear Panel of UFM Enterprise Appliance

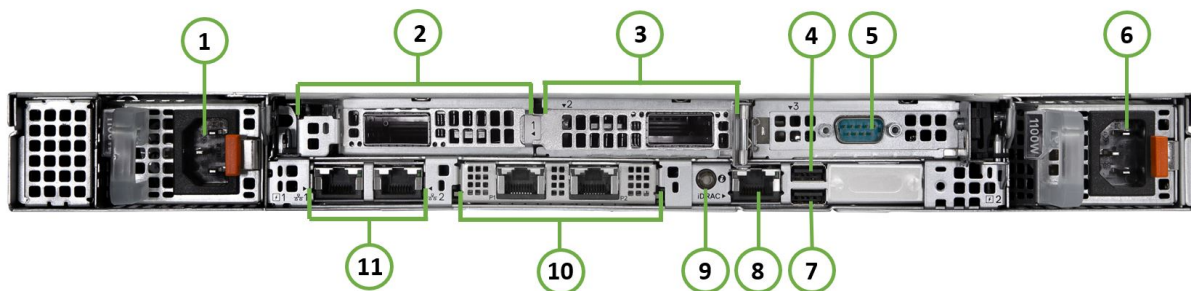
Rear Side Interfaces



Index	Interface	Description
1	Power supply unit (FRU)	PSU 1

Index	Interface	Description
2	PCIe expansion card riser (slot 1)	The expansion card riser enables to connect PCIe expansion cards
3	PCIe expansion card riser (slot 2)	The expansion card riser enables to connect PCIe expansion cards
4	USB 2.0 port	USB 2.0-compliant
5	Com card serial	DB9 serial to motherboard
6	Power supply unit (FRU)	PSU 2
7	USB 3.0 port	USB 3.0-compliant
8	RJ-45 Port	This port is designed for secure local and remote server management control and helps IT administrators deploy, update and monitor the device.
9	System identification button	<p>Press the system ID button:</p> <ul style="list-style-type: none"> To locate a particular system within a rack To turn the system ID on or off To reset the remote management control (press and hold for more than 16 seconds) <div style="border: 1px solid #f96; padding: 5px; margin: 5px 0;"> <p> To reset remote management control using system ID, ensure that the system ID button is enabled in the remote management control setup.</p> </div> <div style="border: 1px solid #f96; padding: 5px; margin: 5px 0;"> <p> If the system stops responding during POST, press and hold the system ID button (for more than 5 seconds) to enter the BIOS progress mode.</p> </div>
10	OCP NIC ports	2x 10GbE Base-T ports
11	NIC ports	2x 1GbE Base-T ports

DB9 Serial Port

The DB9 port, found on the rear side of the appliance (see callout 5 in "[Rear Side Interfaces](#)" figure above), is a serial console DB9 connector. This interface can be connected directly to a laptop via DB9-to-USB cable for first-time configuration or to a Serial-to-Ethernet device. It should be configured to 115200 Bps similar to switches.

RJ-45 Port

The remote management control port is designed for secure local and remote server management and helps IT administrators deploy, update, and monitor the NVIDIA® UFM® Enterprise Appliance.

RJ-45 Management Ports

These four RJ-45 ports (eno8303, eno8403, eno12399np0 and eno12409np1) are found on the rear side of the appliance (see callouts 10 and 11 in "[Rear Side Interfaces](#)" figure above). The eno8303 and the remote management interfaces are pre-configured as DHCP and the initial host name is ubuntu, so their IP addresses can be obtained from the DHCP server. If no DHCP server is available, you have to use a serial cable to connect and configure eno8303 and the remote-management IP addresses with a static IP address.

 Configuring the appliance via the serial port is required only in the case where out-of-the-box DHCP configuration for eno8303 cannot be used. (There is no DHCP server in the management network). The user is then required to use the serial port to configure a static IP on eno8303.

 NIC#1 Ethernet connector gets connected to Ethernet switches. This switch must be configured to 100M/1G auto-negotiation.

ConnectX-7 OSFP Ports

These 2 OSFP ports are found on the rear side of the appliance. See the figure above. They should be connected to an IB switch in the fabric. It is recommended to connect to two different switches for redundancy. The appliance can be connected only to a single IB fabric.

RJ-45 Ethernet Connector for Remote Management

The appliance has several Ethernet management interfaces. The primary management interface is eno8303. An additional interface exists, for connecting to a remote management controller (It usually connects to the same management network as eno8303).

To use out-of-the-box DHCP settings, the default hostname for the appliance (over eno8303) is "ubuntu". The MAC address for eno8303 is available on the pull-tab and can be configured in the DHCP server.

To use the remote management controller with DHCP, the free-range IP allocation must be enabled on the DHCP server. A static IP address for remote management interface can be configured via the Remote Management web application.

 Configuration via a serial port is only required if you want to use a static IP address and not the out-of-the-box DHCP setting for eno8303. Otherwise, an IP is assigned by the DHCP server, and you can log into the CLI over LAN.

 NIC#1 Ethernet connector gets connected to Ethernet switches. This switch must be configured to 100M/1G auto-negotiation.

USB Interface

 The USB interface can be used to update the UFM.

There are two USB connectors. These connectors can be used to install software and/or firmware upgrades using a memory device that has a USB connector. This connector is USB 2.0 compliant. Various upload/download operations are also supported through the USB using the CLI such as:

- UFM configuration fetching/uploading
- UFM license fetching
- UFM upgrade

All USB connectors can be used to perform SW updates or various upload/download operations using the CLI.

PSU Status Indicators

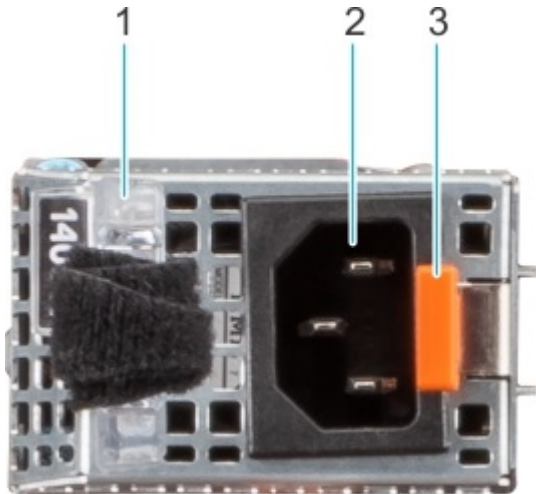

Index	Description
1	AC PSU handle
2	Socket
3	Release latch

Each power supply (PS) unit has a one built-in fan and a single two-color LED on the right side of the PS unit that indicates the internal status of the unit.

The following table presents the AC PSU status indicator codes:

Power Indicator Codes	Condition
Green	Indicates that a valid power source is connected to the PSU and the PSU is operational
Blinking amber	Indicates an issue with the PSU
Not powered on	Indicates that the power is not connected to the PSU

Power Indicator Codes	Condition
Blinking green	<p>Indicates that the firmware of the PSU is being updated</p> <div style="border: 1px solid red; padding: 5px;"> <p>⚠ Do not disconnect the power cord or unplug the PSU when updating firmware. If firmware update is interrupted, the PSUs will not function.</p> </div>
Blinking green and powers off	<p>When hot-plugging a PSU, it blinks green five times at a rate of 4 Hz and powers off. This indicates a PSU mismatch due to efficiency, feature set, health status, or supported voltage.</p> <div style="border: 1px solid red; padding: 5px;"> <p>⚠ If two PSUs are used, they must be of the same type and have the same maximum output power.</p> </div> <div style="border: 1px solid red; padding: 5px;"> <p>⚠ When correcting a PSU mismatch, replace the PSU with the blinking indicator. Swapping the PSU to make a matched pair can result in an error condition and an unexpected system shutdown. To change from a high output configuration to a low output configuration or vice versa, you must power off the system.</p> </div> <div style="border: 1px solid red; padding: 5px;"> <p>⚠ When two identical PSUs receive different input voltages, they can output different wattage, and trigger a mismatch.</p> </div>

The following table presents the DC PSU status indicator codes:

Power Indicator Codes	Condition
Green	Indicates that a valid power source is connected to the PSU, and the PSU is operational
Blinking amber	Indicates an issue with the PSU
Not powered on	Indicates that the power is not connected to the PSU
Blinking green	When hot-plugging a PSU, it blinks green five times at a rate of 4 Hz and powers off. This indicates a PSU mismatch due to efficiency, feature set, health status, or supported voltage.

NIC Activity LED Indicators

Each NIC on the back of the system has indicators that provide information about the activity and link status. The activity LED indicator indicates if data is flowing through the NIC, and the link LED indicator indicates the speed of the connected network.

NIC Activity LEDs

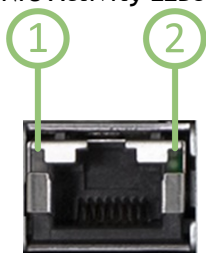

Index	Description
1	Link LED indicator
2	Activity LED indicator

The following table lists the drive indicator codes:

NIC Indicator Code	Condition
Link and activity indicators are off	Indicates that the NIC is not connected to the network
Link indicator is green, and activity indicator is blinking green	Indicates that the NIC is connected to a valid network at its maximum port speed, and data is being sent or received
Link indicator is amber, and activity indicator is blinking green	Indicates that the NIC is connected to a valid network at less than its maximum port speed, and data is being sent or received
Link indicator is green, and activity indicator is off	Indicates that the NIC is connected to a valid network at its maximum port speed, and data is not being sent or received
Link indicator is amber, and activity indicator is off	Indicates that the NIC is connected to a valid network at less than its maximum port speed, and data is not being sent or received
Link indicator is blinking green, and activity is off	Indicates that the NIC identity is enabled through the NIC configuration utility

Airflow

The appliance comes with a single air flow pattern; a front (hard-drive) side to back (power-supply) side.

Mechanical Installation

 Before installing your new appliance, make sure to read and adhere to the safety warnings listed in the "[Installation Safety Warnings](#)" appendix.

UFM Enterprise Appliance accepts input voltages of 100-127 VAC and 200-240 VAC for all possible PS units. The appliance can be rack mounted and is designed for installation in a standard 19" rack. The power (rear) side of the appliance includes two hot-swap power supply modules.

The installer should use a rack capable of supporting the mechanical and environmental characteristics of a fully populated rack.

 The rack mounting holes conform to the EIA-310 standard for 19-inch racks. Take precautions to guarantee proper ventilation in order to maintain good airflow at ambient temperature. Cable routing should not impede the air exhaust from the chassis.

Package Contents

unpack the system and check to make sure that all the parts have been sent. Check this against the parts list below. Check the parts for visible damage that may have occurred during shipping.

The appliance comes packed with the following items:

- 1X - bezel
- 1X - appliance
- 2X - installation rails, one right hand and one left hand
- 2X - power cable per PS unit (type C13-C14)
- 1X - RS232 cable (DB9-to-DB9 harness), 2m
- 1X - Ethernet CAT6A cable (RJ45-to-RJ45), 2m

Installing Appliance in Rack

1. Pull the inner rails out of the rack until they lock into place.



2. Locate the rear rail standoff on each side of the system and lower them into the rear J-slots on the slide assemblies.
3. Rotate the system downward until all the rail standoffs are seated in the J-slots.

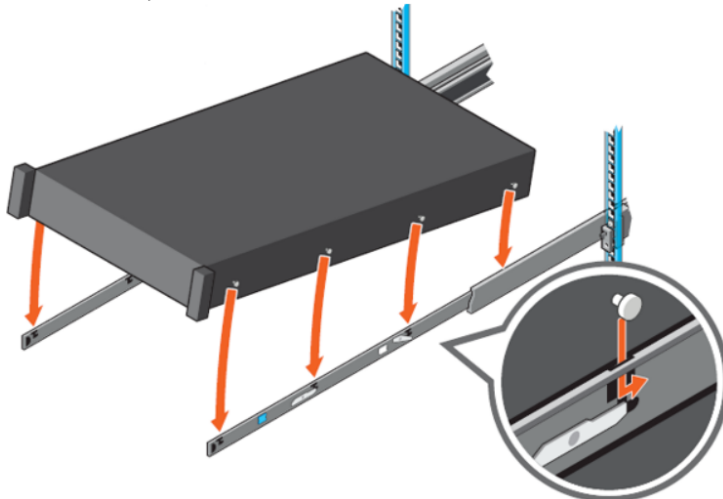

4. Push the system inward until the lock levers click into place.

5. Pull the blue side release lock tabs forward or backward on both rails and slide the system into the rack until the system is in the rack.

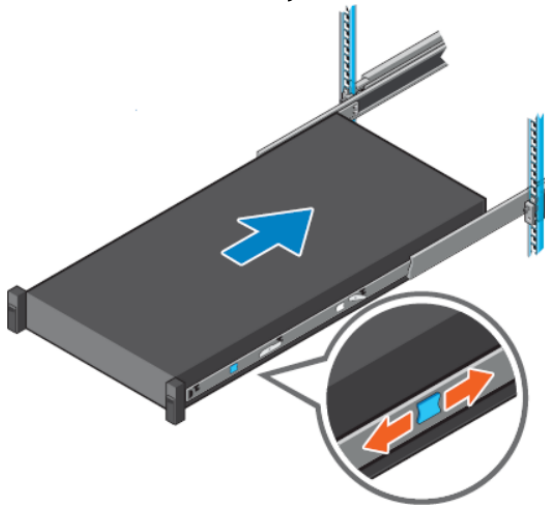

6. Ground the appliance (see "[Grounding the Appliance](#)").
7. Plug in the power cables (see "[Power Connections and Initial Power On](#)").
8. Push the ON/OFF button to start.

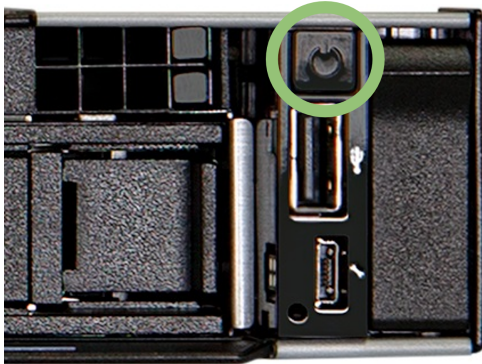

9. Check the Status LEDs and confirm that all of the LEDs show status lights consistent with normal operation.

 Any amber status LEDs are a cause for concern and must be dealt with immediately. It can take up to 5 minutes to boot up, during which time the status LED may indicate red.

Connecting UFM Enterprise Appliance to Network/Fabric

UFM requires both InfiniBand and Ethernet (out-of band management) connectivity where eth0 should be connected to a management network switch and both InfiniBand ports should be connected to InfiniBand switches. They can be connected to the same switch, but NVIDIA recommends connecting to two separate switches, to ensure SM connectivity to the fabric.

Grounding Appliance

Check to determine if your local or national electrical codes require an external ground to all IT components. If so, connect a ground wire to one of the casing screws and connect the other end to a valid ground. If you choose not to use the ground screw, make sure that the rack is properly grounded and that there is a valid ground connection between the chassis of the appliance and the rack. Test the ground using an Ohm meter.

- ⚠ Some national and/or local codes may require IT components to be bonded and externally grounded (not including the power cord ground). You must follow all national and local codes when installing this equipment.

Power Connections and Initial Power On

The UFM Enterprise Appliance ships two power supply units. Each supply has a separate AC receptacle. The appliance accepts input voltages of 100 - 127 VAC and 200 - 240 VAC for all possible PS units. The power cords should be standard 3-wire AC power cords including a safety ground and rated for 15A or higher. The power supplies deliver 750W AC.

- ⚠ After inserting a power cable and turning the appliance on, confirm that the green system status LED light is on.

- ⚠ When turning off the switch, make sure both connector LEDs are off to ensure a powered down status.

- ⚠ Do not hot swap the power supply if your appliance has only one power supply. You must power down the system to replace the power supply unit there is only one PS unit in the appliance.

Extracting and Inserting the Power Supply Unit

Two Power Inlets - Electric Caution Notifications

CAUTION

Risk of electric shock and energy hazard. The two PS units are independent.

Disconnect all power supplies to ensure a powered down state inside of the UFM-

ACHTUNG

Gefahr des elektrischen Schocks. Entfernen des Netzsteckers eines Netzteils spannungsfrei. Um alle Einheiten spannungsfrei zu machen sind die Netzstecker aller Netzteile zu

ATTENTION

Risque de choc et de danger e'lectriques. Le de'branchement d'une seule alimentation stabilise'e ne de'branch uniquement qu'un module "Alimentation Stabilise'e". Pour isoler completement le module en cause, Il faut de'brancher toutes les ali-

⚠ The power supply is only hot-swappable if you have a redundant system with two power supplies installed. If you only have one power supply installed, before removing or replacing the power supply, you must first take the appliance out of service, turn off all peripheral devices connected to the system, turn off the system by pressing the power button, and unplug the AC power cord from the system or wall outlet.

To replace the power supply, follow these steps:

1. Disconnect the power cable from the power outlet and from the PSU you intend to remove.
2. Remove the cable from the strap on the PSU handle.
3. Unlatch and lift the optional cable management arm if it interferes with the PSU removal.
4. Press and hold the PSU latch while sliding the PSU out:

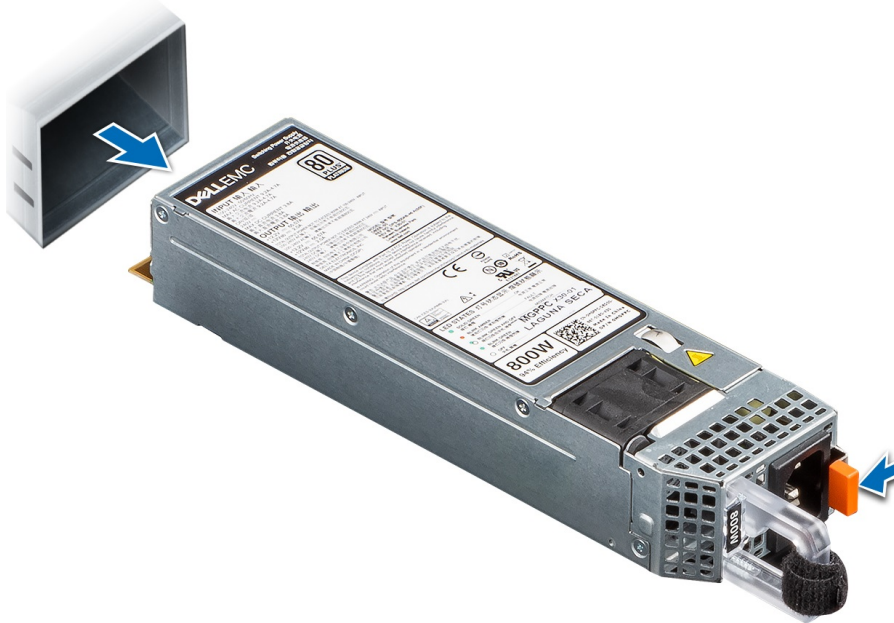

5. Slide the new PSU in:

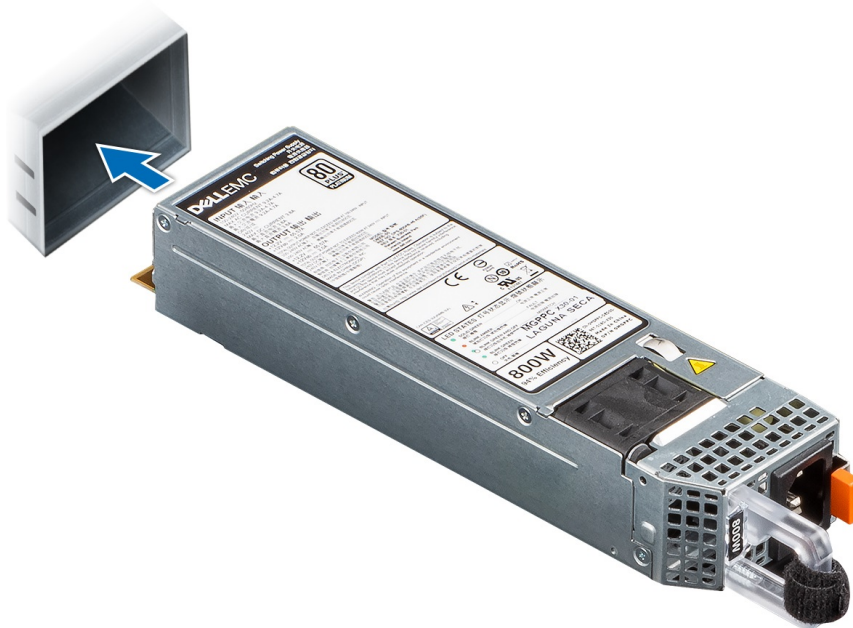

6. If you have unlatched the cable management arm, re-latch it.
7. Connect the power cable to the PSU and plug the cable into a power outlet.

⚠ When connecting the power cable to the PSU, secure the cable to the PSU with the strap.

⚠ When installing, hot swapping, or hot adding a new PSU, wait for 15 seconds for the system to recognize the PSU and determine its status. PSU redundancy may not occur until discovery is complete. The PSU status indicator turns green to indicate that the PSU is functioning properly.

⚠ Do not run the appliance with openings due to missing parts. This may cause overheating due to improper air flow.

Replacing 3.5" Drive

⚠ Never pull out a working hard drive while the appliance is turned on. You can safely pull out a faulty hard drive indicated by a solid amber light.

If one SSD physically fails, the appliance keeps working thanks to RAID mirroring. You can pull out and replace a faulty drive with a new blank SSD, the blank SSD will get synchronized with the other SSD, this takes up to 48 hours but does not interrupt appliance operation.

1. Power down the appliance before removing the SSD
2. Press the release button to open the drive carrier release handle.
3. Holding the drive carrier release handle, slide the drive carrier out of the drive slot.
4. Remove the SSD from its carrier drawer.



5. Hold the release handle and slide the drive carrier into the drive slot.

6. Close the drive carrier release handle to lock the drive in place.



7. Power on the appliance.

⚠ The SW RAID mechanism will identify that a new SSD was inserted and synchronize the data with the second SSD, this process might take up to 48 hours to complete.

Battery Replacement

NVIDIA does not support battery replacement. Customer removal of the UFM cover will void the warranty. Only remove the cover to comply with WEEE directives or to disassemble for environmentally approved disposal.

Approved Cables

For information on the approved cables to use with this device, refer to NVIDIA's [LinkX webpage](#).

Appliance Shut Down Procedure

To shut down the appliance, run the following command:

```
reload halt [noconfirm]
```

⚠ The appliance cannot be restarted remotely!
To restart the appliance, you must physically go to the appliance and unplug and plug in the power cord.

You can also shut down or cold reset the appliance remotely by using the remote management.

Disassembly of Appliance from Rack

To disassemble the appliance from the rack:

1. Shut down the appliance.
2. Unplug and remove all connectors.
3. Unplug all power cords.
4. Remove the ground wire.
5. Unscrew the 2 center bolts from inside the handles.
6. Slide the appliance from the rack.
7. Remove the rail slides from the rack.

Removing Battery

This procedure is only to be used when you are disassembling this appliance before discarding, to comply with regulations regarding disposal of batteries.

1. Remove the cover.
2. Remove the battery and dispose of it according to local and state and federal regulations.

Disposal



According to the WEEE Directive 2002/96/EC, all waste electrical and electronic equipment (EEE) should be collected separately and not disposed of with regular household waste. Dispose of this product and all of its parts in a responsible and environmentally friendly way.

Configuring the Appliance

⚠ It is not recommended to reset the BIOS settings to default values (factory settings). Doing so may impact the functionality of the UFM appliance. The future BIOS version will allow a proper reset of default BIOS settings.

The NVIDIA® UFM® Enterprise Appliance has multiple Ethernet management interfaces. The primary management interface is eno8303. The MAC address for eno8303 is available on the pull tab and can be configured in the DHCP server. To use the remote management controller with DHCP, the free-range IP allocation must be enabled on the DHCP server.

The appliance supports a direct connection via a serial port.

To connect to the appliance:

⚠ Configuration via a serial port is only required if you wish to use a static IP address and not the out-of-the-box DHCP setting for eno8303. Otherwise, an IP will be assigned by the DHCP server, and you will be able to log into the Ubuntu OS.

1. Connect the host PC to the DB9 port of the appliance system using the provided RS232 DB9-to-DB9 cable.

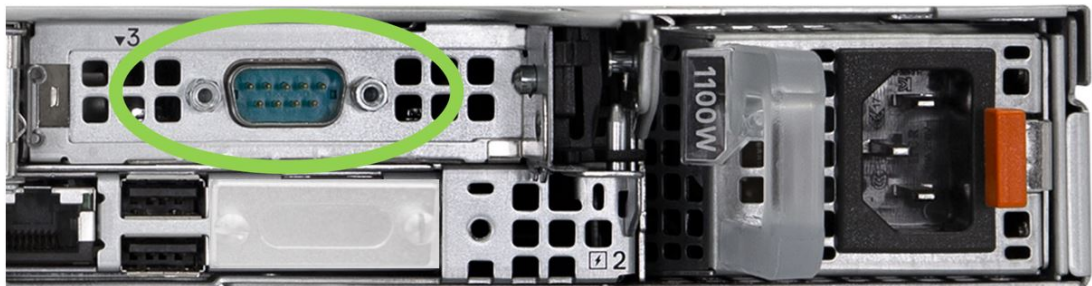

2. Configure a serial terminal program (for example, HyperTerminal, minicom, or Tera Term) on your host PC with the settings described in the table below.

<i>Serial Terminal Program Configuration</i>	
Parameter	Setting
Baud Rate	115200
Data bits	8
Stop bits	1
Parity	None
Flow Control	None

3. Log in (from a serial terminal program) as `root` and use `UFMappliance` as the password.
4. Configure a static IP with Netplan (edit the file `/etc/netplan/01-netcfg.yaml`).

Troubleshooting

As soon as the appliance is plugged in, make sure that the green power LEDs on the PS units are on. See section "[Hardware Overview](#)" on page for the names and locations of the various LEDs.

Troubleshooting Issues and Resolutions	
Issue	Resolution
System Status LED is RED	Unplug the appliance and call your NVIDIA representative.
Power Supply Unit Status LED is not lit or is RED	<ol style="list-style-type: none"> 1. Check that the power cable is plugged into a working outlet. 2. Check that the power cable has a voltage within the range of 100-240 volts AC. 3. Remove and reinstall the power cable. 4. Remove and reinstall the power supply unit.
The Power Button w/Integrated LED for the appliance shuts off	<ol style="list-style-type: none"> 1. Check that there is adequate ventilation. 2. Make sure that there is nothing blocking the front or rear of the chassis and that the fan modules and ventilation holes are not blocked (especially dust over the holes). 3. If you find dust blocking the holes it is recommended to clean the fan unit and remove the dust from the front and rear panels of the appliance using a vacuum cleaner.
The link LED for the Ethernet connector does not come on	<ol style="list-style-type: none"> 1. Check that both ends of the cable are connected. 2. Check that the locks on the ends are secured. 3. Make sure that the latest firmware version is installed on all the HCA cards and the appliance. 4. If media adapters are used, check that all the connections are good, tight, and secure.
The activity LEDs do not come on	Check that UFM has been started.
The appliance is off	Press the Power Button w/Integrated LED, If that does not work: <ol style="list-style-type: none"> 1. Unplug the appliance. 2. Wait 5 minutes. 3. Plug in the appliance and press the Power Button w/ Integrated LED. 4. If the appliance does not come on, check the power supplies. 5. If the appliance comes on, Use the UFM management software to determine the cause of the Shutdown. 6. Check the temperature. 7. Check the Fan status.
Hard drive LED is constant amber	SSD is faulty, replace according to instructions in section " Removing a Hard Disk Drive from a 3.5" Hard Drive Carrier ".
Hard drive LED is blinking amber	RAID is rebuilding, wait for this operation to complete (might take up to 48 hours). Please refer to Section " 3.5 Inch Hard Drive LEDs " and section " Removing a Hard Disk Drive from a 3.5" Hard Drive Carrier " for additional information.

Troubleshooting Issues and Resolutions

Issue	Resolution
The appliance is not working and is unresponsive	Reset the appliance. If resetting the appliance does not work: <ol style="list-style-type: none">1. Unplug the appliance.2. Wait 5 minutes.3. Plug in the appliance and press the Power Button w/ Integrated LED.4. If the appliance does not come on, check the power supplies.5. If the appliance comes on, use the UFM management software to determine the cause of the shutdown.6. If the appliance continues to be unresponsive contact NVIDIA Networking Support.

Technical Specifications

<i>UFM Enterprise Appliance Technical Specification Data</i>		
Physical		
Size	1U: <ul style="list-style-type: none"> • Height - 42.8 mm (1.7 inches) • Width - 482 mm (18.97 inches) • Depth - 809 mm (31.85 inches) - without bezel, 822.84 mm (32.39 inches) - with bezel 	
Weight	17kg	
Mounting	19" Rack mount	
Power		
Input Voltage	1100W power supply module 100-240 V at 50/60 Hz 12-6.3 A	
CPU	2X Intel Xeon Silver 4314	
PSU	80 Plus Titanium 1+1 redundant power supply 1100 W @ 100-240 V	
Maximum	689 W	
Protocol Support		
InfiniBand/Ethernet	Auto-negotiation: <ul style="list-style-type: none"> • X/2X/4X SDR (2.5Gb/s per lane) • DDR (5Gb/s per lane) • QDR (10Gb/s per lane) • FDR10 (10.3125Gb/s per lane) • FDR (14.0625Gb/s per lane) • EDR (25Gb/s per lane) port • HDR (50Gb/s per lane) port • NDR (400Gb/s per lane) Ethernet: 400GAUI-8 C2M, 400GBASE-CR8, 200GAUI-4 C2M, 200GBASE-CR4, 100GAUI-2 C2M, 100GBASE-CR4, 100GBASE-CR2, 100GBASE-CR1, 50GAUI-2 C2M, 50GAUI-1 C2M, 50GBASE-CR, 50GBASE-R2, 40GBASE-CR4, 40GBASE-R2, 25GBASE-R, 10GBASE-R, 10GBASE-CX4, 1000BASE-CX, CAUI-4 C2M, 25GAUI C2M, XLAUI C2M, XLPPI, SFI SGMII Data Rate: SDR	
Data Rate	InfiniBand - SDR/DDR/QDR/FDR/EDR/HDR/NDR Ethernet - 1/10/25/40/50/100/200/400 Gb/s	
Storage		
Hard Drives	2 x 1.92GB SSD 2.5"	
Memory	64 GB RAM	
Environmental		
Temperature	Operating	0-35 °C
	Non-operating	-20-60 °C
Humidity	Operating	10-85% @ 40 °C (non-condensing)
	Non-operating	10-95% @ 40 °C (non-condensing)
Vibration (5 ~500 Hz)	0.25 gr	
Shock	10G (with 11 ms duration, half-sine wave)	
Thermal	Airflow	52.1 CFM
	Maximum heat dissipation	2241.8 BTU/hr

Reliability, Availability and Serviceability Features

**Hot-swappability/
Redundancy**

- Hot-swappable: 1+1 power supplies
- N+N redundant

Regulatory Label (Example)

型号/型號 **Model: MUA960B**



Electrical Rating:

1x/2x 100-240 Vac, 50/60Hz, 7-3A

输入规格/輸入規格

Laite on liitettävä suojakoskettimilla varustettuun pistorasiaan.

Apparatet må tilkoples jordet stikkontakt. Apparaten skall anslutas till jordat uttag.

產品名稱: 伺服器/
产品名称: 服务器

<p style="text-align: center;">CAUTION</p> <p>Risk of electric shock and energy hazard. Disconnecting one power supply disconnects only one power supply module. To isolate the unit completely disconnect all power supplies.</p>	<p style="text-align: center;">ATTENTION</p> <p>Risque de choc et de danger électriques. Le débranchement d'une seule alimentation stabilisée ne débranche uniquement qu'un module "Alimentation Stabilisée". Pour isoler complètement le module on cause, il faut débrancher toutes les alimentations stabilisées.</p>	<p style="text-align: center;">注意安全</p> <p>注意: 此产品可能为两个电源供电, 单电源可以正常工作, 在维修的时候一定要关闭所有电源</p>	<p style="text-align: center;">ACHTUNG</p> <p>Gefahr des elektrischen Schocks. Entfernen des Netzsteckers eines Netz-teils spannungsfrei. Um alle Einheiten spannungs-frei zu machen sind die Netzstecker aller Netzteile zu entfernen.</p>
---	--	---	--

DO NOT REMOVE THE COVER



www.tuv.com
ID 0000100000



**UK
CA**

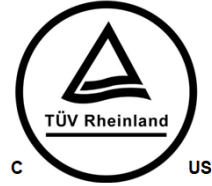

European Regulatory Address:
Mellanox Technologies Denmark ApS.
Ledreborg Alle 130B,
4000 Roskilde, Denmark

UK Regulatory Address:
Mellanox Technologies, UK
37 Broadhurst Gardens,
London NW6 3QT

警告使用者: 這是甲類的資訊產品, 在居住的環境中使用時, 可能會造成射頻干擾, 在這種情況下, 使用者會被要求採取某些適當的對策。

This device complies with part 15 of the FCC rules. Operation is subject to the following two conditions: (1) this device may not cause harmful interference, and (2) this device must accept any interference received, including interference that may cause undesired operation.

警告: 在生活环境中, 该产品工作时可能会造成无线电干扰。

Patented: www.Mellanox.com/page/patents **CAN ICES-3 (A)/ NMB-3(A)** Mellanox Technologies Ltd.

Field Replaceable Units











Ordering Number	Part Description
MUA96-PF	Power Supply w/ PSU Side to Connector side airflow for NVIDIA UFM Gen 3.0 Appliance and MetroX-3 XC 1U Servers
MUA96-SKIT	Rack installation kit for NVIDIA UFM Appliance Gen 3.0 and MetroX-3 XC servers standard depth racks
MUA9602H-SD	NVIDIA UFM Appliance Gen 3.0 Solid-state Drive FRU

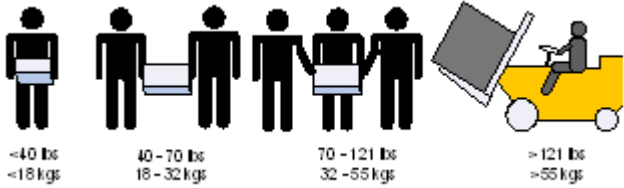











Appendix - Installation Safety Warnings





Safety warnings are provided in multiple languages for your convenience:

 Note that not all warnings may apply to all models.

Switch Safety Warnings (English)

	<p>Installation Instructions Read all installation instructions before connecting the equipment to the power source.</p>
	<p>Bodily Injury Due to Weight Use enough people to lift this product safely.</p> 
	<p>Heavy Equipment This heavy equipment should be moved using a mechanical lift to avoid injuries.</p>
	<p>Risk of Electric Shock!</p> <ul style="list-style-type: none"> • With the fan module removed power pins are accessible within the module cavity. Do not insert tools or body parts into the fan module cavity. • For AC powered switch systems: Disconnecting one power supply only disconnects one module. To isolate the unit completely, all connected power supplies must be disconnected.  <p>In QM97X0/HGX H100 switch systems: for 200-240Vac use only</p>
	<p>Over-temperature This equipment should not be operated in an area with an ambient temperature exceeding the maximum value listed in the product specifications. Moreover, to guarantee proper ventilation, allow at least 8 cm (3 inches) of clearance around the ventilation openings.</p>
	<p>Stacking the Chassis The chassis should not be stacked on any other equipment. If the chassis falls, it can cause bodily injury and equipment damage.</p>
	<p>Redundant Power Supply Connection (OPTIONAL)—Electrical Hazard This product includes a redundant power or a blank in its place. In case of a blank power supply, do not operate the product with the blank cover removed or not securely fastened.</p>
	<p>Double Pole/Neutral Fusing This system has double pole/neutral fusing. Remove all power cords before opening the cover of this product or touching any internal parts.</p>

	<p>Multiple Power Inlets Risk of electric shock and energy hazard. The PSUs are all independent. Disconnect all power supplies to ensure a powered down state inside of the switch platform.</p>
	<p>During Lightning—Electrical Hazard During periods of lightning activity, do not work on the equipment or connect or disconnect cables.</p>
	<p>Copper Cable Connecting/Disconnecting Copper cables are heavy and not flexible, as such they should be carefully attached to or detached from the connectors. Refer to the cable manufacturer for special warnings/instructions.</p>
	<p>Rack Mounting and Servicing When this product is mounted or serviced in a rack, special precautions must be taken to ensure that the system remains stable. In general, the rack should be filled with equipment starting from the bottom to the top.</p>
	<p>Equipment Installation This equipment should be installed, replaced, and/or serviced only by trained and qualified personnel.</p>
	<p>Equipment Disposal Disposal of this equipment should be in accordance to all national laws and regulations.</p>
	<p>Local and National Electrical Codes This equipment should be installed in compliance with local and national electrical codes.</p>
	<p>Installation Codes This device must be installed according to the latest version of the country national electrical codes. For North America, equipment must be installed in accordance to the applicable requirements in the US National Electrical Code and the Canadian Electrical Code.</p>
	<p>Battery Replacement Warning: Replace only with UL Recognized battery, certified for maximum abnormal charging current not less than 4mA. There is a risk of explosion should the battery be replaced with a battery of an incorrect type. Dispose of used batteries according to the instructions.</p>
	<p>UL Listed and CSA Certified Power Supply Cord For North American power connection, select a power supply cord that is UL Listed and CSA Certified, 3 - conductor, [16 AWG], terminated with a molded plug rated at 125 V, [13 A], with a minimum length of 1.5m [six feet] but no longer than 4.5m. For European connection, select a power supply cord that is internationally harmonized and marked “<HAR>”, 3 - conductor, minimum 1.0 mm² wire, rated at 300 V, with a PVC insulated jacket. The cord must have a molded plug rated at 250 V, 10 A.</p>
	<p>Installation Codes This device must be installed according to the latest version of the country's national electrical codes. For North America, equipment must be installed in accordance to the applicable requirements in the US National Electrical Code and the Canadian Electrical Code.</p>
	<p>Interconnection of Units Cables for connecting to the unit RS232 and Ethernet Interfaces must be UL certified type DP-1 or DP-2. (Note: when residing in non LPS circuit.)</p>

	<p>Overcurrent Protection A readily accessible Listed branch circuit overcurrent protective device rated 20 A must be incorporated in the building wiring.</p> <p>Acoustic Level Warning The acoustic level listed in Specifications section represents product noise measured in accordance with ISO 7779 under nominal conditions. The actual noise level can vary depending on the installation conditions, including but not limited to the number of racks in the installation, the overall installation size, rack and other equipment material and noise levels, fan faults, room temperature, room configuration, and employee location in relation to the equipment. The data-center owner should manage effective hearing conservation as per the OSHA standard to protect employees against over and extended exposure to noise.</p>
	<p>Do Not Use the Switch as a Shelf or Work Space Caution: Slide/rail mounted equipment is not to be used as a shelf or a work space. The rails are not intended for sliding the unit away from the rack. It is for permanent installation at final resting place only, not used for service and maintenance.</p>
	<p>WEEE Directive According to the WEEE Directive 2002/96/EC, all waste electrical and electronic equipment (EEE) should be collected separately and not disposed of with regular household waste. Dispose of this product and all of its parts in a responsible and environmentally-friendly way.</p>
	<p>Country of Norway Power Restrictions This unit is intended for connection to a TN power system and an IT power system of Norway only.</p>

Taiwan RoHS Declaration - Switch Systems

設備名稱：伺服器						
單元Unit	限用物質及其化學符號					
	鉛Lead (Pb)	汞Mercury (Hg)	鎘Cadmium (Cd)	六價鉻 Hexavalent chromium (Cr ⁺⁶)	多溴聯苯 Polybrominated biphenyls (PBB)	多溴二苯醚 Polybrominated diphenyl ethers (PBDE)
印刷電路板	—	○	○	○	○	○
金屬外殼	○	○	○	○	○	○
塑膠件	○	○	○	○	○	○
PCB 板電子零件	—	○	○	○	○	○
<p>備考1. “超出0.1 wt %”及“超出0.01 wt %”係指限用物質之百分比含量超出百分比含量基準值。</p> <p>備考2. “○”係指該項限用物質之百分比含量未超出百分比含量基準值。</p> <p>備考3. “—”係指該項限用物質為排除項目。</p>						

Taiwan RoHS Declaration - Gateway Systems

設備名稱： 閘道器						
單元Unit	限用物質及其化學符號					
	鉛Lead (Pb)	汞Mercury (Hg)	鎘Cadmium (Cd)	六價鉻 Hexavalent chromium (Cr ⁺⁶)	多溴聯苯 Polybrominated biphenyls (PBB)	多溴二苯醚 Polybrominated diphenyl ethers (PBDE)
印刷電路板	—	○	○	○	○	○
金屬外殼	○	○	○	○	○	○
塑膠件	○	○	○	○	○	○
PCB 板電子零件	—	○	○	○	○	○

備考1. “超出0.1 wt %”及“超出0.01 wt %”係指限用物質之百分比含量超出百分比含量基準值。

備考2. “○”係指該項限用物質之百分比含量未超出百分比含量基準值。

備考3. “—”係指該項限用物質為排除項目。

Taiwan BSMI Class A Statement - Warning to the User!

警告：為避免電磁干擾，本產品不應安裝或使用於住宅環境。

Nordic Countries Notices

In Finland: "Laite on liitettävä suojakoskettimilla varustettuun pistorasiaan"

In Norway: "Apparatet må tilkoples jordet stikkontakt"

In Sweden: "Apparaten skall anslutas till jordat uttag"

安裝安全性警告 (Simplified Chinese)

 安裝指示

本設備附有備援電源供應器或在適當位置配有空白蓋板。



因重量導致的人身受傷

為了安全起見，請安排足夠的人員以合力抬起本產品。

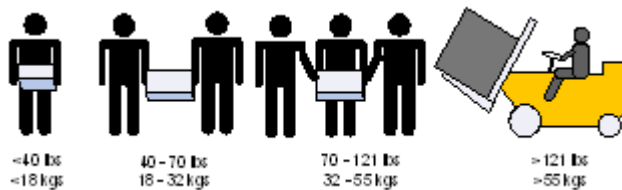

重設備

本設備極重，應使用機械式起重機來搬移，以避免人員受傷。



有觸電的危險

有觸電的危險！拆除風扇模組後，即可接觸到模組空腔內的電源針腳。請勿將工具或機身零件插入到風扇模組空腔內。



溫度過高

本設備不應在超過所建議的最高環境溫度的區域中運作：45°C (113°F)。此外，為了保證氣流的流通正常，請在通風口旁保留至少 8 公分 (3 英吋) 的間距。



堆疊機箱

機箱不應堆疊在任何其他設備上。如果機箱掉落，可能造成人員受傷與設備損壞。



複式電源連接時的電擊危險

本設備附有備援電源供應器或在適當位置配有空白蓋板。如果是電源供應器空白蓋板，在空白蓋板已取下或未牢牢固訂的情況下，請勿操作本產品。



雙極/中性保險絲

本系統具有雙極/中性保險絲。請拔掉所有電源線後，再打開本產品的蓋板或碰觸任何內部零件。



多電源輸入座

電擊與能源危害的危險。所有 PSU 均各自獨立。將所有電源供應器斷電，確保交換器平台內部在電源關閉狀態。



閃電時的電擊危險

在閃電期間，不要使用本設備或連接或拔下纜線。



機架安裝與維修

此產品已安裝在機架中或在機架中維修時，必須採取特定預防措施以確保系統維持穩定。一般您應該將設備從底部到頂端放滿機架。



設備安裝

本設備僅限由經過訓練與/或合格的人員安裝、更換或維修。



設備棄置

棄置本設備應遵照所有國內法規。



當地與國家電氣法規

請遵照當地與國家電氣法規安裝本設備。



安裝法規

請務必遵循最新版的國家電氣法規，安裝本設備。在北美地區，請務必遵循美國國家電工法規和加拿大電工法規中的適用規定，安裝本設備。



更換電池

警告：只能以 UL 認可電池，且取得最大異常充電電流低於 4mA 認證的電池進行更換。
若更換錯誤類型的電池，會有爆炸的危險。
請依據指示棄置廢電池。



UL 列名和 CSA 認證電源線

北美地區在接上電源時，請選用獲得 UL 列名和 CSA 認證、三個導體、[16 AWG] 附成型插頭，額定值為 125 V、[13 A]，長度至少 1.5 公尺 [六英尺]，但不超過 4.5 公尺的電源線。
歐洲地區在接上電源時，請選用國際協調式且標示有 <HAR> 字樣、三個導體、標稱截面至少 1.0 平方公厘，額定值為 300 V，採用 PVC 絕緣的電源線。電源線需有成型插頭，額定值為 250 V, 10 A。



高漏電流

警告：高漏電流；必須執行地線連接，然後再連接電源供應器。



安裝法規

請務必遵循最新版的國家電氣法規，安裝本設備。在北美地區，請務必遵循美國國家電工法規和加拿大電工法規中的適用規定，安裝本設備。



互連設備

連接至 RS232 設備和乙太網路介面的纜線必須是 UL 認證類型 DP-1 或 DP-2。(請注意位於非 LPS 電路時)
過電流保護：準備好使用的列名分支電路過電流保護裝置最大額定值 20 A 必須整合在配線中。



請勿將交換機作為機架與工作空間使用

小心：具有滑軌 / 導軌設備不可用作機架或工作空間。導軌不適用於將設備滑出機架使用。
仅限永久安裝在最後安置區域時使用，不可用於維修和保養。



WEEE 指令

根据 WEEE 指令 2002/96/EC，所有废弃的电气与电子设备 (EEE)，应分开集中，而且不应与一般家庭废弃物一起弃置。请以负责和环保的方式弃置本产品及其所有零件。



挪威国家电源限制

本设备仅限连接至挪威的 TN 电源系统和 IT 电源系统。

China CCC Warning Statement

在维修的时候一定要断开所有电源 (English translation"disconnect all power sources before service")



For non tropical use:

安全 说明 和标 记	汉文	“仅适用于非热带气候条件下安全使用。”
	藏文	《འགོག་སྲོལ་གྱི་གནད་ལ་གཞིགས་ཅིན་པའི་ས་ཁུལ་ལོ་ནན་ཉེན་མེད་བེད་སྤྱོད་བྱས་འཇུག།》
	蒙古文	“ “ ཚ་བའི་ས་ཁུལ་གྱི་གནད་ལ་གཞིགས་ཅིན་པའི་ས་ཁུལ་ལོ་ནན་ཉེན་མེད་བེད་སྤྱོད་བྱས་འཇུག།”
	壮文	Dan hab yungh youq gij dienheiq diuzgen mbouj dwg diegndat haenx ancienz sawjyungh.
	维文	غەيرى ئىسسىق بەلباغ ھاۋا كىلىماتى شارائىتىدىلا بىخەتەر ئىشلەتكىلى بولىدۇ



For altitude 2000 meter and below:

安全 说明 和标 记	汉文	仅适用于海拔2000m以下地区安全使用。
	藏文	《2000m རྒྱུ་ལྡན་གྱི་ས་ཁུལ་ལོ་ནན་ཉེན་མེད་བེད་སྤྱོད་བྱས་འཇུག།》
	蒙古文	“ “ ལྷ་མོ་ཚོའི་ས་ཁུལ་ལོ་ནན་ཉེན་མེད་བེད་སྤྱོད་བྱས་འཇུག།”
	壮文	Dan hab yungh youq gij digih haijbaz 2000m doxroengz haenx ancienz sawjyungh.
	维文	دېڭىز يۈزىدىن 2000 مېتىر تۆۋەن رايونلاردا بىخەتەر ئىشلەتكىلى بولىدۇ

Warning for Class A:

声 明

此为 A 级产品，在生活环境中，该产品可能会造成无线电干扰。在这种
种情况下，可能需要用户对其干扰采取切实可行的措施。

English translation of above statement

This is a Class A product. In a domestic environment this product may cause radio interference, in which case the user may be required to take adequate measures.

Taiwan RoHS Declaration

設備名稱： 伺服器		型號（型式） MUA960 MUA960B				
單元Unit	限用物質及其化學符號					
	鉛Lead (Pb)	汞Mercury (Hg)	鎘Cadmium (Cd)	六價鉻 Hexavalent chromium (Cr ⁺⁶)	多溴聯苯 Polybrominated biphenyls (PBB)	多溴二苯醚 Polybrominated diphenyl ethers (PBDE)
印刷電路板	—	○	○	○	○	○
金屬外殼	○	○	○	○	○	○
塑膠件	○	○	○	○	○	○
PCB 板電子零件	—	○	○	○	○	○

備考1. “超出0.1 wt %”及“超出0.01 wt %”係指限用物質之百分比含量超出百分比含量基準值。

備考2. “○”係指該項限用物質之百分比含量未超出百分比含量基準值。

備考3. “—”係指該項限用物質為排除項目。

Taiwan BSMI Class A Statement - Warning to the User!

警告使用者:

此為甲類資訊技術設備，於居住環境中使用時，可能會造成射頻擾動，在此種情況下，使用者會被要求採取某些適當的對策。

安裝安全性警告 (Traditional Chinese)



安裝指示

本設備附有備援電源供應器或在適當位置配有空白蓋板。



因重量導致的人身受傷

为了安全起见，请安排足够的人员以合力抬起本产品。

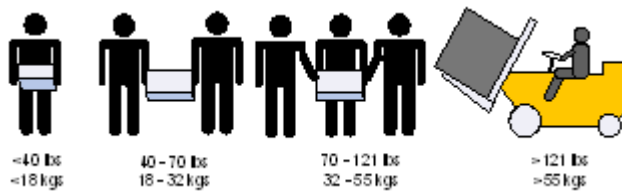

重设备

本设备极重，应使用机械式起重机来搬移，以避免人员受伤。



有触电的危险

有触电的危险！拆除风扇模组后，即可接触到机箱内模组空缺处的电源针脚。请勿将工具或机身零件放入机箱内风扇模组空缺处。



温度过高

本设备不应在超过所建议的最高环境温度的区域中运作：40°C (104°F)。此外，为了保证气流的流通正常，请在通风口旁保留至少 8 公分 (3 英寸) 的间距。



堆叠机箱

机箱不应堆叠在任何其他设备上。如果机箱掉落，可能造成人员受伤与设备损坏。



备用电源供应器连接时的电击危险

本设备附有备用电源供应器或在适当位置配有空白盖板。有关电源供应器，在空白盖板已取下或未牢牢固定的情况下，请勿操作本产品



双极/中性保险丝

本系统具有双极 / 中性保险丝。请拔掉所有电源线后，再打开本产品的盖板或碰触任何内部零件。



多电源输入座

电击与能源危害的危险。所有 PSU 均各自独立。请将所有电源供应器断电，以确保交换器设备内部的电源为关闭状态。



铜缆线的连接与移除

铜电缆重且不易弯折，因此应仔细连接或从连接器端口分离。请参阅电缆制造商了解特殊警告 / 说明。



机架安装与维修

此产品已安装在机架中或在机架中维修时，必须采取特定预防措施以确保系统维持稳定。一般您应该将设备从底部到顶端放满机架。



设备安装

本设备仅限由经过训练与 / 或合格的人员安装、更换或维修。



设备弃置

弃置本设备应遵照所有国内法规。



当地与国家电气法规

请遵照当地与国家电气法规安装本设备。



安装法规

请务必遵循最新版的国家电气法规，安装本设备。在北美地区，请务必遵循美国国家电工法规和加拿大电工法规中的适用规定，安装本设备。



更换电池

警告：只能以 UL 认可电池，且取得最大异常充电电流低于 4mA 认证的电池进行更换。若更换错误类型的电池，会有爆炸的危险。请依据指示弃置废电池。



UL 列名和 CSA 认证电源线

北美地区在接上电源时，请选用获得 UL 列名和 CSA 认证 3- 导体 [16AWG] 附成型插头，额定值为 125 V、[13 A]，长度至少 1.5 公尺 [六英尺]，但不超过 4.5 公尺的电源线。

欧洲地区在接上电源时，请选用国际协调式且标示有 <HAR> -3 字样、导体标示截面至少 1.0 平方公厘，额定值为 300 V，采用 PVC 绝缘的电源线。电源线需有成型插头，额定值为 250 V, 10 A。



高漏电流

警告：高漏电流；必须执行地线连接，然后再连接电源供应器。



安装法规

请务必遵循最新版的国家电气法规，安装本设备。在北美地区，请务必遵循美国国家电工法规和加拿大电工法规中的适用规定，安装本设备。



互连设备

连接至 RS232 设备和以太网路介面的缆线必须是 UL 认证类型 DP-1 或 DP-2。(请注意- 若放置于无 LPS 电路时)



切换开关不可用作机架或工作空间

小心：滑轨 / 导轨安装设备不可用作机架或工作空间。导轨不适用于将设备滑出机架使用。仅限永久安装在最后安置区域时使用，不可用于维修和保养。



WEEE 指令

根據 WEEE 指令 2002/96/EC，所有廢棄的電氣與電子設備 (EEE)，應分開集中，而且不應與一般家庭廢棄物一起棄置。請以負責和環保的方式棄置本產品及其所有零件。



挪威國家電源限制

本設備_僅限連接至挪威的 TN 電源系統和 IT 電源系統。

China CCC Warning Statement

在维修的时候一定要断开所有电源 (English translation"disconnect all power sources before service")



For non tropical use:

安全 说明 和标 记	汉文	“仅适用于非热带气候条件下安全使用。”
	藏文	《སྒྲིབ་དཔྱད་ཀྱི་སྐབས་ལ་འོ་ཚུལ་གྲིབ་དཔྱད་སྐབས་ལ་གྲུབ་པའི་ཕྱི་ལོ་དེ་སྔ་དུས་ལ་འཇུག་པར་བྱ་དགོས་པའོ།།》
	蒙古文	“ཚབ་ལེ་ས་ཁུལ་གྱི་གནས་གནས་མཉམ་པའི་ས་ཁུལ་ཁོ་ནར་ཉེན་མེད་ལེན་ཕྱོད་བྱས་འཇུག།”
	壮文	Dan hab yungh youq gij dienheiq diuzgen mbouj dwg diegndat haenz ancienz sawjyungh.
	维文	غەيرى ئىسسىق بەلباغ ھاۋا كىلىماتى شارائىتىدىلا بىخەتەر ئىشلەتكىلى بولىدۇ



For altitude 2000 meter and below:

安全 说明 和标 记	汉文	仅适用于海拔2000m以下地区安全使用。
	藏文	《2000m རྒྱུ་མཚན་ལོག་པའི་གོ་མོ་གྲུབ་པའི་ཕྱི་ལོ་དེ་སྔ་དུས་ལ་འཇུག་པར་བྱ་དགོས་པའོ།།》
	蒙古文	“བྱ་མཚན་ལོག་པའི་གོ་མོ་མཚན་གྱི་ས་ཁུལ་ཁོ་ནར་ཉེན་མེད་ལེན་ཕྱོད་བྱས་འཇུག།”
	壮文	Dan hab yungh youq gij digih haijbaz 2000m doxroengz haenz ancienz sawjyungh.
	维文	دېڭىز يۈزىدىن 2000 مېتر تۆۋەن رايونلاردا بىخەتەر ئىشلەتكىلى بولىدۇ

Warning for Class A:

声 明

此为 A 级产品，在生活环境中，该产品可能会造成无线电干扰。在这

种情况下，可能需要用户对其干扰采取切实可行的措施。

English translation of above statement

This is a Class A product. In a domestic environment this product may cause radio interference, in which case the user may be required to take adequate measures.

Taiwan BSMI Class A Statement - Warning to the User!

警告使用者:

此為甲類資訊技術設備，於居住環境中使用時，可能會造成射頻擾動，在此種情況下，使用者會被要求採取某些適當的對策。

Avertissements de sécurité pour l'installation (French)



Instructions d'installation

Veillez lire la totalité des instructions d'installation avant de relier l'équipement au secteur.



Blessures à cause du poids

Prévoyez assez de personnel pour soulever ce produit en toute sécurité.

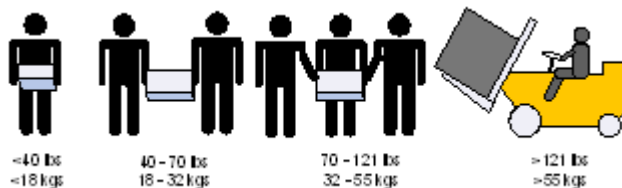

Équipement lourd

Cet équipement est lourd et doit être déplacé avec un système de levage mécanique pour éviter les blessures.



Danger d'électrocution

Danger d'électrocution ! Lorsque le module de ventilation est retiré, les broches d'alimentation sont exposées dans l'emplacement du module. NE PAS insérer d'outils ou la main dans l'emplacement du module.



Surchauffe

Cet équipement ne doit pas être en service dans un local dont la température dépasse le maximum recommandé de 45°C (113°F). En outre et pour garantir une circulation d'air correcte, laisser un espace d'au moins 8 cm (3") autour des orifices de ventilation.



Châssis empilé sur d'autres équipements

Le châssis ne doit pas être empilé sur d'autres équipements. S'il tombe, il peut endommager l'équipement ou entraîner des blessures.



Connexion de l'alimentation redondante : danger d'électrocution

Ce produit est équipé d'une alimentation redondante ou d'un cache si elle est absente. Dans ce dernier cas, ne pas faire fonctionner le produit si le cache est retiré ou mal fixé.



Fusibles phase/neutre

Ce système dispose de fusibles phase/neutre. Débranchez tous les cordons d'alimentation avant d'ouvrir le capot ou de toucher tout élément à l'intérieur.



Plusieurs prises d'alimentation

Risque et danger d'électrocution. Les alimentations sont toutes indépendantes. Pour s'assurer que le commutateur est bien hors tension, débranchez toutes les alimentations.



En cas d'orage, danger d'électrocution

Pendant un orage, ne pas travailler sur l'équipement ni brancher ou débrancher des câbles.



Connexion et déconnexion du câble en cuivre

Les câbles en cuivre sont lourds et peu flexibles. Par conséquent, il faut procéder avec soin pour les brancher ou les débrancher des connecteurs. Consulter le fabricant du câble pour obtenir des instructions ou des avertissements spécifiques.



Montage en rack et maintenance

Lors du montage ou de la maintenance de ce produit dans un rack, il faut faire spécialement attention pour s'assurer que l'ensemble reste stable. En règle générale, le rack doit être rempli en commençant par le bas.



Installation de l'équipement

Cet équipement ne doit être installé, remplacé et maintenu que par un personnel formé et qualifié.



Mise au rebut de l'équipement

La mise au rebut de cet équipement doit se faire conformément à toutes les lois et réglementations nationales.



Codes électriques locaux et nationaux

Cet équipement doit être installé conformément aux codes électriques locaux et nationaux.



Codes d'installation

Cet appareil doit être installé conformément à la version la plus récente des codes électrique nationaux. En Amérique du Nord, l'équipement doit être installé en respectant les exigences de l'US National Electrical Code et du Code canadien de l'électricité.



Remplacement de la batterie

Avertissement: ne remplacer qu'avec une batterie UL, certifiée pour accepter un courant de charge anormal maximal supérieur ou égal à 4 mA. Si la batterie n'est pas remplacée par un type correct, il y a un risque d'explosion. Les batteries usagées doivent être mises au rebut conformément aux instructions.



Cordon d'alimentation UL Listed et certifié CSA

Pour le branchement électrique en Amérique du Nord, utiliser un cordon d'alimentation UL Listed et CSA Certified, à 3 conducteurs [calibre 16 AWG], avec une prise moulée 125 V [13 A], faisant au moins 1,5 m de long [six pieds] et au plus 4,5 m.

Pour le branchement électrique en Europe, utiliser un cordon d'alimentation au format international harmonisé (marqué <HAR>), à 3 conducteurs d'au moins 1 mm² de section, 300 V, avec une gaine isolante en PVC. Le cordon doit avoir une prise moulée 250 V 10 A.



Courant de fuite élevé

Avertissement: courant de fuite élevé, une connexion à la terre est indispensable avant de brancher l'alimentation.



Codes d'installation

Cet appareil doit être installé conformément à la version la plus récente des codes électrique nationaux. En Amérique du Nord, l'équipement doit être installé en respectant les exigences de l'US National Electrical Code et du Code canadien de l'électricité.



Interconnexion des unités

Les câbles de connexion aux interfaces RS232 et Ethernet de l'appareil doivent être certifié UL de type DP-1 ou DP-2. (Note : en cas d'installation sur un circuit dont la puissance n'est pas limitée)

Protection contre les surintensités : le câblage de l'immeuble doit intégrer un dispositif certifié de protection contre les surintensités, calibré à 20 A et aisément accessible.



Ne pas utiliser comme étagère ou plan de travail

Attention: un équipement coulissant ou monté sur rail ne doit pas servir d'étagère ni de plan de travail. Les rails ne sont pas destinés à faire coulisser l'unité hors du rack. Ils sont destinés à une installation permanente à l'emplacement final, pas pour l'entretien ni la maintenance.



Directive DEEE

Selon la Directive 2002/96/CE (DEEE), tous les déchets d'équipements électriques et électroniques (EEE) doivent être collectés séparément et ne pas être mis au rebut avec les déchets ménagers habituels. Ce produit et toutes ses pièces doivent être mis au rebut d'une manière responsable, respectant l'environnement.



Restrictions concernant l'alimentation pour la Norvège

Cet appareil est prévu pour être relié à un système d'alimentation TN et un système d'alimentation informatique de Norvège uniquement.

Installation Sicherheitshinweise (German)



Installationsanleitungen

Lesen Sie alle Installationsanleitungen, bevor Sie das Gerät an die Stromversorgung anschließen.



Verletzungsgefahr wegen des Gewichts

Um das Produkt sicher anzuheben, genügend Personen einsetzen.



Schweres Gerät

Dieses Gerät ist schwer und muss mit einem mechanischen Hebegerät verschoben werden, um Verletzungen zu vermeiden.



Stromschlagrisiko

Stromschlagrisiko! Bei abgenommenem Ventilatormodul sind die Stromkontakte in der Modulvertiefung zugänglich. Es dürfen KEINE Werkzeuge oder Körperteile in die Vertiefung des Ventilatormoduls gelangen.



Übertemperatur

Dieses Gerät sollte nicht in einem Bereich mit einer Umgebungstemperatur über der maximal empfohlenen Temperatur von 45 °C (113 °F) betrieben werden. Es ist ein Luftstrom von 200 LFM bei maximaler Umgebungstemperatur erforderlich. Außerdem sollten mindestens 8 cm (3 in.) Freiraum um die Belüftungsöffnungen sein, um einen einwandfreien Luftstrom zu gewährleisten.



Stapeln des Chassis

Das Chassis sollte nicht auf andere Geräte gestapelt werden. Wenn das Chassis herunterfällt, kann es zu Verletzungen und Beschädigungen an Geräten führen.



Zweipolig/Neutrale Sicherung

Achtung: Zweipolige bzw. Neutralleiter-Sicherung im Netzteil. Netzstecker ziehen, um sicherzustellen, daß keine Spannung am Gerät anliegt. Entfernen Sie alle Netzkabel vor dem Öffnen der Abdeckung dieses Produkts oder dem Berühren der Innenteile.



Mehrere Stromeingänge

Risiko eines Stromschlags und Stomgefahr. Alle Stromversorgungseinheiten sind unabhängig. Trennen Sie alle Stromversorgungen, um einen abgeschalteten Zustand im Inneren der Switch-Plattform sicherzustellen.



Bei Gewitter - Elektrische Gefahr

Arbeiten Sie während eines Gewitters und Blitzschlag nicht am Gerät, schließen Sie keine Kabel an oder ab.



Anschließen/Trennen von Kupferkabel

Kupferkabel sind schwer und nicht flexible. Deshalb müssen sie vorsichtig an die Anschlüsse angebracht bzw. davon getrennt werden. Lesen Sie die speziellen Warnungen und Anleitungen des Kabelherstellers.



Rack-Montage und Wartung

Wenn dieses Produkt in einem Rack montiert oder gewartet wird, sind besondere Vorsichtsmaßnahmen zu ergreifen, um die Stabilität des Systems zu gewährleisten. Im Allgemeinen sollten Sie das Gestell von unten nach oben mit Geräten füllen.



Geräteinstallation

Diese Gerät sollte nur von geschultem und qualifiziertem Personal installiert, ausgetauscht oder gewartet werden.



Geräteentsorgung

Die Entsorgung dieses Geräts sollte unter Beachtung aller nationalen Gesetze Bestimmungen erfolgen.



Regionale und nationale elektrische Bestimmungen

Dieses Gerät sollte unter Beachtung der regionalen und nationalen elektrischen Bestimmungen installiert werden.



Installationscodes

Dieses Gerät muss entsprechend der aktuellsten Version des National Electrical Code installiert werden. In Nordamerika muss das Gerät gemäß den geltenden Anforderungen des US National Electrical Code und des Canadian Electrical Code installiert werden.



Akkuaustausch

Warnung: Nur durch von UL anerkannten Akkus ersetzen, die für maximalen anormalen Ladestrom von nicht weniger als 4mA zertifiziert sind. Es besteht Explosionsgefahr, wenn der Akku durch einen Akku eines falschen Typs ersetzt wird. Akkus gemäß den Anweisungen entsorgen.



UL- und CSA-zertifiziertes Netzkabel

Für Nordamerika Stromanschluss, wählen Sie ein Netzkabel, das UL-und CSA Certified 3 - Leiter, [18 AWG], mit einem angespritztem Stecker bewertet bei 125 V, [15], mit einer Mindestlänge von 1,5 m [Six Feet] aber nicht mehr als 4,5 m.

Für die europäischen Zusammenhang, wählen Sie ein Netzkabel, das international harmonisiert und der Aufschrift "<HAR>", 3 - Leiter, mindestens 0,75 mm² Draht, bewertet mit 300 V, mit einem PVC-Mantel isoliert. Das Kabel muss eine angespritztem Stecker bewertet bei 250 V, 10 A.



Hoher Ableitstrom

WARNUNG: Hohe Ableitstrom; Earth Verbindung, bevor Sie die Verbindung von wesentlicher Bedeutung werden.



Installationscodes

Dieses Gerät muss installiert sein, entsprechend auf die neueste Version des Landes National Electrical Code. Für Nordamerika, müssen in Übereinstimmung mit den geltenden Vorschriften in der US-amerikanischen National Electrical Code und dem Canadian Electrical Code.



Verbindung der Geräte untereinander

Kabel für den Anschluss an das Gerät RS232-und Ethernet-Schnittstellen müssen UL zertifiziert Typ DP-1 oder DP-2. (Hinweis-, wenn nicht mit Wohnsitz in LPS-Schaltung)

Überstromschutz: Eine leicht zugängliche Auflistung Abzweigung Überstrom-Schutzeinrichtung 20 A bewertet werden müssen in dem Gebäude Verkabelung.



Switch nicht als Regal oder Arbeitsplatz nutzen

Achtung: Auf Schieber/Schienen montiertes Gerät ist nicht als Regal oder Arbeitsbereich zu nutzen. Die Schienen sind nicht dafür bestimmt, die Einheit aus dem Gestell weg zu ziehen. Sie sind nur für die permanente Installation an einem endgültigen Standort gedacht, nicht für Instandhaltung und Wartung.



WEEE-Direktive

Gemäß WEEE Directive 2002/96/EC müssen alle elektrischen und elektronischen Abfallgeräte (EEE) separat gesammelt und nicht mit normalem Haushaltsmüll entsorgt werden. Dieses Produkt und alle seine Teile in verantwortungsvoller und umweltfreundlicher Art und Weise entsorgen.

Advertencias de seguridad de instalación (Spanish)



Instrucciones de instalación

Antes de conectar el equipo a la fuente de alimentación, leer todas las instrucciones de instalación.



Lesión corporal a causa de peso

Recorra a suficientes personas para levantar este producto sin.

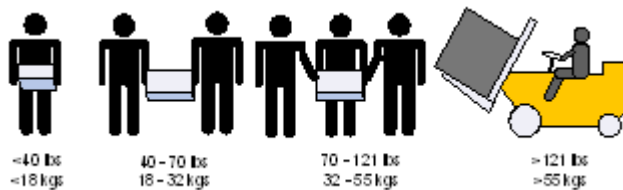

Equipos pesados

Dado que el equipo es pesado, se debe mover únicamente mediante un elevador mecánico, para evitar lesiones.



Riesgo de descarga eléctrica

Con el módulo del ventilador quitado, se obtiene acceso a las clavijas de alimentación desde dentro de la cavidad del módulo. NO introducir herramientas ni partes del cuerpo en la cavidad del módulo del ventilador.



Sobrettemperatura

No se debe utilizar el equipo en un área con una temperatura ambiente superior a la máxima recomendada: 45°C. Además, para garantizar una circulación de aire adecuada, se debe dejar como mínimo un espacio de 8 cm (3 pulgadas) alrededor de las aberturas de ventilación.



Apilamiento del chasis

Los chasis no se deben apilar sobre otros equipos. La caída del chasis podría causar lesiones corporales, así como daños al equipo.



Conexión redundante de fuente de alimentación: peligro de descarga

Este producto incluye una fuente de alimentación redundante o, en su lugar, una vacía. Si se dispone de una fuente de alimentación vacía, no utilizar el producto si su tapa está quitada o no está bien cerrada.



Fusible neutro o de polo doble

Dos fusibles, uno en el polo y otro en el neutro. Quitar los cables de corriente antes de abrir la tapa de este producto o tocar cualquier componente interno.

Tomas de alimentación múltiples

Riesgo de descarga eléctrica y peligro de corriente. Todas las fuentes de alimentación son independientes. Desconecte todas las fuentes de alimentación, para asegurar que no haya corriente alguna dentro de la plataforma de conmutación.

Al haber rayos: peligro de descarga

No utilizar el equipo ni conectar o desconectar cables durante períodos de actividad de rayos.



La conexión y desconexión de cables de cobre

Dado que los cables de cobre son pesados y no son flexibles, su conexión a los conectores y su desconexión se deben efectuar con mucho cuidado. Para ver advertencias o instrucciones especiales, consultar al fabricante del cable.



Montaje y mantenimiento del bastidor

Al instalar o realizar el mantenimiento de este aparato en un bastidor, es preciso adoptar precauciones especiales para garantizar que el sistema se mantenga estable. En general, en un bastidor, los equipos se deben instalar comenzando desde abajo hacia arriba.



Instalación del equipo

La instalación, el reemplazo y el mantenimiento de este equipo estarán a cargo únicamente de personal capacitado y competente.



Eliminación del equipo

La eliminación definitiva de este equipo se debe efectuar conforme a todas las leyes y reglamentaciones nacionales.



Códigos eléctricos locales y nacionales

Este equipo se debe instalar conforme a los códigos eléctricos locales y nacionales.



Códigos de instalación

Este dispositivo se debe instalar conforme a la versión más reciente de los códigos eléctricos nacionales del país en cuestión. En América del Norte, el equipo se debe instalar de acuerdo con las disposiciones vigentes del Código Eléctrico Nacional de los EE.UU. y del Código Eléctrico de Canadá.



Cambio de batería

Il y a danger d'explosion s'il y a remplacement incorrect de la batterie. Remplacer uniquement avec une batterie du même type ou d'un type équivalent recommandé par le constructeur. Mettre au rebut les batteries usagées conformément aux instructions du fabricant.



Cable de alimentación homologado por UL y con certificación CSA

En conexiones de América del Norte, seleccionar un cable de alimentación homologado por UL y con certificación CSA de tres conductores, [16 AWG], terminado en un enchufe moldeado con capuchón de 125 voltios nominal, [13 A], con una longitud mínima de 1,5 metros, pero no más de 4,5 metros.

En conexiones europeas, seleccionar un cable de alimentación armonizado internacionalmente y marcado "<HAR>", de tres conductores, hilo de 1,0 mm² como mínimo, 300 voltios nominal, con cobertura protectora aislante de PVC. El cable debe tener un enchufe moldeado con capuchón de 250 voltios nominal, 10 A.



Alta corriente de fuga

ADVERTENCIA: Alta corriente de fuga. Es esencial efectuar la conexión a tierra antes de conectar la alimentación.



Códigos de instalación

Este dispositivo se debe instalar conforme a la versión más reciente de los códigos eléctricos nacionales del país en cuestión. En América del Norte, el equipo se debe instalar de acuerdo con las disposiciones vigentes del Código Eléctrico Nacional de los EE.UU. y del Código Eléctrico de Canadá.



Interconexión de unidades

Los cables para la conexión con las interfaces RS232 y Ethernet de la unidad deben estar homologados por UL tipo DP-1 o DP-2. (Nota: cuando residen en circuito no de tipo LPS)
Protección contra sobrecargas: Al cableado del edificio se debe incorporar un dispositivo de protección contra sobrecargas de circuito derivado, de fácil acceso, con una corriente nominal de 20 A.



No utilizar el conmutador como estante ni como espacio de trabajo

Cuidado: Equipos montados en deslizadores o rieles no se deben utilizar como estantes ni como espacio de trabajo. La finalidad de los rieles no es deslizar la unidad hacia afuera del bastidor. Sirven solo para la instalación permanente en el lugar de destino final, no para fines de servicio o mantenimiento



Directiva WEEE

Conforme a la Directiva 2002/96/CE sobre RAEE, todos los residuos de equipos eléctricos y electrónicos (EEE) se deben recolectar por separado y no se deben eliminar junto con residuos domésticos. Al deshacerse de este producto y de todas sus partes, hágalo de una manera responsable y respetuosa con el medio ambiente.

Предупреждения по технике безопасности при установке (Russian)



Инструкция по установке

Перед подключением оборудования к источнику питания следует ознакомиться с инструкцией по установке.



Травмы при переносе тяжелых предметов

Для поднятия этого изделия следует задействовать достаточное количество людей.

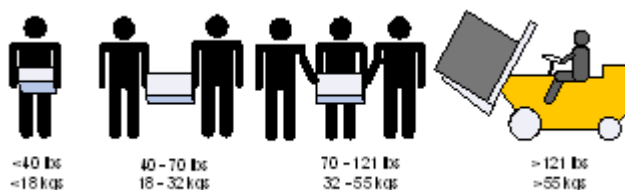

Тяжелое оборудование

Это тяжелое оборудование, поэтому его следует перемещать с помощью механического подъемника во избежание травм.



Опасность поражения электрическим током

Опасность поражения электрическим током! Когда снят вентиляторный модуль, существует возможность повреждения контактов питания в его углублении. НЕ вставлять инструменты или части тела в углубление вентиляторного модуля.



Перегрев

Не эксплуатировать это оборудование в помещении с температурой окружающей среды, превышающей максимально рекомендуемое значение: 45 °C (113 °F). Более того, для надлежащей вентиляции следует обеспечить зазор вокруг вентиляционных отверстий не менее 8 см (3 дюйма).



Установка шасси поверх другого оборудования

Не устанавливать шасси поверх другого оборудования. Падение шасси может привести к травмам и повреждению оборудования.



Опасность поражения электрическим током резервного источника питания

В этом изделии установлен резервный источник питания или модуль-заглушка. Если установлен модуль-заглушка, не эксплуатировать изделие со снятой или ненадежно закрепленной крышкой модуля-заглушки.



Двухполюсный предохранитель на фазном и нейтральном проводах

В этой системе установлен двухполюсный предохранитель на фазном и нейтральном проводах. Открывать кожух этого изделия или касаться внутренних деталей можно только после отсоединения всех шнуров питания.

Несколько источников питания

Опасность поражения электрическим током и опасные энергетические воздействия. Блоки питания независимы друг от друга. Чтобы обесточить все компоненты внутри платформы коммутации, следует отсоединить все блоки питания.

Опасность поражения электрическим током во время грозы

Во время грозы запрещается работать с оборудованием и подключать или отключать кабели.



Подсоединение и отсоединение медных кабелей

Медные кабели тяжелые и негибкие, поэтому следует осторожно их подсоединять и отсоединять. За особыми предупреждениями и указаниями следует обратиться к производителю кабеля.



Установка или обслуживание в стойке

При установке или обслуживании этого изделия в стойке следует обеспечить устойчивость системы. Как правило, стойка заполняется оборудованием снизу вверх.



Установка оборудования

Устанавливать, заменять и/или обслуживать это оборудование должен только подготовленный и квалифицированный персонал.



Утилизация оборудования

Это оборудование утилизируется в соответствии с национальными законами и постановлениями.



Местные и национальные правила установки электрооборудования

Это оборудование устанавливается в соответствии с местными и национальными правилами установки электрооборудования.



Правила установки электрооборудования

Это устройство устанавливается в соответствии с последним изданием национальных правил установки электрооборудования. В Северной Америке оборудование устанавливается в соответствии с действующими требованиями Национальных правил эксплуатации и обслуживания электрических установок США и Канады.



Замена аккумулятора

Осторожно! Заменять только аккумулятором, одобренным организацией UL и рассчитанным на максимальный аномальный зарядный ток не менее 4 мА. Существует

риск взрыва при замене аккумулятора другим аккумулятором неправильного типа. Отработавшие аккумуляторы утилизируются в соответствии с указаниями.



Шнур питания, включенный в номенклатуру UL и сертифицированный Канадской ассоциацией стандартизации (CSA)

Подключение к электропитанию в Северной Америке выполняется с помощью шнура питания, включенного в номенклатуру UL и сертифицированного Канадской ассоциацией стандартизации (CSA), 3-жильного, [16 AWG], длиной от 1,5 м [6 футов] до 4,5 м, с литой вилкой, рассчитанной на 125 В [13 А].

Подключение к электропитанию в Европе выполняется с помощью гармонизированного шнура питания с маркировкой <HAR>, 3-жильного, с сечением жилы не менее 1,0 мм², рассчитанного на номинальное напряжение 300 В, с ПВХ оболочкой. Шнур должен иметь литую вилку, рассчитанную на 250 В, 10 А.



Высокий ток утечки

Осторожно! Высокий ток утечки. Заземлить перед подключением к электропитанию.



Правила установки электрооборудования

Это устройство устанавливается в соответствии с последним изданием национальных правил установки электрооборудования. В Северной Америке оборудование устанавливается в соответствии с действующими требованиями Национальных правил эксплуатации и обслуживания электрических установок США и Канады.



Защита от перегрузки по току

Цепь подвода питания должна быть оборудована устройством защитного отключения от сети на ток 20А, которое находится в легкодоступном месте.



Подсоединение устройств

Для подключения к разъемам RS232 и Ethernet используются кабели типа DP-1 или DP-2, сертифицированные организацией UL. (Примечание. При подключении к сети без ограниченного источника электропитания)

Максимальная токовая защита. В проводку здания в легкодоступном месте следует включить устройство защиты от перегрузки по току номиналом 20 А.



Не использовать коммутатор как полку или рабочую поверхность

Внимание! Оборудование, установленное на направляющих, не должно использоваться как полка или рабочая поверхность. Направляющие не предназначены для удерживания устройства, выдвинутого из стойки. Они предназначены для стационарной установки только в конечном положении и не используются для обслуживания устройства.



Директива WEEE

В соответствии с Директивой 2002/96/EC (WEEE) отходы электрического и электронного оборудования должны собираться и утилизироваться отдельно от обычных бытовых отходов. Следует утилизировать это изделие и все его части ответственным и экологически безопасным способом.

Avertismente privind siguranța la instalare (Romanian)



Instrucțiuni de instalare

Citiți toate instrucțiunile de instalare înainte de a conecta.



Accidentare cauzată de greutate

Apelați la un număr suficient de persoane pentru a ridica în siguranță acest produs.

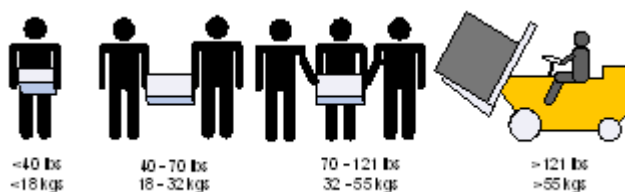

Echipament greu

Acest echipament este greu și trebuie să fie mutat folosind un dispozitiv mecanic de ridicare pentru a evita producerea de leziuni.



Risc de șoc electric

Odată ce modulul ventilator este îndepărtat, pinii electrici sunt accesibili în cavitatea modulului. NU introduceți instrumente sau părți din corp în cavitatea modulului ventilator.



Temperatură în exces

Acest echipament nu trebuie să fie acționat într-o zonă unde temperatura ambiantă depășește valoarea maximă recomandată: 45°C (113°F). În plus, pentru a asigura un flux de aer adecvat, lăsați un spațiu liber de cel puțin 8 cm (3 inchi) în jurul fantelor de ventilare.



Suprapunerea cadrului

Cadrul nu trebuie să fie suprapus peste niciun alt echipament. În cazul în care cadrul cade, poate cauza leziuni corporale și deteriorări ale echipamentului.



Conexiunea la o sursă de alimentare electrică suplimentară - pericol electric

Acest produs include o sursă de alimentare suplimentară sau un spațiu gol în locul acesteia. În cazul în care spațiul pentru sursa de alimentare este gol, nu operați produsul când capacul orb este îndepărtat sau nu este fixat în mod sigur.



Siguranță fuzibilă bipolară/neutră

Acest sistem este prevăzut cu siguranță fuzibilă bipolară/neutră. Îndepărtați toate cordonurile de alimentare înainte de a deschide capacul acestui produs sau înainte de a atinge orice componente interne.

Multiple mufe electrice

Risc de șoc electric și pericol electric. Toate aparatele cu alimentare de la rețea sunt independente. Deconectați toate sursele de alimentare cu energie pentru a asigura decuplarea în interiorul platformei de comutare.

În timpul descărcărilor electrice - pericol electric

În timpul perioadelor cu descărcări electrice luminoase, nu lucrați cu echipamentul sau nu conectați sau deconectați cablurile.



Conectarea/deconectarea cablului din cupru

Cablurile din cupru sunt grele și inflexibile, de aceea trebuie să fie atașate sau detașate de conectori cu grijă. Consultați producătorul de cabluri pentru avertismente/instrucțiuni speciale.



Montarea sau depanarea într-un rack

Când acest produs este montat sau depanat într-un rack, trebuie să fie luate măsuri de precauție speciale pentru a se asigura că sistemul rămâne stabil. În general, trebuie să umpleți rack-ul cu echipamente începând de jos în sus.



Instalarea echipamentului

Acest echipament trebuie să fie instalat, înlocuit și/sau depanat numai de către personal instruit și calificat.



Eliminarea echipamentului

Eliminarea acestui echipament trebuie să se realizeze în conformitate cu toate legile și regulamentele naționale.



Codurile electrice locale și naționale

Acest echipament trebuie să fie instalat conform codurilor electrice locale și naționale.



Codurile de instalare

Acest dispozitiv trebuie să fie instalat în conformitate cu ultima versiune a codurilor electrice naționale ale țării în cauză. Pentru America de Nord, echipamentul trebuie să fie instalat conform cerințelor aplicabile din Codul electric național al SUA și Codul electric canadian.



Înlocuirea bateriei

Avertisment: Înlocuiți numai cu o baterie recunoscută UL, certificată pentru curent de încărcare anormal maxim de minimum 4 mA

Există risc de explozie în cazul în care bateria este înlocuită cu o baterie necorespunzătoare. Eliminați bateriile folosite în conformitate cu instrucțiunile.



Cordon de alimentare electrică înregistrat UL și certificat CSA

Pentru conectarea la o sursă de alimentare pentru America de Nord, selectați un cordon de alimentare care este înregistrat UL și certificat CSA, cu 3 conductoare, [16 AWG], terminat cu o fișă turnată, cu putere nominală egală cu 125 V, [13 A], cu o lungime de minimum 1,5 m [șase picioare], dar nu mai lung de 4,5 m.

Pentru conectarea la o sursă de alimentare în Europa, selectați un cordon de alimentare care este armonizat la nivel internațional și marcat „<HAR>”, cu 3 conductoare, cu minimum 2 fire de 1,0 mm, cu putere nominală egală cu 300 V și cu o manta izolantă din PVC. Cordonul de alimentare trebuie să fie prevăzut cu o fișă turnată cu putere nominală egală cu 250 V, 10 A.



Curent de scurgere de înaltă frecvență

Avertisment: Curent de scurgere de înaltă frecvență; Împământarea este esențială înainte de a conecta sursa de alimentare.



Codurile de instalare

Acest dispozitiv trebuie să fie instalat în conformitate cu ultima versiune a codurilor electrice naționale ale țării în cauză. Pentru America de Nord, echipamentul trebuie să fie instalat conform cerințelor aplicabile din Codul electric național al SUA și Codul electric canadian.



Interconectarea unităților

Cablurile pentru conectarea la unitatea RS232 și la interfețele Ethernet trebuie să fie de tipul DP-1 sau DP-2 certificate UL. (Notă- când se regăsesc într-un circuit non-LPS) Protecție la supracurent: Un dispozitiv de protecție la supracurent, înregistrat în circuitul de ramificare, ușor accesibil și cu o putere nominală egală cu 20 A trebuie să fie integrat în cablajul clădirii.



Nu utilizați comutatorul ca raft sau spațiu de lucru

Atenție: Echipamentul montat pe o linie de alunecare/șină nu va fi utilizat ca raft sau spațiu de lucru. Scopul șinelor nu este de a glisa unitatea de pe rack. Acestea sunt destinate instalării permanente numai la punctul final de oprire și nu vor fi folosite pentru depanare și întreținere



Directiva DEEE

În conformitate cu Directiva DEEE 2002/96/CE, toate deșeurile de echipamente electrice și electronice (EEE) trebuie colectate separat și nu trebuie eliminate împreună cu deșeurile menajere obișnuite. Eliminați acest produs și toate componentele sale în mod responsabil și ecologic.



Restricții electrice pentru Norvegia

This unit is intended for connection to a TN power system and an IT power system of Norway only.

Sigurnosna upozorenja za instaliranje (Croatian)



Upute za instaliranje

Pažljivo pročitajte upute za instaliranje prije spajanja opreme na izvor električne energije.



Tjelesne ozljede uslijed težine

Kako biste sigurno podignuli ovaj proizvod, koristite dovoljan broj ljudi.

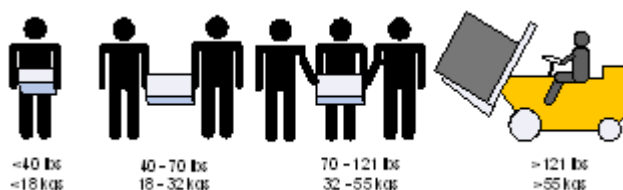

Teška oprema

Ova oprema je vrlo teška i treba se premještati pomoću mehaničkog dizala kako bi se izbjegle ozljede.



Rizik od strujnog udara!

Rizik od strujnog udara! S uklonjenim modulom ventilatora, perima napajanja se može pristupiti u otvoru modula. NEMOJTE umetati alat ili dijelove tijela u otvor modula ventilatora.



Pregrijavanje

Ovom se opremom ne bi trebalo rukovati u područjima s temperaturom okoline koja premašuje najviše preporučene vrijednosti: 45 °C (113 °F). Osim toga, kako bi se osigurao odgovarajući protok zraka, omogućite najmanje 8 cm (3 inča) razmaka oko otvora ventilatora.



Slaganje kućišta

Kućište se ne bi trebalo slagati na drugu opremu. Ako kućište padne, može izazvati tjelesne ozljede i oštećenje opreme.



Redundantno napajanje - Opasnost od električne energije

Ovaj proizvod uključuje redundantno napajanje ili prazan prostor na njegovu mjestu. U slučaju praznog prostora za napajanje, nemojte rukovati proizvodom ako je poklopac uklonjen ili ako nije dobro pričvršćen.



Dvopolni/neutralni osigurači

Ovaj sustav raspolaže dvopolnim/neutralnim osiguračima. Uklonite sve kabele napajanja prije otvaranja poklopca proizvoda ili dodirivanja unutarnjih dijelova.

Višestruki ulazi za napajanje

Rizik od strujnog udara i opasnost od električne energije. PSU jedinice su neovisne. Odspojite sva napajanja kako biste osigurali stanje bez napajanja unutar platforme preklopnika.

Tijekom udara munje - Opasnost od električne energije

Tijekom djelovanja munja, nemojte raditi na opremi ili spajati ili odspajati kabele.



Spajanje/Odspajanje bakrenog kabela

Bakreni kabele su teški i nesavjetljivi i kao takvi se moraju pažljivo priključiti na ili isključiti iz konektora. Obratite se proizvođaču kabela za posebna upozorenja/upute.



Montaža ormarića i servisiranje

Kad se proizvod montira ili se servisira u ormariću, moraju se poduzeti posebne mjere opreza kako bi se osiguralo da sustav ostane stabilan. Općenito, trebali biste ispunjavati ormarić s opremom počevši od dna prema vrhu.



Instaliranje opreme

Ovu bi opremu trebalo instalirati, zamjenjivati i/ili servisirati samo obučeno i kvalificirano osoblje.



Odlaganje opreme

Odlaganje opreme trebalo bi se vršiti sukladno nacionalnim zakonima i propisima.



Lokalni i nacionalni električni kodovi

Ova oprema trebala bi se instalirati u skladu s lokalnim i nacionalnim električnim kodovima.



Instalacijski kodovi

Ovaj se uređaj mora instalirati sukladno najnovijoj verziji nacionalnih električnih kodova države. U Sjevernoj Americi oprema se mora instalirati sukladno važećim zahtjevima navedenim u US National Electrical Code i Canadian Electrical Code.



Zamjena baterije

Upozorenje: Bateriju zamijenite samo baterijom iz serije UL koja je certificirana za maksimalnu nepravilnu struju punjenja ne manju od 4 mA
Postoji rizik od eksplozije ako se baterija zamijeni neodgovarajućom vrstom. Odložite prazne baterije sukladno uputama.



UL CSA kabel napajanja

Za sjevernoameričku mrežu odaberite kabel napajanja koji je na UL listi i sa CSA certifikatom, 3 - žilni, [16 AWG] (16 AWG) koji završava lijevanim utikačem nazivnog napona od 125 V, [13 A], minimalne duljine od 1,5 m [six feet] (šest stopa), ali ne dulji od 4,5 m.

Za europsku mrežu odaberite kabel napajanja koji je međunarodno usklađen i označen "<HAR>", 3 - žilni, s najmanje 1,0 mm² žice, nazivnog napona od 300 V, s PVC izolacijom. Kabel mora imati lijevani utikač nazivnog napona od 250 V, nazivne struje od 10 A.



Veliko curenje struje

Upozorenje: Veliko curenje struje; Prije spajanja napajanja nužno je spojiti uzemljenje.



Instalacijski kodovi

Ovaj se uređaj mora instalirati sukladno najnovijoj verziji nacionalnih električnih kodova države. U Sjevernoj Americi oprema se mora instalirati sukladno važećim zahtjevima navedenim u US National Electrical Code i Canadian Electrical Code.



Interkonekcija uređaja

Kabli za spajanje na jedinicu RS232 i Ethernet sučelja moraju biti s UL certifikatom vrste DP-1 ili DP-2. (Napomena - kad se nalazi u krugu bez LPS vodiča) Zaštita od strujnog preopterećenja: Uvijek dostupni odobreni zaštitni uređaji od strujnog preopterećenja nazivne struje od 20 A moraju se ugraditi u ožičenje zgrade.



Nemojte koristiti preklopnik kao policu ili radnu površinu

Pozor: Oprema montirana na klizalice/vodilice ne bi se trebala koristiti kao polica ili radna površina. Vodilice nisu namijenjene za povlačenje uređaja iz ormarića. Služe samo za trajnu instalaciju na konačnom položaju, a ne za servisiranje i održavanje.



WEEE direktiva

Sukladno WEEE direktivi 2002/96/EZ, sav električni i elektronički otpad (EEE) trebao bi se prikupljati zasebno i ne bi se trebao odlagati kao običan kućanski otpad. Odlaganje ovog proizvoda i svih njegovih dijelova vršite na odgovoran i ekološki način.



Električna ograničenja države Norveške

Ovaj je uređaj namijenjen samo za spajanje na električni sustav s TN uzemljenjem i na električni sustav s IT uzemljenjem države Norveške.

Avvertenze di sicurezza per l'installazione (Italian)



Istruzioni di installazione

Leggere tutte le istruzioni di installazione prima di collegare l'apparecchiatura all'alimentazione.



Lesioni a causa del peso

Usare un numero di persone sufficiente per sollevare in sicurezza questo prodotto.

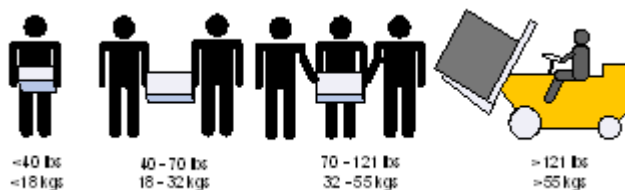

Apparecchiatura pesante

Questa apparecchiatura è molto pesante e va spostata mediante un sollevatore meccanico, per evitare lesioni.



Rischio di scosse elettriche!

Con il modulo ventola rimosso, i pin di alimentazione sono accessibili all'interno della cavità del modulo. NON inserire strumenti o parti del corpo nella cavità del modulo della ventola.



Temperatura eccessiva

Questa apparecchiatura non va utilizzata in un'area con una temperatura ambiente superiore a quella massima consigliata: $45\text{ }^{\circ}\text{C}$ ($113\text{ }^{\circ}\text{F}$). Inoltre, per assicurare un flusso d'aria adeguato, lasciare almeno 8 cm (3 pollici) di spazio attorno alle aperture di ventilazione.



Impilare lo chassis

Kućište se ne bi trebalo slagati na drugu opremu. Ako kućište padne, može izazvati tjelesne ozljede i oštećenje opreme.



Collegamento di alimentazione ridondante - Pericoli elettrici

Questo prodotto è dotato di un alimentatore ridondante o, qualora esso non sia installato, di uno spazio vuoto. Qualora l'alimentatore non sia installato, non utilizzare il prodotto con il coperchio rimosso o non fissato correttamente.



Fusibili fase/neutro

Questo sistema dispone di fusibili fase/neutro. Rimuovere tutti i cavi di alimentazione prima di aprire il coperchio di questo prodotto o di toccare parti interne.



Prese di alimentazione multiple

Rischio e pericolo di scosse elettriche. Gli alimentatori sono tutti indipendenti. Scollegare tutti gli alimentatori per assicurarsi che il commutatore non sia sotto tensione

 Durante i temporali, pericolo di scosse elettriche

Durante i temporali, non effettuare interventi sull'apparecchiatura e non collegare o scollegare i cavi.

 Collegamento/scollegamento del cavo di rame

I cavi di rame sono pesanti e non flessibili. Di conseguenza, vanno collegati o scollegati con cura dai connettori. Per avvertenze/istruzioni speciali, rivolgersi al produttore di cavi.

 Montaggio su rack e manutenzione

Quando questo prodotto viene montato o sottoposto a manutenzione su un rack, è necessario adottare delle precauzioni speciali per assicurarsi che il sistema resti stabile. In generale, il rack va riempito con apparecchiature, procedendo dal basso verso l'alto.

 Installazione dell'apparecchiatura

Questa apparecchiatura va installata, sostituita e/o sottoposta a manutenzione solo da personale addestrato e qualificato.

 Smaltimento dell'apparecchiatura

Lo smaltimento di questa apparecchiatura va effettuato in conformità con tutte le leggi e le normative nazionali.

 Codici elettrici locali e nazionali

Questa apparecchiatura va installata in conformità con le norme elettriche locali e nazionali.

 Codici di installazione

Questo dispositivo va installato in conformità con l'ultima versione dei codici elettrici nazionali del Paese. Per il Nord America, l'apparecchiatura va installata in conformità con i requisiti applicabili del "codice elettrico nazionale USA" e del "codice elettrico canadese".

 Sostituzione della batteria

Avvertenza: Sostituire solo con una batteria UL, certificata per accettare una corrente di ricarica anomala massima non inferiore a 4 mA. Se la batteria non viene sostituita con una batteria di tipo corretto, vi è il rischio di esplosione. Smaltire le batterie usate in conformità con le istruzioni.

 Cavo di alimentazione UL e munito di certificazione CSA

Per una connessione di alimentazione nordamericana, selezionare un cavo di alimentazione di tipo UL e munito di certificazione CSA, a 3 conduttori, [16 AWG], terminato con una spina stampata con tensione nominale pari a 125 V, [13 A], di lunghezza minima pari a 1,5 m [sei piedi] ma non più lunga di 4,5 m. Per una connessione europea, selezionare un cavo di alimentazione armonizzato a livello internazionale e contrassegnato da "<HAR>", a 3

conduttori, minimo 1,0 mm² fili, con guaina isolante in PVC. Il cavo deve disporre di una spina stampata di potenza nominale pari a 250 V, 10 A.



Corrente di dispersione elevata

Avvertenza: corrente di dispersione elevata; il collegamento a terra è essenziale prima di collegare l'alimentazione.



Codici di installazioni

Questo dispositivo va installato in conformità con l'ultima versione dei codici elettrici nazionali del Paese. Per il Nord America, l'apparecchiatura va installata in conformità con i requisiti applicabili del "codice elettrico nazionale USA" e del "codice elettrico canadese".



Interconnessione delle unità

I cavi per il collegamento all'unità RS232 e alle interfacce Ethernet devono disporre della certificazione UL ed essere del tipo DP-1 o DP-2. (Nota: in caso di installazione su un circuito la cui potenza non è limitata) Protezione contro le sovracorrenti: la cablatura dell'edificio deve integrare un dispositivo di protezione contro le sovracorrenti di potenza nominale pari a 20.



Non utilizzare lo switch come scaffale o piano di lavoro

Attenzione: un'apparecchiatura scorrevole o montata su binari non va utilizzata come scaffale o piano di lavoro. I binari non sono progettati per far scorrere e allontanare l'unità dal rack. Essi sono destinati all'installazione permanente solo nel luogo di lavoro e non vengono utilizzati per assistenza e manutenzione



Direttiva RAEE

Secondo la direttiva RAEE 2002/96/EC, tutti i rifiuti da apparecchiature elettriche ed elettroniche (RAEE) vanno raccolti separatamente e non smaltiti nei normali rifiuti domestici. Smaltire questo prodotto e tutte le sue parti in modo responsabile e rispettoso dell'ambiente



Limitazioni relative all'alimentazione per la Norvegia

Questa apparecchiatura è progettata esclusivamente per il collegamento a un sistema di alimentazione TN e a un sistema di alimentazione IT.

Montaj Güvenlik Uyarıları (Turkish)



Montaj Talimatları

Ekipmanı güç kaynağına bağlamadan önce tüm montaj talimatlarını okuyun.



Ağırlık Nedeniyle Fiziksel Yaralanma

Bu ürünü güvenli bir şekilde kaldırmak için yeterli sayıda insandan yardım alın.



Ağır Ekipman

Bu ekipman çok ağırdır ve yaralanmaları önlemek için ekipmanın mekanik asansör kullanılarak taşınması gerekir.



Elektrik Çarpması Riski!

Fan modülüyle çıkarılan güç pimlerine modül boşluğu içinde erişilebilir. Fan modülü boşluğuna alet veya gövde parçaları yerleştirmeyin.



Aşırı Isınma

Bu ekipman, önerilen maksimum ortam sıcaklığını aşan alanlarda çalıştırılmamalıdır: 45 °C (113 °F). Ayrıca, düzgün hava akışı sağlamak için havalandırma deliklerinin etrafında en az 8 cm (3 inç) açıklık bırakılmalıdır.



Şasi İstif

Şasinin diğer herhangi bir ekipmanın üzerine istiflenmemesi gerekir. Şasi düşerse, fiziksel yaralanmalara ve ekipmanda hasara neden olabilir.



Yedekli Güç Kaynağı Bağlantısı -Elektrik Çarpma Tehlikesi

Bu ürün, yedekli güç kaynağı veya onun yerine boş elektrik kutusu içerir. Güç kaynağı için boş elektrik kutusu varsa, kutunun kapağı açıkken veya tam olarak kapatılmamışken ürünü çalıştırmayın.



Çift Kutuplu/Nötr Kesmeli Sigorta

Bu sistemde çift kutuplu/nötr kesmeli sigorta kullanılmaktadır. Ürünün kapağını açmadan veya herhangi bir iç parçaya dokunmadan önce bütün güç kablolarını çıkartın.



Çoklu Güç Girişleri

Elektrik çarpması riski ve enerji tehlikesi. Bütün PSU'lar (Güç Kaynağı Üniteleri) ayrıdır. Anahtar platformundaki gücü kapatmak için tüm güç kaynaklarının bağlantılarını kesin.



Şimşek - Elektrik Çarpma Tehlikesi

Gökyüzünde şimşek çaktığı zamanlarda, ekipman üzerinde çalışmayın veya kablo bağlamayın ya da kablo bağlantısı kesmeyin.



İskele Montajı ve Bakım

Bu ürün bir iskelede monte edildiyse veya bir iskele ile sunulduysa, sistemin sabit kalması için özel önlemler alınmalıdır. Genelde, ekipmanları iskeleye aşağıdan yukarı doğru doldurmanız gerekir.



Ekipman Montajı

Ekipmanın yalnızca eğitimli ve nitelikli personel tarafından monte edilmesi, değiştirilmesi ve/veya bakımının yapılması gerekir.



Ekipmanın Atılması

Bu ekipmanın imhasında tüm ulusal yasalara ve düzenlemelere uyulması gerekir.



Yerel ve Ulusal Elektrik Kodları

Bu ekipmanın montajında yerel ve ulusal elektrik kodlarına uyulması gerekir.



Montaj Kodları

Bu cihazın, ülke ulusal elektrik kodlarının son sürümüne göre monte edilmesi gerekir. Kuzey Amerika için, ekipmanın ABD Ulusal Elektrik Kodu ve Kanada Elektrik Kodu'nun uygulama koşullarına göre monte edilmesi gerekir.



Pilin Değiştirilmesi

Uyarı: Yalnızca, maksimum düzgümsüz şarj akımı 4mA'dan az olmayan, UL Onaylı pillerle değiştirin. Yanlış pil türü ile değiştirildiğinde patlama tehlikesi bulunmaktadır. Kullanılmış pillerden talimatlara uygun bir şekilde kurtulun.



UL Kayıtlı ve CSA Onaylı Güç Kaynağı Kablosu

Kuzey Amerika'da güç bağlantısı için, UL Kayıtlı ve CSA Onaylı bir güç kaynağı kablosu seçin, 3 - iletken, [16 AWG], 125 V değerinde, kalıplanmış bir fişle biten, [13 A], en az 1,5 m (altı fit) uzunluğunda fakat 4,5 m'den uzun olmayan bir kablo. Avrupa'da güç bağlantısı için, uluslararası uyumlu ve "<HAR>" işaretli, 3 - iletken, en az 1,0 mm² tel, 300 V değerinde ve PVC yalıtımlı bir güç kaynağı kablosu seçin. Kablonun 250 V, 10 A değerinde bir kalıplanmış fişi olması gerekmektedir.



Yüksek Kaçak Akım

Yüksek kaçak akım varsa; güç kaynağına bağlanmadan önce mutlaka topraklama bağlantısı yapılmalıdır.



Montaj Kodları

Bu cihazın, ülke ulusal elektrik kodlarının son sürümüne göre monte edilmesi gerekir. Kuzey Amerika için, ekipmanın ABD Ulusal Elektrik Kodu ve Kanada Elektrik Kodu'nun uygulama koşullarına göre monte edilmesi gerekir.



Ünitelerin Ara Bağlantısı

RS232 ünitesini ve Ethernet Arabirimlerini bağlayacak olan kabloların UL onaylı DP-1 veya DP-2 tipi olması gerekir. (Not- LPS olmayan devreye aitse) Aşırı Akım Koruması: Kolayca erişilebilecek 20 V Kayıtlı devre parçası aşırı akım koruma cihazının bina elektrik şebekesinde kurulu olması gerekir.



Anahtarı Raf veya Çalışma Alanı olarak kullanmayın!

Dikkat: Sürgülü/raylı ekipman raf veya çalışma alanı olarak kullanılamaz. Raylar üniteyi iskeleden uzağa kaydırmak için yapılmamıştır. Sadece, ekipmanın son olarak duracağı yerdeki kalıcı montaj içindir, servis veya bakım için kullanılamaz.



WEEE Yönergesi

WEEE Yönergesi 2002/96/EC uyarınca, tüm elektrikli ve elektronik ekipman atıkları (EEE) ayrı olarak toplanmalı ve evsel atıklarla birlikte çöpe atılmamalıdır. Bu ürün ve tüm parçaları çevreye dost ve sorumlu bir şekilde imha edilmelidir.



Norveç Güç Kısıtlamaları

Bu ünite, bir TN güç sistemine ve sadece Norveç'in IT güç sistemine bağlanmak içindir.

Japan VCCI Statement

この装置は、クラス A 情報技術装置です。この装置を家庭環境で使用すると電波妨害を引き起こすことがあります。この場合には使用者が適切な対策を講ずるよう要求されることがあります。 VCCI-A

הוראות בטיחות בהתקנה (Hebrew)

הוראות התקנה

קרא היטב את כל הוראות ההתקנה לפני חיבור המוצר לחשמל.

תקן ישראלי

יש להתקין את המוצר תוך הקפדה על תקנות החשמל הנהוגות בישראל, ולעשות שימוש ביחידת חלוקת כוח העומדת בתקן ישראל (ת"י) 32

חבלת גוף כתוצאה מנשיאת משקל יתר 

נדרשת נוכחותם של מספר מתקינים כדי להרים את המוצר בבטחה.

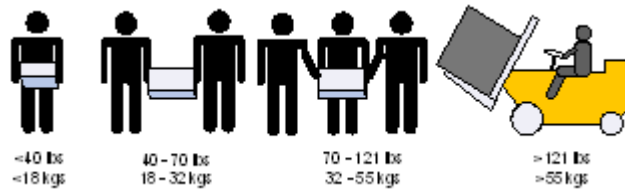

ציוד כבד 

המוצר כבד, ויש לשנעו באמצעות מעלית מכאנית כדי למנוע חבלה.

סכנת התחשמלות!

סכנת התחשמלות! בעת שיחידת המאוורר מפורקת, רכיבי חשמל נחשפים בחלל הריק. אין להחדיר כלים או איברי גוף לחלל המיועד להרכבת היחידה

התחממות יתר 

אין להפעיל את המוצר באיזור שבו טמפרטורת החדר עולה על הטמפרטורה המקסימלית: 45°C (113°F). המומלצת בנוסף, כדי להבטיח כניסת אוויר תקינה, יש לוודא כי קיים שטח פנוי של 8 ס"מ (3 אינץ') לפחות סביב פתחי האוורור

ערימת המערכת 

אין לערום את המערכת על גבי ציוד אחר. במקרה של נפילה, עשויים להגרם נזקי גוף ורכוש.

חיבור ספק כוח נוסף - סכנת התחשמלות

המערכת מכילה ספק כוח נוסף לגיבוי, או, בחלק מהמקרים, חלל ריק המאפשר הרכבת ספק כזה. אין לעשות שימוש במערכת כשהמכסה החוסם את החלל הריק אינו סגור כהלכה

מספר שקעים חשמליים

סכנת התחשמלות ואזהרת אנרגיה. כל אחד מספקי הכוח פועל באופן עצמאי. יש לנתק את כל ספקי הכוח, כדי להבטיח ניתוק מוחלט של המערכת. מזרם חשמלי

בעת סופות ברקים - סכנת התחשמלות!

בעת סופות ברקים, אין להפעיל את המערכת או לחבר/לנתק כבלים.

חיבור או ניתוק של כבלי נחושת 

כבלי נחושת הם כבדים וקשיחים. לפיכך, יש לחברם ולנתקם מהמחברים בזירות רבה. לאזהרות נוספות, יש לעיין בעלון לצרכן מטעם יצרן הכבלים



הרכבה על גבי מדף בארון

כאשר מרכיבים מוצר זה על גבי מדף בארון, יש לנקוט באמצעי זהירות מיוחדים בכדי להבטיח שיותר יציב.. ככלל, יש להתחיל למלא את הארון מהמדף התחתון, ולהתקדם כלפי מעלה



התקנת המוצר

כל התקנה, החלפה או טיפול במוצר זה חייבות להתבצע על ידי איש צוות מיומן ומוסמך בלבד.



השלכה לאשפה בתום השימוש

השלכת המוצר בתום השימוש חייבת להיעשות בהתאם לכל התקנות והחוקים המקומיים.



תקנות חשמל מקומיות

יש להתקין מערכת זו בהתאם לתקנות החשמל המקומיות.



כבל אספקת חשמל

על מנת לחבר את המוצר לחשמל בצפון אמריקה, יש לבחור כבל חשמלי ובעל הסמכת CSA, מוליך - 3 [16 AWG], שבקצהו תקע מובנה 125V, 13A. אורכו המינימלי 1.5 מטר (6 אינץ') ואורכו המקסימלי 4.5 מטר.

לחיבור אירופאי, בחר כבל חשמלי בעל התאמה בינלאומית וסימון "HAR", מוליך 3-גידים פנימיים באורך מינימלי של 1.0 מילימטר² 300V עם עטיפת PVC מבודדת. על הכבל לכלול תקע מובנה 250V, 10A.



תקנות התקנה

יש להתקין מערכת זו על פי הגרסה האחרונה של תקנות החשמל המקומיות הנהוגות במדינה. עבור צפון אמריקה, יש להתקין את המערכת בהתאם לתקנות החשמל הלאומיות המיושמות בארה"ב ובקנדה



חיבור בין מערכות

על כבלים לחיבור היחידה לממשקי Ethernet ו-RS232 להיות בעלי הסמכת UL מסוג DP-2 או DP-1 (כאשר הם מצויים במעגל חשמלי שאינו מקור כוח מוגבל).



הגנה מפני מתח גבוה

יש להקפיד על המצאותם בבניין ועל זמינותם של אמצעים להגנה מפני מתח גבוה בתקן 20A.



אין להשתמש במערכת כמדף או כשטח עבודה

זהירות: אין להשתמש בצידוד כמדף או כשטח עבודה. המסילות לא נועדו לשליפת המערכת מהארון, אלא להתקנת המערכת במקומה הקבוע והסופי בארון



WEEE תקנת

על פי תקנות WEEE 2002/96/EC, יש להשליך את כל פסולת הציוד החשמלי והאלקטרוני בנפרד מפסולת ביתית רגילה. בתום השימוש, השלך. לאשפה את המוצר הזה ואת כל חלקיו באופן אחראי וידידותי לסביבה



מגבלות חשמליות בנורבגיה

בנורבגיה בלבד, יחידה זו מיועדת לחיבור למערכת אספקת חשמל מסוג TN, ולמערכת אספקת חשמל מסוג IT.

Document Revision History

Revision	Date	Description
1.4	Sep 21, 2023	Updated the RS232 cable type to DB9-to-DB9 in Hardware Overview and Configuring Appliance
1.3	Jul 19, 2023	Updated Hardware Overview
1.2	Feb 23, 2023	<ul style="list-style-type: none">• Updated Technical Specifications
1.1	Dec 20, 2022	<ul style="list-style-type: none">• Added Field Replaceable Units• Added a warning under Configuring the Appliance
1.0	Nov 30, 2022	First release

Notice

This document is provided for information purposes only and shall not be regarded as a warranty of a certain functionality, condition, or quality of a product. Neither NVIDIA Corporation nor any of its direct or indirect subsidiaries and affiliates (collectively: "NVIDIA") make any representations or warranties, expressed or implied, as to the accuracy or completeness of the information contained in this document and assumes no responsibility for any errors contained herein. NVIDIA shall have no liability for the consequences or use of such information or for any infringement of patents or other rights of third parties that may result from its use. This document is not a commitment to develop, release, or deliver any Material (defined below), code, or functionality.

NVIDIA reserves the right to make corrections, modifications, enhancements, improvements, and any other changes to this document, at any time without notice. Customer should obtain the latest relevant information before placing orders and should verify that such information is current and complete.

NVIDIA products are sold subject to the NVIDIA standard terms and conditions of sale supplied at the time of order acknowledgement, unless otherwise agreed in an individual sales agreement signed by authorized representatives of NVIDIA and customer ("Terms of Sale"). NVIDIA hereby expressly objects to applying any customer general terms and conditions with regards to the purchase of the NVIDIA product referenced in this document. No contractual obligations are formed either directly or indirectly by this document.

NVIDIA products are not designed, authorized, or warranted to be suitable for use in medical, military, aircraft, space, or life support equipment, nor in applications where failure or malfunction of the NVIDIA product can reasonably be expected to result in personal injury, death, or property or environmental damage. NVIDIA accepts no liability for inclusion and/or use of NVIDIA products in such equipment or applications and therefore such inclusion and/or use is at customer's own risk.

NVIDIA makes no representation or warranty that products based on this document will be suitable for any specified use. Testing of all parameters of each product is not necessarily performed by NVIDIA. It is customer's sole responsibility to evaluate and determine the applicability of any information contained in this document, ensure the product is suitable and fit for the application planned by customer, and perform the necessary testing for the application in order to avoid a default of the application or the product. Weaknesses in customer's product designs may affect the quality and reliability of the NVIDIA product and may result in additional or different conditions and/or requirements beyond those contained in this document. NVIDIA accepts no liability related to any default, damage, costs, or problem which may be based on or attributable to: (i) the use of the NVIDIA product in any manner that is contrary to this document or (ii) customer product designs.

No license, either expressed or implied, is granted under any NVIDIA patent right, copyright, or other NVIDIA intellectual property right under this document. Information published by NVIDIA regarding third-party products or services does not constitute a license from NVIDIA to use such products or services or a warranty or endorsement thereof. Use of such information may require a license from a third party under the patents or other intellectual property rights of the third party, or a license from NVIDIA under the patents or other intellectual property rights of NVIDIA.

Reproduction of information in this document is permissible only if approved in advance by NVIDIA in writing, reproduced without alteration and in full compliance with all applicable export laws and regulations, and accompanied by all associated conditions, limitations, and notices.

THIS DOCUMENT AND ALL NVIDIA DESIGN SPECIFICATIONS, REFERENCE BOARDS, FILES, DRAWINGS, DIAGNOSTICS, LISTS, AND OTHER DOCUMENTS (TOGETHER AND SEPARATELY, "MATERIALS") ARE BEING PROVIDED "AS IS." NVIDIA MAKES NO WARRANTIES, EXPRESSED, IMPLIED, STATUTORY, OR OTHERWISE WITH RESPECT TO THE MATERIALS, AND EXPRESSLY DISCLAIMS ALL IMPLIED WARRANTIES OF NONINFRINGEMENT, MERCHANTABILITY, AND FITNESS FOR A PARTICULAR PURPOSE. TO THE EXTENT NOT PROHIBITED BY LAW, IN NO EVENT WILL NVIDIA BE LIABLE FOR ANY DAMAGES, INCLUDING WITHOUT LIMITATION ANY DIRECT, INDIRECT, SPECIAL, INCIDENTAL, PUNITIVE, OR CONSEQUENTIAL DAMAGES, HOWEVER CAUSED AND REGARDLESS OF THE THEORY OF LIABILITY, ARISING OUT OF ANY USE OF THIS DOCUMENT, EVEN IF NVIDIA HAS BEEN ADVISED OF THE POSSIBILITY OF SUCH DAMAGES. Notwithstanding any damages that customer might incur for any reason whatsoever, NVIDIA's aggregate and cumulative liability towards customer for the products described herein shall be limited in accordance with the Terms of Sale for the product.

Trademarks

NVIDIA, the NVIDIA logo, and Mellanox are trademarks and/or registered trademarks of NVIDIA Corporation and/or Mellanox Technologies Ltd. in the U.S. and in other countries. Other company and product names may be trademarks of the respective companies with which they are associated.



Copyright

© 2023 NVIDIA Corporation & affiliates. All Rights Reserved.

