



NVIDIA UFM Enterprise User Manual

v6.18.0

Table of Contents

1	Release Notes.....	21
1.1	Key Features.....	21
1.2	Changes and New Features.....	21
1.2.1	Unsupported Functionalities/Features.....	23
1.3	Installation Notes.....	24
1.3.1	Supported Devices.....	24
1.3.1.1	Supported NVIDIA Externally Managed Switches.....	24
1.3.1.2	Supported NVIDIA Internally Managed Switches.....	24
1.3.2	System Requirements.....	24
1.3.2.1	Bare Metal Deployment Requirements.....	25
1.3.2.2	Docker Installation Requirements.....	25
1.3.2.3	UFM Server Resource Requirements per Cluster Size.....	26
1.3.2.4	UFM GUI Client Requirements.....	26
1.3.2.5	MFT Package Version.....	27
1.3.2.6	UFM SM Version.....	27
1.3.2.7	UFM NVIDIA SHARP Software Version.....	27
1.3.2.8	Used Ports by UFM Server.....	27
1.3.3	Software Update from Prior Versions.....	27
1.4	Bug Fixes in This Release.....	28
1.5	Known Issues in This Release.....	28
1.6	Changes and New Features History.....	29
1.7	Bug Fixes History.....	35
1.8	Known Issues History.....	39
2	UFM Overview.....	45
2.1	Scale-Out Your Fabric with Unified Fabric Manager.....	45
2.2	UFM Benefits.....	46
2.3	Main Functionality Modules.....	47
2.4	UFM Communication Requirements.....	48
2.4.1	UFM Server Communication with Clients.....	48
2.4.1.1	UFM Server Communication with UFM Web UI Client.....	48
2.4.1.2	UFM Server Communication with SNMP Trap Managers.....	49
2.4.1.3	Summary of UFM Server Communication with Clients.....	49
2.4.2	UFM Server Communication with InfiniBand Switches.....	49
2.4.2.1	UFM Server InfiniBand Communication with Switch.....	49

2.4.2.2	UFM Server Communication with Switch Management Software (Optional)	49
2.4.2.3	UFM Server Communication with Externally Managed Switches (Optional)	50
2.4.2.4	Summary of UFM Server Communication with InfiniBand Switches ...	50
2.4.3	UFM Server Communication with InfiniBand Hosts	50
2.4.3.1	UFM Server InfiniBand Communication with HCAs.....	51
2.4.3.2	UFM Server Communication with InfiniBand Hosts	51
2.4.4	UFM Server High Availability (HA) Active–Standby Communication	51
2.4.4.1	UFM Server HA Active–Standby Communication	52
2.5	UFM Software Architecture	52
2.5.1	Graphical User Interface.....	53
2.5.2	Client Tier API	53
2.5.3	Client Tier SDK Tools	53
2.5.4	UFM Server	53
2.5.5	Subnet Manager	53
2.5.6	NVIDIA Scalable Hierarchical Aggregation and Reduction Protocol (SHARP)™ Aggregation Manager	53
2.5.7	Performance Manager	53
2.5.8	Device Manager	54
2.5.9	UFM Switch Agent	54
2.5.10	Communication Protocols.....	54
2.6	Getting Familiar with UFM's Data Model	54
2.6.1	UFM Model Basics	54
2.6.2	Physical Model.....	54
2.7	UFM Web UI Overview	55
2.7.1	Access the WebUI	55
2.7.1.1	UFM Web UI Supported Browsers	55
2.7.1.2	Launching UFM Web UI Session	55
2.7.2	WebUI Layout.....	56
2.7.2.1	Top Bar	57
2.7.2.2	Sidebar Menu	57
2.7.3	Set User Preferences	58
2.7.3.1	Dark/Light Theme	58
2.7.3.2	Time Zone Converter.....	59
2.7.3.3	Table Enhancements.....	60
2.7.3.3.1	Look and Feel Improvements	60
2.7.3.3.2	Displayed Columns.....	60

2.7.3.4	Export All Data as CSV.....	61
3	UFM Installation and Initial Configuration	62
3.1	Prerequisites for UFM Server Software Installation.....	62
3.2	UFM Installation Steps.....	62
3.3	UFM Installation Steps.....	62
3.3.1	Downloading UFM Software and License File	62
3.3.1.1	Obtaining License	62
3.3.1.2	Downloading UFM Software	64
3.3.2	Installing UFM Server Software	65
3.3.2.1	Prerequisites for UFM Server Software Installation.....	66
3.3.2.2	Additional Prerequisites for UFM High Availability Installation	68
3.3.2.3	Installing UFM Server on Bare Metal Server	68
3.3.2.3.1	Installing UFM on Bare Metal Server - High Availability Mode	69
3.3.2.3.2	Installing UFM on Bare Metal Server- Standalone Mode.....	72
3.3.2.4	Installing UFM Docker Container Mode	73
3.3.2.4.1	General Prerequisites	73
3.3.2.4.2	Prerequisites for Upgrading UFM Docker Container	73
3.3.2.4.3	Step 1: Loading UFM Docker Image	73
3.3.2.4.4	Step 2: Installing UFM Docker	74
3.3.2.4.5	Installation Modes	74
3.3.2.4.6	Installing UFM on Docker Container - High Availability Mode	75
3.3.2.4.7	Installing UFM on Docker Container - Standalone Mode	78
3.3.2.5	Replacing the Standby Node in HA Mode	79
3.3.2.5.1	Replacing the Standby Node	79
3.4	Activating Software License.....	79
3.4.1	Licensing	79
3.5	UFM Configuration	82
3.5.1	Initial Configuration	82
3.5.1.1	Configuring Fabric Interface	82
3.5.2	Optional Configurations.....	83
3.5.2.1	General Settings in gv.cfg	83
3.5.2.1.1	Enabling SHARP Aggregation Manager	83
3.5.2.1.2	Enabling Predefined Groups	83
3.5.2.1.3	Enabling Multi-NIC Host Grouping	83
3.5.2.1.4	Defining Node Description Black-List	84
3.5.2.1.5	Running UFM Over IPv6 Network Protocol.....	84
3.5.2.1.6	Adding SM Plugin (e.g. lossymgr) to event_plugin_name Option	84
3.5.2.1.7	Multi-port SM	85
3.5.2.1.8	Configuring UDP Buffer	85

3.5.2.1.9	Virtualization	85
3.5.2.1.10	Static SM LID	85
3.5.2.1.11	Configuring Log Rotation.....	86
3.5.2.1.12	Configuring UFM Logging.....	86
3.5.2.1.13	Configuring UFM Over Static IPv4 Address	87
3.5.2.1.14	Configuring Syslog	88
3.5.2.1.15	Excluding Unhealthy Ports from Fabric Health Report	89
3.5.2.1.16	Configuration Examples in gv.cfg.....	90
3.5.2.1.17	Managing Dynamic Telemetry	92
3.5.2.1.18	SM Trap Handler Configuration	92
3.5.2.1.19	Setting CPU Affinity on UFM.....	93
3.5.2.1.20	Quality of Service (QoS) Support	93
3.5.2.1.21	UFM Failover to Another Port	94
3.5.2.1.22	Configuring Managed Switches Info Persistency.....	95
3.5.2.1.23	Configuring Partial Switch ASIC Failure Events	95
3.5.2.1.24	Enabling Network Fast Recovery	95
3.5.2.1.25	Disabling Rest Roles Access Control	96
3.5.2.1.26	Enabling/Disabling Authentication	97
3.5.2.1.27	UFM Configuration Files Based on Fabric Size	98
3.5.2.2	Setting up Telemetry in UFM.....	100
3.5.2.2.1	Enabling UFM Telemetry	100
3.5.2.2.2	Changing UFM Telemetry Default Configuration	100
3.5.2.2.3	Supporting Generic Counters Parsing and Display	101
3.5.2.2.4	Supporting Multiple Telemetry Instances Fetch	101
3.5.2.2.5	Low-Frequency (Secondary) Telemetry.....	102
3.6	Running UFM Server Software	104
3.6.1	Running UFM Server Software in Management Mode	105
3.6.2	Running UFM Software in High Availability Mode.....	105
3.6.3	HTTP/HTTPS Configuration.....	105
3.6.4	UFM Internal Web Server Configuration	106
3.6.5	User Authentication	106
3.6.6	UFM Authentication Server	106
3.6.6.1	Configurations of the UFM Authentication Server.....	106
3.6.7	Azure AD Authentication	107
3.6.7.1	Register UFM in Azure AD Portal	107
3.6.7.2	Enable Azure Authentication From UFM	111
3.6.7.3	Azure Authentication Login Page	111
3.6.7.4	Kerberos Authentication	112
3.6.7.4.1	Setting Up Kerberos Server Machine	112
3.6.7.4.2	Setting Up Kerberos Client Machine.....	113

3.6.8	Licensing	114
3.6.9	Showing UFM Processes Status	114
3.7	Upgrading UFM Software.....	115
3.7.1	Upgrading UFM on Bare Metal Server	115
3.7.1.1	Upgrading UFM on Bare Metal - Standalone Server Upgrade	115
3.7.1.2	Upgrading UFM on Bare Metal - High Availability Upgrade	116
3.7.2	Upgrading UFM on Docker Container.....	118
3.7.2.1	Upgrading UFM on Docker Container in Standalone Mode	118
3.7.2.2	Upgrading UFM Container in High Availability Mode	118
3.8	Uninstalling UFM	119
3.8.1	Uninstalling UFM in Standalone Mode.....	119
3.8.2	Uninstalling UFM in High Availability	120
3.8.3	Uninstalling UFM in Docker Deployment	120
3.9	UFM Configuration Backup and Restore	120
3.9.1	Overview	120
3.9.2	Backup UFM configuration	120
3.9.2.1	UFM (Bare Metal)	121
3.9.2.1.1	Optional Arguments.....	121
3.9.2.2	UFM Docker Container	121
3.9.2.3	UFM Appliance	121
3.9.3	Restore UFM Configuration	122
3.9.3.1	UFM Bare Metal	122
3.9.3.1.1	Optional Arguments.....	122
3.9.3.2	UFM Docker Container	122
3.9.3.3	UFM Appliance	122
3.10	UFM Factory Reset	123
3.10.1	UFM Docker Container Factory Reset	123
3.10.2	UFM Enterprise Factory Reset.....	124
4	Manage Users	126
4.1	Accounts and Roles	126
4.2	User Account Management	126
4.2.1	Add New User.....	127
4.2.2	Edit/Remove Existing User	127
4.3	Authentication Methods.....	128
4.3.1	UFM Authentication Server	129
4.3.1.1	Configurations of the UFM Authentication Server.....	129

4.3.2	Token-Based Authentication.....	130
4.3.3	Proxy Authentication	131
4.3.3.1	Delegating Authentication to a Proxy.....	131
4.3.4	Azure AD Authentication.....	131
4.3.4.1	Register UFM in Azure AD Portal	131
4.3.4.2	Enable Azure Authentication From UFM.....	136
4.3.4.3	Azure Authentication Login Page	136
4.3.5	Kerberos Authentication	137
4.3.5.1	Setting Up Kerberos Server Machine	137
4.3.5.2	Setting Up Kerberos Client Machine.....	138
5	UFM Server Health Monitoring	140
5.1	UFM Health Configuration	140
5.1.1	UFM Core Files Tracking.....	143
5.2	Example of Health Configuration.....	143
5.2.1	Event Burst Management	144
6	Events and Alarms	145
6.1	Threshold-Crossing Events Reference.....	146
7	Reports	158
8	Telemetry2.....	159
8.1	Historical Telemetry Collection in UFM.....	160
8.1.1	Storage Considerations.....	160
8.2	High-Frequency (Primary) Telemetry Fields	160
8.3	Low-Frequency (Secondary) Telemetry Fields.....	162
9	UFM Web UI	167
9.1	Fabric Dashboard	167
9.1.1	Dashboard Views and Panel Management	167
9.1.2	Dashboard Timeline Snapshots.....	168
9.1.3	Dashboard Panels	169
9.1.4	Top N Servers/Switches by Rx or Tx Bandwidth.....	169
9.1.5	Top N Congested Servers/Switches by Rx/Tx Bandwidth	173
9.1.6	Top N Utilized PKeys.....	176
9.1.7	Top N Alarmed Servers/Switches	177
9.1.8	Inventory Summary	181
9.1.9	Fabric Utilization	182
9.1.10	Recent Activities	183

9.1.11	Traffic Map	185
9.1.11.1	Network Traffic Map	185
9.1.11.2	Levels Network Traffic Map	188
9.1.11.3	Port Group Traffic Map	191
9.1.11.4	Traffic Map Bar Chart.....	191
9.1.12	Events History	192
9.2	Network Map.....	194
9.2.1	Network Map Components	194
9.2.2	Selecting Map Elements.....	195
9.2.3	Map Information and Settings.....	196
9.2.4	Map View Tab	199
9.2.5	Map Zoom In Tab	199
9.2.6	Map Layouts.....	201
9.2.7	Information View Tab.....	203
9.2.8	Link Analysis	204
9.2.9	Topology Compare	209
9.2.10	Properties Tab	211
9.2.11	Network Map Elements Actions	212
9.2.11.1	Supported Actions for Internally Managed Switches.....	213
9.2.11.2	Supported Actions for Externally Managed Switches	214
9.2.11.3	Supported Actions for Hosts	215
9.3	Managed Elements.....	215
9.3.1	Devices Window	216
9.3.1.1	Mark Device as Unhealthy	218
9.3.1.2	Mark Device as Healthy	219
9.3.1.3	Upgrading Software and Firmware for Hosts and Externally Managed Switches	220
9.3.1.3.1	Software/Firmware Upgrade via FTP	220
9.3.1.3.2	In-Band Firmware Upgrade	221
9.3.1.3.3	Directory Structure for Software or Firmware Upgrade Over FTP ...	221
9.3.1.3.4	PSID and Firmware Version In-Band Discovery.....	221
9.3.1.3.5	Switch Management IP Address Discovery.....	222
9.3.1.3.6	Upgrading Server Software	222
9.3.1.3.7	Upgrading Firmware	223
9.3.1.3.8	Upgrade Cables Transceivers Firmware Version.....	223
9.3.1.4	Device Information Tabs	228
9.3.1.4.1	General Tab	228
9.3.1.4.2	Ports Tab	229

9.3.1.4.3	Cables Tab.....	230
9.3.1.4.4	Groups Tab	231
9.3.1.4.5	Alarms Tab	232
9.3.1.4.6	Events Tab.....	233
9.3.1.4.7	Inventory Tab	234
9.3.1.4.8	HCA's Tab	235
9.3.1.4.9	Device Access Tab.....	236
9.3.1.4.10	Virtual Networking Tab.....	238
9.3.2	Ports Window	239
9.3.2.1	Physical Grade and Eye Opening Information	242
9.3.2.2	Auto-isolation of High-BER Ports	242
9.3.3	Virtual Ports Window	243
9.3.4	Unhealthy Ports Window.....	244
9.3.4.1	Unhealthy Port Connectivity Filter.....	246
9.3.4.2	Health Policy Management	246
9.3.5	Cables Window	247
9.3.6	Groups Window.....	247
9.3.7	Inventory Window.....	250
9.3.8	PKeys Window	250
9.3.8.1	Creating New PKey	250
9.3.8.2	PKey Members Tab	252
9.3.8.3	PKey QoS Tab	252
9.3.8.4	PKey Actions	253
9.3.8.5	Support Pkey with Virtual Ports	253
9.3.9	HCA's Window	255
9.4	Events & Alarms	255
9.4.1	Device Status Events	256
9.4.2	Link Status Events	257
9.4.2.1	Cable Transceiver Temperatures.....	259
9.4.2.1.1	GUI Views	259
9.4.2.2	Topology Compare Events:	260
9.5	Telemetry - User-Defined Sessions	260
9.6	System Health	260
9.6.1	UFM Health Tab.....	260
9.6.2	UFM Logs Tab	262
9.6.2.1	Event Logs.....	263
9.6.2.2	Subnet Manager (SM) Logs.....	263
9.6.2.3	UFM Logs	263

9.6.3	UFM System Dump Tab	264
9.6.4	Fabric Health Tab	265
9.6.4.1	Custom Reports	265
9.6.4.2	Periodic Reports.....	269
9.6.5	Daily Reports Tab.....	270
9.6.5.1	Activating and Deactivating the Daily Report	270
9.6.5.2	Saving Daily Reports	271
9.6.5.3	Other Daily Report Configurations	271
9.6.5.4	Report Content	272
9.6.5.4.1	Sidebar	272
9.6.5.4.2	Daily Report Highlights.....	273
9.6.5.4.3	Available Charts.....	274
9.6.5.4.4	Daily Report View in the Web UI.....	281
9.6.6	Topology Compare Tab	284
9.6.6.1	Overview	284
9.6.6.1.1	Periodic Comparison.....	284
9.6.6.1.2	Custom Comparison	285
9.6.6.2	Topology Comparison Flow	286
9.6.7	Fabric Validation Tab	287
9.6.8	IBDiagnet Tab	290
9.7	Jobs	294
9.8	Settings.....	295
9.8.1	Events Policy.....	295
9.8.1.1	Events Policy Simulation	297
9.8.1.2	SNMP Settings.....	297
9.8.1.3	Configuring Email-on-Events	298
9.8.2	Device Access.....	300
9.8.3	Network Management	301
9.8.3.1	UFM Routing Protocols	301
9.8.3.2	Configuring Routing Protocol.....	302
9.8.4	Subnet Manager Tab	303
9.8.4.1	SM Keys Configuration.....	303
9.8.4.2	SM Limits Configuration.....	304
9.8.4.3	SM Lossy Manager Configuration.....	306
9.8.4.4	SM SL2VL Mapping Configuration	306
9.8.4.5	SM Sweep Configuration	307
9.8.4.6	SM Handover Configuration.....	308
9.8.4.7	SM Threading Configuration	309
9.8.4.8	SM Logging Configuration	309

9.8.4.9	SM Miscellaneous Settings	310
9.8.4.10	SM QoS Configuration.....	311
9.8.4.11	SM Congestion Control Configuration	312
9.8.4.12	SM Adaptive Routing Configuration.....	313
9.8.5	Non-Optimal Links	314
9.8.6	User Management Tab.....	315
9.8.7	Email.....	317
9.8.8	Remote Location	319
9.8.9	Data Streaming	320
9.8.10	Topology Compare	321
9.8.11	Token-based Authentication.....	322
9.8.12	Plugin Management.....	323
9.8.13	Rest Roles Access Control.....	328
9.8.13.1	Adding a New Role	329
9.8.13.2	Updating Custom Roles.....	331
9.8.13.3	Deleting Custom Roles	331
9.8.13.4	Creating a User with a Custom Role	332
9.8.14	User Preferences.....	333
10	Multi-Subnet UFM	334
10.1	Overview	334
10.2	Setting Up Multi-Subnet UFM.....	334
10.3	Functionality.....	334
11	UFM Plugins	348
11.1	UFM Plugins Management.....	348
11.1.1	UFM Plugin Management Using themanage_ufm_plugins.sh Script.....	348
11.2	UFM Plugins	349
11.3	Plugins Bundle	350
11.4	REST-RDMA Plugin	350
11.4.1	Deployment Server	351
11.4.1.1	Deploy Plugin on UFM Appliance.....	351
11.4.1.2	Deploy Plugin on Bare Metal Server.....	351
11.4.1.3	Deployment Client.....	351
11.4.2	How to Run.....	352
11.4.2.1	Server	352
11.4.2.2	Client	352
11.4.3	Authentication Configuration	353
11.4.3.1	Remote ibdiagnet Request.....	353

11.4.3.2	Authenticated Remote ibdiagnet Request	353
11.4.3.3	Rest Request with Username/Password Authentication.....	354
11.4.3.4	Rest Request with Client Certificate Authentication	354
11.4.3.5	Rest Request with Token Authentication	355
11.5	NDT Plugin	355
11.5.1	Overview	355
11.5.2	Deployment.....	355
11.5.3	Authentication	356
11.5.4	REST API	356
11.5.4.1	Topodiff.....	356
11.5.4.2	Subnet Merger	356
11.5.5	NDT Format - Topodiff	356
11.5.5.1	Switch to Switch NDT	357
11.5.5.2	Switch to Host NDT	357
11.5.5.3	Other.....	358
11.5.6	NDT Format - Subnet Merger.....	359
11.5.6.1	Functionality.....	359
11.5.6.2	Subnet Merger Flow	360
11.5.6.3	Subnet Merger UI.....	361
11.5.6.4	Extending the InfiniBand Setup via Subnet Merger	365
11.6	UFM Telemetry Fluentd Streaming (TFS) Plugin.....	366
11.6.1	Overview	366
11.6.2	Deployment.....	366
11.6.3	Authentication	366
11.6.4	Rest API.....	366
11.7	UFM Events Fluent Streaming (EFS) Plugin.....	367
11.7.1	Overview	367
11.7.2	Deployment.....	367
11.7.3	Authentication	367
11.7.4	Rest API.....	367
11.8	UFM Bright Cluster Integration Plugin	368
11.8.1	Overview	368
11.8.2	Deployment.....	368
11.8.3	Authentication	368
11.8.4	Bright Cluster Integration UI	368
11.8.5	Rest API.....	370

11.9	UFM Cyber-AI Plugin	370
11.9.1	Overview	370
11.9.2	Deployment	370
11.10	Autonomous Link Maintenance (ALM) Plugin.....	372
11.10.1	Overview	372
11.10.2	Schematic Flow	373
11.10.3	Deployment	373
11.10.4	Data Collection	374
11.10.5	ALM Configuration	375
11.10.6	ALM UI	377
11.10.6.1	Current State	377
11.10.6.2	Events Summary.....	378
11.10.6.3	Port Level Status	379
11.10.6.4	Configuration	379
11.10.7	ALM Jobs	381
11.11	ClusterMinder Plugin	382
11.11.1	Overview	382
11.11.2	Deployment	382
11.11.3	ClusterMinder Plugin UI	383
11.11.3.1	Example of Adding Data Source.....	383
11.11.3.2	Example of Adding the Redfish Host	383
11.11.3.3	Example of Removing Data Source	384
11.12	GRPC-Streamer Plugin.....	385
11.12.1	Authentication	385
11.12.2	Create a Session to UFM from GRPC	385
11.12.3	Create New Subscription.....	386
11.12.4	Edit Known Subscription	387
11.12.5	Get List of Known Subscribers	387
11.12.6	Delete a Known Subscriber	387
11.12.7	Run a Known Subscriber Once.....	388
11.12.8	Run Streamed Data of a Known Subscriber	388
11.12.9	Run a New Subscriber Once	389
11.12.10	Run New Subscriber Streamed Data.....	390
11.12.11	Run A Serialization on All the Running Streams	390
11.12.12	Stop a Running Stream	390

11.12.13	Run a subscribe stream	391
11.12.14	Get the variables from a known subscriber.....	391
11.12.14.1	Get Help / Version.....	391
11.13	Sysinfo Plugin	392
11.13.1	Overview	392
11.13.2	Deployment	392
11.13.3	REST API	392
11.13.4	Sysinfo Query Format	392
11.14	SNMP Plugin.....	393
11.14.1	Deployment.....	393
11.14.2	Authentication	393
11.14.3	REST API	393
11.14.4	Usage	394
11.14.5	Other.....	396
11.15	Packet Level Monitoring Collector (PMC) Plugin	396
11.15.1	Overview	396
11.15.1.1	pFRN	396
11.15.1.2	Fast Recovery.....	396
11.15.1.3	PHY Error Links.....	397
11.15.1.4	CQE.....	397
11.15.1.5	Congestion	397
11.15.2	Deployment.....	397
11.15.2.1	Installation.....	397
11.15.3	PMC UI	398
11.15.3.1	Network Event Collector Display	398
11.15.3.2	Network Event Collector Configuration	399
11.16	PDR Deterministic Plugin	399
11.16.1	Overview	399
11.16.2	Schematic Flow	400
11.16.3	Deployment.....	400
11.16.4	Isolation Decisions	401
11.16.4.1	NDR Link Validation Procedure.....	401
11.16.4.2	Return to Service	402
11.16.4.3	Configuration	402
11.16.4.4	Calculating BER Counters.....	402
11.16.4.5	Ports Exclusion List	403
11.17	GNMI-Telemetry Plugin.....	404

11.17.1	Deployment	404
11.17.2	Authentication	404
11.17.3	Secure Server	405
11.17.4	Supported API Requests	405
11.17.4.1	Capability Request	405
11.17.4.2	Supported Paths	406
11.17.4.2.1	Telemetry Request Path Construction	406
11.17.4.2.2	Other Information Requests (Events, Inventory)	406
11.17.4.2.3	Switch Rank Information Path Construction	406
11.17.4.2.4	Additional Configurations	406
11.17.4.3	Telemetry Messages - Data Format	407
11.17.5	Get Request	407
11.17.5.1	Subscribe Stream Request	408
11.17.5.2	Subscribe On-Change Request	409
11.17.6	Inventory Requests	411
11.17.7	Events Requests	411
11.17.8	Switch Rank Requests	412
11.18	UFM Telemetry Manager (UTM) Plugin	412
11.18.1	Overview	412
11.18.2	Deployment	413
11.18.2.1	UTM Deployment Scripts	413
11.18.2.1.1	Hostlist File	414
11.18.2.1.2	Main Deployment Script	415
11.18.2.2	UFM Plugin Mode	415
11.18.2.2.1	Default UFM Telemetry Monitoring	417
11.18.2.3	Standalone Mode	417
11.18.2.4	Manual Deployment	418
11.18.2.4.1	UTM Deployment	418
11.18.2.4.2	Managed/Standalone TIs Manual deployment	418
11.18.2.5	UTM Configuration File	419
11.18.2.5.1	Distributed Telemetry	419
11.18.3	GUI	419
11.18.3.1	TI Management	420
11.18.3.2	Telemetry Status Fields	420
11.18.4	REST API	421
11.18.4.1	Accessing UTM API Commands Based on Operating Mode	421
11.18.4.2	Command List	421
11.19	UFM Consumer Plugin	423

11.19.1	Overview	423
11.20	Fast-API Plugin	424
11.20.1	Overview	424
11.20.2	Deployment	424
11.20.3	SequencDiagrm	425
11.20.4	Sequence Diagram	426
11.20.5	Supported APIs	426
11.21	UFM Light Plugin	428
11.21.1	Overview	428
11.21.2	Deployment	428
11.21.2.1	Prerequisites	428
11.21.2.2	Installation	429
11.21.2.3	Configuration	429
11.21.2.4	Configuration Options:	429
11.21.3	Supported REST API	429
11.21.4	Troubleshooting	430
11.22	Key Performance Indexes (KPI) Plugin	430
11.22.1	KPIs	430
11.22.1.1	NICs Connectivity	430
11.22.1.2	Link Stability	431
11.22.1.3	Overheated Components	431
11.22.1.4	Bandwidth Loss due to Congestion	431
11.22.1.5	Fat Tree (Single Root) to Tree Conversion	431
11.22.1.6	Top-of-rack (ToR) to ToR Max Flow (Bandwidth) Matrix	433
11.22.2	Deployment	435
11.22.2.1	Deploy the KPI as a UFM plugin	435
11.22.2.2	Deploy the KPI as a Standalone application	435
11.22.3	Configurations	435
11.22.3.1	Clusters Configurations	436
11.22.3.2	KPI Configurations	437
11.22.3.3	Prometheus Configurations	437
11.22.3.4	Global Time Interval Configurations	437
11.22.3.5	Logs Configurations	438
11.22.3.6	Grafana Dashboard Templates	438
11.22.4	Logs	438
11.22.5	REST APIs	439
11.22.5.1	Get List of Configured Clusters	439
11.22.5.2	Get KPIs Information	439

11.22.5.3	Get KPIs Values	439
11.22.5.4	Get KPI Plugin Overview	440
11.22.6	UI Views	441
11.22.6.1	KPI Overview.....	441
11.22.6.2	Cluster KPIs Data.....	442
12	Troubleshooting	443
12.1	Split-Brain Recovery in HA Installation	443
12.2	Performing Failover on Non-Master Node	443
12.3	Restoring UFM Data Upon In-Service Upgrade Failure.....	444
13	Appendixes.....	445
13.1	SM Configurations	445
13.1.1	Appendix - SM Default Files	445
13.1.2	Appendix - UFM Subnet Manager Default Properties	445
13.1.2.1	Configuring UFM for SR-IOV	453
13.1.2.2	Isolating Switch From Routing	454
13.1.3	Appendix - Partitioning	454
13.1.3.1	SM Partitions.conf File Format.....	455
13.1.4	Appendix - Enhanced Quality of Service	457
13.1.4.1	Enhanced QoS Policy File	457
13.1.4.1.1	Notes.....	458
13.1.4.1.2	Policy File Example	458
13.1.5	Appendix - OpenSM Configuration Files for Congestion Control	458
13.1.5.1	OpenSM Configuration.....	458
13.1.5.1.1	Enabling Congestion Control	458
13.1.5.1.2	Defining a Congestion Control Policy File	459
13.1.5.1.3	Defining a directory for PPCC algorithm profiles	459
13.1.6	Appendix - Routing Chains.....	459
13.1.6.1	Configuring Routing Chains	459
13.1.6.1.1	Defining Port Groups	460
13.1.6.1.2	Defining Port Group Policy File	460
13.1.6.1.3	Configuring Port Group Policy.....	460
13.1.6.1.4	Port Group Qualifiers.....	460
13.1.6.1.5	Rule Qualifiers.....	460
13.1.6.1.6	Predefined Port Groups	462
13.1.6.1.7	Port Groups Policy Examples	462
13.1.6.2	Defining Topologies Policy File.....	463
13.1.6.2.1	Configuring Topology Policy	463
13.1.6.2.2	Topology Qualifiers	463
13.1.6.3	Configuration File per Routing Engine	463

13.1.6.3.1	Defining Routing Chain Policy File.....	464
13.1.6.3.2	First Routing Engine in Chain.....	464
13.1.6.3.3	Configuring Routing Chains Policy	464
13.1.6.3.4	Routing Engine Qualifiers	464
13.1.6.3.5	Dump Files per Routing Engine	465
13.1.7	Appendix - Adaptive Routing	466
13.1.8	Appendix - Security Features	466
13.1.8.1	SA Enhanced Trust Model (SAETM).....	466
13.1.8.1.1	Set of Untrusted SA Requests Allowed	467
13.1.8.1.2	Proxy SA Requests.....	467
13.1.8.1.3	Registration Limits.....	468
13.1.8.1.4	SAETM Logging.....	468
13.1.8.2	SGID Spoofing.....	468
13.1.8.3	M_Key Authentication	469
13.1.8.3.1	M_Key Per Port	469
13.1.9	Appendix - SM Activity Report	469
13.1.9.1	SM Supported Activities	469
13.2	Appendix - Diagnostic Utilities.....	470
13.2.1	InfiniBand Diagnostics Commands	470
13.2.2	Diagnostic Tools	471
13.2.2.1	Dependencies.....	471
13.2.3	Utilities Descriptions	472
13.3	Appendix - Supported Port Counters and Events.....	486
13.3.1	InfiniBand Port Counters.....	486
13.3.2	Supported Traps and Events	488
13.4	Appendix - Used Ports	500
13.5	Appendix - Configuration Files Auditing	500
13.6	Appendix - IB Router	501
13.6.1	IB Router Scripts	502
13.6.1.1	set_num_of_subnets.sh	502
13.6.1.2	add_interfaces_to_subnet.sh	503
13.6.1.3	remove_interfaces_from_subnet.sh	503
13.6.1.4	add_subnet_to_router.sh	504
13.6.1.5	remove_subnet_from_router.sh	504
13.6.1.6	set_ufm_sm_router_support.sh.....	505
13.6.2	IB Router Configuration	505
13.7	Appendix - NVIDIA SHARP Integration.....	505

13.7.1	NVIDIA Scalable Hierarchical Aggregation and Reduction Protocol (SHARP)™	505
13.7.2	NVIDIA SHARP Aggregation Manager	506
13.7.2.1	NVIDIA SHARP AM Prerequisites	506
13.7.2.2	NVIDIA SHARP AM Configuration	507
13.7.3	Running NVIDIA SHARP AM in UFM	507
13.7.4	Operating NVIDIA SHARP AM with UFM.....	508
13.7.5	Monitoring NVIDIA SHARP AM by UFMHealth	509
13.7.6	Managing NVIDIA SHARP AM by UFM High Availability (HA)	509
13.7.7	NVIDIA SHARP AM Logs.....	509
13.7.8	NVIDIA SHARP AM Version	509
13.8	Appendix - UFM SLURM Integration	509
13.8.1	Prerequisites.....	509
13.8.2	Automatic Installation	509
13.8.3	Manual Installation	510
13.8.4	UFM SLURM Config File.....	510
13.8.5	Configuring UFM for NVIDIA SHARP Allocation	511
13.8.5.1	Generate token_auth.....	511
13.8.6	Prolog and Epilog.....	511
13.8.7	Integration Files.....	511
13.8.8	Running UFM-SLURM Integration.....	512
13.9	Appendix - Switch Grouping.....	513
13.9.1	UI Presentation	513
13.10	Appendix - Device Management Feature Support.....	517
14	Document Revision History	521
15	EULA, Legal Notices and 3rd Party Licenses	527
15.1	Legal Notice	527
15.2	Third-Party Licenses.....	527
15.3	License Agreement	527
15.3.1	Exhibit A.....	531

You can download a PDF version [here](#).

About This Document

NVIDIA® UFM® Enterprise is a powerful platform for managing InfiniBand scale-out computing environments. UFM enables data center operators to efficiently monitor and operate the entire fabric, boost application performance and maximize fabric resource utilization.

This user guide provides documentation for network administrators responsible for deploying, configuring, monitoring, and troubleshooting the network in their data center.

For a list of the new features, bug fixes and known issues in this release, see [Release Notes](#).

Software Download

To download the UFM software, please visit [NVIDIA's Licensing Portal](#).

If you do not have a valid license, please fill out the [NVIDIA Enterprise Account Registration](#) form to get a UFM evaluation license.

Document Revision History

For the list of changes made to this document, refer to [Document Revision History](#).

1 Release Notes

NVIDIA® UFM® is a powerful platform for managing InfiniBand scale-out computing environments. UFM enables data center operators to efficiently monitor and operate the entire fabric, boost application performance and maximize fabric resource utilization.

1.1 Key Features

UFM provides a central management console, including the following main features:

- Fabric dashboard including congestion detection and analysis
- Advanced real-time health and performance monitoring
- Fabric health reports
- Threshold-based alerts
- Fabric segmentation/isolation
- Quality of Service (QoS)
- Routing optimizations
- Central device management
- Task automation
- Logging
- High availability
- Daily report: Statistical information of the fabric during the last 24 hours
- Event management
- Switch auto-provisioning
- UFM-SDN Appliance in-service software upgrade
- Fabric validation tests
- Client certificate authentication
- IPv6 on management ports

Prior to installation, please verify that all prerequisites are met. Please refer to [System Requirements](#).

1.2 Changes and New Features

This section lists the new and changed features in this software version.

For an archive of changes and features from previous releases, please refer to [Changes and New Features History](#).

Feature	Description
UFM Reports Enhancements	Added an option for excluding unhealthy ports from UFM reports based on <code>ibdiagnet</code> (for example: Fabric Health report, Fabric Validation tests). For more information, refer to Excluding Unhealthy Ports .

Feature	Description	
Telemetry Enhancements	Added support for Egress Queue depth indications (as part of UFM secondary telemetry instance). For more information, refer to Exposing Performance Histogram Counters .	
	Added support for Extended Port VL Xmit Time Congestion counters (as part of UFM secondary telemetry instance).	
UFM Configuration Adjustments	Added the option for auto-setting of UFM configuration based on fabric size (large scale, small scale). For more information, refer to Adjusting UFM Configuration Files Based on Fabric Size .	
UFM Container Timezone	The UFM Container has been updated to operate in the host machine's time zone instead of UTC.	
UFM Events	Added the ability to update thresholds, severities, and durations (TTL) for selected UFM Events.	
	Added a new UFM event for indicating asymmetric Adaptive Routing (based on SM trap). For more information, refer to Appendix - Supported Port Counters and Events .	
Topology Changes Reports Enhancements	Enhanced the topology change indication from the master topology and enabled a quick drill-down to the associated topology change report. For more information, refer to Topology Compare Tab and Events & Alarms .	
Multi-Subnet UFM	Added support for running UFM Fabric validation Tests from UFM Multi-Subnet Consumer. For more information, refer to Multi-Subnet UFM .	
UFM Docker Container Deployment	Added support for deploying UFM as a docker on Oracle Linux 8. For more information, refer to Installation Notes .	
UFM-HA	HA Deployment: Added support for deploying UFM HA on Ubuntu24.04.	
	HA Configuration: Added configurable failover criteria (management interface loss-of-link).	
UFM System Dump Analyser	Introduced an internal debugging tool for more efficient analysis of UFM system dumps.	
Plugins	REST-RDMA Plugin	Added support for client certificate authentication when communicating between the client and the REST over RDMA plugin server.
	UFM Light Plugin	Added support for UFM Light Plugin to create a reduced UFM model and deliver a high-performance REST API.
	Key Performance Indexes (KPI) Plugin	Added support for the KPI plugin which periodically collects telemetry metrics and topology data from one or multiple UFM Telemetry and UFM clusters to calculate high-level Key Performance Indicators (KPIs).
	ClusterMind Plugin	Added support for the ClusterMind plugin which collects telemetry data from multiple data sources and aggregates, streams and visualizes the backend.
	Packet Mirroring Collector (PMC) Plugin	Added the option to collect PHY link-down event indications through fast-recovery notification channels.
	UFM Plugins Management	Added support for UFM plugin management using the <code>manage_ufm_plugins.sh</code> script.
	Plugins Bundle	Added support for a single deployment of plugins to extend functionalities of the UFM ecosystem.

Feature	Description	
REST APIs	UFM-Forge Integration	Added support for setting SM resource limitation. For more information, refer to the Physical-Virtual GUID Mapping REST API .
	SHARP Jobs Performance Analysis	Added a new REST API which expose SHARP Job statistics data. For more information, refer to NVIDIA SHARP REST API
	UFM Logging	Added caller (IP Address) and duration logging info for all REST API calls.
	UFM Version API Enhancement	Added a REST API to retrieve the versions of major UFM components and enabled plugins.

The items listed in the table below apply to all UFM license types.

For bare metal installation of UFM, it is required to install MLNX_OFED 5.X (or newer) before the UFM installation.

Please make sure to use the UFM installation package that is compatible with your setup, as detailed in [Bare Metal Deployment Requirements](#).

1.2.1 Unsupported Functionalities/Features

The following distributions are no longer supported in UFM:

- RH7.0-RH7.7 / CentOS7.0-CentOS7.7
- SLES12 / SLES 15
- EulerOS2.2 / EulerOS2.3

Deprecated Features:

- Mellanox Care (MCare) Integration
- UFM on VM (UFM with remote fabric collector)
- Logical server auditing
- The UFM high availability script - /etc/init.d/ufmha - is no longer supported
- The UFM Multi-site portal feature is no longer supported. The Multi-Subnet feature can be used instead
- As of UFM Enterprise v6.18.0, UFM Agent discovery will be disabled by default, and managed switches will be discovered in-band
- As of UFM Enterprise v6.18.0, the `ibdiagpath` diagnostic utility is deprecated
- As of UFM Enterprise version 6.14.0, UFM Monitoring Mode is deprecated and is no longer supported
- As of UFM Enterprise v6.12.0, the Logical Elements tab is removed
- Removed the following fabric validation tests: CheckPortCounters & CheckEffectiveBER

In order to continue working with `/etc/init.d/ufmha` options, use the same options using the `/etc/init.d/ufmd` script.

For example:

Instead of using `/etc/init.d/ufmha model_restart`, please use `/etc/init.d/ufmd model_restart` (on the primary UFM server)

Instead of using `/etc/init.d/ufmha sharp_restart`, please use `/etc/init.d/ufmd sharp_restart` (on the primary UFM server)

The same goes for any other option that was supported on the `/etc/init.d/ufmha` script

1.3 Installation Notes

1.3.1 Supported Devices

1.3.1.1 Supported NVIDIA Externally Managed Switches

Type	Model	Latest Tested Firmware Version
NDR switches	<ul style="list-style-type: none">MQM9790	31.2021.4036
HDR switches	<ul style="list-style-type: none">MQM8790	27.2012.4036
EDR switches	<ul style="list-style-type: none">SB7790SB7890	15.2010.4402

1.3.1.2 Supported NVIDIA Internally Managed Switches

Type	Model	Latest Tested OS Version
NDR switches	<ul style="list-style-type: none">MQM9700	MLNX-OS 3.12.1002 NVOS 25.01.4000
HDR switches	<ul style="list-style-type: none">MQ8700MCS8500TQ8100-HS2FTQ8200-HS2F	MLNX-OS 3.12.1002
EDR switches	<ul style="list-style-type: none">SB7700SB7780SB7800CS7500CS7510CS7520	MLNX-OS 3.10.4400

1.3.2 System Requirements

1.3.2.1 Bare Metal Deployment Requirements

Platform	Type and Version
OS (Relevant for Standalone and High-Availability deployments)	64-bit OS: <ul style="list-style-type: none"> • RedHat 8 • RedHat 9 • Ubuntu 20.04 • Ubuntu 22.04
CPU ^(a)	x86_64
HCA ^s	<ul style="list-style-type: none"> • NVIDIA ConnectX®-4 with Firmware 12.28.2006 and above • NVIDIA ConnectX®-5 with Firmware 16.35.4030 and above • NVIDIA ConnectX®-6 with Firmware 20.24.4702 and above • NVIDIA ConnectX®-7 with Firmware 28.42.0428 and above • NVIDIA Mezzanine Board with Four ConnectX-7 ASICs for Multi-GPU Connectivity (CEDAR) with Firmware 28.36.0394 and above • NVIDIA BlueField with Firmware 24.33.900 and above • NVIDIA BlueField-2 with Firmware 24.33.900 and above • NVIDIA BlueField-3 with Firmware 32.42.0148 and above
OFED ^(b)	<ul style="list-style-type: none"> • MLNX_OFED 5.X • MLNX_OFED23.x • MLNX_OFED24.x

^(a) CPU requirements refer to resources consumed by UFM. You can also dedicate a subset of cores on a multicore server. For example, 4 cores for UFM on a 16-core server.

^(b) For supported HCAs in each MLNX_OFED version, please refer to MLNX_OFED Release Notes.

^(c) UFM v6.15.0 is the last version to support NVIDIA ConnectX-4 adapter cards

For running SHARP Aggregation Manager within UFM, it is recommended to use MLNX_OFED-5.4.X version or newer.

Installation of UFM on minimal OS distribution is not supported.

UFM does not support systems in which NetworkManager service is enabled. Before installing UFM on RedHat OS, make sure to disable the service.

1.3.2.2 Docker Installation Requirements

UFM Docker Container is supported on the standard docker environment (engine).

The following operating systems were tested with Docker Container (as standalone container):

Component	Type and Version
Supported OS	<ul style="list-style-type: none"> • RHEL8 • RHEL9 • Ubuntu18.04 • Ubuntu20.04 • Ubuntu22.04

For UFM Docker Container installation in HA mode, please refer to [Bare Metal Deployment Requirements](#) for the list of operating systems and kernels which support HA.

On some Ubuntu OSs, Docker is installed via SNAP, which might lead to errors when trying to use UFM Plugins.

To solve this issue, perform the following:

1. Remove Docker installed via SNAP, run:

```
snap remove --purge docker
```

2. Update the local package index, run :

```
apt update
```

3. Install native Docker, run:

```
apt install-y docker.io
```

1.3.2.3 UFM Server Resource Requirements per Cluster Size

Fabric Size	CPU Requirements*	Memory Requirements	Disk Space Requirements	
			Minimum	Recommended
Up to 1000 nodes	4-core server	4 GB	20 GB	50 GB
1000-5000 nodes	8-core server	16 GB	40 GB	120 GB
5000-10000 nodes	16-core server	32 GB	80 GB	160 GB
Above 10000 nodes	Contact NVIDIA Support			

1.3.2.4 UFM GUI Client Requirements

The platform and GUI requirements are detailed in the following tables:

Platform	Details
Browser	Edge, Internet Explorer, Firefox, Chrome, Opera, Safari

Platform	Details
Memory	<ul style="list-style-type: none"> • Minimum: 8 GB • Recommended: 16 GB

1.3.2.5 MFT Package Version

Platform	Details
MFT	Integrated with MFT version 4.29.0-131

1.3.2.6 UFM SM Version

Platform	Type and Version
SM	UFM package includes SM version 5.20.0

Assuming the SM is connected to the production cluster, it can handle any events (IB traps) coming from the fabric that is being built; such events should not affect the routing on the production cluster. If events occurred in the production cluster, the routing could be changed.

However, NVIDIA recommends isolating fabric sections to allow faster bring-ups, faster troubleshooting and misconfiguration avoidance that can cause routing errors. Isolation provides clearer SM and CollectX logs, avoiding warnings/errors from masking real production issues.

1.3.2.7 UFM NVIDIA SHARP Software Version

Platform	Type and Version
NVIDIA® Scalable Hierarchical Aggregation and Reduction Protocol (SHARP)™	UFM package includes NVIDIA SHARP software version 3.8.0

1.3.2.8 Used Ports by UFM Server

For a list of ports used by the UFM Server for internal and external communication, refer to [Appendix - Used Ports](#).

1.3.3 Software Update from Prior Versions

The installer detects versions previously installed on the machine and prompts you to run a clean install of the new version or to upgrade while keeping user data and configuration unchanged.

The upgrade from previous versions maintains the existing database and configuration, allowing a seamless upgrade process.

Upgrading UFM Enterprise software version is supported up to two previous GA software versions (GA -1 or -2).
 For example, if you wish to upgrade to UFM Enterprise v6.17.0, it is possible to do so only from UFM Enterprise v6.16.0 or v6.15.0.

Due to a possible conflict, SM and SHARP installed by the MLNX_OFED must be uninstalled. The installation procedure will detect and print all MLNX_OFED packages that must be removed.

1.4 Bug Fixes in This Release

Ref #	Description
4012915	Description: Fixed bug in SMTP configuration
	Keywords: SMTP, Configuration
	Discovered in Release: v6.17.1
3985023	Description: Fixed the issue where GUIDs could not be assigned to empty keys in the REST API
	Keywords: REST API, GUID, Empty Keys
	Discovered in Release: v6.17.2
3959780	Description: Fixed the issue with missing telemetry data on the dashboard after installing UFM Enterprise v6.17.1
	Keywords: Telemetry, Data, Dashboard
	Discovered in Release: v6.17.1
3912416	Description: Fixed the issue where the Web UI frequently exits after the admin password was changed
	Keywords: WebUI, Exit, Password
	Discovered in Release: v6.17.0
3881365	Description: Fixed the issue with the CloudX REST API malfunctioning when deleting a port associated with a PKey
	Keywords: CloudX, REST API, PKey, Port
	Discovered in Release: v6.15.2

1.5 Known Issues in This Release

Ref #	Description
3991199	Description: Dynamic Telemetry instances are not recovered during the backup/restore procedure
	Keywords: Dynamic Telemetry, Backup, Restore
	Workaround: N/A
	Discovered in Release: 6.17.5

For a list of known issues from previous releases, please refer to [Known Issues History](#).

1.6 Changes and New Features History

The items listed in the table below apply to all UFM license types.

Feature	Description
Rev 6.16.0	
Syslog Streaming	Added the option for setting UFM syslog streaming facility. For more information, refer to Configuring Syslog .
Switch Cables REST API	Added the option to query specific switch cables (using Ports API).
Switch Power Information	Added support for switch and modules power usage data in UFM telemetry and REST API. For more information, refer to Devices Window and Inventory Window .
UFM Data Streaming	Added the ability to change the UFM Data streaming log facility. For more information, refer to Configuring Syslog and Configuring UFM Logging .
Kerberos Authentication	Added the ability for Kerberos authentication, a strong network authentication protocol for client-server applications. For more information, refer to Kerberos Authentication and Enabling Kerberos Authentication .
SM Settings	Changed the default maximal number of VLs to 2 (VL0 - VL1). For more information, refer to Appendix - UFM Subnet Manager Default Properties .
Cable Management	Added support for showing transceiver information for downed links. For more information, refer to Cables Window and Network Map .
Secondary Telemetry	Added the <code>secondary_slvl_support</code> flag and information on the default counters. For more information, refer to Secondary Telemetry .
Congestion Control	Added support for SM congestion control settings. For more information, refer to Appendix - OpenSM Configuration Files for Congestion Control .
UFM HA	Enhanced reliability and added support for setting UFM HA on LVM (Logical Volume Manager). For more information, refer to UFM High-Availability Documentation .
Plugins	Packet Mirroring Collector (PMC) Plugin: Added support for event on PF indicating a QP closing with error on any other GVMI/VF. For more information, refer to Packet Level Monitoring Collector (PMC) Plugin .
	PDR Deterministic Plugin: Updated instructions. For more information, refer to PDR Deterministic Plugin .
	GNMI-Telemetry Plugin: Added gNMI telemetry streaming support (supporting secured mode streaming). For more information, refer to GNMI-Telemetry Plugin .
	NDT Plugin (Subnet Merger): Added the option to validate the extended fabric using cable validation tool. For more information, refer to the NDT Plugin .
Rev 6.15.2	
UFM SM	New routing algorithm for asymmetric QFT topologies

Rev 6.15.1	
SHARP Reservation	Added support for Auto-cleanup of zombie SHARP reservations
Rev 6.15.0	
Defining Node Description	To prevent the formation of incorrect multi-NIC groups based on these default labels, this feature offers the option to establish a blacklist containing possible node descriptions that should be avoided when grouping Multi-NIC HCAs during host startup. For more information, refer to Defining Node Description Black-List .
Network Reports	Added the ability to view topology change events related to devices and links. For more information, refer to Events History , Device Status Events and Link Status Events .
User Authentication	Introduced a new user authentication login page. For more information, refer to Azure Authentication Login Page and Enabling Azure AD Authentication .
	Added support for a separate authentication server. For more information, refer to UFM Authentication Server and Enabling UFM Authentication Server .
Secondary Telemetry	Added the ability to expose SHARP telemetry in UFM Telemetry. For more information, refer to Exposing Switch Aggregation Nodes Telemetry .
	Added the ability to stop SHARP telemetry endpoint using CLI commands. For more information, refer to Stopping Telemetry Endpoint Using CLI Command .
REST APIs	Enhanced the logging REST API by adding the ability to get event logs in JSON file format. For more information, refer to Get Events Logs in JSON Format .
	Added the ability to expose managed switch power consumption in Web UI. For more information, refer to Get Managed Switches Power Consumption .
	Added ability to filter the event logs by source. For more information, refer to Create Log History .
	Added the ability to generate enterprise network reports. For more information, refer to Events History , Device Status Events and Link Status Events .
	Introduced REST APIs for various authentication types. For more information, refer to Examples of REST APIs Using Various Authentication Types .
	Added the ability to update UFM Configuration REST API. For more information, refer to UFM Configuration REST API .
	Added the option to expose cable information. For more information, refer to Get Ports with Cable Information .
	Improved dynamic telemetry by adding the ability to instantiate a new instance and delete a running instance. For more information, refer to UFM Dynamic Telemetry Instances REST API .
	Added the option to set “down” ports as unhealthy. For more information, refer to Unhealthy Ports REST API .
	Added forge InfiniBand anti-spoofing support. For more information, refer to Forge InfiniBand Anti-Spoofing REST API .
Added the ability to expose the "site_name" field in all supported REST APIs. For more information, refer to REST API Complementary Information .	
Plugins	Added support for the gNMI-Telemetry plugin that employs the gNMI protocol to stream data from UFM telemetry. In addition, added support for secure mode based on client authentication. For more information, refer to the GNMI-Telemetry Plugin .
	Added support for ALM configuration for controlling isolation/de-isolation. For more information, refer to ALM Configurations .

	REST over RDMA Plugin: Moved to Ubuntu 22-based docker container, OFED 5.8-3.0.7.0, ucx_py 0.35.0 and Python 3.10.
Supported Transceivers	Added support for FR4 transceivers
Rev 6.14.2	
Cable and Transceivers Burning	UFM supports second-source cable transceivers burn.
Module REST API	Added HW revision field in GET module REST API response.
Telemetry	Added support for the MRCS register read in UFM Telemetry.
UFM Reports	UFM Daily report will be disabled by default after upgrade or clean installation.
Rev 6.14.0	
UFM Upgrade	Added support for in-service upgrade procedure for UFM HA. Refer to the following sections: <ul style="list-style-type: none"> • Upgrading UFM on Bare Metal - High Availability Upgrade • Upgrading UFM Container in High Availability Mode
User Authorization	Added support for user-defined roles based on REST APIs subsets. Refer to Rest Roles Access Control .
User Authentication	Added support for user authentication based on Azure Active Directory. Refer to Azure AD Authentication .
Plugins Management	Added support for loading UFM plugin to both master and standby nodes in case of UFM HA deployment. Refer to Plugin Management .
Unhealthy Ports Policy Management	Added support for unhealthy ports policy management via UFM Web UI. Refer to Health Policy Management .
REST over RDMA Plugin	Added support for remote ibdiagnet authentication. Refer to rest-rdma Plugin .
SHARP Reservation	Added support for synchronous SHARP reservation REST API (in addition to the existing asynchronous REST API). Refer to the NVIDIA SHARP REST API .
Secondary Telemetry	Added support for secondary telemetry running by default upon UFM startup, fetching NVIDIA Amber counters. Refer to Secondary Telemetry . Added support for down ports telemetry. Refer to Secondary Telemetry .
PCI Analysis	Added support for PCI analysis as part of UFM Fabric Analysis Report (added new events for degraded hosts PCI devices). Refer to Appendix - Supported Port Counters and Events .
UFM System Dump	Added human readable time to the dmsg de-message output as part of UFM system dump.
Factory Reset	Added support for UFM Factory Reset. Refer to UFM Factory Reset .
Rev 6.13.0	
Network Fast Recovery	Added the ability to automatically isolate a malfunctioning switch port as detected by the switch. Refer to Enabling Network Fast Recovery
Multi-Subnet UFM	Added support for multiple UFM instances, wherein multiple instances are aggregated, managed and controlled by a centralized UFM instance. Refer to Multi-Subnet UFM .
Switch ASIC Failure Detection	Added support for a new indication (UFM event) that identifies a failure of a specific switch ASIC. Refer to Configuring Partial Switch ASIC Failure Events .

UFM High-Availability Enhancements	Added support for configuring high-availability with dual-link connections to improve the high-availability robustness.
Automatic Switch Grouping	Added support for enabling automatic grouping of 1U switches by UFM, as per a pre-defined user-configured mapping. Refer to Appendix - Switch Grouping .
SHARP Trees APIs	Incorporated support for a new UFM REST API that presents the current active SHARP trees. Refer to NVIDIA SHARP Resource Allocation REST API .
SHARP Reservation APIs	Added support for SHARP Reservation API enhancements. Refer to NVIDIA SHARP Resource Allocation REST API .
Operating System Update support	Implemented functionality to support the installation and upgrade of a standalone UFM after the upgrade of operating system packages (e.g., using yum update/apt upgrade). Furthermore, upgrading operating system packages will not impact a standalone UFM installation.
Email Time-Zone Settings	Added the ability to configure time-zone settings for UFM email notifications, ensuring that sent events or daily reports align with the configured time zone. Refer to Email .
Switch Connectivity Failure Indication	Incorporated support for a new UFM event indication that identifies failed communication with a specified managed switch. Appendix - Supported Port Counters and Events
Dynamic Telemetry	Added APIs that enable the creation and management of UFM Telemetry instances, allowing users to select desired counters and ports as per their requirements. Refer to UFM Dynamic Telemetry Instances REST API.
TFS (Telemetry Fluent Streaming) Plugin	Added support for UFM telemetry data streaming from multiple endpoints to Fluent Bit. Refer to Telemetry to Fluent Streaming (TFS) Plugin REST API .
	Added support for enabling white/black counters lists within the TFS Plugin. Refer to Telemetry to Fluent Streaming (TFS) Plugin REST API .
DTS (DPU Telemetry) Plugin	Added support for displaying DPUs data within the UFM Web UI. Refer to DTS Plugin .
Cyber-AI Plugin	Added support for displaying Cyber-AI software within the UFM Web UI. Refer to UFM Cyber-AI Plugin .
Packet Mirroring Collector (PMC) Plugin	Added the Packet Mirroring Collector (PMC) plugin that allows users to catch and collect mirrored pFRN and congestion notifications from switches for enhanced real-time network visibility. Refer to Packet Level Monitoring Collector (PMC) Plugin .
SNMP Traps Listener Plugin	Added the capability to enable registration and monitoring of SNMP traps from managed switches, in addition to updating UFM with the relevant trap information. Refer to SNMP Plugin .
Bright Cluster Integration Plugin	Added support for integration of data from Bright Cluster Manager (BCM) into UFM, providing a more comprehensive network perspective. Refer to UFM Bright Cluster Integration Plugin .
UFM System Dump	UFM System Dump collection enhancement. Refer to UFM System Dump Tab.
Expanding Non-Blocking Fabric (NDT Plugin extension)	Added a feature that facilitates seamless expansion of the IB fabric, ensuring uninterrupted functionality and optimal performance throughout the fabric. Refer to NDT Format - Merger .

PDR (Packet Drop Rate) Plugin	Added a new functionality that enables automatic detection and isolation of port failures through monitoring of PDR (Packet Drop Rate), BER (Bit Error Rate), and high cable temperatures. Refer to PDR Deterministic Plugin .
Rev 6.12.0	
Managed Switches - Sysinfo Mechanism	Added the ability to save switches inventory data into JSON format files and present the latest fetched switches data upon UFM start-up. The saved switches data is available UFM upon system dump. Refer to Appendix - Managed Switches Configuration Info Persistency
REST over RDMA Plugin	Introduced security improvements (allowed read-only options in remote ibdiagnet) and added support for Telemetry API. Refer to REST-RDMA Plugin .
Events and Notifications	Added support for indicating potential switch ASIC failure by detecting a defined percentage of unhealthy switch ports. Refer to Additional Configuration (Optional)
SHARP AM Multi-Port	Added support for detecting IB fabric interface failure and automatic failover to an alternative active port in SHARP Aggregation Manager (AM). Refer to Multi-port SM
UFM System Dump	Added support for downloading the generated UFM system dump. Refer to UFM System Dump Tab
UFM REST API	Added support for adding or removing hosts to Partition key (PKey) assignments (when adding/removing hosts, all the related host GUIDs are assigned to/removed from the PKey). Refer to Add Host REST API
	UFM System Dump Improvements including Creating New System Dump API
UFM SLURM Integration	Enhanced UFM SLURM integration; allow flexible configuration of PKey and SHARP resources usage. Refer to Appendix - UFM SLURM Integration
UFM HA	Improved UFM HA configuration by setting UFM HA nodes using IP addresses only (removed the need of using hostnames and sync interface names). Refer to Configuring UFM Docker in HA Mode and Installing UFM Server Software for High Availability
Managed Switch Operations	Added support for persistent enablement/disablement of managed switches ports. Refer to Ports Window
UFM SDK	Created a script to get TopX data by category. Refer to UFM Aggregation TopX README.md file
Proxy Authentication	Added option to delegate authentication to a proxy. Refer to Delegate Authentication to a Proxy
UFM Initial Settings	Removed the requirement to set the IPoIB address to the main IB interface used by UFM/SM (gv.cfg → fabric_interface)
Port auto-isolation	Symbol BER warning does not trigger port auto-isolation, only symbol BER error
MFT Package	Integrated with MFT version 4.23.0-104
Rev 6.11.0	
UFM Discovery and Device Management	<ul style="list-style-type: none"> InBand autoscovery of switches' IP addresses using <code>ibdiagnet</code> Discovering the device's PSID and FW version using <code>ibdiagnet</code> by default instead of using an SM vendor plugin
CPU Affinity	Enabling the user to control CPU affinity of UFM's major processes
gRPC API	Added support for streaming UFM REST API data over gRPC as part of new UFM plugin. Refer to gRPC-Streamer Plugin

Telemetry	<ul style="list-style-type: none"> Added support for flexible counters infrastructure (ability to change counter sets that are sampled by the UFM) Updated the set of available counters for Telemetry (removed General counters from default view: Row BER, Effective BER and Device Temperature. Now available through the secondary telemetry instance). Refer to Secondary Telemetry
EFS UFM Plugin	Added support for streaming UFM events data to FluentD destination as part of a new UFM plugin. Refer to UFM Telemetry Fluentd Streaming (TFS) Plugin
General UI Enhancements	<ul style="list-style-type: none"> Displayed columns of all tables are persistent per user, with the option to restore defaults. Refer to Displayed Columns Improved look and feel in Network Map. Refer to Network Map Added Reveal Uptime to the general tab in the devices information tabs. Refer to Device General Tab
High Availability Deployment	<ul style="list-style-type: none"> Added support for joining a new UFM device into the HA pair without stopping the UFM HA (in case of a secondary UFM node permanent failure). For more information, refer to Installing UFM Server Software for High Availability Changed UFM HA package installation command parameters. For more information, refer to Installing UFM Server Software for High Availability
REST APIs	<p>Added support for PKey filtering for default session data. Refer to Get Default Monitoring Session Data by PKey Filtering.</p> <p>Added support for filtering session data by groups. Refer to Monitoring Sessions REST API.</p> <p>Added support for resting all unhealthy ports at once. Refer to Mark All Unhealthy Ports as Healthy at Once</p> <p>Added support for presenting system uptime in UFM REST API. Refer to Systems REST API.</p>
Deployment Installation	UFM installation is now based on Conda-4.12 (or newer) for python3.9 environment and third party packages deployments.
NVIDIA SHARP Software	Updated NVIDIA SHARP software version to v3.1.1.
UFM Logical Elements	UFM Logical Elements (Environments, Logical Servers, Networks) views are deprecated and will no longer be available starting from UFM v6.12.0 (January 2023 release)
Rev 6.10.0	
System health enhancements	Add support for the periodic fabric health report, and reflected the ports' results in UFM's dashboard
UFM Plugins Management	Add support for plugin management via UFM web UI
UFM Extended Status	<ul style="list-style-type: none"> Add support for showing UFM's current processes status (via shell script) Added REST API for exposing UFM readiness
Failover to Other Ports	Add support for SM and UFM Telemetry failover to other ports on the local machine
UFM Appliance Upgrade	Added a set of REST APIs for supporting the UFM Appliance upgrade
Configuration Audit	Add support for tracking changes made in major UFM configuration files (UFM, SM, SHARP, Telemetry)
UFM Plugins	Add support for new SDK plugins
Telemetry	Add support for statistics processing based on UFM telemetry csv format
UFM High Availability Installation	UFM high availability installation has changed and it is now based on an independent high availability package which should be deployed in addition to the UFM Enterprise standalone package. for further details about the new UFM high availability installation, please refer to - Installing UFM Server Software for High Availability

1.7 Bug Fixes History

Ref. #	Description
Rev 6.17.0	
39124 16	Description: Fixed issue with the authentication server being repeatedly restarted by the UFM health check after the default admin password is changed
	Keywords: Authentication, Server, Disable
	Discovered in Release: v6.17.0
38639 58	Description: Fixed issue where IB-IB go to INIT states due to failed UFM failover after enabling SHARP with PKeys
	Keywords: SHARP, PKey, IB-IB Link, Failover
	Discovered in Release: v6.16.0
38506 73	Description: Fixed issue where multiple ports go down simultaneously (link-downed counter increment)
	Keywords: Ports, down, simultaneous
	Discovered in Release: v6.15.1
38502 17	Description: Fixed issues with ALM plugin (disabled handling topology changes and limited the number of trials of creating dynamic telemetry sessions by configurable variables)
	Keywords: ALM Plugin
	Discovered in Release: v6.15.0
38265 44	Description: Fixed node info discovery issue
	Keywords: Node, Info, Discovery
	Discovered in Release: v6.16.0
38260 69	Description: Fixed HCA port naming convention inconsistencies in UFM WebUI
	Keywords: HCA port, Port name, WebUI
	Discovered in Release: v6.15.2
38161 96	Description: Fixed issue where UFM creates empty PKeys by UFM Rest API
	Keywords: Empty, PKey, REST API
	Discovered in Release: v6.15.2
38114 75	Description: Fixed issue where UFM loggings REST API omits additional contents of the log when it spans over multiple lines
	Keywords: UFM Loggings, REST API, Span over, Multiple Lines
	Discovered in Release: v6.15.3
38035 27	Description: Fixed issue with Create History REST API while collecting SM Logs Error
	Keywords: Create History, SM Log Error
	Discovered in Release: v6.15.3
37521 96	Description: Fixed intermittent UFM REST API Failures
	Keywords: UFM REST API, Failures

	Discovered in Release: v6.16.0
3864876	Description: Fixed issue with UFM events not appearing in remote syslog
	Keywords: UFM Events, Remote syslog
	Discovered in Release: v6.15.1
3809574:	Description: Fixed WebUI issues in the "Power" column
	Keywords: WebUI, Power
	Discovered in Release: v6.16.0
3766079	Description: Fixed issue with UFM not showing SSH user/pass tab
	Keywords: SSH, User/Pass Tab
	Discovered in Release: v6.15.0
3916656	Description: Fixed issue with releasing lock without acquiring when handling MC join requests from unknown source.
	Keywords: MC, lock
	Discovered in Release: v6.17.0
Rev 6.16.0	
3754940	Description: Fixed issue where following the UFM HA upgrade from version 5.0.1-2 to version 5.3.1-2, the <code>ufm_ha_cluster config</code> command wiped the root partition
	Keywords: UFM HA Upgrade, <code>ufm_ha_cluster config</code> , Root Partition, Wipe
	Discovered in Release: 6.15.2
3752196	Description: Fixed intermittent UFM REST API Failures
	Keywords: REST API, Failure
	Discovered in Release: 6.15.1
3758874	Description: Fixed <code>manage_the_unmanaged</code> tool failure
	Keywords: <code>manage_the_unmanaged</code> , Failure
	Discovered in Release: 6.15.2
3773902	Description: Fixed the issue in congestion control, where <code>cc-policy.conf</code> file remains unchanged following the upgrade of the container version (with no changes made by the user)
	Keywords: Congestion Control, <code>cc-policy.conf</code> , Upgrade, Container
	Discovered in Release: 6.16.0-4
Rev 6.15.1	
3670183	Description: Monitoring endpoint not returning counters for an active interface
	Keywords: Monitoring, Active Interface, Counters
	Discovered in release: v6.15.0
3670182	Description: Inconsistent port format type returned from the UFM
	Keywords: Inconsistent, Port, Format Type
	Discovered in release: v6.14.1
3666944	Description: Port auto isolation failed to activate when a port consistently exhibited a high Symbol BER (1e-7)

	Keywords: Port Auto Isolation, Symbol BER
	Discovered in release: v6.13.1
36653 16	Description: The UFM REST API endpoint <code>/ufmRest/resources/ports</code> provide inaccurate port state information
	Keywords: Ports REST API, Port State
	Discovered in release: v6.14.1
36041 94	Description: UFM Fabric Validation " <code>CheckPortCounters</code> " failure
	Keywords: Fabric Validation, <code>CheckPortCounters</code>
	Discovered in release: v6.13.2
Rev 6.15.0	
36650 01	Description: UFM Web UI does not display Network Map (stuck with "please wait" message)
	Keywords: Web UI, Network Map
	Discovered in release: v6.14.1
36445 53	Description: When querying the ports, adding a <code>cable_info=true</code> as an argument will give cable information per port
	Keywords: Ports, Query, <code>cable_info=true</code>
	Discovered in release: v6.14.0
36042 12	Description: Broken links REST API
	Keywords: REST API, Broken link
	Discovered in release: v6.13.2
36041 83	Description: UFM error UFM NOT performed OpenSM polling for fabric changes more than 230742 seconds
	Keywords: OpenSM, UFM Error
	Discovered in release: v6.13.2-5
36040 21	Description: UFM Enterprise installation under Ubuntu 22.04 fails on <code>configure_ha_nodes.sh</code>
	Keywords: Ubuntu 22.04, Installation, <code>configure_ha_nodes.sh</code>
	Discovered in release: v6.14.1-5
35878 49	Description: OpenSM restarted when backup UFM lost power
	Keywords: OpenSM, Restart
	Discovered in release: v6.9
35774 27	Description: UFM REST API returns wrong switch type for NDR unmanaged switch
	Keywords: Unmanaged Switch, NDR, REST API
	Discovered in release: v6.13.1
35758 82	Description: UFM event is not generated for a switch down
	Keywords: UFM Event, Switch Down
	Discovered in release: v6.13.1
36284 21	Description: UFM Web UI timezone issue when selecting Local Time

	Keywords: Timezone, Web UI, Local Time
	Discovered in release: v6.14.1-5
35661 93	Description: Request for docker UFM HA support on Debian OS 10.13
	Keywords: Docker, HA support, Debian
	Discovered in release: v6.14.1-5
35658 20	Description: UFM container CLI bugs
	Keywords: CLI, Container
	Discovered in release: v6.13.2-5
Rev 6.14.0	
35907 77	Description: After upgrading UFM new telemetry data is not being collected and presented in UI Telemetry tab.
	Keywords: Telemetry, Coredump
	Discovered in release: 6.14.0
Rev 6.13.2	
32288 93	Description: ufm-prolog.sh failure: hostnames are not found in the fabric after reboot
	Keywords: Hostnames; <code>ufm-prolog.sh</code> , reboot
	Discovered in Release: 6.10.0
34956 92	Description: UFM Enterprise v6.13.1 server hangs intermittently, blocking UFM REST server, and UFM GUI
	Keywords: UFM REST, UFM GUI
	Discovered in Release: 6.13.1
N/A	Description: Reverted setGuidsForPkey APIs for supporting SHARP reservation (in case it is enabled)
	Keywords: setGuidsForPkey, SHARP Reservation
	Discovered in Release: 6.13.1
Rev 6.13.1	
34594 31	Description: UFM System Dump cannot be extracted from UFM 3.0 Enterprise Appliance host when running in high-availability mode.
	Keywords: System Dump, High-Availability
	Discovered in Release: 6.12.0
34616 58	Description: The network fast recovery configuration (<code>/opt/ufm/files/conf/opensm/fast_recovery.conf</code>) is missing when UFM is deployed in Docker Container mode.
	Keywords: Network Fast Recovery; Docker Container; Missing Configuration
	Discovered in Release: 6.12.0
34610 58	Description: When using the Dynamic Telemetry API to create a new telemetry instance, the log rotation mechanism will not be applied for the newly generated logs of the UFM Telemetry instance
	Keywords: Dynamic, Telemetry, Log-rotate
	Discovered in Release: 6.13.0

1.8 Known Issues History

Ref #	Issue
Rev 6.17.0	
3859362	Description: UFM TFS endpoint dashboard report Switch port TX/RX rate reach Tbps
	Keywords: TFS, Switch Port, TX/RX
	Workaround: N/A
	Discovered in Release: v6.15.1
3881365	Description: Malfunctioning of the rest API when deleting port associated to a pkey
	Keywords: CloudX, API, Bare-Metal
	Discovered in Release: v6.15.2
3862847	Description: UFM reports wrong cable length for NDR optical cables connected to Quantum-2 NDR switch
	Keywords: NDR, Optical Cables, Quantum-2, Switch
	Workaround: N/A
	Discovered in Release: v6.17.0
Rev 6.16.0	
3791820	Description: Configuring the collection of SLVL on the secondary telemetry will result in SLVL data being sampled at a reduced rate.
	Keywords: SLVL, Multi-Rate, Reduced Rate
	Workaround: Edit the <code>launch_ibdiagnet_config.ini</code> file and restart the UFM telemetry. 1. Edit the <code>launch_ibdiagnet_config.ini</code> file by running the following command:
	<pre>vi /opt/ufm/files/conf/secondary_telemetry_defaults/launch_ibdiagnet_config.ini</pre>
	Comment the following line:
	<pre>#base_freq=1</pre>
2. Restart UFM telemetry:	
<pre>/etc/init.d/ufmd ufm_telemetry_stop /etc/init.d/ufmd ufm_telemetry_start</pre>	
Discovered in Release: 6.15.0	
3775405	Description: Upon UFM startup, an empty temporary folder will be created at /tmp folder every 10 minutes (due to periodic telemetry status check)
	Keywords: Empty folder, temporary, /tmp
	Workaround: Add <code>'rm -f /tmp/tmp*'</code> to crontab to run daily or change <code>instances_sessions_compatibility_interval</code> parameter in <code>gv.cfg</code> to 30/60 minutes
	Discovered in Release: v6.15.0

3560659	Description: Modifying the <code>mtu_limit</code> parameter for [MngNetwork] in <code>gv.cfg</code> does not accurately reflect changes upon restarting UFM.
	Keywords: <code>mtu_limit</code> , MngNetwork, <code>gv.cfg</code> , UFM restart
	Workaround: UFM needs to be restarted twice in order for the changes to take effect.
	Discovered in Release: v6.15.0
3729822	Description: The Logs API temporarily returns an empty response when SM log file contains messages from both previous year (2023) and current year (2024).
	Keywords: Logs API, Empty response, Logs file
	Workaround: N/A (issue will be automatically resolved after the problematic SM log file, which include messages from 2023 and 2024 years, will be rotated)
	Discovered in Release: v6.15.0
3675071	Description: UFM stops gracefully after the b2b primary cable is physically disconnected
	Keywords: UFM HA, B2B, Primary Cable Disconnection
	Workaround: N/A
	Discovered in Release: 6.14.1
N/A	Description: Execution of UFM Fabric Health Report (via UFM Web UI / REST API) will trigger <code>ibdiagnet</code> to use SLRG register which might cause some of the switch and HCA's firmware to stuck and cause the HCA's ports to stay at "Init" state.
	Keywords: Fabric Health Report, SLRG register, "Init" state, Switch, HCA
	Discovered in Release: 6.14.0
3538640	Description: Fixed ALM plugin log rotate function.
	Keywords: ALM, Plugin, Log rotate
	Discovered in Release: 6.13.0
3532191	Description: Fixed UFM hanging (database is locked) after corrective restart of UFM health.
	Keywords: Hanging, Database, Locked
	Discovered in Release: 6.13.0
3555583	Description: Resolved REST API links' inability to return hostname for computer nodes.
	Keywords: REST API, Links, Hostname, Computer Nodes
	Discovered in Release: 6.12.1
3549795	Description: Fixed <code>ufm_ha_cluster</code> status to show DRBD sync status.
	Keywords: <code>ufm_ha_cluster</code> , DRBD, Sync Status
	Discovered in Release: 6.13.0
3549793	Description: Fixed UFM HA installation failure.
	Keywords: HA, Installation
	Discovered in Release: 6.13.0
3547517	Description: Fixed UFM logs REST API returning empty result when SM logs exist on the disk.
	Keywords: Logs, SM logs, Empty
	Discovered in Release: 6.11.0
3546178	Description: Fixed SHARP jobs failure when SHARP reservation feature is enabled.

	Keywords: SHARP, Jobs, Reservation
	Discovered in Release: 6.13.0
3541477	Description: Fixed UFM module temperature alerting on wrong thresholds.
	Keywords: Module Temperature, Alert Threshold
	Discovered in Release: 6.13.0
3191419	Description: Fixed UFM default session API returning port counter values as NULL.
	Keywords: Null, Port Counter, Value, API
	Discovered in Release: 6.9.0
3560659	Description: Fixed proper update in [MngNetwork] mtu_limit in gv.cfg when restarting UFM.
	Keywords: mtu_limit, gv.cfg, Update, UFM restart
	Discovered in Release: 6.13.1
3534374	Description: Fixed configure_ha_nodes.sh failure when deploying UFM6.13.x HA on Ubuntu22.04.
	Keywords: configure_ha_nodes.sh, HA, Ubuntu22.04
	Discovered in Release: 6.13.0
3496853	Description: Fixed daily report not being sent properly.
	Keywords: Daily Report, Failure
	Discovered in Release: 6.13.0
3469639	Description: Fixed REST RDMA server failure every couple of days, causing inability to retrieve ibdiagnet data.
	Keywords: REST RDMA, ibdiagnet
	Discovered in Release: 6.12.0
3455767	Description: Fixed incorrect combination of multiple devices in monitoring.
	Keywords: Monitoring, Incorrect combination
	Discovered in Release: 6.12.0
3511410	Description: Collect system dump for DGX host does not work due to missing sshpass utility.
	Workaround: Install sshpass utility on the DGX .
	Keywords: System Dump, DGX, sshpass utility
3432385	Description: UFM does not support HDR switch configured with hybrid split mode, where some of the ports are split and some are not.
	Workaround: UFM can properly operate when all or none of the HDR switch ports are configured as split.
	Keywords: HDR Switch, Ports, Hybrid Split Mode
3472330	Description: On bare-metal high availability (HA), when initiating a UFM system dump from either the master or standby node, the collection process will not include the HA dumps (pacemaker and DRBD).
	Workaround: To extract the HA system dump from bare-metal, run the following command from the master/standby nodes:
	<pre>/usr/bin/vsysinfo -S all -e -f /etc/ufm/ufm-ha-sysdump.conf -O /tmp/HA_sysdump</pre>
	The extracted HA system dump are stored in <code>/tmp/HA_sysdump.gz.tar</code>

	Keywords: UFM System Dump, HA, Bare-Metal
3461658	<p>Description: After the upgrade from UFM Enterprise v6.13.0 GA to UFM Enterprise v6.13.1 FUR, the network fast recovery path in <code>opensm.conf</code> is not automatically updated and remains with a null value (<code>fast_recovery_conf_file (null)</code>)</p> <p>Workaround: If you wish to enable the network fast recovery feature in UFM, make sure to set the appropriate path for the current fast recovery configuration file (<code>/opt/ufm/files/conf/opensm/fast_recovery.conf</code>) in the <code>opensm.conf</code> file located at <code>/opt/ufm/files/conf/opensm</code>, before starting UFM.</p> <p>Keywords: Network fast recovery, Missing, Configuration</p>
N/A	<p>Description: Enabling a port for a managed switch fails in case that port is not disabled in a persistent way (this may occur in ports that were disabled on previous versions of UFM - prior to UFM v6.12.0)</p> <p>Workaround: Set "persistent_port_operation=false" in <code>gv.cfg</code> to use non-persistent (legacy) disabling or enabling of the port. UFM restart is required.</p> <p>Keywords: Disable, Enable, Port, Persistent</p>
3346321	<p>Description: Failover to another port (multi-port SM) will not work as expected in case UFM was deployed as a docker container</p> <p>Workaround: Failover to another port (multi-port SM) works properly on UFM Bare-metal deployments</p> <p>Keywords: Failover to another port, Multi-port SM</p>
3348587	<p>Description: Replacement of defected nodes in the HA cluster does not work when PCS version is 0.9.x</p> <p>Workaround: N/A</p> <p>Keywords: Defected Node, HA Cluster, pcs version</p>
3336769	<p>Description: UFM-HA: In case the back-to-back interface is disabled or disconnected, the HA cluster will enter a split-brain state, and the "ufm_ha_cluster status" command will stop functioning properly.</p> <p>Workaround: To resolve the issue:</p> <ol style="list-style-type: none"> 1. Connect or enable the back-to-back interface 2. Run <pre>pcs cluster start --all</pre> 3. Follow instructions in Split-Brain Recovery in HA Installation. <p>Keywords: HA, Back-to-back Interface</p>
3361160	<p>Description: Upgrading UFM Enterprise from versions 6.8.0, 6.9.0 and 6.10.0 results in cleanup of UFM historical telemetry database (due to schema change). This means that the new telemetry data will be stored based on the new schema.</p> <p>Workaround: To preserve the historical telemetry database data while upgrading from UFM version 6.8.0, 6.9.0 and 6.10.0, perform the upgrade in two phases. First, upgrade to UFM v6.11.0, and then upgrade to the latest UFM version (UFM v6.12.0 or newer). It is important to note that the upgrade process may take longer depending on the size of the historical telemetry database.</p> <p>Keywords: UFM Historical Telemetry Database, Cleanup, Upgrade</p>
3346321	<p>Description: In some cases, when multiport SM is configured in UFM, a failover to the secondary node might be triggered instead of failover to the local available port</p> <p>Workaround: N/A</p>

	Keywords: Multiport SM, Failover, Secondary port
3240664	Description: This software release does not support upgrading the UFM Enterprise version from the latest GA version (v6.11.0). UFM upgrade is supported in UFM Enterprise v6.9.0 and v6.10.0.
	Workaround: N/A
	Keywords: UFM Upgrade
3242332	Description: Upgrading MLNX_OFED uninstalls UFM
	Workaround: Upgrade UFM to a newer version (v6.11.0 or newer), then upgrade MLNX_OFED
	Keywords: MLNX_OFED, Uninstall, UFM
3237353	Description: Upgrading from UFM v6.10 removes MLNX_OFED crucial packages
	Workaround: Reinstall MLNX_OFED/UFM
	Keywords: MLNX_OFED, Upgrade, Packages
N/A	Description: Running UFM software with external UFM-SM is no longer supported
	Workaround: N/A
	Keywords: External UFM-SM
3144732	Description: By default, a managed Ubuntu 22 host will not be able to send system dump (sysdump) to a remote host as it does not include the sshpass utility.
	Workaround: In order to allow the UFM to generate system dump from a managed Ubuntu 22 host, install the sshpass utility prior to system dump generation.
	Keywords: Ubuntu 22, sysdump, sshpass
3129490	Description: HA uninstall procedure might get stuck on Ubuntu 20.04 due to multipath daemon running on the host.
	Workaround: Stop the multipath daemon before running the HA uninstall script on Ubuntu 20.04.
	Keywords: HA uninstall, multipath daemon, Ubuntu 20.04
3147196	Description: Running the upgrade procedure on bare metal Ubuntu 18.04 in HA mode might fail.
	Workaround: For instructions on how to apply the upgrade for bare metal Ubuntu 18.04, refer to High Availability Upgrade for Ubuntu 18.04 .
	Keywords: Upgrade, Ubuntu 18.04, Docker Container, failure
3145058	Description: Running upgrade procedure on UFM Docker Container in HA mode might fail.
	Workaround: For instructions on how to apply the upgrade for UFM Docker Container in HA, refer to Upgrade Container Procedure.
	Keywords: Upgrade, Docker Container, failure
3061449	Description: Upon upgrade of UFM all telemetry configurations will be overridden with the new telemetry configuration of the new UFM version.
	Workaround: If the telemetry configuration is set manually, the user should set up the configuration after upgrading the UFM for the changes to take effect. Telemetry manual configuration should be set on the following telemetry configuration file right after UFM upgrade: <code>/opt/ufm/conf/telemetry_defaults/launch_ibdiagnet_config.ini</code> .
	Keywords: Telemetry, configuration, upgrade, override.
3053455	Description: UFM “Set Node Description” action for unmanaged switches is not supported for Ubuntu18 deployments
	Workaround: N/A
	Keywords: Set Node Description, Ubuntu18

3053455	Description: UFM Installations are not supported on RHEL8.X or CentOS8.X
	Workaround: N/A
	Keywords: Install, RHEL8, CentOS8
3052660	Description: UFM monitoring mode is not working
	Workaround: In order to make UFM work in monitoring mode, please edit telemetry configuration file: <code>/opt/ufm/conf/telemetry_defaults/launch_ibdiagnet_config.ini</code> Search for <code>arg_12</code> and set empty value: <code>arg_12=</code> Restarting the UFM will run the UFM in monitoring mode. Before starting the UFM make sure to set: <code>monitoring_mode = yes</code> in <code>gv.cfg</code>
	Keywords: Monitoring, mode
3054340	Description: Setting non-existing log directory will fail UFM to start
	Workaround: Make sure to set a valid (existing) log directory when setting this parameter (<code>gv.cfg</code> <code>log_dir</code>)
	Keywords: Log, Dir, fail, start

2 UFM Overview

2.1 Scale-Out Your Fabric with Unified Fabric Manager

NVIDIA®UFM is a host-based solution that provides all the management functionalities required for managing fabrics.

Fabric Topology with UFM

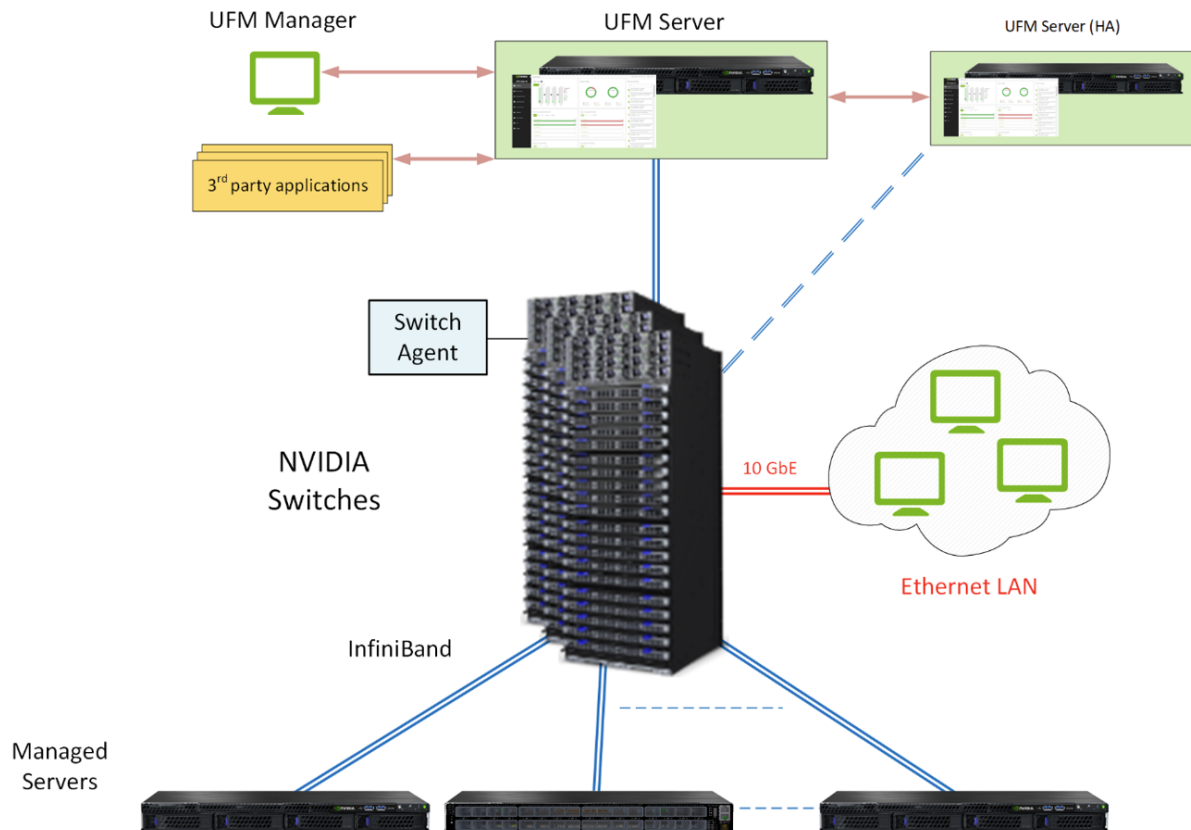

UFM Server is a server on which UFM is installed and has complete visibility over the fabric to manage routing on all devices.

UFM HA Server is a UFM installed server on a secondary server for High Availability deployment.

Managed Switching Devices are fabric switches, gateways, and routers managed by UFM.

Managed Servers are the compute nodes in the fabric on which the various applications are running, and UFM manages all servers connected to the fabric.

UFM Host Agent is an optional component that can be installed on the Managed Servers. UFM Host Agent provides local host data and host device management functionality.

The UFM Host Agent provides the following functionality:

- Discovery of IP address, CPU, and memory parameters on host
- Collection of CPU/Memory/Disk performance statistics on host
- Upgrading HCA Firmware and OFED remotely
- Creating an IP interface on top of the InfiniBand partition

UFM Switch Agent is an embedded component in NVIDIA switches that allows IP address discovery on the switch and allows UFM to communicate with the switch. For more information, please refer to [Device Management Feature Support](#).

2.2 UFM Benefits

Benefit	Description
Central Console for Fabric Management	UFM provides all fabric management functions in one central console. The ability to monitor, troubleshoot, configure and optimize all fabric aspects is available via one interface. UFM's central dashboard provides a one-view fabric-wide status view.
In-Depth Fabric Visibility and Control	UFM includes an advanced granular monitoring engine that provides real-time access to switch and host data, enabling cluster-wide monitoring of fabric health and performance, real-time identification of fabric-related errors and failures, quick problem resolution via granular threshold-based alerts and a fabric utilization dashboard.
Advanced Traffic Analysis	Fabric congestion is difficult to detect when using traditional management tools, resulting in unnoticed congestion and fabric under-utilization. UFM's unique traffic map quickly identifies traffic trends, traffic bottlenecks, and congestion events spreading over the fabric, which enables the administrator to identify and resolve problems promptly and accurately.
Enables Multiple Isolated Application Environments on a Shared Fabric	Consolidating multiple clusters into a single environment with multi-tenant data centers and heterogeneous application landscapes requires specific policies for the different parts of the fabric. UFM enables segmentation of the fabric into isolated partitions, increasing traffic security and application performance.
Service-Oriented Automatic Resource Provisioning	UFM uses a logical fabric model to manage the fabric as a set of business-related entities, such as time critical applications or services. The logical fabric model enables fabric monitoring and performance optimization on the application level rather than just at the individual port or device level. Managing the fabric using the logical fabric model provides improved visibility into fabric performance and potential bottlenecks, improved performance due to application-centric optimizations, quicker troubleshooting and higher fabric utilization.
Quick Resolution of Fabric Problems	UFM provides comprehensive information from switches and hosts, showing errors and traffic issues such as congestion. The information is presented in a concise manner over a unified dashboard and configurable monitoring sessions. The monitored data can be correlated per job and customer, and threshold-based alarms can be set.
Seamless Failover Handling	Failovers are handled seamlessly and are transparent to both the user and the applications running on the fabric, significantly lowering downtime. The seamless failover makes UFM in conjunction with other Mellanox products, a robust, production-ready solution for the most demanding data center environments.

Benefit	Description
Open Architecture	UFM provides an advanced Web Service interface and CLI that integrate with external management tools. The combination enables data center administrators to consolidate management dashboards while flawlessly sharing information among the various management applications, synchronizing overall resource scheduling, and simplifying provisioning and administration.

2.3 Main Functionality Modules

Module	Description
Fabric Dashboard	UFM's central dashboard provides a one-view fabric-wide status view. The dashboard shows fabric utilization status, performance metrics, fabric-wide events, and fabric health alerts. The dashboard enables you to efficiently monitor the fabric from a single screen and serves as a starting point for event or metric exploration.
Fabric Segmentation (PKey Management)	In the PKey Management view you can define and configure the segmentation of the fabric by associating ports to specific defined PKeys. You can add, remove, or update the association of ports to the related PKeys and update the qos_parameters for PKey (mtu, rate, service_level).
Fabric Discovery and Physical View	UFM discovers the devices on the fabric and populates the views with the discovered entities. In the physical view of the fabric, you can view the physical fabric topology, model the data center floor, and manage all the physical-oriented events.
Central Device Management	UFM provides the ability to centrally access switches and hosts, and perform maintenance tasks such as firmware and software upgrade, shutdown and restart.
Monitoring	UFM includes an advanced granular monitoring engine that provides real-time access to switch and server data. Fabric and device health, traffic information and fabric utilization are collected, aggregated and turned into meaningful information.
Configuration	In-depth fabric configuration can be performed from the Settings view, such as routing algorithm selection and access credentials. The Event Policy Table, one of the major components of the Configuration view, enables you to define threshold-based alerts on a variety of counters and fabric events. The fabric administrator or recipient of the alerts can quickly identify potential errors and failures, and actively act to solve them.
Fabric Health	The fabric health tab contains valuable functions for fabric bring-up and on-going fabric operations. It includes one-click fabric health status reporting, UFM Server reporting, database and logs' snapshots and more.
Logging	The Logging view enables you to view detailed logs and alarms that are filtered and sorted by category, providing visibility into traffic and device events as well as into UFM server activity history.

Module	Description
High Availability	In the event of a failover, when the primary (active) UFM server goes down or is disconnected from the fabric, UFM's High Availability (HA) capability allows for a secondary (standby) UFM server to immediately and seamlessly take over fabric management tasks. Failovers are handled seamlessly and are transparent to both the user and the applications running in the fabric. UFM's High Availability capability, when combined with NVIDIA's High Availability switching solutions allows for non-disruptive operation of complex and demanding data center environments.

Please refer to the following sections for UFM's main functionalities:

- [Events and Alarms](#)
- [Reports](#)
- [Telemetry2](#)

2.4 UFM Communication Requirements

This chapter describes how the UFM server communicates with InfiniBand fabric components.

2.4.1 UFM Server Communication with Clients

The UFM Server communicates with clients over IP. The UFM Server can belong to a separate IP network, which can also be behind the firewall.

UFM Server Communication with Clients

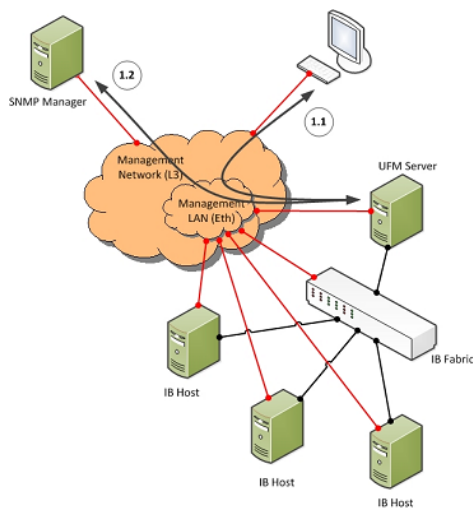

2.4.1.1 UFM Server Communication with UFM Web UI Client

Communication between the UFM Server and the UFM web UI client is HTTP(s) based. The only requirement is that TCP port 80 (443) must not be blocked.

2.4.1.2 UFM Server Communication with SNMP Trap Managers

The UFM Server can send SNMP traps to configured SNMP Trap Manager(s). By default, the traps are sent to the standard UDP port 162. However, the user can configure the destination port. If the specified port is blocked, UFM Server traps will not reach their destination.

2.4.1.3 Summary of UFM Server Communication with Clients

Affected Service	Network	Address / Service / Port	Direction
Web UI Client	Out-of-band management*	HTTP / 80 HTTPS / 443	Bi-directional
SNMP Trap Notification	Out-of-band management*	UDP / 162 (configurable)	UFM Server to SNMP Manager

*If the client machine is connected to the IB fabric, IPoIB can also be used.

2.4.2 UFM Server Communication with InfiniBand Switches

UFM Server Communication with InfiniBand Switches

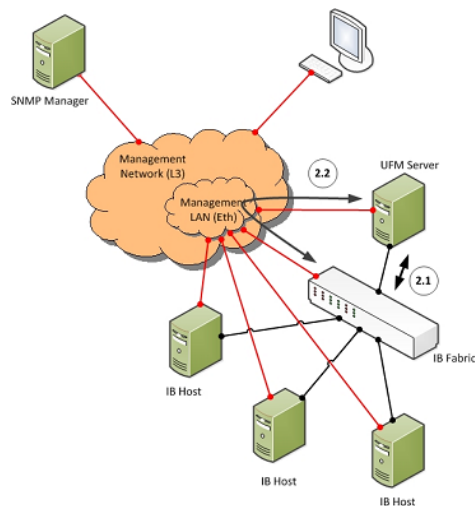

2.4.2.1 UFM Server InfiniBand Communication with Switch

The UFM Server must be connected directly to the InfiniBand fabric (via an InfiniBand switch). The UFM Server sends the standard InfiniBand Management Datagrams (MAD) to the switch and receives InfiniBand traps in response.

2.4.2.2 UFM Server Communication with Switch Management Software (Optional)

The UFM Server auto-negotiates with the switch management software on Mellanox Grid Director switches. The communication is bound to the switch Ethernet management port.

The UFM Server sends a multicast notification to MCast address 224.0.23.172, port 6306 (configurable). The switch management replies to UFM (via port 6306) with a unicast message that contains the switch GUID and IP address. After auto-negotiation, the UFM server uses Switch JSON API (HTTPS based) to retrieve inventory data and to apply switch actions (software upgrade and reboot) on the managed switch.

The following Device Management tasks are dependent on successful communication as described above:

- Switch IP discovery
- FRU Discovery (PSU, FAN, status, temperature)
- Software and firmware upgrades

The UFM Server manages IB Switch Devices over HTTPS (default port 443 - configurable) and / or SSH (default port 22 - configurable).

2.4.2.3 UFM Server Communication with Externally Managed Switches (Optional)

UFM server uses lbdagnet tool to discover chassis information (PSU, FAN, status, temperature) of the externally managed switches.

By monitoring chassis information data, UFM can trigger selected events when module failure occurs or a specific sensor value is above threshold.

2.4.2.4 Summary of UFM Server Communication with InfiniBand Switches

Affected Service	Network	Address / Service / Port	Direction
InfiniBand Management / Monitoring	InfiniBand	Management Datagrams	Bi-directional
Switch IP Address Discovery (auto-negotiation with switch management software)	Out-of-band management	Multicast 224.0.23.172, TCP / 6306 (configurable)	Multicast: UFM Server to switch TCP: Bi-directional
Switch Chassis Management / Monitoring	Out-of-band management	TCP / UDP / 6306 (configurable) SNMP / 161 (configurable) SSH / 22 (configurable)	Bi-directional

2.4.3 UFM Server Communication with InfiniBand Hosts

UFM Server Communication with InfiniBand Hosts

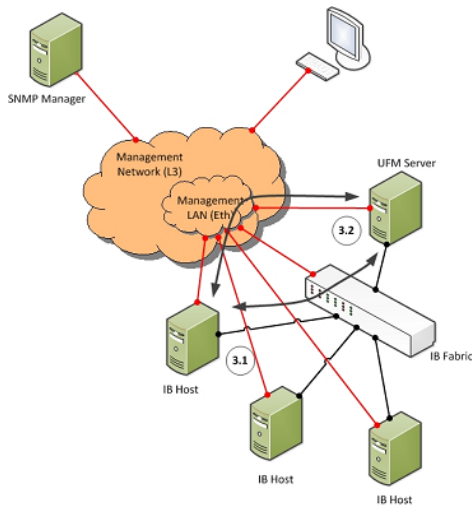

2.4.3.1 UFM Server InfiniBand Communication with HCAs

The UFM Server must be connected directly to the InfiniBand fabric. The UFM Server sends the standard InfiniBand Management Datagrams (MADs) to the Host Card Adapters (HCAs) and receives InfiniBand traps.

2.4.3.2 UFM Server Communication with InfiniBand Hosts

Affected Service	Network	Address / Service / Port	Direction
InfiniBand Management / Monitoring	InfiniBand	Management Datagrams	Bi-directional

2.4.4 UFM Server High Availability (HA) Active–Standby Communication

UFM Server HA Active–Standby Communication

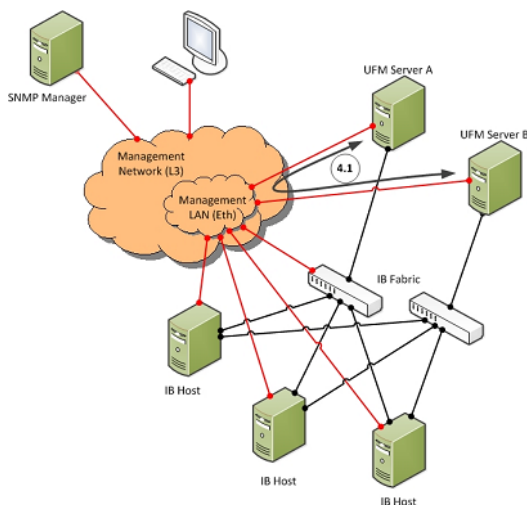

2.4.4.1 UFM Server HA Active–Standby Communication

UFM Active–Standby communication enables two services: heartbeat and DRBD.

- *heartbeat* is used for auto-negotiation and keep-alive messaging between active and standby servers. *heartbeat* uses port 694 (udp).
- DRBD is used for low-level data (disk) synchronization between active and standby servers. DRBD uses port 8888 (tcp).

Affected Service	Network	Address / Service / Port	Direction
UFM HA heartbeat	Out-of-band management*	UDP / 694	Bi-directional
UFM HA DRBD	Out-of-band management*	TCP / 8888	Bi-directional

*An IPoIB network can be used for HA, but this is not recommended, since any InfiniBand failure might cause split brain and lack of synchronization between the active and standby servers.

2.5 UFM Software Architecture

The following figure shows the UFM high-level software architecture with the main software components and protocols. Only the main logical functional blocks are displayed and do not necessarily correspond to system processes and threads.

UFM High-Level Software Architecture

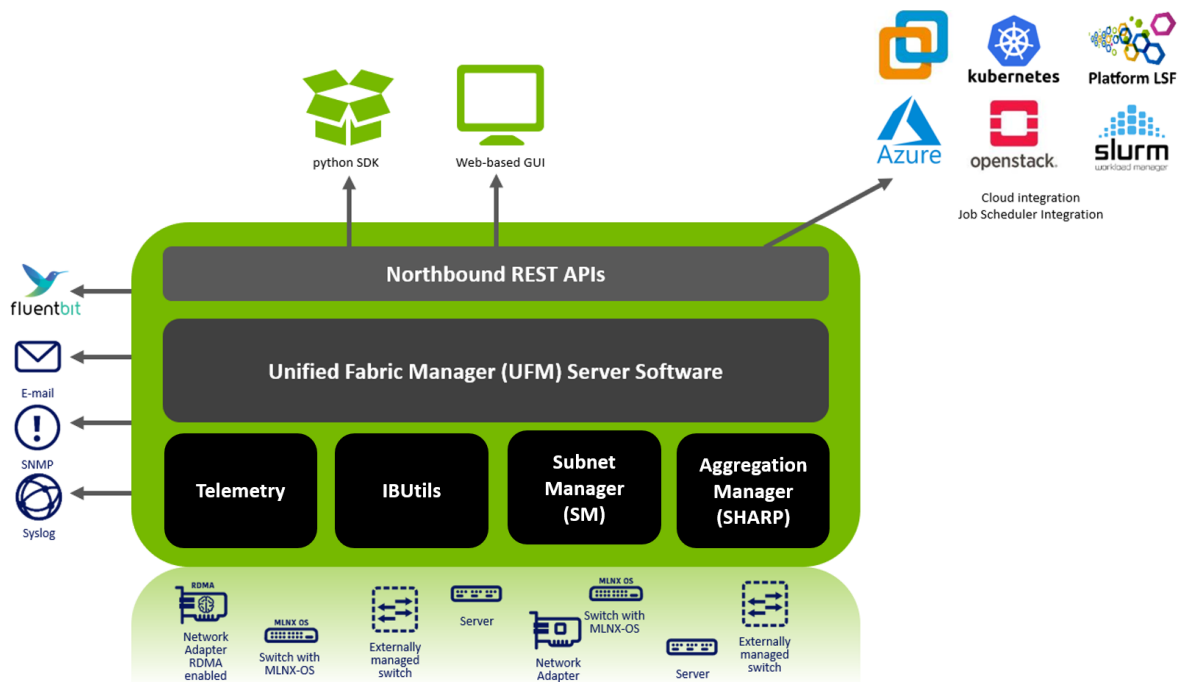

2.5.1 Graphical User Interface

UFM User Interface is a web application based on JavaScript and Angular JS, which is supported by any Web Browser. The Web application uses a standard REST API provided by the UFM server.

2.5.2 Client Tier API

Third-party clients are managed by the REST API.

2.5.3 Client Tier SDK Tools

Support for UFM's API and a set of tools that enhance UFM functionality and interoperability with third-party applications are provided as part of UFM.

2.5.4 UFM Server

UFM server is a central data repository and management server that manages all physical and logical data. UFM-SDN Appliance receives all data from the Device and Network tiers and invokes Device and Network tier components for management and configuration tasks. UFM-SDN Appliance uses a database for data persistency. The UFM-SDN Appliance is built on the Python twisted framework.

2.5.5 Subnet Manager

Subnet Manager (SM) is the InfiniBand "Routing Engine", a key component used for fabric bring-up and routing management. UFM uses the Open Fabric community OpenSM Subnet Manager. UFM uses a plug-in API for runtime management and fabric data export.

2.5.6 NVIDIA Scalable Hierarchical Aggregation and Reduction Protocol (SHARP)[™] Aggregation Manager

NVIDIA Scalable Hierarchical Aggregation and Reduction Protocol (SHARP) is a technology that improves the performance of mathematical and machine learning applications by offloading collective operations from the CPU to the switch network.

Aggregation Manager (AM) is a key component of NVIDIA SHARP software, used for NVIDIA SHARP resources management.

For further information about NVIDIA SHARP AM, refer to [Appendix - NVIDIA SHARP Integration](#).

2.5.7 Performance Manager

The UFM Performance Manager component collects performance data from the managed fabric devices and sends the data to the UFM-SDN Appliance for fabric-wide analysis and display of the data.

2.5.8 Device Manager

The Device Manager implements the set of common device management tasks on various devices with varying management interfaces. The Device Manager uses SSH protocol and operates native device CLI (command-line interface) commands.

2.5.9 UFM Switch Agent

UFM Switch Agent is an integrated part of NVIDIA switch software. The agent supports system parameter discovery and device management functionality on switches.

2.5.10 Communication Protocols

UFM uses the following communication protocols:

- Web UI communicates with the UFM server utilizing Web Services carried on REST API.
- The UFM server communicates with the switch Agent located on managed switches by proprietary TCP/UDP-based discovery and monitoring protocol and SSH.
- Monitoring data is sent by the switch Agent to UFM server Listener by a proprietary TCP-based protocol.

2.6 Getting Familiar with UFM's Data Model

Overview of Data Model

UFM enables the fabric administrator to manage the fabric based on discovery data collected from the fabric. This data is mapped into model elements (objects) available to the end user via UFM REST API and UFM Web UI.

2.6.1 UFM Model Basics





The fabric managed by UFM consists of a set of physical and logical objects, including their connections. The Object Model has a hierarchical object-oriented tree structure with objects as the tree elements. Each object defines an abstraction for physical or logical fabric elements.

2.6.2 Physical Model

The Physical Model represents the physical resources and connectivity topology of the Network. UFM enables discovery, monitoring and configuration of the managed physical objects.

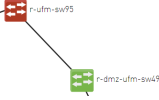
Physical Objects

Icon	Name	Description
N/A	Port Object	Represents the external physical port on switch or on Host Channel Adapter (HCA). A port is identified by its number. UFM provides InfiniBand standard management and monitoring capabilities on the port level.

Icon	Name	Description
N/A	Module Object	Represents the Field Removable Unit, Line card, and Network card on switch or HCA on host. For NVIDIA Switches, Line and Network Cards are modeled as modules.
	Link Object	Represents the physical connection between two active ports.
N/A	Cable Object	Represents the physical cable or the transceiver connected to one of the link edges.
	Computer Object	Represents the computer (host) connected to the Fabric. The UFM Agent installed on the host provides extended monitoring and management capabilities. Hosts without agents are limited to InfiniBand standard management and monitoring capabilities.
	Switch Object	Represents the switch chassis in the Fabric. A Switch object is created for every NVIDIA Switch. Switches of other vendors are represented as InfiniBand Switches and limited by InfiniBand standard management and monitoring capabilities.
	Rack Object	Represents the arbitrary group of switches or computers. When linked devices are shown as a group, the link is shown between the group and the peer object.

2.7 UFM Web UI Overview

The UFM Web User Interface (GUI) lets you access UFM through a web browser, where you can visualize your network and interact with the display using a keyboard and mouse.

The UFM WebUI is supported on Google Chrome and TBD. It is designed to be viewed on a display with a minimum resolution of 1920 × 1080 pixels.

- [Access the WebUI](#)
- [WebUI Layout](#)
- [Set User Preferences](#)

2.7.1 Access the WebUI

2.7.1.1 UFM Web UI Supported Browsers

UFM Web UI is supported on all the following web browsers: Internet Explorer, Firefox, Chrome and Opera.

For optimal UFM Web UI performance, make sure you are using the latest version available of Google Chrome.

For more information, see *UFM User Manual*.

2.7.1.2 Launching UFM Web UI Session

Before accessing the UFM Web UI:

- If required, you can change the configuration of the connection (port and protocol) between the UFM server and the APACHE server in the file *gv.cfg*:
 - *ws_protocol* = http or https
 - Setting the parameter *ws_protocol* to *http* allows unsecured access
 - Setting the parameter *ws_protocol* to *https* denies unsecured access.
 - *ws_port* = port number

➤ To launch a UFM Web UI session, do the following:

1. Launch the Web UI by entering the following URL in your browser:
http://<UFM_server_IP>/ufm
https://<UFM_server_IP>/ufm

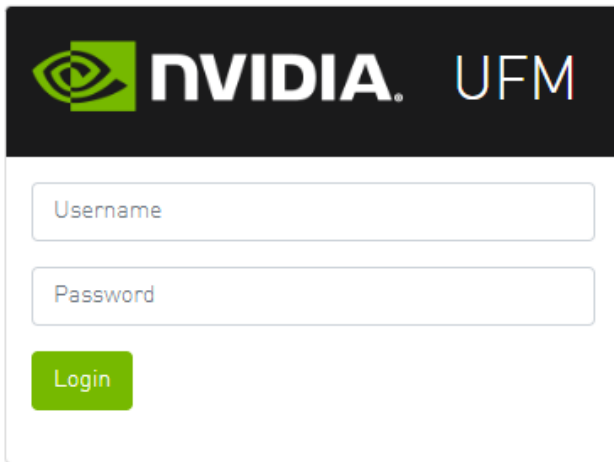

2. In the Login page, enter your User Name and your predefined user Password and click Login.

Once you have entered your user name and password, the main window shows the UFM Dashboard. For more information, see the [Fabric Dashboard](#).

2.7.2 WebUI Layout

The UFM WebUI contains two main areas:

1. Top Bar - Contains local time zone and user information on the top right side of the screen.
2. Sidebar Menu - Contains a taskbar accessible from a sidebar menu on the left side of the screen. For more information on each tab, refer to [UFM Web UI](#).

Sidebar Menu

Top Bar

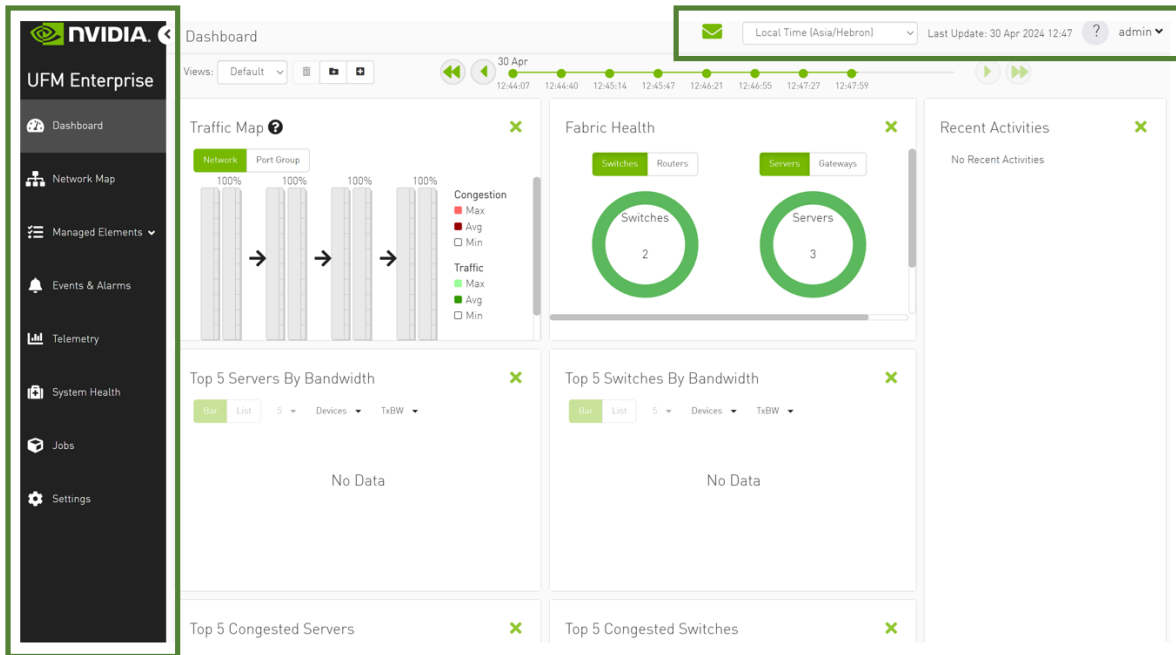





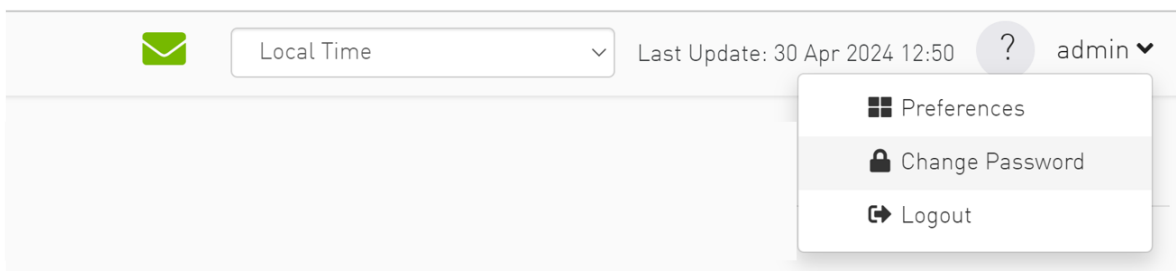



2.7.2.1 Top Bar

Each user can customize the UFM display, time zone, and date format, change their account password, and manage their preferences. For details, refer to [Set User Preferences](#).



2.7.2.2 Sidebar Menu

Tab Icon	Description
 Dashboard	Provides a summary view of the fabric status.
 Network Map	Provides a hierarchical topology view of the fabric.
 Managed Elements	Provides information on all fabric devices. This information is presented in a table format.

Tab Icon	Description
 Logical Elements	Provides information on all logical servers. This information is presented in a table format.
 Events & Alarms	Provides information on the events & alarms generated by the system.
 Telemetry	Enables establishing monitoring sessions on devices or ports.
 System Health	Enables running and viewing fabric reports, UFM reports, and system logs. You can also back up UFM configuration files.
 Jobs	Provides information on all jobs created, as a result of UFM actions.
 Settings	Enables configuring UFM server and UFM fabric settings, including events policy, device access, network management, subnet manager, and user management

2.7.3 Set User Preferences

This section describes how to customize your UFM display settings and change your password,

2.7.3.1 Dark/Light Theme

1. Select Preferences.

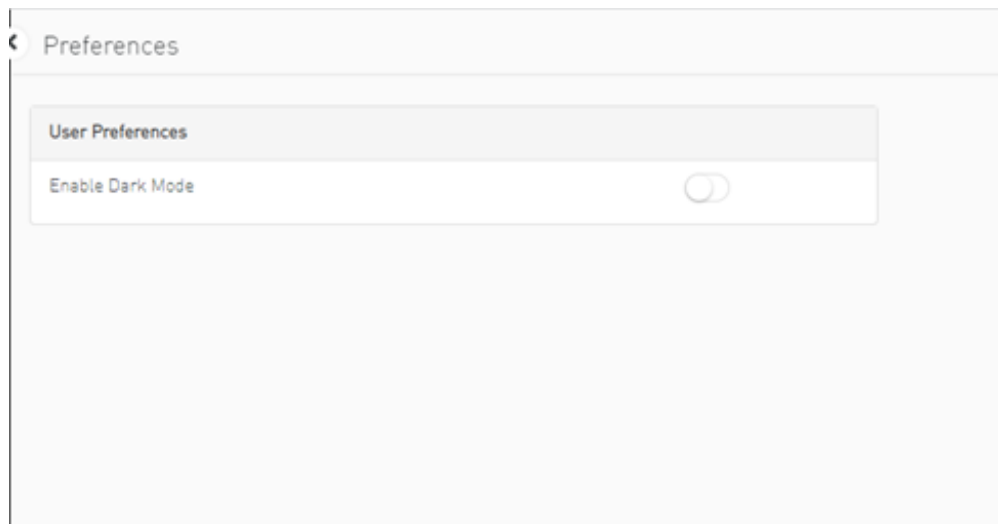

2. In User Preferences, enable dark mode for UFM presentation in a dark theme. The following figure shows the dark theme:

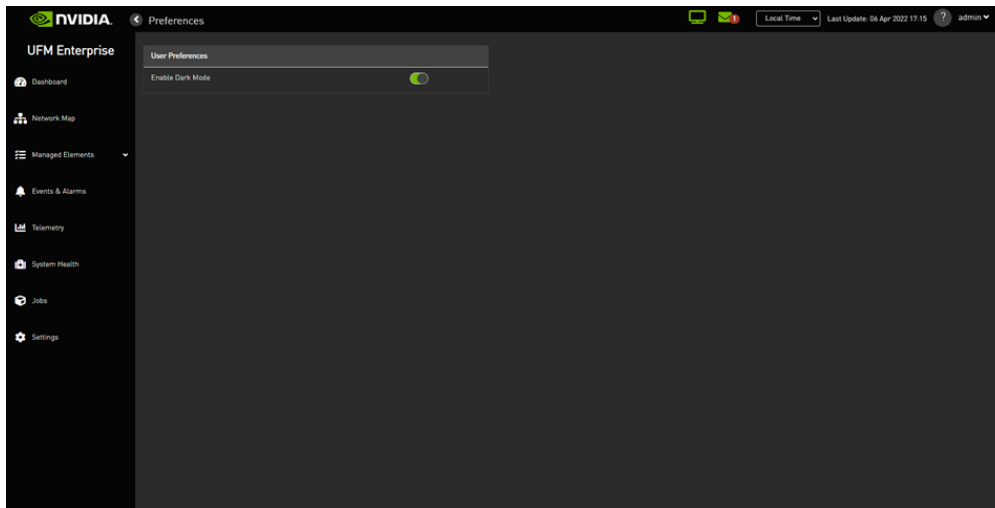

2.7.3.2 Time Zone Converter

Allows you to unify all times in UFM like events and alarms, ibdiagnet, telemetry and logs. You can switch between local and machine time.

In the status bar drop-down menu, switch between local and server/machine time.

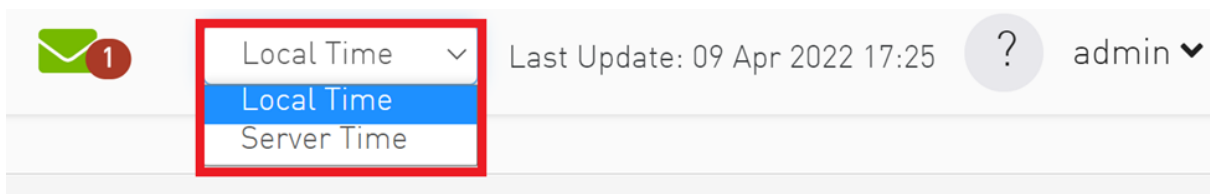

Events & Alarms Local Time Last Update: 09 Apr 2022 17:25 admin

Alarms

Clear All Alarms [refresh] Displayed Columns CSV

Severity	Date/Time ↓	Alarm Name	Source	Source Type	Reason	Count
Minor	2022-04-09 17:25:09	Non-optimal ...	default(3) / Switch: r-hyp-sw-01 /	IBPort	Found a [25.0] link that operates in [14.0] speed mode.	1180
Minor	2022-04-09 17:25:09	Non-optimal ...	default(3) / Switch: SwitchIB Mell	IBPort	Found a [25.0] link that operates in [14.0] speed mode.	1180
Minor	2022-04-09 17:25:09	Non-optimal ...	default(3) / Switch: SwitchIB Mell	IBPort	Found a [25.0] link that operates in [14.0] speed mode.	1180
Warning	2022-04-05 15:26:47	Unhealthy IB...	default(3) / Switch: r-hyp-sw-01 /	IBPort	Peer Port is considered by SM as unhealthy due to MANUAL.	1
Warning	2022-04-05 15:26:27	Unhealthy IB...	default(3) / Switch: SwitchIB Mell	IBPort	Peer Port is considered by SM as unhealthy due to MANUAL.	1

Events & Alarms Server Time Last Update: 09 Apr 2022 11:31 admin

Alarms

Clear All Alarms [refresh] Displayed Columns CSV

Severity	Date/Time ↓	Alarm Name	Source	Source Type	Reason	Count
Minor	2022-04-09 11:25:09	Non-optimal ...	default(3) / Switch: r-hyp-sw-01 /	IBPort	Found a [25.0] link that operates in [14.0] speed mode.	1180
Minor	2022-04-09 11:25:09	Non-optimal ...	default(3) / Switch: SwitchIB Mell	IBPort	Found a [25.0] link that operates in [14.0] speed mode.	1180
Minor	2022-04-09 11:25:09	Non-optimal ...	default(3) / Switch: SwitchIB Mell	IBPort	Found a [25.0] link that operates in [14.0] speed mode.	1180
Warning	2022-04-05 9:26:47	Unhealthy IB...	default(3) / Switch: r-hyp-sw-01 /	IBPort	Peer Port is considered by SM as unhealthy due to MANUAL.	1
Warning	2022-04-05 9:26:27	Unhealthy IB...	default(3) / Switch: SwitchIB Mell	IBPort	Peer Port is considered by SM as unhealthy due to MANUAL.	1

In the screenshots, the difference between Server Time and Local Time is 6 hours.

2.7.3.3 Table Enhancements

2.7.3.3.1 Look and Feel Improvements

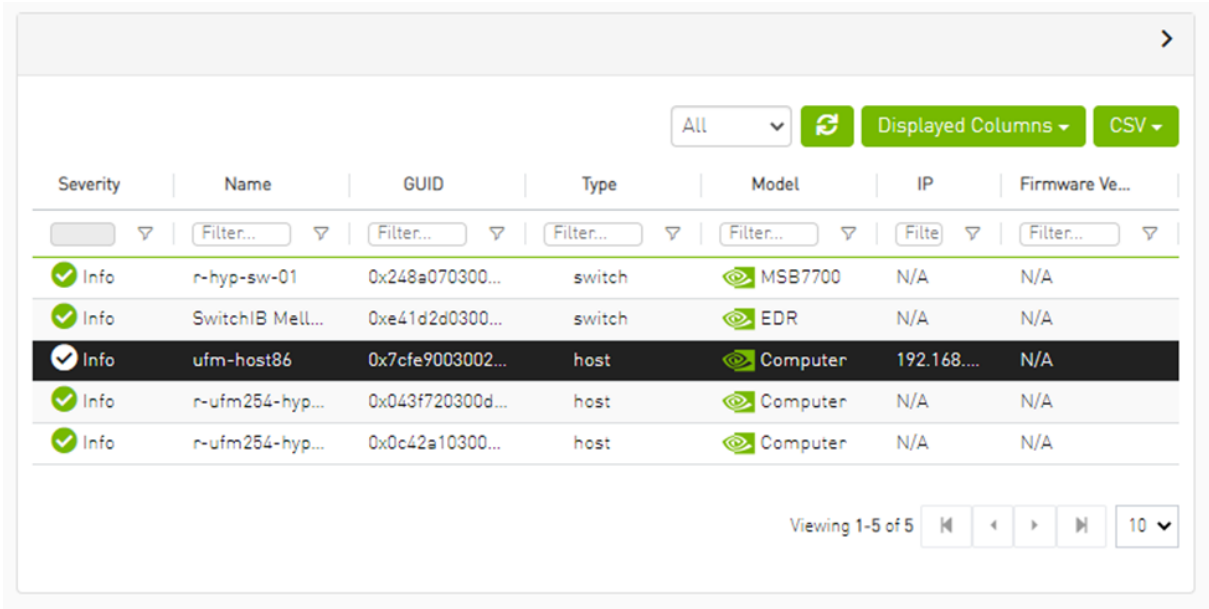

The screenshot shows a table with the following columns: Severity, Name, GUID, Type, Model, IP, and Firmware Ve... The table contains five rows of data. The third row is highlighted. Above the table, there are controls for 'All', 'Displayed Columns', and 'CSV'. Below the table, there is a pagination control showing 'Viewing 1-5 of 5' and a dropdown for '10'.

Severity	Name	GUID	Type	Model	IP	Firmware Ve...
Info	r-hyp-sw-01	0x248a070300...	switch	MSB7700	N/A	N/A
Info	SwitchIB Mell...	0xe41d2d0300...	switch	EDR	N/A	N/A
Info	ufm-host86	0x7cfe9003002...	host	Computer	192.168....	N/A
Info	r-ufm254-hyp...	0x043f720300d...	host	Computer	N/A	N/A
Info	r-ufm254-hyp...	0x0c42a10300...	host	Computer	N/A	N/A

2.7.3.3.2 Displayed Columns

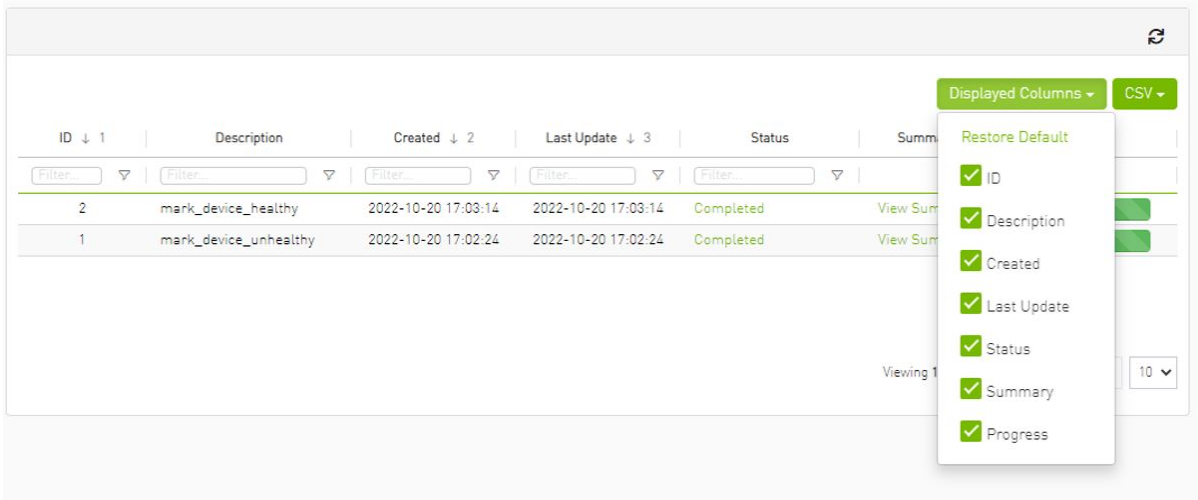

The screenshot shows a table with the following columns: ID, Description, Created, Last Update, Status, and Summary. The table contains two rows of data. A 'Displayed Columns' dropdown menu is open, showing a list of columns with checkboxes. The 'Progress' column is not checked.

ID	Description	Created	Last Update	Status	Summary
2	mark_device_healthy	2022-10-20 17:03:14	2022-10-20 17:03:14	Completed	View Summary
1	mark_device_unhealthy	2022-10-20 17:02:24	2022-10-20 17:02:24	Completed	View Summary

- Restore Default
- ID
- Description
- Created
- Last Update
- Status
- Summary
- Progress

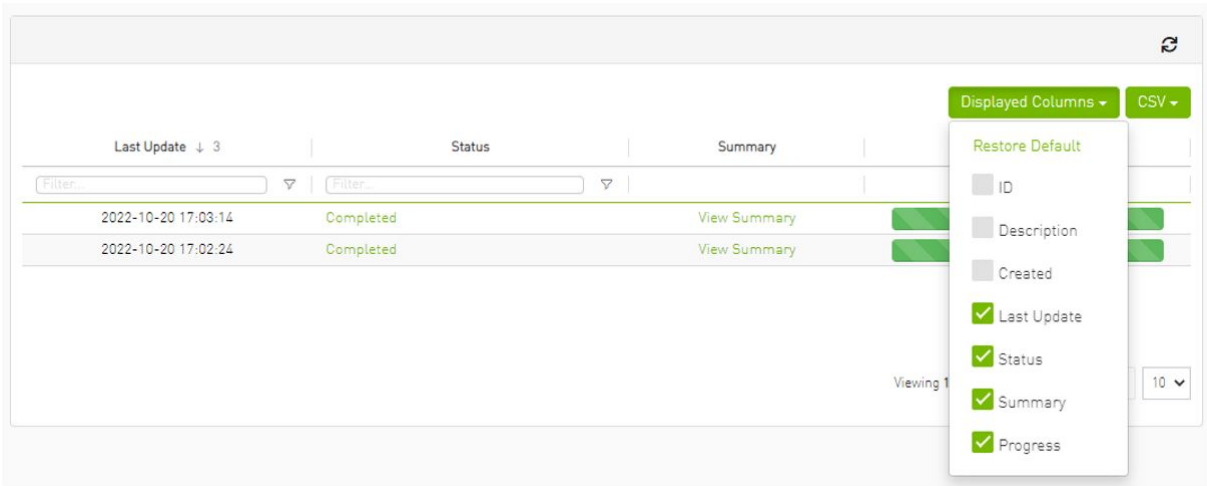

Displayed columns of all tables are persistent per user, with the option to restore defaults.

2.7.3.4 Export All Data as CSV

There are two options for exporting as CSV

- All Data: all data returned from server.
- Displayed Data: only displayed rows.

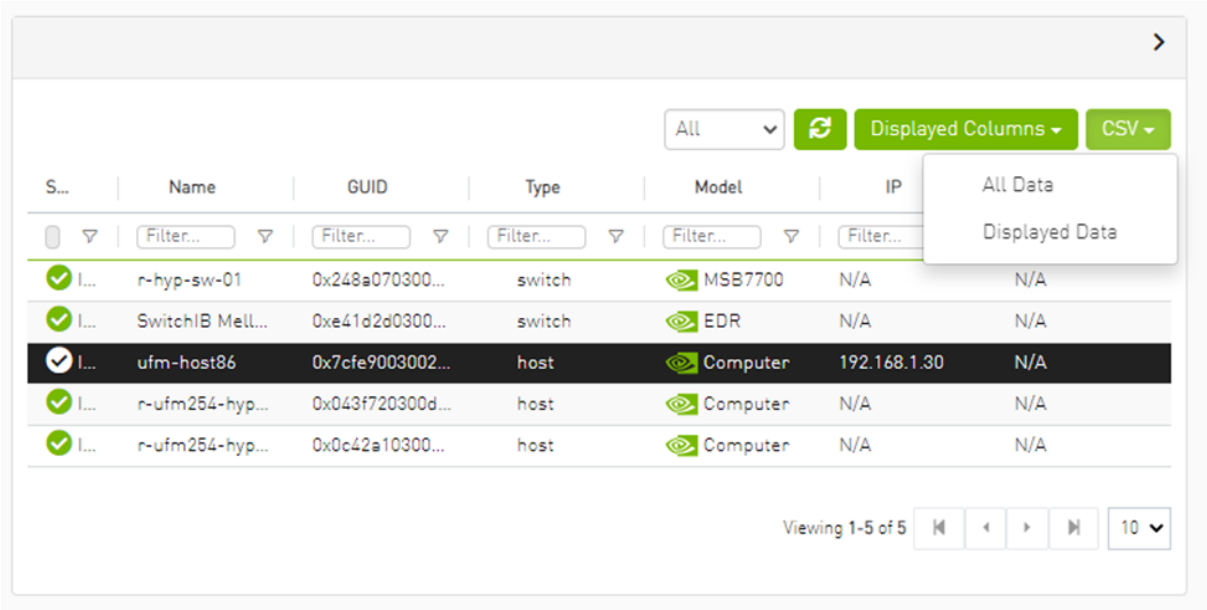

3 UFM Installation and Initial Configuration

UFM® software includes Server and Agent components. UFM Server software should be installed on a central management node. For optimal performance, and to minimize interference with other applications, it is recommended to use a dedicated server for UFM. The UFM Agent is an optional component and should be installed on fabric nodes. The UFM Agent should not be installed on the Management server.

The following sections provide step-by-step instructions for installing and activating the license file, installing the UFM server software, and installing the UFM Agent.

3.1 Prerequisites for UFM Server Software Installation

Please refer to [Installation Notes](#) for information on system prerequisites.

3.2 UFM Installation Steps

To install the UFM software:

1. [Download the UFM software and license file](#)
2. [Install the UFM Server Software](#) and [Activate the Software License](#)
3. [Perform initial configuration](#)
4. [Run the UFM server software](#)

3.3 UFM Installation Steps

- [Downloading UFM Software and License File](#)
- [Installing UFM Server Software](#)

3.3.1 Downloading UFM Software and License File

Before you obtain a license for the UFM® software, prepare a list of servers with the MAC address of each server on which you plan to install the UFM software. These MAC addresses are requested during the licensing procedure.

3.3.1.1 Obtaining License

UFM is licensed per managed device according to the UFM license agreement.

When you purchase UFM, you will receive an email with instructions on obtaining your product license. A valid UFM license is a prerequisite for the installation and operation of UFM.

UFM licenses are per managed node and are aggregative. If you install an additional license, the system adds the previous node number and the new node number and manages the sum of the nodes. For example, if you install a license for 10 managed nodes and an additional license for 15 nodes, UFM will be licensed for up to 25 managed nodes.

To obtain the license:

addresses.

Manage License File ✕

Make changes to the license allotment and generate a new file

ID	NAME	PROVISIONED	EXPIRATION
kvkdlxdbwy-tn0hcy2uud-cm0hiu4buu	UFM Enterprise Subs Licensing-1	20	Jun 16, 2022 - Jun 16, 2025

minx-ufm-kvkdlxdbwy-tn0hcy2uud-cm0hiu4buu-20220711143558.lic
license file generated Jul 11, 2022 5:37 PM last downloaded Jul 11, 2022 5:37 PM

MAC Address

Secondary MAC Address (optional)

GENERATE LICENSE FILE **DOWNLOAD LICENSE FILE**

5. Click on Generate License File to create the license key file for the software.
6. Click on Download License File and save it on your local computer.

If you replace your NIC or UFM server, repeat the process of generating the license to set new MAC addresses. You can only regenerate a license two times. To regenerate the license after that, contact NVIDIA Sales Administration at enterprisesupport@nvidia.com.

3.3.1.2 Downloading UFM Software

Due to internal packaging incompatibility, this release has two different packages for each of the supported distributions:

- One for UFM deployments over MLNX_OFED 5.X (or newer)

Please make sure to use the UFM installation package compatible to your setup.

This software download process applies to software updates and first-time installation.

If you own the UFM Media Kit and this is your first-time installation, skip this section.

To download the UFM software:

1. Click on Software Downloads, filter the product family to UFM, and select the relevant version of the software. Click on Download.

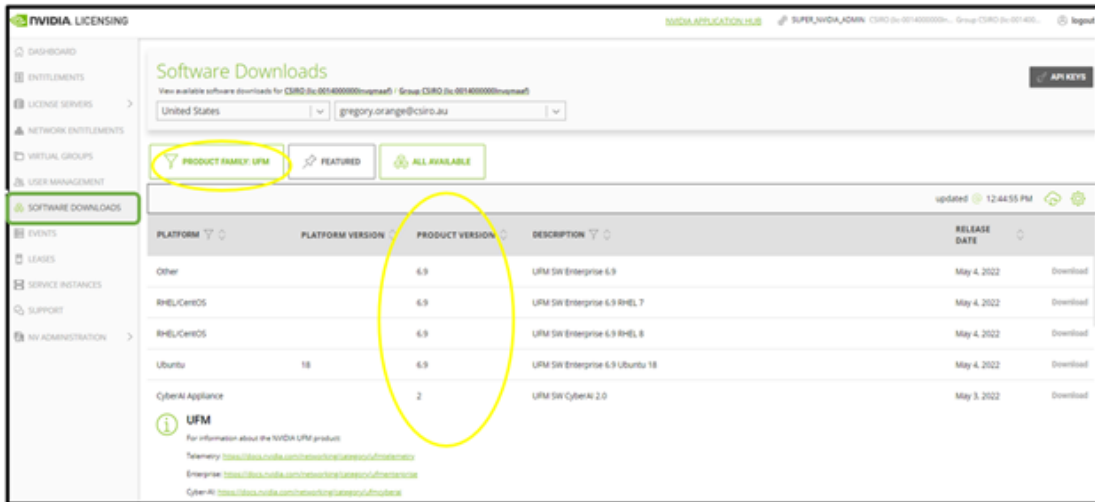

2. Save the file on your local drive.
3. Click Close.

3.3.2 Installing UFM Server Software

The default UFM® installation directory is `/opt/ufm`.

For instructions on installing the UFM server software, please refer to following instructions per desired installation mode.

- [Installing UFM Server on Bare Metal Server](#)
 - [Installing UFM on Bare Metal Server- Standalone Mode](#)
 - [Installing UFM on Bare Metal Server - High Availability Mode](#)
- [Installing UFM Docker Container Mode](#)
 - [Installing UFM on Docker Container - Standalone Mode](#)
 - [Installing UFM on Docker Container - High Availability Mode](#)

The following processes might be interrupted during the installation process:

- httpd (Apache2 in Ubuntu)
- dhcpd

To install UFM over static IPv4 configuration (instead of DHCP) please refer to [Configuring UFM Over Static IPv4 Address](#) before installation.

After installation:

1. Activate the software license
2. [Perform initial configuration](#)

Before you run UFM, ensure that all ports used by the UFM server for internal and external communication are open and available. For the list of ports, see [Appendix - Used Ports](#).

3.3.2.1 Prerequisites for UFM Server Software Installation

Verify that a supported version of Linux is installed on your machine. For details, see UFM System Requirements.

The following table lists the packages that must be installed on your machine (according to the system OS) before you install the UFM server software.

RedHat 7	RedHat 8	RedHat 9	Ubuntu 18.04	Ubuntu 20.04	Ubuntu 22.04
acl	acl	acl	acl	acl	acl
apr-util-openssl	apr-util-openssl	apr-util-openssl	apache2	apache2	apache2
bc	bc	bc	bc	bc	bc
cairo	gnutls	gnutls	chrpath	chrpath	chrpath
gnutls	httpd	httpd	cron	cron	cron
httpd	iptables	iptables-nft	gawk	gawk	gawk
iptables	jansson	jansson	lftp	lftp	lftp
lftp	lftp	lftp	libcurl4	libcurl4	libcurl4
libxml2	libnsl	libnsl	logrotate	logrotate	logrotate
libxslt	libxml2	libxml2	python3	python3	python3
mod_session	libxslt	libxslt	qperf	qperf	qperf
mod_ssl	mod_session	mod_session	rsync	rsync	rsync
net-snmp	mod_ssl	mod_ssl	snmpd	snmpd	snmpd
net-snmp-libs	net-snmp	net-snmp	sqlite3	sqlite3	sqlite3
net-snmp-utils	net-snmp-libs	net-snmp-libs	sshpass	sshpass	sshpass
net-tools	net-snmp-utils	net-snmp-utils	ssl-cert	ssl-cert	ssl-cert
php	net-tools	net-tools	sudo	sudo	sudo
psmisc	php	php	telnet	telnet	telnet
python3	psmisc	psmisc	zip	zip	zip
python3-libs	python36	python3			
qperf	qperf	qperf			
rsync	rsync	rsync			
sqlite	sqlite	sqlite			
sshpass	sshpass	sshpass			
sudo	sudo	sudo			
telnet	telnet	telnet			
zip	zip	zip			

On some Ubuntu OSs, Docker is installed via SNAP, which might lead to errors when trying to use UFM Plugins.

To solve this issue, perform the following:

1. Remove Docker installed via SNAP, run:

```
snap remove --purge docker
```

2. Update the local package index, run :

```
apt update
```

3. Install native Docker, run:

```
apt install-y docker.io
```

In addition, ensure the following before you begin installation:

- The computer hostname is not defined as 127.0.0.1 and localhost is defined as 127.0.0.1.
- The hostname must NOT appear on the loopback address line. An example of the loopback address is: 127.0.0.1 localhost.localdomain localhost.
- Disable the firewall service (`/etc/init.d/iptables stop`), or ensure that the required ports are open (see the prerequisite script, refer to [Used Ports](#)).
- Disable SELinux.
- If more than one fabric is managed by different UFM instances, set up different management network spaces for each fabric (not the same LAN).
- Uninstall any previously installed Subnet Manager from the UFM server machine.
- MLNX_OFED 5.x version is installed prior to installing UFM.
- As of UFM v.6.12.0, it is NOT mandatory to configure the IPoIB fabric interface with an IP address.

In cases where the IP is configured, it is mandatory that the IP is permanently configured and that it starts automatically upon server reboot (the IPoIB fabric interface should be active even if the network is down).

The user can set a persistent IP address using Netplan (mainly for Ubuntu systems) or modifying the interface network script (RedHat systems).

- The default MLNX_OFED installation includes opensm. Remove the MLNX_OFED opensm before UFM installation like the following examples:

RedHat:

```
rpm -e opensm-3.3.9.MLNX_20111006_e52d5fc-0.1
```

Ubuntu:

```
apt purge opensm
```

By default, ib0 and eth0 are configured as primary access points for the UFM management. If different management and/or InfiniBand interfaces (including bond interfaces) are used as

the primary access points, you should modify the configuration file by running the script `/opt/ufm/scripts/change_fabric_config.sh` as described in the section [Configuring General Settings](#) in `gv.cfg`.

Change the UFM Agent interface to the Ethernet and/or IPoIB interfaces used for communication with UFM Agent:

```
ufma_interfaces = ib0,eth0
```

3.3.2.2 Additional Prerequisites for UFM High Availability Installation

- Reliable and high-capacity out-of-band IP connectivity between the UFM Primary and Secondary servers (1 Gb Ethernet is recommended). This connectivity is used for DRBD synchronization.
- Format two identical servers with dedicated disk partitions for UFM replication. Since the UFM configuration file is replicated to the standby server, both master and standby servers must have the same interfaces.
- Allocate exactly the same size partition on both servers (master and slave) for the replicated data. See [UFM Server Requirements](#) for the recommended partition size. Partitions should not be mounted and must be zeroed (the file system should not be installed on the partitions). For disk partitioning, see the Linux user manual (`man fdisk`).
- We recommend establishing a passwordless SSH (via `/root/.ssh/authorized_keys` file) between the two servers before the installation.
- In fabrics consisting of multiple tiers of switches, it is recommended that the management ports (`ib0`) of the primary and secondary UFM server be connected to different fabric switches on the same tier (the outermost edge in CLOS 5 designs).

This is because by default, UFM manages the IB fabric via `ib0`, port 1 of the HCA. Failure or disconnect of `ib0`, the IB management port, causes a failure condition in UFM resulting in HA failover.

When the management ports (`ib0`) of the primary and secondary UFM server are connected to the same switch, a failure of this switch will result in a disconnect of both UFM servers from the fabric, and therefore UFM will not be able to manage the fabric.

Subnet Manager is running over the native InfiniBand layer, therefore bonding the IPoIB interfaces will not provide high availability. For additional information, please refer to [section UFM Failover to Another Port](#).

The UFM installation includes the InfiniBand Performance Management module (IBPM). This module is responsible for reporting performance information back to UFM and upper layer applications. When available, this process is offloaded to the non-management port (default `ib1`) of the UFM server. Failure or disconnect of the non-management port (`ib1`) on the primary UFM server will not cause UFM to failover. By default, the UFM Health Monitoring process is configured to try to restart the IBPM. For more information, see [UFM Health Configuration](#) in the UFM User Manual.

3.3.2.3 Installing UFM Server on Bare Metal Server

Installing UFM server on Bare Metal server can be done with the following modes:

- [Installing UFM on Bare Metal Server- Standalone Mode](#)
- [Installing UFM on Bare Metal Server - High Availability Mode](#)

3.3.2.3.1 Installing UFM on Bare Metal Server - High Availability Mode

Before installing UFM server software in High-Availability mode, ensure that the [Additional Prerequisites for UFM High Availability Installation](#) are met.

The UFM High-Availability configuration requires dual-link connectivity based on two separate interfaces between the two UFM HA nodes. This configuration comprises of a primary link that is exclusively reserved for DRBD operations and a secondary link designated for backup purposes. Crucially, it is imperative that communication between the servers is established in a bidirectional manner across both interfaces and validated through user-initiated testing, such as a 'ping' command or other suitable alternatives before HA configuration can be implemented. In cases where only one link is available among the two UFM HA nodes/servers, manually configure UFM with a single link. Refer to [Configure HA without SSH Trust \(Single Link Configuration\)](#).

UFM HA package requires a dedicated partition with the same name for DRBD on both servers. This guide uses `/dev/sda5` as an example.

1. On both servers, Install UFM Enterprise in Stand Alone (SA) mode.

Do not start UFM service.

2. Install the latest pcs and drbd-utils drivers on both servers.

For Ubuntu:

```
apt install pcs pacemaker drbd-utils
```

For CentOS/Red Hat:

```
yum install pcs pacemaker drbd84-utils kmod-drbd84
```

OR

```
yum install pcs pacemaker drbd90-utils kmod-drbd90
```

3. Download UFM-HA latest package from using this command:

Unable to render include or excerpt-include. Could not retrieve page.

For more information on the UFM-HA package and all installation and configuration options, please refer to [UFM High-Availability User Guide](#).

4. Extract the downloaded UFM-HA package on both servers under `/tmp/`.
5. Go to the directory you extracted `/tmp/ufm_ha_XXX` and run the installation script. For example, if your DRBD partition is `/dev/sda5` run:

```
./install.sh -l /opt/ufm/files/ -d /dev/sda5 -p enterprise
```

6. Configure the HA cluster. There are the three methods:

- [Configure HA with SSH Trust \(Dual Link Configuration\)](#) - Requires passwordless SSH connection between the servers.
- [Configure HA without SSH Trust \(Dual Link Configuration\)](#) - Does not require passwordless SSH connection between the servers, but asks you to run configuration commands on both servers.
- [Configure HA without SSH Trust \(Single Link Configuration\)](#) - Can be used in cases where only one link is available among the two UFM HA nodes/servers.

Configure HA with SSH Trust (Dual Link Configuration)

- a. On the master server only, configure the HA nodes. To do so, from /tmp, run the `configure_ha_nodes.sh` command as shown in the below example

```
configure_ha_nodes.sh \  
--cluster-password 12345678 \  
--master-primary-ip 10.10.10.1 \  
--standby-primary-ip 10.10.10.2 \  
--master-secondary-ip 192.168.10.1 \  
--standby-secondary -ip 192.168.10.2 \  
--no-vip
```

The script `configure_ha_nodes.sh` is located under `/usr/local/bin/`, therefore, by default, you do not need to use the full path to run it.

The `--cluster-password` must be at least 8 characters long.

To set up a Virtual IP for UFM and gain access to UFM through this IP, regardless of which server is running UFM, you may employ the `--no-vip` OR `--virtual-ip` command and provide an IP address as an argument. This can be achieved by navigating to `https://<Virtual-IP>/ufm` on your web browser.

When using back-to-back ports with local IP addresses for HA sync interfaces, ensure that you add your IP addresses and hostnames to the `/etc/hosts` file. This is needed to allow the HA configuration to resolve hostnames correctly based on the IP addresses you are using.

`configure_ha_nodes.sh` requires SSH connection to the standby server. If SSH trust is not configured, then you are prompted to enter the SSH password of the standby server during configuration runtime

- b. Depending on the size of your partition, wait for the configuration process to complete and DRBD sync to finish.

Configure HA without SSH Trust (Dual Link Configuration)

If you cannot establish an SSH trust between your HA servers, you can use `ufm_ha_cluster` directly to configure HA. To configure HA, follow the below instructions:

Please change the variables in the commands below based on your setup.

- a. [On Standby Server] Run the following command to configure Standby Server:

```
ufm_ha_cluster config -r standby \  
--local-primary-ip 10.10.50.1 \  
--peer-primary-ip 10.10.50.2 \  
--local-secondary-ip 192.168.10.1 \  
--peer-secondary-ip 192.168.10.2 \  
--hacluster-pwd 123456789 \  
--no-vip
```

- b. [On Master Server] Run the following command to configure Master Server:

```
ufm_ha_cluster config -r master --local-primary-ip 10.10.50.1 \  
--peer-primary-ip 10.10.50.2 \  
--local-secondary-ip 192.168.10.1 \  
--peer-secondary-ip 192.168.10.2 \  
--hacluster-pwd 123456789 \  
--no-vip
```

You must wait until after configuration for DRBD sync to finish, depending on the size of your partition. To check the DRBD sync status, run:

```
ufm_ha_cluster status
```

Configure HA without SSH Trust (Single Link Configuration)

This is not the recommended configuration and, in case of network failure, it might cause HA cluster split brain.

If you cannot establish an SSH trust between your HA servers, you can use `ufm_ha_cluster` directly to configure HA. To configure HA, follow the below instructions:

Please change the variables in the commands below based on your setup.

- a. [On Standby Server] Run the following command to configure Standby Server:

```
ufm_ha_cluster config \  
-r standby \  
-e 10.212.145.5 \  
-l 10.212.145.6 \  
--enable-single-link
```

- b. [On Master Server] Run the following command to configure Master Server:

```
ufm_ha_cluster config -r master \  
-e 10.212.145.6 \  
-l 10.212.145.5 \  
-i 10.212.145.50 \  
--enable-single-link
```

You must wait until after configuration for DRBD sync to finish, depending on the size of your partition. To check the DRBD sync status, run:

```
ufm_ha_cluster status
```

Starting HA Cluster

- To start UFM HA cluster:

```
ufm_ha_cluster start
```

- To check UFM HA cluster status:

```
ufm_ha_cluster status
```

Stopping UFM HA cluster:

```
ufm_ha_cluster stop
```

For complete details on high availability, refer to [NVIDIA UFM High-Availability User Guide](#).

3.3.2.3.2 Installing UFM on Bare Metal Server- Standalone Mode

To install the UFM server software as a standalone for InfiniBand:

1. Create a temporary directory (for example */tmp/ufm*).
2. Open the UFM software zip file that you downloaded. The zip file contains the following installation files:
 - RedHat 7/CentOS 7/OEL 7: *ufm-X.X-XXX.el7.x86_64.tgz*
 - RedHat 8/Centos 8: *ufm-X.X-XXX.el8.x86_64.tgz*
 - Ubuntu 18.04: *ufm-X.X-XXX.Ubuntu18.x86_64.tgz*
 - Ubuntu 20.04: *ufm-X.X-XXX.Ubuntu20.x86_64.tgz*
 - Ubuntu 22.04: *ufm-X.X-XXX.Ubuntu22.x86_64.tgz*
3. Extract the installation file for your system's OS to the temporary directory that you created.
4. From within the temporary directory, run the following command as root:

```
./install.sh
```

Running with the option "-o ib" is no longer required. For automatic installation, use the -q flag.

For "quiet" installation -q flag can be added (automatically answer yes for each question the installer asks).

Export `MULTISUBNET_CONSUMER=1` environment variable before running the installation script to install the UFM server in Multisubnet Consumer mode.

The UFM software is installed. You can now remove the temporary directory.

3.3.2.4 Installing UFM Docker Container Mode

3.3.2.4.1 General Prerequisites

- MLNX_OFED must be installed on the server that will run UFM Docker
- For UFM to work, you must have an InfiniBand port configured with an IP address and in "up" state.

For InfiniBand support, please refer to [NVIDIA Inbox Drivers](#), or MLNX_OFED guides.

- Make sure to stop the following services before running UFM Docker container, as it utilizes the same default ports that they do: Pacemaker, httpd, OpenSM, and Carbon.
- If firewall is running on the host, please make sure to add an allow rule for UFM used ports (listed below):

If the default ports used by UFM are changed in UFM configuration files, make sure to open the modified ports on the host firewall.

- 80 (TCP) and 443 (TCP) are used by WS clients (Apache Web Server)
- 8000 (UDP) is used by the UFM server to listen for REST API requests (redirected by Apache web server)
- 6306 (UDP) is used for multicast request communication with the latest UFM Agents
- 8005 (UDP) is used as a UFM monitoring listening port
- 8888 (TCP) is used by DRBD to communicate between the UFM Primary and Standby servers
- 2022 (TCP) is used for SSH

3.3.2.4.2 Prerequisites for Upgrading UFM Docker Container

- Supported versions for upgrade are UFM v.6.10.0 and above.
- UFM files directory from previous container version mounted on the host.

3.3.2.4.3 Step 1: Loading UFM Docker Image

To load the UFM docker image, pull the latest image from docker hub:

```
docker pull mellanox/ufm-enterprise:latest
```

You can see full usage screen for ufm-installation by running the container with `-h` or `-help` flag:

```
docker run --rm mellanox/ufm-enterprise-installer:latest -h
```

If an Internet connection is not available, perform the following:

- Copy the UFM image to your machine.

- Load the image from the file using this command:

```
docker image load -i <image-path>
```

3.3.2.4.4 Step 2: Installing UFM Docker

3.3.2.4.4.1 Installation Command Usage

```
docker run -it --name=ufm_installer --rm \
-v /var/run/docker.sock:/var/run/docker.sock \
-v /etc/systemd/system:/etc/systemd_files/ \
-v /opt/ufm/files:/installation/ufm_files/ \
-v [LICENSE_DIRECTORY]:/installation/ufm_licenses/ \
mellanox/ufm-enterprise:latest \
--install [OPTIONS]
```

Modify the variables in the installation command as follows:

- `[UFM_LICENSES_DIR]` : UFM license file or files location.

Example: If your license file or files are located under `/downloads/ufm_license_files/` then you must set this volume to be `-v /downloads/ufm_license_files:/installation/ufm_licenses/`

- `[OPTIONS]` : UFM installation options. For more details see the table below.

Command Options

Flag	Description	Default Value
<code>-f --fabric-interface</code>	IB fabric interface name.	ib0
<code>-g --mgmt-interface</code>	Management interface name.	eth0
<code>-h --help</code>	Show help	N/A
<code>-m --multisubnet-consumer</code>	UFM Multisubnet Consumer mode	N/A

3.3.2.4.5 Installation Modes

UFM Enterprise installer supports several deployment modes:

- [Installing UFM on Docker Container - High Availability Mode](#)
- [Installing UFM on Docker Container - Standalone Mode](#)

3.3.2.4.6 Installing UFM on Docker Container - High Availability Mode

3.3.2.4.6.1 Pre-deployments requirements

- Install pacemaker, pcs, and drbd-utils on both servers

For Ubuntu:

```
apt install pcs pacemaker drbd-utils
```

For CentOS/Red Hat:

```
yum install pcs pacemaker drbd84-utils kmod-drbd84
```

OR

```
yum install pcs pacemaker drbd90-utils kmod-drbd90
```

- A partition for DRBD on each server (with the same name on both servers) such as `/dev/sdd1`. Recommended partition size is 10-20 GB, otherwise DRBD sync will take a long time to complete.
- CLI command `hostname -i` must return the IP address of the management interface used for pacemaker sync correctly (update `/etc/hosts/` file with machine IP)
- Create the directory on each server under `/opt/ufm/files/` with read/write permissions on each server. This directory will be used by UFM to mount UFM files, and it will be synced by DRBD.

3.3.2.4.6.2 Installing UFM Containers

On the main server, install UFM Enterprise container with the command below:

```
docker run -it --name=ufm_installer --rm \  
-v /var/run/docker.sock:/var/run/docker.sock \  
-v /etc/systemd/system:/etc/systemd_files/ \  
-v /opt/ufm/files:/installation/ufm_files/ \  
-v /tmp/license_file:/installation/ufm_licenses/ \  
mellanox/ufm-enterprise:latest \  
--install
```

On the standby (secondary) server, install the UFM Enterprise container like the following example with the command below:

```
docker run -it --name=ufm_installer --rm \  
-v /var/run/docker.sock:/var/run/docker.sock \  
-v /etc/systemd/system:/etc/systemd_files/ \  
-v /opt/ufm/files:/installation/ufm_files/ \  
mellanox/ufm-enterprise:latest \  
--install
```

3.3.2.4.6.3 Downloading UFM HA Package

Download the UFM-HA package on both servers using the following command:

```
wget https://www.mellanox.com/downloads/UFM/ufm_ha_5.5.0-9.tgz
```

For Sha256:

```
wget https://download.nvidia.com/ufm/ufm_ha/ufm_ha_5.5.0-9.sha256
```

3.3.2.4.6.4 Installing UFM HA Package

For more information on the UFM-HA package and all installation and configuration options, please refer to [UFM High Availability User Guide](#).

1. [On Both Servers] Extract the downloaded UFM-HA package under /tmp/
2. [On Both Servers] Go to the extracted directory /tmp/ufm_ha_XXX and run the installation script. For example, if your DRBD partition is /dev/sda5 run the following command:

```
./install.sh -l /opt/ufm/files/ -d /dev/sda5 -p enterprise
```

3.3.2.4.6.5 Configuring UFM HA

There are the three methods to configure the HA cluster:

- [Configure HA with SSH Trust \(Dual Link Configuration\)](#) - Requires passwordless SSH connection between the servers.
- [Configure HA without SSH Trust \(Dual Link Configuration\)](#) - Does not require passwordless SSH connection between the servers, but asks you to run configuration commands on both servers.
- [Configure HA without SSH Trust \(Single Link Configuration\)](#) - Can be used in cases where only one link is available among the two UFM HA nodes/servers.

Configure HA with SSH Trust (**Dual Link Configuration**)

1. On the master server only, configure the HA nodes. To do so, from /tmp, run the `configure_ha_nodes.sh` command as shown in the below example

```
configure_ha_nodes.sh \  
--cluster-password 12345678 \  
--master-primary-ip 10.10.50.1 \  
--standby-primary-ip 10.10.50.2 \  
--master-secondary-ip 192.168.10.1 \  
--standby-secondary-ip 192.168.10.2 \  
--no-vip
```

The script `configure_ha_nodes.sh` is located under `/usr/local/bin/`, therefore, by default, you do not need to use the full path to run it.

The `--cluster-password` must be at least 8 characters long.

When using back-to-back ports with local IP addresses for HA sync interfaces, ensure that you add your IP addresses and hostnames to the `/etc/hosts` file. This is needed to allow the HA configuration to resolve hostnames correctly based on the IP addresses you are using.

`configure_ha_nodes.sh` requires SSH connection to the standby server. If SSH trust is not configured, then you are prompted to enter the SSH password of the standby server during configuration runtime

2. Depending on the size of your partition, wait for the configuration process to complete and DRBD sync to finish. To check the DRBD sync status, run:

```
ufm_ha_cluster status
```

Configure HA without SSH Trust (**Dual Link Configuration**)

If you cannot establish an SSH trust between your HA servers, you can use `ufm_ha_cluster` directly to configure HA. You can see all the options for configuring HA in the Help menu:

```
ufm_ha_cluster config -h
```

To configure HA, follow the below instructions:

Please change the variables in the commands below based on your setup.

1. [On Standby Server] Run the following command to configure Standby Server:

```
ufm_ha_cluster config -r standby -e <peer ip address> -l <local ip address> -p <cluster_password>
```

2. [On Master Server] Run the following command to configure Master Server:

```
ufm_ha_cluster config -r master -e <peer ip address> -l <local ip address> -p <cluster_password> -i <virtual ip address>
```

Configure HA without SSH Trust (Single Link Configuration)

This is not the recommended configuration and, in case of network failure, it might cause HA cluster split brain.

If you cannot establish an SSH trust between your HA servers, you can use `ufm_ha_cluster` directly to configure HA. To configure HA, follow the below instructions:

Please change the variables in the commands below based on your setup.

- a. [On Standby Server] Run the following command to configure Standby Server:

```
ufm_ha_cluster config \  
-r standby \  
-e 10.212.145.5 \  
-l 10.212.145.6 \  
--enable-single-link
```

- b. [On Master Server] Run the following command to configure Master Server:

```
ufm_ha_cluster config -r master \  
-e 10.212.145.6 \  
-l 10.212.145.5 \  
-i 10.212.145.50 \  
--enable-single-link
```

You must wait until after configuration for DRBD sync to finish, depending on the size of your partition. To check the DRBD sync status, run:

```
ufm_ha_cluster status
```

IPv6 Example:

```
ufm_ha_cluster config -r standby -l fcfc:fcfc:209:224:20c:29ff:fee7:d5f2 -e fcfc:fcfc:209:224:20c:29ff:feeb:4962 --enable-single-link -p some_secret
```

Starting HA Cluster

- To start UFM HA cluster:

```
ufm_ha_cluster start
```

- To check UFM HA cluster status:

```
ufm_ha_cluster status
```

- To stop UFM HA cluster:

```
ufm_ha_cluster stop
```

- To uninstall UFM HA, first stop the cluster and then run the uninstallation command as follows:

```
/opt/ufm/ufm_ha/uninstall_ha.sh
```

3.3.2.4.7 Installing UFM on Docker Container - Standalone Mode

1. Copy only your UFM license file(s) to a temporary directory which we're going to use in the installation command. For example: `/tmp/license_file/`
2. Run the UFM installation command according to the following example which will also configure UFM fabric interface to be `ib1`:

```
docker run -it --name=ufm_installer --rm \  
-v /var/run/docker.sock:/var/run/docker.sock \  
-v /etc/systemd/system:/etc/systemd_files/ \  
-v /opt/ufm/files:/installation/ufm_files/ \  
-v /tmp/license_file:/installation/ufm_licenses/ \  
mellanox/ufm-enterprise:latest \  
--install \  
--fabric-interface ib1
```

3. Reload systemd:

```
systemctl daemon-reload
```

4. To Start UFM Enterprise service run:

```
systemctl start ufm-enterprise
```

3.3.2.5 Replacing the Standby Node in HA Mode

3.3.2.5.1 Replacing the Standby Node

- Install the HA package for the new node (standby).
- Disconnect the standby node (the old standby) and run the following command on the master node:

```
ufm_ha_cluster detach
```

- Configure the new standby node; please refer to the relevant section depending on the installation
- Connect the new standby to the cluster by running the command on the master node:

```
ufm_ha_cluster attach -l <local primary ip address> -e <peer primary ip address> -E <peer secondary ip address> -p <clust
```

3.4 Activating Software License

1. Before starting the UFM software, copy your license file(s) downloaded from [NVIDIA Licensing and Download Portal](#) (*volt-ufm-
<serial-number>.lic*) to the master server under the */opt/ufm/files/licenses* directory. We recommend that you back up the license file(s). In High Availability mode, the license files are replicated to the standby machine automatically. Your software is now activated.
2. Run the UFM software as described in the following sections.

When a UFM license is not provided for activation upon the first UFM installation, the UFM runs on an auto-generated evaluation license which expires after 30 days from the first start-up of the UFM.

3.4.1 Licensing

1. After installing and activating your software, you can view your licenses in the Web UI by clicking the About icon (🌐) in the main window.

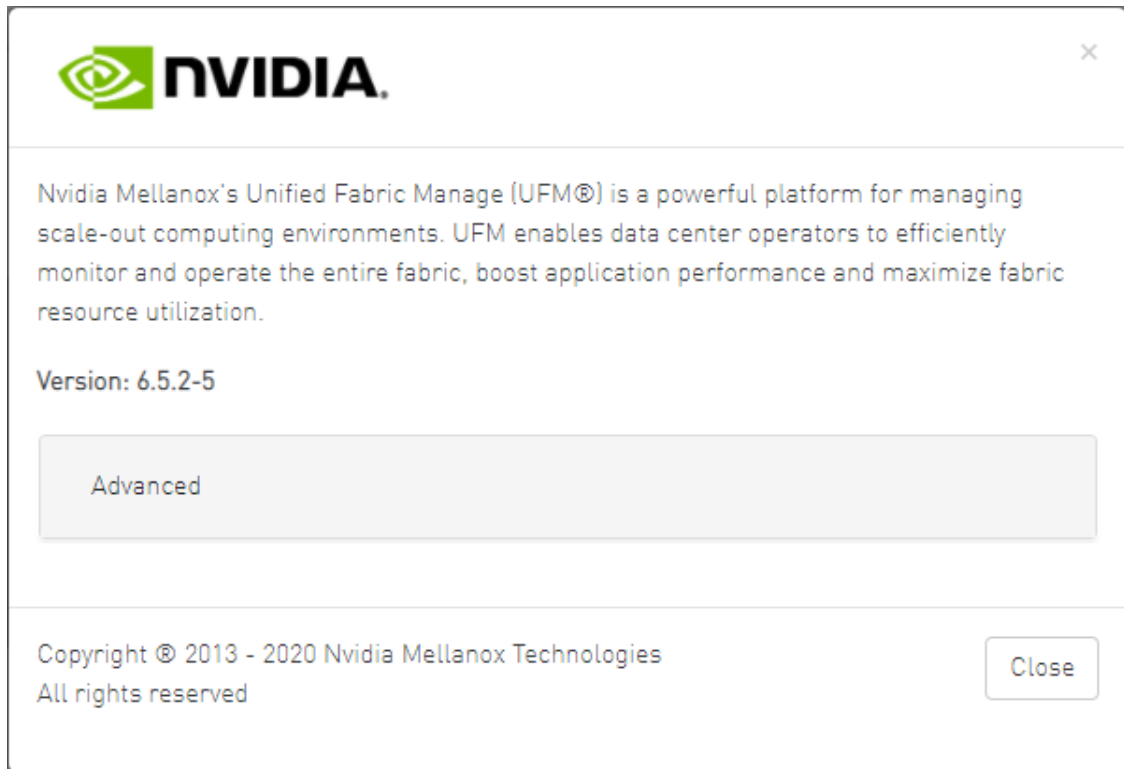

2. To view the advanced license information, click the Advanced button. The advanced license details will be displayed below.

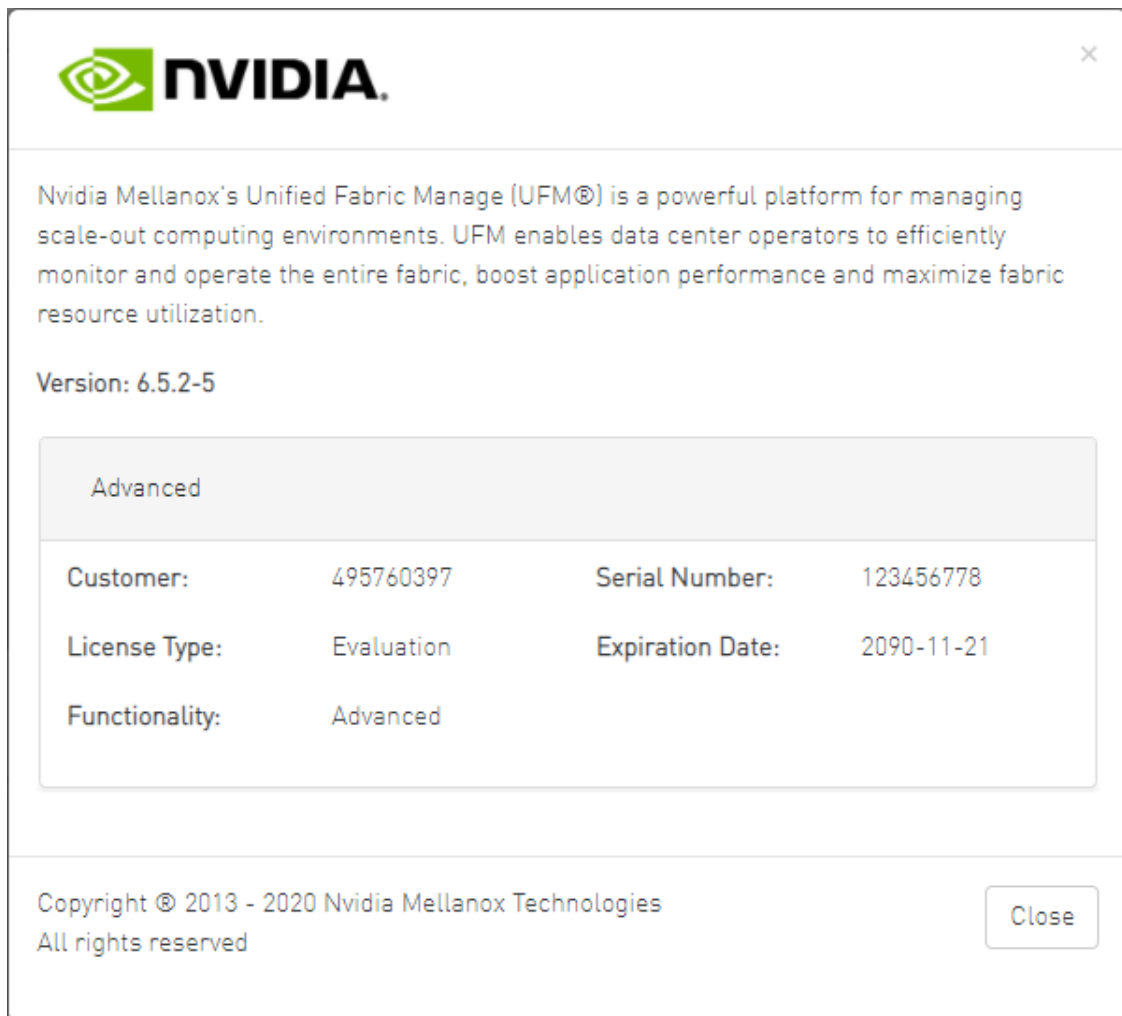

- Product Functionality is updated only after startup. If you replace the UFM license, UFM continues to work in the previous mode until the UFM server is restarted.

➤ To view license information from the CLI:

Run CLI Command "ufmlicense" to display information about all installed licenses on the UFM server under /opt/ufm/files/licenses. This includes invalid and expired license information.

There are two UFM HA licenses where each license includes 2 different MACs: one for the primary machine and one for the standby machine.

In a given time, for each license, only one MACs is detected to be "Valid" (exists on the local machine) where the other MAC is detected as "Invalid" (exist on the standby machine).

See below *output example when running the CLI command* `ufmlicense` in SA and HA Modes.

HA Mode Output Example:

```
[root@ip-10-224-16-49-dg11 ~]# docker exec -ti ufm bash
root@ ip-10-224-16-49-dg11~# ufmlicense
|-----|
|-----|
|NVIDIA Corp|xxxxxxx-xxxxxxx|UFM Enterprise|Subscription |e4:43:4b:18:3c:e0|2025-08-29 |128
|3 Years |Invalid |
|-----|
|-----|
|NVIDIA Corp|xxxxxxx-xxxxxxx|UFM Enterprise|Subscription |e4:43:4b:18:49:a0|2025-08-29 |128
|3 Years |Valid |
|-----|
|-----|
|NVIDIA Corp|xxxxxxx-xxxxxxx|UFM Enterprise|Subscription |e4:43:4b:18:3c:e0|2025-07-13 |128
|3 |Invalid |
|-----|
|-----|
|BBK Electronics Corp Ltd|xxxxxxx-xxxxxxx|UFM Enterprise|Subscription |e4:43:4b:18:49:a0|
2025-07-13 |128 |3 |Valid |
```

SA Mode Output Example:

```
root@ufm-production:~# ufmlicense
|-----|
| Customer ID | SN | swName | Type | MAC Address | Exp. Date | Limit |
|-----|
| 495760397 | 123456778 | UFM Enterprise | Evaluation | INA | 2090-11-21 | 1024 |
|-----|
| Advanced | Valid | | | | | |
|-----|
```

 To remove a license:

Delete the license file from /opt/ufm/files/licenses.

3.5 UFM Configuration

3.5.1 Initial Configuration

After installing the UFM® server software and before running UFM, perform the following:

- Mandatory Configuration:
 - Configure General Settings in gv.cfg
- [Additional Configurations](#) Options:
 - General Configuration options
 - Quality of Service
 - Activate and Enable Lossy Configuration Manager (Advanced License Only)
 - Activate and Enable Congestion Control Manager (Advanced License Only)

3.5.1.1 Configuring Fabric Interface

In most common cases, UFM is run in management mode; the UFM SM manages the InfiniBand fabric. In such cases, the only mandatory configuration is setting the fabric_interface parameter.

The fabric interface should be set to one of the InfiniBand IPoB interfaces, which connect the UFM/SM to the fabric:

```
fabric_interface = ib0
```

- By default, `fabric_interface` is set to `ib0`
- `fabric_interface` must be up and running before UFM startup. Otherwise, UFM will not be able to run.

For additional configuration options, please refer to the [Optional Configurations](#).

3.5.2 Optional Configurations

3.5.2.1 General Settings in `gv.cfg`

Configure general settings in the `conf/gv.cfg` file.

When running UFM in HA mode, the `gv.cfg` file is replicated to the standby server.

3.5.2.1.1 Enabling SHARP Aggregation Manager

SHARP Aggregation Manager is disabled by default. To enable it, set:

```
[Sharp]  
sharp_enabled = true
```

Upon startup of UFM or SHARP Aggregation Manager, UFM will resend all existing tenant allocations to SHARP AM.

3.5.2.1.2 Enabling Predefined Groups

```
enable_predefined_groups = true
```

By default, pre-defined groups are enabled. In very large-scale fabrics, pre-defined groups can be disabled in order to allow faster startup of UFM.

3.5.2.1.3 Enabling Multi-NIC Host Grouping

```
multinic_host_enabled = true
```

Upon first installation of UFM 6.4.1 and above, multi-NIC host grouping is enabled by default. However, if a user is upgrading from an older version, then this feature will be disabled for them.

It is recommended to set the value of this parameter before running UFM for the first time.

3.5.2.1.4 Defining Node Description Black-List

Node descriptions from the black-list should not be used for Multi-NIC grouping.

During the process of host reboot or initialization/bringup, the majority of HCAs receive a default label rather than an actual, real description. To prevent the formation of incorrect multi-NIC groups based on these default labels, this feature offers the option to establish a blacklist containing possible node descriptions that should be avoided when grouping Multi-NIC HCAs during host startup. Once a legitimate node description is assigned to the host, the HCAs are organized into multi-NIC hosts based on their respective descriptions. It is recommended to configure this parameter before initiating the UFM for the first time.

For instance, nodes initially identified with descriptions listed in the `exclude_multinic_desc` will not be initially included in Multi-NIC host groups until they obtain an updated, genuine node description.

Modify the `exclude_multinic_desc` parameter in the `cv.fg` file:

```
exclude_multinic_desc = localhost,generic_name_1,generic_name_2
```

3.5.2.1.5 Running UFM Over IPv6 Network Protocol

The default multicast address is configured to an IPv4 address. To run over IPv6, this must be changed to the following in section `UFMAgent` of `gv.cfg`.

```
[UFMAgent]
...
# if ufmagent works in ipv6 please set this multicast address to FF05:0:0:0:0:0:15F
mcast_addr = FF05:0:0:0:0:0:15F
```

3.5.2.1.6 Adding SM Plugin (e.g. `lossymgr`) to `event_plugin_name` Option

The following options allow users to set the SM plugin options via the UFM configuration. Once SM is started by UFM, it will start the SM plugin with the specified options.

```
# Event plugin name(s)
event_plugin_name osmfmpm lossymgr
```

Add the plug-in options file to the `event_plugin_options` option:

```
# Options string that would be passed to the plugin(s)
event_plugin_options --lossy_mgr -f <lossy_mgr-options-file-name>
```

These plug-in parameters are copied to the opensm.conf file in Management mode only.

3.5.2.1.7 Multi-port SM

SM can use up to eight-port interfaces for fabric configuration. These interfaces can be provided via `/opt/ufm/conf/gv.cfg`. The users can specify multiple IPoB interfaces or bond interfaces in `/opt/ufm/conf/gv.cfg`, subsequently, the UFM translates them to GUIDs and adds them to the SM configuration file (`/opt/ufm/conf/opensm/opensm.conf`). If users specify more than eight interfaces, the extra interfaces are ignored.

```
[Server]
# disabled (default) | enabled (configure opensm with multiple GUIDs) | ha_enabled (configure multiport SM with
high availability)
multi_port_sm = disabled
# When enabling multi_port_sm, specify here the additional fabric interfaces for OpenSM conf
# Example: ib1,ib2,ib5 (OpenSM will support the first 8 GUIDs where first GUID will
# be extracted the fabric_interface, and remaining GUIDs from additional_fabric_interfaces
additional_fabric_interfaces =
```

UFM treats bonds as a group of IPoB interfaces. So, for example, if bond0 consists of the interfaces ib4 and ib8, then expect to see GUIDs for ib4 and ib8 in opensm.conf.

Duplicate interface names are ignored (e.g. ib1,ib1,ib1,ib2,ib1 = ib1,ib2).

3.5.2.1.8 Configuring UDP Buffer

This section is relevant only in cases where `telemetry_provider=ibpm`. (By default, `telemetry_provider=telemetry`).

To work with large-scale fabrics, users should set the `set_udp_buffer` flag under the [IBPM] section to "yes" for the UFM to set the buffer size (default is "no").

```
# By default, UFM does not set the UDP buffer size. For large scale fabrics
# it is recommended to increase the buffer size to 4MB (4194304 bits).
set_udp_buffer = yes
# UDP buffer size
udp_buffer_size = 4194304
```

3.5.2.1.9 Virtualization

This allows for supporting virtual ports in UFM.

```
[Virtualization]
# By enabling this flag, UFM will discover all the virtual ports assigned for all hypervisors in the fabric
enable = false
# Interval for checking whether any virtual ports were changed in the fabric
interval = 60
```

3.5.2.1.10 Static SM LID

Users may configure a specific value for the SM LID so that the UFM SM uses it upon UFM startup.

```
[SubnetManager]
# 1- Zero value (Default): Disable static SM LID functionality and allow the SM to run with any LID.
```

```
# Example: sm_lid=0
# 2- Non-zero value: Enable static SM LID functionality so SM will use this LID upon UFM startup.
sm_lid=0
```

To configure an external SM (UFM server running in `sm_only` mode), users must manually configure the `opensm.conf` file (`/opt/ufm/conf/opensm/opensm.conf`) and align the value of `master_sm_lid` to the value used for `sm_lid` in `gv.cfg` on the main UFM server.

3.5.2.1.11 Configuring Log Rotation

This section enables setting up the log files rotate policy. By default, log rotation runs once a day by cron scheduler.

```
[logrotate]
#max_files specifies the number of times to rotate a file before it is deleted (this definition will be applied to
#SM and SHARP Aggregation Manager logs, running in the scope of UFM).
#A count of 0 (zero) means no copies are retained. A count of 15 means fifteen copies are retained (default is 15)
max_files = 15
#With max_size, the log file is rotated when the specified size is reached (this definition will be applied to
#SM and SHARP Aggregation Manager logs, running in the scope of UFM). Size may be specified in bytes (default),
#kilobytes (for example: 100k), or megabytes (for example: 10M). if not specified logs will be rotated once a day.
max_size = 3
```

3.5.2.1.12 Configuring UFM Logging

The [Logging] section in the `gv.cfg` enables setting the UFM logging configurations.

Field	Default Value	Value Options	Description
<code>level</code>	WARNING	CRITICAL, ERROR, WARNING, INFO, DEBUG	The definition of the maub logging level for UFM components.
<code>smclient_level</code>	WARNING	CRITICAL, ERROR, WARNING, INFO, DEBUG	The logging level for SM client log messages
<code>event_log_level</code>	INFO	CRITICAL, ERROR, WARNING, INFO, DEBUG	The logging level for UFM events log messages
<code>rest_log_level</code>	INFO	CRITICAL, ERROR, WARNING, INFO, DEBUG	Logging level for REST API related log messages
<code>authentication_service_log_level</code>	INFO	CRITICAL, ERROR, WARNING, INFO, DEBUG	logging level for UFM authentication log messages
<code>log_dir</code>	<code>/opt/ufm/files/log</code>	N/A	It is possible to change the default path to the UFM log directory. The configured <code>log_dir</code> must have read, write and execute permission for <code>ufmapp</code> user (<code>ufmapp</code> group). In case of HA, UFM should be located in the directory which is replicated between the UFM master and standby servers. A change of the default UFM log directory may affect UFM dump creation and inclusion of UFM logs in dump.

Field	Default Value	Value Options	Description
max_history_lines	100000	N/A	The maximum number of lines in log files to be shown in UI output for UFM logging.

```
[Logging]
# Optional logging levels: CRITICAL, ERROR, WARNING, INFO, DEBUG.
level = WARNING
smclient_level = WARNING
event_log_level = INFO
rest_log_level = INFO
authentication_service_log_level = INFO
# The configured log_dir must have read, write and execute permission for ufmapp user (ufmapp group).
log_dir = /opt/ufm/files/log
max_history_lines = 100000
```

3.5.2.1.13 Configuring UFM Over Static IPv4 Address

Follow this procedure to to run UFM on a static IP configuration instead of DHCP:

1. Modify the defined management Ethernet interface network script to be static. Run:

```
# vi /etc/sysconfig/network-scripts/ifcfg-enp1s0
```

Update the required interface with the static IP configuration (IP address, netmask, broadcast, and gateway):

```
NAME="enp1s0"DEVICE="enp1s0"
ONBOOT="yes"
BOOTPROTO="static"
IPADDR="10.209.37.153"
NETMASK="255.255.252.0"
BROADCAST="10.209.39.255"
GATEWAY="10.209.36.1"
TYPE=Ethernet
DEFROUTE="yes"
```

2. Add host entries to the /etc/hosts file. Run:

```
# vi /etc/hosts
127.0.0.1 localhost localhost.localdomain localhost4 localhost4.localdomain4
::1 localhost localhost.localdomain localhost6 localhost6.localdomain6
10.209.37.153 <hostname>
```

3. Check hostname. Run:

```
# vi /etc/hostname
<hostname>
```

4. Set up DNS resolution at /etc/resolv.conf. Run:

```
# vi /etc/resolv.conf
search mtr.labs.mlnx
nameserver 8.8.8.8
```

5. Restart network service. Run:

```
service network restart
```

6. Check Configuration. Run:

```
# hostname
```

```
<hostname>
# hostname -i
10.209.37.153
```

3.5.2.1.14 Configuring Syslog

This configuration enables the UFM to send log messages to syslog, including remote syslog. The configuration described below is located in the [Logging] section of the gv.cfg file.

Field	Default Value	Value Options	Description
syslog	false	True or False	Enables/disables UFM syslog option
syslog_addr	/dev/log # for remote rsyslog_hostname:514	N/A	<p>UFM syslog configuration (syslog_addr)</p> <p>For working with local syslog, set value to: /dev/log</p> <p>For working with external machine, set value to: host:port</p> <p>Important note: the default remote syslog server port is 514</p> <p>As the UFM log messages could be sent to remote server, change the rsyslog configuration on the remote server</p> <p>The /etc/rsyslog.conf file should be edited and two sections should be uncommented as shown below:</p> <pre># Provides UDP syslog reception \$ModLoad imudp \$UDPServerRun 514 # Provides TCP syslog reception \$ModLoad imtcp \$InputTCPServerRun 514</pre> <p>Restart the remote syslog service, run:</p> <pre>service rsyslog restart</pre>
ufm_syslog	false	True or False	Sets syslog option for main UFM process logging messages - False - Not to send. True: Send
smclient_syslog	false	True or False	Sets syslog option for OpenSM logging messages - False - Not to send. True: Send
event_syslog	false	True or False	Sets syslog option for events logging messages - False - Not to send. True: Send
rest_syslog	false	True or False	Sets syslog option for UFM REST API logging messages - False - Not to send. True: Send

Field	Default Value	Value Options	Description
authentication_syslog	false	True or False	Set syslog option for UFM authentication logging messages. False - Not to send. True: Send
syslog_level	WARNING	CRITICAL, ERROR, WARNING, INFO, DEBUG	Sets global syslog messages logging level. The syslog level is common for all the UFM components. The syslog level that is sent to syslog is the highest among the syslog level and component log level defined in the above section.
syslog_facility	LOG_USER	LOG_KERN, LOG_USER, LOG_MAIL, LOG_DAEMON, LOG_AUTH, LOG_SYSLOG, LOG_LPR, LOG_NEWS, LOG_UUCP, LOG_CRON, LOG_AUTHPRIV, LOG_FTP, LOG_NTP, LOG_SECURITY, LOG_CONSOLE, LOG_SOLCRON	Includes the remote syslog package header value for log message facility.

```

syslog = false
#syslog configuration (syslog_addr)
# For working with local syslog, set value to: /dev/log
# For working with external machine, set value to: host:port
syslog_addr = /dev/log
# The configured log_dir must have read, write and execute permission for ufmapp user (ufmapp group).
log_dir = /opt/ufm/files/log
# Main ufm log.
ufm_syslog = false
smclient_syslog = false
event_syslog = false
rest_syslog = false
authentication_syslog = false
syslog_level = WARNING
# Syslog facility. By default - LOG_USER
# possible facility codes: LOG_KERN,LOG_USER,LOG_MAIL,LOG_DAEMON,LOG_AUTH,LOG_SYSLOG,
# LOG_LPR,LOG_NEWS,LOG_UUCP,LOG_CRON,LOG_AUTHPRIV,LOG_FTP, LOG_NTP,LOG_SECURITY,LOG_CONSOLE,LOG_SOLCRON
# for reference https://en.wikipedia.org/wiki/Syslog
syslog_facility = LOG_USER

```

3.5.2.1.15 Excluding Unhealthy Ports from Fabric Health Report

In `gv.cfg` file there is a section named `UnhealthyPorts` and parameters in this section are used for unhealthy ports managing in UFM.

Unhealthy port state could be defined by used using UI or REST API request or reported by OpenSM or ibutilities.

UFM has an ability to check periodically fabric ports healthiness and to report unhealthy ports out or to perform automatically predefined isolation action for unhealthy ports.

In addition, using `exclude_unhealthy_ports` key in `UnhealthyPorts` section unhealthy ports could be excluded from ibdiagnet report.

By default, the value for this parameter is set as `false`. It means that unhealthy ports will appear in ibdiagnet reports, but if need to exclude unhealthy port from ibdiagnet reports

this parameter should be set to true and UFM server should be restarted so this action will take effect.

UFM starting flow will configure ibdiagnet configuration file with appropriate parameters and unhealthy ports will not appear in UFM health and Fabric health reports.

```
[UnhealthyPorts]
enable_ibdiagnet = true
log_level = INFO
syslog = false
# scheduling_mode possible values: fixed_time/interval.
# If fixed_time - ibdiagnet will run every 24 hours on the specified time - <fixed_time>.
# If interval - ibdiagnet will run first time after <start_delay> minutes from UFM startup and every <interval>
hours (default scheduling mode).
scheduling_mode = interval
# First ibdiagnet start delay interval (minutes)
start_delay = 5
# ibdiagnet run interval (hours)
interval = 3
# ibdiagnet run at a fixed time (example: 23:17:35)
fixed_time = 23:00:00
# By enabling this flag all the discovered high ber ports will be marked as unhealthy automatically by UFM
high_ber_ports_auto_isolation = false
# Auto isolation mode - which type of ports should be isolated.
# Options: switch-switch, switch-host, all (default: switch-switch).
auto_isolation_mode = switch-switch
# Trigger Partial Switch ASIC Failure whenever number of unhealthy ports exceed the defined percent of the total
number of the switch ports.
switch_asic_fault_threshold = 20
# exclude unhealthy ports from ibdiagnet reports
exclude_unhealthy_ports=false
```

3.5.2.1.16 Configuration Examples in gv.cfg

The following show examples of configuration settings in the gv.cfg file:

- Polling interval for Fabric Dashboard information

```
ui_polling_interval = 30
```

- [Optional] UFM Server local IP address resolution (by default, the UFM resolves the address by gethostip). UFM Web UI should have access to this address.

```
ws_address = <specific IP address>
```

- HTTP/HTTPS Port Configuration

```
# WebServices Protocol (http/https) and Port
ws_port = 8088
ws_protocol = http
```

- Connection (port and protocol) between the UFM server and the APACHE server

```
ws_protocol = <http or https>
ws_port = <port number>
```

For more information, see [Launching a UFM Web UI Session](#).

- SNMP `get-community` string for switches (fabric wide or per switch)

```
# default snmp access point for all devices
[SNMP]
port = 161
gcommunity = public
```

- Enhanced Event Management (Alarmed Devices Group)

```
[Server]
auto_remove_from_alerted = yes
```

- Log verbosity

```
[Logging]
# optional logging levels
#CRITICAL, ERROR, WARNING, INFO, DEBUG
level = INFO
```

For more information, see "[UFM Logs](#)".

- Settings for saving port counters to a CSV file

```
[CSV]
write_interval = 60
ext_ports_only = no
```

For more information, see "[Saving the Port Counters to a CSV File](#)".

- Max number of CSV files (UFM Advanced)

```
[CSV]
max_files = 1
```

For more information, see "[Saving Periodic Snapshots of the Fabric \(Advanced License Only\)](#)".

The access credentials that are defined in the following sections of the conf/gv.cfg file are used only for initialization:

- SSH_Server
- SSH_Switch
- TELNET
- IPMI
- SNMP
- MLNX_OS

To modify these access credentials, use the UFM Web UI. For more information, see "[Device Access](#)".

- Configuring the UFM communication protocol with MLNX-OS switches. The available protocols are:
 - http
 - https (default protocol for secure communication)

➤ *For configuring the UFM communication protocol after fresh installation and prior to the first run, set the MLNX-OS protocol as shown below.*

Example:

```
[MLNX_OS]
protocol = https
port = 443
```

Once UFM is started, all UFM communication with MLNX-OS switches will take place via the configured protocol.

- *For changing the UFM communication protocol while UFM is running, perform the following:*
1. Set the desired protocol of MLNX-OS in the conf/gv.cfg file (as shown in the example above).
 2. Restart UFM.

3. Update the MLNX-OS global access credentials configuration with the relevant protocol port. Refer to "[Device Access](#)" for help.
For the http protocol - default port is 80.
For the https protocol - default port is 443.
4. Update the MLNX-OS access credentials with the relevant port in all managed switches that have a valid IP address.

3.5.2.1.17 Managing Dynamic Telemetry

The management of dynamic telemetry instances involves the facilitation of user requests for the creation of multiple telemetry instances. As part of this process, the UFM enables users to establish new UFM Telemetry instances according to their preferred counters and configurations. These instances are not initiated by the UFM but rather are monitored for their operational status through the use of the UFM Telemetry bring-up tool

For more information on the supported REST APIs, please refer to [UFM Dynamic Telemetry Instances REST API](#).

The configuration parameters can be found in the gv.cfg configuration file under the DynamicTelemetry section.

Name	Description	Default value
max_instances	Maximum number of simultaneous running UFM Telemetries.	5
new_instance_delay	Delay time between the start of two UFM Telemetry instances, in minutes.	5
update_discovery_delay	The time to wait before updating the discovery file of each telemetry instance if the fabric has changed, in minutes.	10
endpoint_timeout	Telemetry endpoint timeout, in seconds.	5
bringup_timeout	Telemetry bringup tool timeout, in seconds.	60
initial_exposed_port	Initial port for the available range of ports (range(initial_exposed_port, initial_exposed_port + max_instances)).	9003
instances_sessions_compatibility_interval	Every instances_sessions_compatibility_interval minutes the UFM verifies compliance between instances and sessions to avoid zombie sessions. if 0 is configured this process won't be activate	10

3.5.2.1.18 SM Trap Handler Configuration

The SMTrap handler is the SOAP server that handles traps coming from OpenSM.

There are two configuration values related to this service:

- `osm_traps_debounce_interval` - defines the period the service holds incoming traps
- `osm_traps_throttle_val` - once `osm_traps_debounce_interval` elapses, the service transfers `osm_traps_throttle_val` to the Model Main

By default, the SM Trap Handler handles up to 1000 SM traps every 10 seconds.

3.5.2.1.19 Setting CPU Affinity on UFM

This feature allows setting the CPU affinity for the major processes of the UFM (such as ModelMain, SM, SHARP, Telemetry).

In order to increase the UFM's efficiency, the number of context-switches is reduced. When each major CPU is isolated, users can decrease the number of context-switches, and the performance is optimized.

The CPU affinity of these major processes is configured in the following two levels:

- Level 1- The major processes initiation.
- Level 2- Preceding initiation of the model's main subprocesses which automatically uses the configuration used in level 1 and designates a CPU for each of the sub-processes.

According to user configuration, each process is assigned with affinity.

By default, this feature is disabled. In order to activate the feature, configure

`Is_cpu_affinity_enabled` with true, check how many CPUs you have on the machine, and set the desired affinity for each process.

For example:

```
[CPUAffinity]
Is_cpu_affinity_enabled=true
Model_main_cpu_affinity=1-4
Sm_cpu_affinity=5-13
SHARP_cpu_affinity=14-22
Telemetry_cpu_affinity=22-23
```

The format should be a comma-separated list of CPUs. For example: 0,3,7-11.

The ModelMain should have four cores, and up to five cores. The SM should have as many cores as you can assign. You should isolate between the ModelMain cores and the SM cores.

SHARP can be assigned with the same affinity as the SM. The telemetry should be assigned with three to four CPUs.

3.5.2.1.20 Quality of Service (QoS) Support

Infiniband Quality of Service (QoS) is disabled by default in the UFM SM configuration file.

To enable it and benefit from its capabilities, set the qos flag to TRUE in the `/opt/ufm/files/conf/opensm/opensm.conf` file.

Example:

```
# Enable QoS setup
qos FALSE
```

The QoS parameters settings should be carefully reviewed before enablement of the qos flag. Especially, sl2vl and VL arbitration mappings should be correctly defined.

For information on Enhanced QoS, see [Appendix - SM Activity Report](#).

3.5.2.1.21 UFM Failover to Another Port

When the UFM Server is connected by two or more InfiniBand ports to the fabric, you can configure UFM Subnet Manager failover to one of the other ports. When failure is detected on an InfiniBand port or link, failover occurs without stopping the UFM Server or other related UFM services, such as mysql, http, DRDB, and so on. This failover process prevents failure in a standalone setup, and preempts failover in a High Availability setup, thereby saving downtime and recovery.

Network Configuration for Failover to IB Port

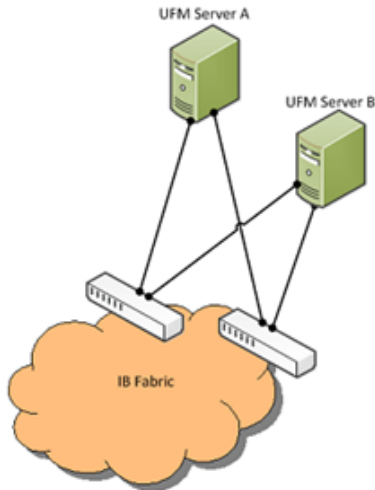

To enable UFM failover to another port:

- Configure bonding between the InfiniBand interfaces to be used for SM failover. In an HA setup, the UFM active server and the UFM standby server can be connected differently; but the bond name must be the same on both servers.
- Set the value of `fabric_interface` to the bond name. using the `/opt/ufm/scripts/change_fabric_config.sh` command as described in [Configuring General Settings in gv.cfg](#). If `ufma_interface` is configured for IPoIB, set it to the bond name as well. These changes will take effect only after a UFM restart. For example, if `bond0` is configured on the `ib0` and `ib1` interfaces, in `gv.cfg`, set the parameter `fabric_interface` to `bond0`.
- If IPoIB is used for UFM Agent, add `bond` to the `ufma_interfaces` list as well.

When failure is detected on an InfiniBand port or link, UFM initiates the give-up operation that is defined in the Health configuration file for OpenSM failure. By default:

- UFM discovers the other ports in the specified bond and fails over to the first interface that is up (SM failover)
If no interface is up:
 - In an HA setup, UFM initiates UFM failover
 - In a standalone setup, UFM does nothing

If the failed link becomes active again, UFM will select this link for the SM only after SM restart.

3.5.2.1.22 Configuring Managed Switches Info Persistency

UFM uses a periodic system information-pulling mechanism to query managed switches inventory data. The inventory information is saved in local JSON files for persistency and tracking of managed switches' status.

Upon UFM start up, UFM loads the saved JSON files to present them to the end user via REST API or UFM WebUI.

After UFM startup is completed, UFM pulls all managed switches data and updates the JSON file and the UFM model periodically (the interval is configurable). In addition, the JSON files are part of UFM system dump.

The following parameters allow configuration of the feature via `gv.cfg` file:

```
[SrvMgmt]
# how often UFM should send json requests for sysinfo to switches (in seconds)
systems_poll = 180
# To create UFM model in large setups might take a lot of time.
# This is an initial delay (in minutes) before starting to pull sysinfo from switches.
systems_poll_init_timeout = 5
# to avoid sysinfo dump overloading and multiple writing to host
# switches sysinfo will be dumped to disc in json format every set in this variable
# sysinfo request. If set to 0 - will not be dumped, if set to 1 - will be dumped every sysinfo request
# this case (as example defined below) dump will be created every fifth sysinfo request, so if system_poll is 180
# sec (3 minutes) sysinfo dump to the file will e performed every 15 minutes.
sysinfo_dump_interval = 5
# location of the sysinfo dump file (it is in /opt/ufm/files/logs (it will be part of UFM dump)
sysinfo_dump_file_path = /opt/ufm/files/log/sysinfo.dump
```

3.5.2.1.23 Configuring Partial Switch ASIC Failure Events

UFM can identify switch ASIC failure by detecting pre-defined portion of the switch ports, reported as unhealthy. By default, this portion threshold is set to 20% of the total switch ports. Thus, the UFM will trigger the partial switch ASIC event in case the number of unhealthy switch ports exceeds 20% of the total switch ports.

You can configure UFM to control Partial Switch ASIC Failure events. To configure, you may use the `gv.cfg` file by updating the value of `switch_asic_fault_threshold` parameter under the UnhealthyPorts section. For an example, in case the switch has 32 ports, once 7 ports are detected as unhealthy ports, the UFM will trigger the partial switch ASIC event. Example:

Warning	2023-01-25 10:41:22	Unhealthy IB Port	default(2) / Switch: sw-ufm-gr	IBPort	Peer Port is considered by SM as unhealthy due to MANUAL.
Warning	2023-01-25 10:41:02	Unhealthy IB Port	default(2) / Switch: sw-ufm-gr	IBPort	Peer Port "r-ufm51 HCA-1" is considered by SM as unhealthy due to MANUAL.
Critical	2023-01-25 10:41:02	Partial Switch ASIC Failure	default / Switch: sw-ufm-qm0	Switch	Number of switch unhealthy ports has been exceeded the defined threshold which is (4) perce
Info	2023-01-25 10:40:43	MCast Group Deleted	default(2)	Site	Mcast group is deleted: ff12601bffff0000, 1ff18fe80

3.5.2.1.24 Enabling Network Fast Recovery

To enable the Network Fast Recovery feature, ensure that all switches in the fabric use the following MLNX-OS/firmware versions:

- MLNX-OS version 3.10.6004 and up
- Quantum firmware versions:
 - Quantum FW v27.2010.6102 and up
 - Quantum2 FW v31.2010.6102 and up

Fast recovery is a switch-firmware based facility for isolation and mitigation of link-related issues. This system operates in a distributed manner, where each switch is programmed with a simple set of rule-based triggers (conditions) and corresponding action protocols. These rules permit the switch to promptly react to substandard links within its locality, responding at a very short reaction time - as little as approximately 100 milliseconds. The policy is provided and managed via the UFM and SM channel. Moreover, every autonomous action taken by a switch in the network is reported to the UFM.

The immediate reactions taken by the switch enable SHIELD and pFRN. These mechanisms collaborate to rectify routing within the proximity of the problematic link before it can disrupt transactions at the transport layer. Importantly, this process occurs rapidly, effectively limiting the spreading of congestion to a smaller segment of the network.

To use the Network Fast Recovery feature, you need to enable the designated trigger (condition) in the `gv.cfg` file. By doing this, you can specify which of the below four triggers the UFM will support.

As stated in the `gv.cfg` file, the feature is disabled by default and the below are the supported fields and options:

```
[NetworkFastRecovery]
# Fast Recovery configuration.
# Supported values:
# 0: Ignore fast recovery related MADs and configuration (default)
# 1: Disable fast recovery
# 2: Enable fast recovery
fast_recovery_mode = 0

# This will be supported by the Network Fast Recovery.
network_fast_recovery_conditions =
SWITCH_DECISION_CREDIT_WATCHDOG, SWITCH_DECISION_RAW_BER, SWITCH_DECISION_EFFECTIVE_BER, SWITCH_DECISION_SYMBOL_BER
```

To enable the Network Fast Recovery feature, the value of `fast_recovery_mode` should be set to 2. For the change to take effect, restart of UFM Enterprise is required.

The "Unhealthy Ports" page provides visibility of all unhealthy ports, including those triggered by the network fast recovery feature. If desired, the user can mark a port as healthy, triggering a restart of that specific port on the switch.

The trigger that initiated the isolation of ports can be viewed under the "Condition" column, as seen below.

Severity	Node	Port	GUID	Name	Port	GUID	LID	Condition	Status Time
Warning	smg-ib-sw012	smg-ib-sw012:16	0x043f720300695c6	smg-ib-sw056	smg-ib-sw056:117	0x900a8f030040c8...	17	SWITCH_DECISION...	Mon Mar 06 12:33:...

3.5.2.1.25 Disabling Rest Roles Access Control

By default, the Rest Roles Access Control feature is enabled. It can be disabled by setting the `roles_access_control_enabled` flag to false:

```
[RolesAccessControl]
roles_access_control_enabled = true
```

3.5.2.1.26 Enabling/Disabling Authentication

3.5.2.1.26.1 Kerberos Authentication

By default, [Kerberos Authentication](#) is disabled. To enable it, set the `kerberos_auth_enabled` flag to true. Additionally, provide the required configurations such as `kerberos_cred_key_path`, `kerberos_use_local_name` and `kerberos_auto_sign_up`.

```
[KerberosAuth]
# This section responsible to manage kerberos authentication
# Set to true to enable the kerberos auth feature, and set to false to disable it. Default is false.
kerberos_auth_enabled = false
# The path of the keytab file containing credentials for GSSAPI authentication.
kerberos_cred_key_path = /etc/kadm5.keytab
# Set to true to configure the Apache server to map authenticated principal names (which represent different
clients) to local usernames,
# and set to false to use the principle names as usernames. Default is true (this value will be reflected in the
'GssapiLocalName' directive in Apache).
kerberos_use_local_name = true
# Set to true to enable auto sign up of users who do not exist in UFM DB. Default is true.
kerberos_auto_sign_up = true
# The default role assigned to create users if they do not exist when 'kerberos_auto_sign_up' is set to true.
kerberos_default_role = System_Admin
```

`kerberos_auth_enabled`: By default, Kerberos authentication remains disabled. To activate it, the user must set this flag to 'true' and then restart UFM.

`kerberos_cred_key_path`: This specifies the path to the keytab file containing credentials for GSSAPI authentication.

`kerberos_use_local_name`: Set to true to configure the Apache server to map authenticated principal names (which represent different clients) to local usernames, and set to false to use the principal names as usernames. Default is true (this value will be reflected in the 'GssapiLocalName' directive in Apache).

`kerberos_auto_signup`: For successful authentication via Kerberos, the user must already exist within the UFM database, otherwise, the authentication will be refused by UFM. If this property is set to 'true,' UFM will create the non-existing users in the UFM DB.

`kerberos_default_role`: The default role is assigned to create users if they do not exist when 'kerberos_auto_sign_up' is set to true.

Finally, restart the UFM to use Kerberos authentication.

3.5.2.1.26.2 UFM Authentication Server

By default, [UFM Authentication Server](#) is enabled. To disable it, you need to set the "`auth_service_enabled`" parameter to 'false' and then restart the UFM service to initiate the authentication server. Additionally, you can use enable/disable flags for Basic, Session, and Token authentication:

```
[AuthService]
auth_service_enabled = true
auth_service_interface = 127.0.0.1
auth_service_port = 8087 # the serving port for the authentication server
basic_auth_enabled = true
session_auth_enabled = true
```

```
token_auth_enabled = true
```

3.5.2.1.26.3 Azure AD Authentication

By default, [Azure AD Authentication](#) is disabled. To enable it, set the `azure_auth_enabled` flag to 'true'. Additionally, provide the required configurations from the Azure AD Application such as TENANT_ID, CLIENT_ID and CLIENT_SECRET which can be found under the "Overview" section of the registered application in the Azure portal. Finally, the [UFM Authentication Server](#) should be enabled to use the Azure AD Authentication.

```
[AzureAuth]
azure_auth_enabled = false
# TENANT ID of app registration
TENANT_ID =
# Application (client) ID of app registration
CLIENT_ID =
# Application's generated client secret
CLIENT_SECRET =
```

3.5.2.1.27 UFM Configuration Files Based on Fabric Size

This function allows users to automate the process of updating the UFM configuration files by parsing a primary configuration file called `large_scale_subnet.cfg` file and applying the values to multiple target files or resetting to default values using the `small_scale_subnet.cfg`.

The below are instructions on how to use a Python script to parse a configuration file (`large_scale_subnet.cfg`) and update the values of specific parameters in multiple target UFM configuration files (`gv.cfg`, `reports.cfg`, `opensm.cfg`, and `sharp_am.cfg`). The script can operate in two modes:

- Large Scale Subnet Mode: This mode directly updates the UFM configuration files based on the parsed configuration from the `large_scale_subnet.cfg` file.
- Small Scale Subnet (Default) Mode: Sets the UFM configuration files to their default values by parsing the `small_scale_subnet.cfg` file.

3.5.2.1.27.1 Configuration File and Parameters

The primary configuration file contains all the parameters, and their values must be updated over the multiple UFM configuration files.

Primary Configuration Files

- `/opt/ufm/files/conf/ large_scale_subnet.cfg`
- `/opt/ufm/files/conf/ small_scale_subnet.cfg`

Target UFM Configuration Files

- `/opt/ufm/files/conf/gv.cfg`
- `/opt/ufm/files/conf/reports.cfg`
- `/opt/ufm/files/conf/opensm/opensm.conf`
- `/opt/ufm/files/conf/sharp/sharp_am.cfg`

Example structure of `large_scale_subnet.cfg` and `small_scale_subnet.cfg` :

```

[GV]
[GV.Server]
# disabled (default) | enabled (configure opensm with multiple GUIDs) | ha_enabled (configure multiport SM with
high availability).
multi_port_sm = ha_enabled
# report_events that will determine which trap to send to ufm all/security/none
report_events = security

[GV.FabricAnalysis]
# initial_delay (in minutes) - the initial delay for running fabric analysis for the first time after UFM was
started
initial_delay = 10

[GV.logrotate]
#max_files specifies the number of times to rotate a file before it is deleted.
#A count of 0 (zero) means no copies are retained. A count of 10 means fifteen copies are retained (default is 10)
max_files = 10

[REPORTS]
[REPORTS.FabricHealth]
# Fabric health report timeout
timeout = 1800

[REPORTS.TopologyCompare]
# Topology compare report timeout
timeout = 1800

[REPORTS.FabricAnalysis]
# Fabric analysis report timeout
timeout = 1800

[OPENSMS]
#Amount of physical port to handle in one shot
virt_max_ports_in_process = 512
max_op_vls = 2
qos = TRUE
# Single MAD S12vl for all ports
use_optimized_slvl = TRUE
# Timeout for long MAD config time. might need to change 1000
long_transaction_timeout = 500
routing_engine = ar_updn
use_ucast_cache = TRUE
root_guid_file = /opt/ufm/files/conf/opensm/root_guid.conf
pgrp_policy_file = /opt/ufm/files/conf/opensm/pgrp_policy.conf

[SHARP]
ib_qpc_sl = 1
fabric_update_interval = 10
lst_file_timeout = 10
lst_file_retries = 30
max_tree_radix = 80
generate_dump_files = TRUE
dynamic_tree_allocation = TRUE
dynamic_tree_algorithm = 1
smx_keepalive_interval = 10

```

Script Usage Example in the CLI:

- Large Scale Subnet Mode: `/opt/ufm/scripts/set_ufm_scale_profile.sh --mode large_scale_subnet --force_update`
- Small Scale Subnet (Default) Mode: `/opt/ufm/scripts/ set_ufm_scale_profile.sh --mode small_scale_subnet`

The `force_update` script parameter adds any parameters found in `large_scale_subnet.cfg` and `small_scale_subnet.cfg` that are not present in the UFM configuration files. For example, if a user adds a new parameter called `test_param = 500` to the `large_scale_subnet.cfg` file under the [Server] section and this parameter does not exist in the `gv.cfg` file, running the script with the `--force_update` option will add `test_param = 500` to the [Server] section of the `gv.cfg` file.

Expected Output

1. Large Scale Subnet Mode:

- The script reads `large_scale_subnet.cfg`.
- It updates the parameters in the target UFM configuration files based on the parsed data.
- It logs messages for any skipped parameters.

1. Small Scale Subnet - Default Mode:

- The script reads `small_scale_subnet.cfg`.
- It updates the parameters in the target UFM configuration files based on the parsed data.
- It logs messages for any skipped parameters or adds the parameter to the configuration file if the `force_update` was True.

Note: In case of the script running failure, the script will reset the UFM configuration files to their default values.

3.5.2.2 Setting up Telemetry in UFM

Setting up telemetry deploys UFM Telemetry as bare metal on the same machine. Historical data is sent to SQLite database on the server and live data becomes available via UFM UI or REST API.

3.5.2.2.1 Enabling UFM Telemetry

The UFM Telemetry feature is enabled by default and the provider is the UFM Telemetry. The user may change the provider via flag in `conf/gv.cfg`

The user may also disable the History Telemetry feature in the same section.

```
[Telemetry]
history_enabled=True
```

3.5.2.2.2 Changing UFM Telemetry Default Configuration

There is an option to configure parameters on a telemetry configuration file which takes effect after restarting the UFM or failover in HA mode. The `launch_ibdiagnet_config.ini` default file is located under `/opt/ufm/conf/telemetry_defaults` and is copied to the telemetry configuration location (`/opt/ufm/conf/telemetry`) upon startup UFM.

All values taken from the default file take effect at the deployed configuration file except for the following:

Note that normally the user does not have to do anything and they get two pre-configured instances - one for low frequency and one for higher-frequency sampling of the network.

Value	Description
<code>hca</code>	-
<code>scope_file</code>	-
<code>plugin_env_PROMETHEUS_ENDPOINT</code>	The port on which HTTP endpoint is configured

Value	Description
<code>plugin_env_PROMETHEUS_INDEXES</code>	Configures how data is indexed and stored in memory
<code>config_watch_enabled=true</code>	Configures network watcher to inform ibdiagnet that network topology has changed (as ibdiagnet lacks the ability to re-discover network changes)
<code>plugin_env_PROMETHEUS_CSET_DIR</code>	Specifies where the counterset files, which define the data to be retrieved and the corresponding counter names.
<code>num_iterations</code>	The number of iterations to run before 'restarting', i.e. rediscovering fabric.
<code>plugin_env_CLX_RESTART_FILE</code>	A file that is 'touched' to indicate that an ibdiagnet restart is necessary

The following attributes are configurable via the `gv.cfg`:

- `sample_rate` (`gv.cfg` → `dashboard_interval`) - only if `manual_config` is set to false
- `prometheus_port`

3.5.2.2.3 Supporting Generic Counters Parsing and Display

As of UFM v6.11.0, UFM can support any numeric counters from the HTTP endpoint. The list of supported counters are fetched upon starting the UFM from all the endpoints that are configured.

Some of the implemented changes are as follows:

1. Counter naming - all counters naming convention is extracted from the HTTP endpoint. The default `cset` file is configured as follows:
`" Infiniband_LinkIntegrityErrors=^LocalLinkIntegrityErrorsExtended$ "` to get this name to the UFM.
Counters received as floats should contain an "_f" suffix such as:
`Infiniband_CBW_f=^infiniband_CBW$`
2. Attribute units - To see units of a specific counter on the UI graphs, configure the `cset` file to have the counter returned as `" counter_name_u_unit "`.
3. Telemetry History:
The SQLite history table (`/opt/ufm/files/sqlite/ufm_telemetry.db - telemetry_calculated`), contains the new naming convention of the telemetry counters. In the case of an upgrade, all previous columns that were configured are renamed following the new naming convention, and then, the data is saved. if a new counter that is not in the table needs to be supported, the table is altered upon UFM start.
4. New counter/ `cset` to fetch - if there is a new `cset` /counter that needs to be supported AFTER the UFM already started, perform system restart.
5. Created New API/`UfmRestV2/telemetry/counters` for the UI visualization. This API returns a dictionary containing the counters that the UFM supports, based on the fetched URLs and their units (if known).

3.5.2.2.4 Supporting Multiple Telemetry Instances Fetch

This functionality allows users to establish distinct Telemetry endpoints that are defined to their preferences.

Users have the flexibility to set the following aspects:

- Specify a list of counters they wish to pull. This can be achieved by selecting from an existing, predefined counters set (`cset file`) or by defining a new one.
- Set the interval at which the data should be pulled.

Upon initiating the Telemetry endpoint, users can access the designated URL to fetch the desired counter data.

To enable this feature, under the [Telemetry] section in `gv.cfg`, the flag named

“ `additional_cset_url` ” holds the list of additional URLs to be fetched.

the URLs should be separated by “ ” (with a space) and should follow the following format: http://<IP>:<PORT>/csv/<CSET_NAME>. For example <http://10.10.10.10:9001/csv/minimal> <http://10.10.10.10:9002/csv/test>.

Only csv extensions are supported.

Each UFM Telemetry instance run by UFM can support multiple cset (counters set) in parallel. If the user would like to have a second cset file fetched by UFM and exposed by the same UFM Telemetry instance, the new cset file should be placed under `/opt/ufm/files/conf/telemetry/prometheus_configs/cset/` and configured in `gv.cfg` to fetch its data as described above.

3.5.2.2.5 Low-Frequency (Secondary) Telemetry

As a default configuration, a second UFM Telemetry instance runs, granting access to an extended set of counters that are not available in the default telemetry session. The default telemetry session is used for the UFM Web UI dashboard and user-defined telemetry views. These additional counters can be accessed via the following API endpoint: `http://<UFM_IP>:9002/csv/xcset/low_freq_debug`. It is important to note that these exposed counters are not accessible through UFM's REST APIs. All the configurations for the second telemetry can be found under `/opt/ufm/files/conf/secondary_telemetry/`, where the defaults are located under `/opt/ufm/files/conf/secondary_telemetry_defaults/`. The second telemetry instance also allows telemetry data to be exposed on disabled ports, although this feature can be disabled if desired.

The relevant flags in the `gv.cfg` file are as follows:

- `secondary_telemetry` = true (To enable or disable the entire feature)
- `secondary_endpoint_port` = 9002 (The endpoint's exposed port)
- `secondary_disabled_ports` = true (If set to true, secondary telemetry will expose data on disabled ports)
- `secondary_slvl_support` = false (if set to true, low-frequency (secondary) Telemetry will collect counters per slvl, the corresponding supported xcset can be found under `/opt/ufm/files/conf/secondary_telemetry/prometheus_configs/cset/low_freq_debug_per_slvl.xcset`)

The counters that are supported by default, collected, and exposed can be located in the directory `/opt/ufm/files/conf/secondary_telemetry/prometheus_configs/cset/low_freq_debug_per_slvl.xcset`.

For the list of low-frequency (secondary) telemetry fields and available counters, please refer to [Low-Frequency \(Secondary\) Telemetry Fields](#).

3.5.2.2.5.1 Low-Frequency (Secondary) Telemetry - Exposing IPv6 Counters

To allow the low-frequency (secondary) telemetry instance to expose counters on its IPv6 interfaces, perform the following:

1. Change the following flag in the gv.cfg:

```
secondary_ip_bind_addr =0:0:0:0:0:0:0:0
```

2. Restart UFM telemetry or restart UFM.

3.5.2.2.5.2 Stopping Telemetry Endpoint Using CLI Command

To stop low-frequency (secondary) telemetry endpoint only using the CLI you may run the following command:

```
/etc/init.d/ufmd ufm_telemetry_secondary_stop
```

3.5.2.2.5.3 Exposing Switch Aggregation Nodes Telemetry

To expose switches SHARP aggregation nodes telemetry, follow the below steps:

- Configure the low-frequency (secondary) telemetry instance. Run:

```
vi /opt/ufm/files/conf/secondary_telemetry_defaults/launch_ibdiagnet_config.ini
```

- Set the following:
 - `arg_16=--sharp --sharp_opt dsc`
 - `plugin_env_CLX_EXPORT_API_SKIP_SHARP_PM_COUNTERS=0`
- Add the wanted attributes to the default `xcset` or to a new one:
 - New `xcset` -

```
vi /opt/ufm/files/conf/secondary_telemetry/prometheus_configs/cset/<name for your choice>.xcset
```

- After restarting, query `curl http://<UFM_IP>:9002/csv/xcset/<chosen_name>`

- Existing `xcset` -

```
vi /opt/ufm/files/conf/secondary_telemetry/prometheus_configs/cset/low_freq_debug.xcset
```

- Add the following attributes:
 - `packet_sent`
 - `ack_packet_sent`
 - `retry_packet_sent`

- rnr_event
- timeout_event
- oos_nack_rcv
- rnr_nack_rcv
- packet_discard_transport
- packet_discard_sharp
- aeth_syndrome_ack_packet
- hba_sharp_lookup
- hba_received_pkts
- hba_received_bytes
- hba_sent_ack_packets
- rcds_sent_packets
- hba_sent_ack_bytes
- rcds_send_bytes
- hba_multi_packet_message_dropped_pkts
- hba_multi_packet_message_dropped_bytes
- Restart telemetry:

```
/etc/init.d/ufmd ufm_telemetry_stop
/etc/init.d/ufmd ufm_telemetry_start
```

3.5.2.2.5.4 Exposing Performance Histogram Counters for Egress Queue Depth Indications (Secondary) Telemetry

To enable the secondary telemetry instance to expose performance histogram counters for all VLs, perform the following:

1. Change the following flag in the `gv.cfg` file:

```
queue_depth_indications_all_vls = true
```

If this flag remains set to `false`, the secondary telemetry instance will only collect counters for VLs 0 and 1.

2. Restart UFM telemetry or restart UFM.

After the secondary telemetry instance restarts, you can find the collected counters at:

```
/opt/ufm/conf/secondary_telemetry/prometheus_configs/cset/low_freq_debug_per_slvl.xcset
```

3.6 Running UFM Server Software

Before running UFM:

- Perform [Initial Configuration](#)
- Ensure that all ports used by the UFM server for internal and external communication are open and available. For the list of ports, see [Used Ports](#).

You can run the UFM server software in the following modes:

- [Running UFM Server Software in Management Mode](#)
- [Running UFM Software in High Availability Mode](#)
- Running UFM in High Availability with failover to an external SM

In Management or High Availability mode, ensure that all Subnet Managers in the fabric are disabled *before* running UFM. Any remaining active Subnet Managers will prevent UFM from running.

3.6.1 Running UFM Server Software in Management Mode

After installing, run the UFM Server by invoking:

```
systemctl start ufm-enterprise.service
```

`/etc/init.d/ufmd` - Available for backward compatibility.

Log files are located under `/opt/ufm/files/log` (the links to log files are in `/opt/ufm/log`).

3.6.2 Running UFM Software in High Availability Mode

On the Master server, run the UFM Server by invoking:

```
ufm_ha_cluster start
```

You can specify additional command options for the `ufmha` service.

ufm_ha_cluster Command Options

Command	Description
start	Starts UFM HA cluster.
stop	Stops UFM HA cluster.
failover	Initiates failover (change mastership from local server to remote server).
takeover	Initiates takeover (change mastership from remote server to local server).
status	Shows current HA cluster status.
cleanup	Cleans the HA configurations on this node.
help	Displays help text.

3.6.3 HTTP/HTTPS Configuration

By default, UFM is configured to work with the secured HTTPS protocol.

After installation, the user can change the the Web Server configuration to communicate in secure (HTTPS) or non-secure (HTTP) protocol.

For changing the communication protocol, use the following parameter under the [Server] section in the `gv.cfg` file:

- `ws_protocol = https`

Changes will take effect after restarting UFM.

3.6.4 UFM Internal Web Server Configuration

UFM uses Apache as the main Web Server for client external access. The UFM uses an internal web server process to where the Apache forwards the incoming requests.

By default, the internal web server listens to the local host interface (127.0.0.1) on port 8000.

For changing the listening local interface or port, use the following parameters under the [Server] section in the `gv.cfg` file:

- `rest_interface = 127.0.0.1`
- `rest_port = 8000`

Changes will take effect after restarting UFM.

3.6.5 User Authentication

UFM User Authentication is based on standard Apache User Authentication. Each Web Service client application must authenticate against the UFM server to gain access to the system.

The UFM software comes with one predefined user:

- Username: admin
- Password: 123456

You can add, delete, or update users via [User Management Tab](#).

3.6.6 UFM Authentication Server

The UFM Authentication Server, a centralized HTTP server, is responsible for managing various authentication methods supported by UFM.

3.6.6.1 Configurations of the UFM Authentication Server

The UFM Authentication Server is designed to be configurable and is initially turned off by default. This means that existing authentication methods are managed either by the native Apache functionality (such as Basic, Session, and Client Certificate authentication) or at the UFM level (including Token-Based authentication and Proxy Authentication).

Enabling the UFM Authentication Server provides a centralized service that oversees all supported authentication methods within a single service, consolidating them under a unified authentication API.

Apache utilizes the authentication server's APIs to determine a user's authentication status.

To enable the UFM Authentication Server, refer to [Enabling UFM Authentication Server](#).

All activities of the UFM Authentication Server are logged in the `authentication_service.log` file, located at `/opt/ufm/files/log`.

3.6.7 Azure AD Authentication

Microsoft Azure Authentication is a service provided by Microsoft Azure, the cloud computing platform of Microsoft. It is designed to provide secure access control and authentication for applications and services hosted on Azure.

UFM supports Authentication using Azure Active Directory, and to do so, you need to follow the following steps:

3.6.7.1 Register UFM in Azure AD Portal

To log in via Azure, UFM must be registered in the Azure portal using the following steps:

1. Log in to [Azure Portal](#), then click "Azure Active Directory" in the side menu.
2. If you have access to more than one tenant, select your account in the upper right. Set your session to the Azure AD tenant you wish to use.
3. Under "Manage" in the side menu, click App Registrations > New Registration.

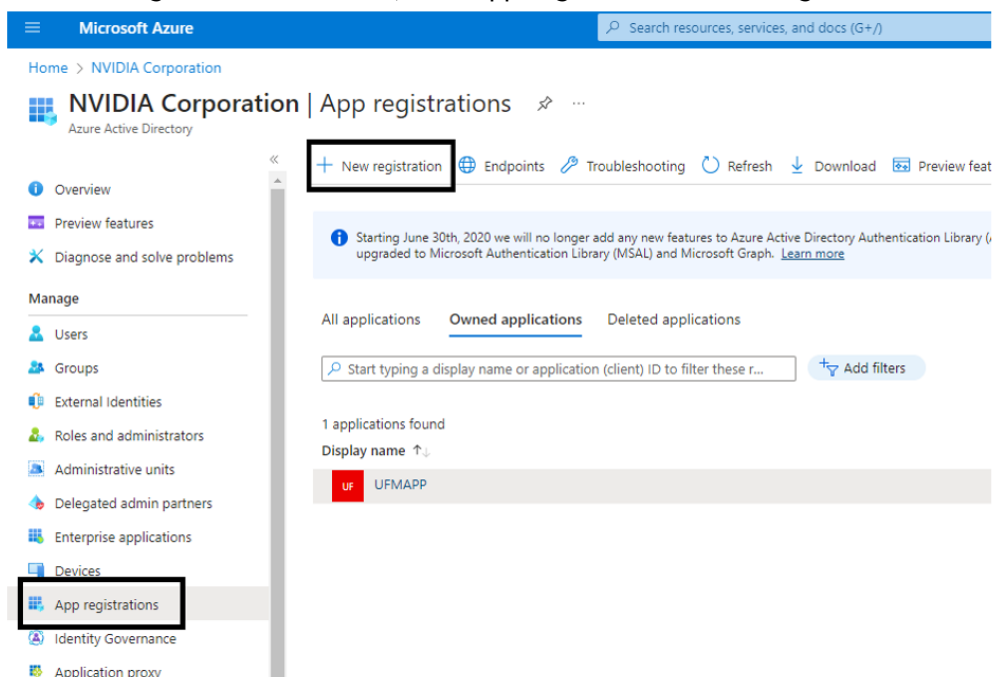

4. Provide the application details:
 - a. Name: Enter a descriptive name.
 - b. Supported account types: Account types that are allowed to login and use the registered application.

- c. Redirect URL: select the app type Web, and Add the following redirect URL `https://<ufm_server>/auth/login`

Home > NVIDIA Corporation | App registrations >

Register an application

* Name

The user-facing display name for this application (this can be changed later).

Supported account types

Who can use this application or access this API?

Accounts in this organizational directory only (NVIDIA Corporation only - Single tenant)

Accounts in any organizational directory (Any Azure AD directory - Multitenant)

Accounts in any organizational directory (Any Azure AD directory - Multitenant) and personal Microsoft accounts (e.g. Skype, Xbox)

Personal Microsoft accounts only

[Help me choose...](#)

Redirect URI (optional)

We'll return the authentication response to this URI after successfully authenticating the user. Providing this now is optional and it can be changed later, but a value is required for most authentication scenarios.

Web

Register an app you're working on here. Integrate gallery apps and other apps from outside your organization by adding from [Enterprise applications](#).

By proceeding, you agree to the [Microsoft Platform Policies](#)

[Register](#)

Then, click Register. The app's Overview page opens.

5. Under Manage in the side menu, click Certificates & Secrets > New client secret.

Add a client secret

Description

Expires

Provide a description for the client secret and set an expiration time, then click "Add."

6. Copy the client secret key value which will be needed to configure the UFM with Azure AD (Please note that the value of the generated secret will be hidden and will not be able to be copied/read after you leave the page.

Under "Manage" in the side menu, click App roles > Create app role.

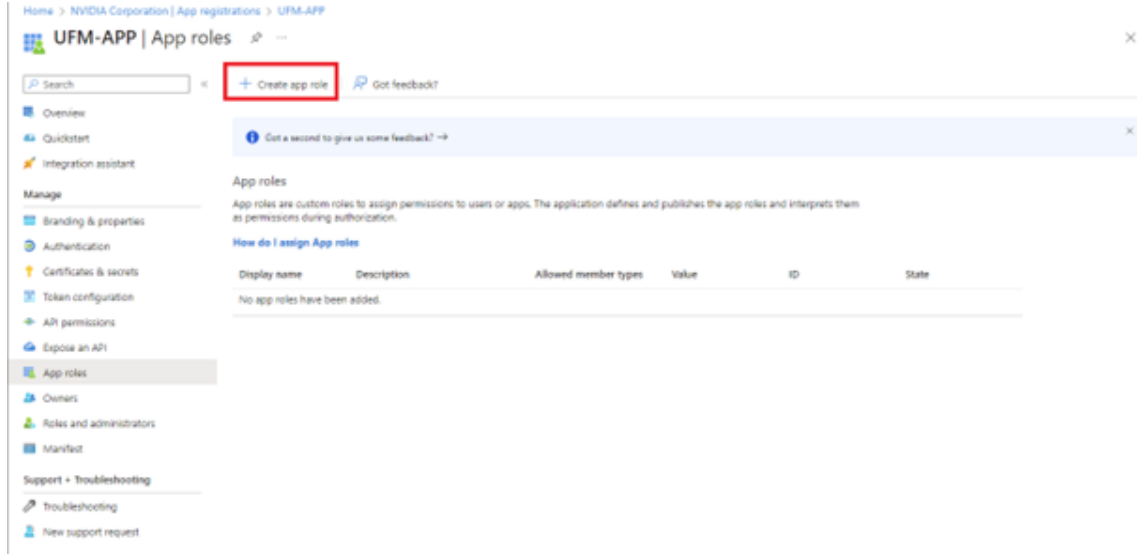

7. Provide the role details. Please note that the role value must be a valid UFM role; otherwise, the login will fail.

The screenshot shows the 'Create app role' form in the Azure portal. The form has a title 'Create app role' and a close button. The fields are as follows:

- Display name ***: A text input field containing 'System_Admin' with a green checkmark on the right.
- Allowed member types ***: A radio button selection with three options: 'Users/Groups', 'Applications', and 'Both (Users/Groups + Applications)'. The 'Both' option is selected.
- Value ***: A text input field containing 'System_Admin' with a green checkmark on the right.
- Description ***: A text input field containing 'System_Admin'.
- Do you want to enable this app role?**: A checkbox that is checked.

8. Assign the created role to the user. Follow the below steps:

Assigning app roles

App roles for Users/Groups

Assign app roles with 'User' allowed member types in **Enterprise** applications or in Microsoft Graph APIs.

[Learn more about how to assign App roles for Users/Groups](#)

App roles for applications

Assign app roles with 'Applications' allowed member types in API permissions blade.

App roles

App roles are custom roles to assign permissions to users or apps. The application defines permissions during authorization.

[How do I assign App roles](#) **1**

Display name	Description	Allowed member ty...	Value
System_Admin	System_Admin	Users/Groups,Applicat...	Syste

Properties

UF Name [Copy to clipboard](#)

Application ID

Object ID

Getting Started **3**

1. Assign users and groups

Provide specific users and groups access to the applications

[Assign users and groups](#)

2. Provision User Accounts

You'll need to create user accounts in the application

[Learn more](#)

3. Self service

Enable users to request access to the application using their Azure AD credentials

[Get started](#)

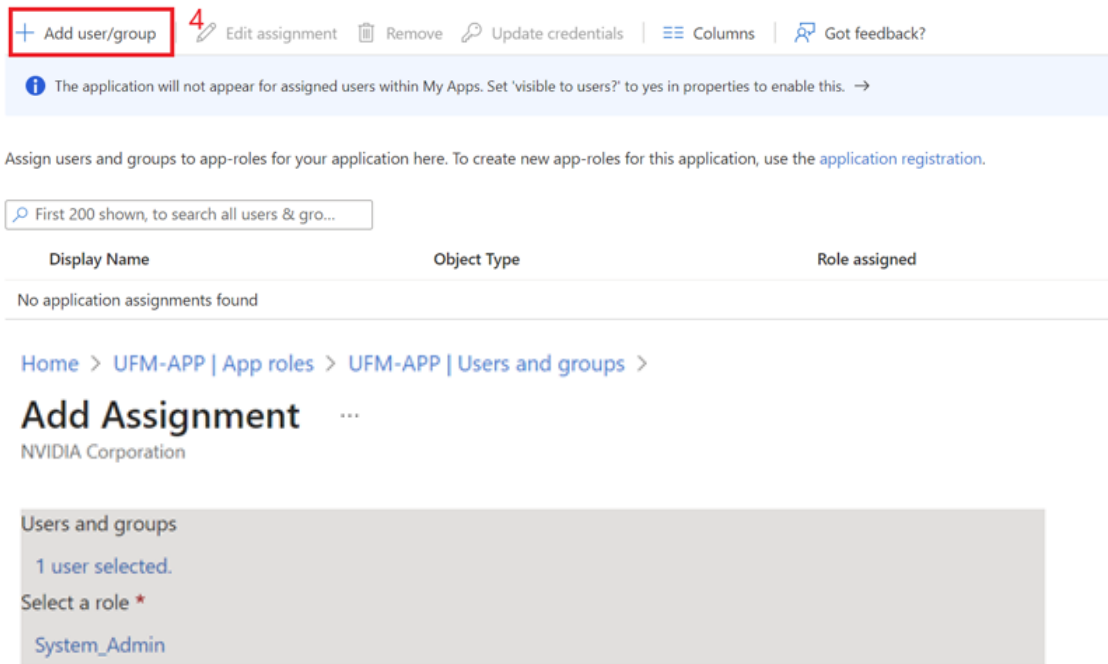

9. Click on "Overview" in the side menu to view the application information, such as tenant ID, client ID, and other details.

3.6.7.2 Enable Azure Authentication From UFM

Azure authentication is disabled by default. To enable it, please refer to [Enabling Azure AD Authentication](#).

3.6.7.3 Azure Authentication Login Page

After enabling and configuring Azure AD authentication, an additional button will appear on the primary UFM login page labeled 'Sign In with Microsoft,' which will lead to the main Microsoft sign-in page:

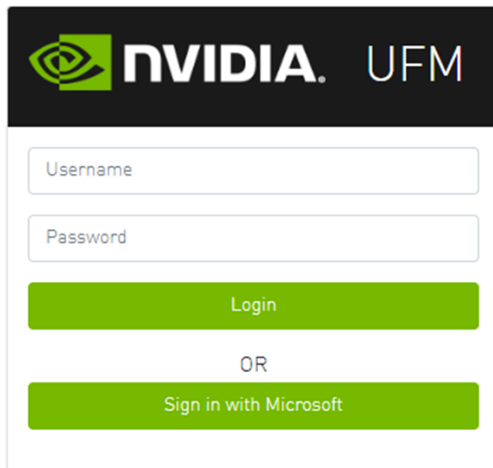

3.6.7.4 Kerberos Authentication

Kerberos is a network authentication protocol designed to provide strong authentication for client-server applications by using secret-key cryptography.

The Kerberos protocol works on the basis of tickets, it helps ensure that communication between various entities in a network is secure. It uses symmetric-key cryptography, which means both the client and servers share secret keys for encrypting and decrypting communication.

To enable Kerberos Authentication, refer to [Enabling Kerberos Authentication](#).

3.6.7.4.1 Setting Up Kerberos Server Machine

To set up a system as a Kerberos server, perform the following:

1. Install the required packages:

```
#Redhat
sudo yum install krb5-libs krb5-server
# Ubuntu
sudo apt-get install krb5-kdc krb5-admin-server
```

2. Edit the Kerberos configuration file ‘`/etc/krb5.conf`’ to reflect your realm, domain and other settings:

```
[libdefaults]
    default_realm = YOUR-REALM

[realms]
    YOUR-REALM = {
        kdc = your-kdc-server
        admin_server = your-admin-server
    }

[domain_realm]
    your-domain = YOUR-REALM
    your-domain = YOUR-REALM
```

3. Use the `kdb5_util` command to create the Kerberos database:

```
kdb5_util create -r YOUR-REALM -s
```

4. Add administrative principals:

```
Kadmin.local addprinc -randkey HTTP/YOUR-HOST-NAME@YOUR-REALM
```

5. Start KDC and Kadmin services:

```
sudo systemctl start krb5kdc kadmin
sudo systemctl enable krb5kdc kadmin
```

6. Generate a keytab file. The keytab file contains the secret key for a principal and is used to authenticate the service.

```
kadmin.local ktadd -k /path/to/your-keytab-file HTTP/YOUR-HOST-NAME@YOUR-REALM
```

Replace `/path/to/your-keytab-file` with the actual path where you want to store the keytab file.

3.6.7.4.2 Setting Up Kerberos Client Machine

Follow the below steps to set up a system as a Kerberos client.

1. Install the required packages. When installing the UFM, the following packages will be installed as dependencies:

```
#Redhat
krb5-libs krb5-workstation mod_auth_gssapi
# Ubuntu
krb5-config krb5-user libapache2-mod-auth-gssapi
```

2. Configure the `/etc/krb5.conf` file to reflect your realm, domain, local names map and other settings:

```
[libdefaults]
    default_realm = YOUR-REALM

[realms]
    YOUR-REALM = {
        kdc = your-kdc-server
        admin_server = your-admin-server
        auth_to_local_names = {
            your-principle-name = your-local-user
        }
    }

[domain_realm]
    your-domain = YOUR-REALM
    your-domain = YOUR-REALM
```

3. Copy the keytab file from the Kerberos server to the machine where your service runs (the client). It is important to ensure that it is kept confidential. Please ensure that the keytab file exists and that Apache has the necessary read permissions to access the keytab file; otherwise, Kerberos authentication will not function properly.
4. Obtain a Kerberos ticket-granting ticket (TGT):

```
kinit -k -t /path/to/your-keytab-file HTTP/YOUR-HOST-NAME@YOUR-REALM
```

5. Enable Kerberos Authentication from UFM. Kerberos authentication is disabled by default. To enable it, please refer to [Enabling Kerberos Authentication](#).
6. Test the Kerberos Authentication. You can use curl to test whether the user can authenticate to UFM REST APIs using Kerberos.

```
curl --negotiate -i -u : -k 'https://ufmc-eos01/ufmRestKrb/app/tokens'
```

3.6.8 Licensing

UFM license is subscription-based featuring the following subscription options:

- 1-year subscription
- 3-year subscription
- 5-year subscription
- Evaluation 30-day trial license

UFM will continue to support old license types, but they are no longer available to obtain.

2 months before the expiration of your subscription license, UFM will warn you that your license will expire soon. After the subscription expires, UFM will continue to work with the expired license for two months beyond its expiration.

During this extra two-month period, UFM will generate a critical alarm indicating that the UFM license has expired and that you need to renew your subscription. Failing to do so within that 2-month period activates UFM Limited Mode. Limited mode blocks all REST APIs and access to the UFM web UI.

UFM enables functionality based on the license that was purchased and installed. This license determines the functionality and the maximum allowed number of nodes in the fabric.

To renew your UFM subscription, purchase a new license and install the new license file by downloading the license file to a temp directory on the UFM master server and then copying the license file to `/opt/ufm/files/licenses/` directory.

UFM may not detect new license files if downloaded directly to `/opt/ufm/files/licenses`. If UFM does not detect the new license file, a UFM restart may be required.

If several licenses are installed on the server (more than one license file exists under `/opt/ufm/files/licenses/`), UFM uses only the strongest license and takes into consideration the expiration date, and the managed device limits on it, regardless of any other licenses that may exist on the server.

3.6.9 Showing UFM Processes Status

This functionality allows users to view the current status of main processes handled by the UFM.

- To view the main UFM processes, run the script `show_ufm_status.sh` under the `/opt/ufm/scripts` .

Example: `/opt/ufm/scripts/show_ufm_status.sh`

- To view the UFM main and child processes, run the script `show_ufm_status.sh` with `-e` (extended_processes).
Example: `/opt/ufm/scripts/show_ufm_status.sh -e`

```
[root@r-ufm77 gvm_github]# /opt/ufm/scripts/show_ufm_status.sh
=====
                        UFM Main Processes
=====
ModelMain      Process is : [ Running ]
Opensm         Process is : [ Running ]
SHARP          Process is : [ Running ]
Unhealthy Ports Process is : [ Running ]
Daily Report   Process is : [ Running ]
UFM Health     Process is : [ Running ]
UFM Telemetry  Process is : [ Running ]

-----

[root@r-ufm77 gvm_github]# /opt/ufm/scripts/show_ufm_status.sh -e
=====
                        UFM Main Processes
=====
ModelMain      Process is : [ Running ]
Opensm         Process is : [ Running ]
SHARP          Process is : [ Running ]
Unhealthy Ports Process is : [ Running ]
Daily Report   Process is : [ Running ]
UFM Health     Process is : [ Running ]
UFM Telemetry  Process is : [ Running ]

-----

                        UFM ModelMain Child Processes
=====
SMClientConsumer Process is : [ Running ]
SMTrapHandler    Process is : [ Running ]
SysinfoJsonAgent Process is : [ Running ]
Telemetry Agent  Process is : [ Running ]
Telemetry History Process is : [ Running ]
```

3.7 Upgrading UFM Software

After UFM installation, UFM detects existing UFM versions previously installed on the machine and prompts you to run a clean install of the new version or to upgrade. We recommend backing up the UFM configuration before upgrading the UFM as specified in the section UFM Database and Configuration File Backup.

Upgrading the UFM Enterprise software version is supported up to two previous GA software versions (GA -1 or GA -2).
For example, if you wish to upgrade to UFM Enterprise v6.11.0, it is possible to do so only from UFM Enterprise v6.9.0 or v6.10.0.

- [Upgrading UFM on Bare Metal Server](#)
- [Upgrading UFM on Docker Container](#)

3.7.1 Upgrading UFM on Bare Metal Server

3.7.1.1 Upgrading UFM on Bare Metal - Standalone Server Upgrade

You can upgrade the UFM standalone server software for InfiniBand from the previous UFM version.

To upgrade the UFM server software:

1. Create a temporary directory (for example `/tmp/ufm`).

2. Open the UFM software zip file that you downloaded. The zip file contains the following installation files for:
 - RedHat 7/CentOS 7/OEL 7: ufm-X.X -XXX.el7.x86_64.tgz
 - RedHat 8/CentOS 8/OEL 8: ufm-X.X -XXX.el8.x86_64.tgz
 - Ubuntu 18.04: ufm-X.X -XXX.ubuntu18.x86_64.tgz
 - Ubuntu 20.04: ufm-X.X -XXX.ubuntu20.x86_64.tgz
 - Ubuntu 22.04: ufm-X.X -XXX.ubuntu22.x86_64.tgz
3. Extract the installation file for your system's OS to the temporary directory that you created.
4. Stop the UFM server. Run:

```
systemctl stop ufm-enterprise
```

5. From within the temporary directory, run the following command as root:

```
./upgrade.sh
```

A configuration backup ZIP file will be created in the running directory (e.g. /tmp/ufm). The backup file name is ufm_X.X.X_bkp.zip (X.X.X is the previous version).

- a. Upgrade from the previous version: the existing UFM data and configuration are preserved.
 - b. In case upgrade.sh script stops before completion (e.g. missing prerequisite), the upgrade procedure can be resumed by fixing the issue (e.g. installing missing prerequisite) and rerunning ./upgrade.sh again.
6. Restart the UFM server. Run:

```
systemctl start ufm-enterprise.service
```

/etc/init.d/ufmd start - Available for backward compatibility.

7. After the upgrade, remove the temporary directory

3.7.1.2 Upgrading UFM on Bare Metal - High Availability Upgrade

As of UFM version 6.14.0, UFM upgrade on HA supports in-service upgrade, meaning UFM can continue running during the steps of the upgrade, and there is no need to stop UFM before the upgrade (although this is also supported).

You can upgrade the UFM server HA software for InfiniBand from the previous release. The upgrade is performed on both servers.

To upgrade the UFM server software:

Upgrading the UFM Enterprise Package

1. On the standby server, extract the new UFM Enterprise package to the /tmp folder:

```
tar -xzf ufm-X.X.X-XXXXX.tgz -C /tmp
```

2. On the standby server, enter to the installation folder and upgrade script:

```
standby# cd /tmp/ ufm-X.X.X-X.<OS_NAME>.x86_64.mofed5/
```

3. Run the UFM upgrade script on the standby server:

```
./upgrade.sh
```

4. After the completion of the upgrade script, the UFM code will undergo an upgrade, while the UFM data will remain unchanged. The automatic upgrade of UFM data will take place during the next startup of UFM. To initiate this process, execute a failover from the Master node (or perform a takeover from the Standby node).

```
master# ufm_ha_cluster failover
```

UFM will log the data upgrade to the syslog of the server, in case of issue a backup of the UFM data is saved prior to the upgrade in /opt/ufm/BACKUP directory and can be restored. For more information, refer to [Appendix - Restoring UFM Data](#).

5. Once UFM is operational on the upgraded node (formerly the standby node), proceed to replicate steps 1 to 3 on the non-upgraded node (previously the master node).

Upgrading the UFM HA Package

1. On both servers, download latest UFM-HA package:
Unable to render include or excerpt-include. Could not retrieve page.
2. On both servers, extract the HA package under /tmp/ and enter the new directory
3. Stop the UFM HA cluster, run the following command on the Master server:

```
ufm_ha_cluster stop
```

4. On the UFM Standby server, run the upgrade command from within the extracted HA package located in /tmp :

```
./install.sh --upgrade
```

5. On the UFM Master server, run the upgrade command from within the extracted HA package located in /tmp :

```
./install.sh --upgrade
```

6. Start the UFM HA cluster, run the following command on the Master server:

```
ufm_ha_cluster start
```

7. Run the following command to verify that the UFM HA cluster is up and running:

```
ufm_ha_cluster status
```

3.7.2 Upgrading UFM on Docker Container

Upgrade the UFM container based on the existing UFM configuration files that are mounted on the server. It is important to use that same directory as a volume for the UFM installation command.

In the below example /opt/ufm_files is used.

3.7.2.1 Upgrading UFM on Docker Container in Standalone Mode

1. Stop the UFM Enterprise service. Run:

```
systemctl stop ufm-enterprise
```

2. Remove the existing docker image. Run:

```
docker rmi mellanox/ufm-enterprise:latest
```

3. Load the new UFM Enterprise docker image. Run:

```
docker pull mellanox/ufm-enterprise:latest
```

4. Run the docker upgrade command:

```
docker run -it --name=ufm_installer --rm \
-v /var/run/docker.sock:/var/run/docker.sock \
-v /etc/systemd/system:/etc/systemd_files/ \
-v /opt/ufm/files:/opt/ufm/shared_config_files/ \
mellanox/ufm-enterprise:latest --upgrade
```

5. Reload system manager configuration:

```
systemctl daemon-reload
```

6. Start UFM Enterprise service:

```
systemctl start ufm-enterprise
```

3.7.2.2 Upgrading UFM Container in High Availability Mode

As of UFM version 6.14.0, UFM upgrade on HA supports in-service upgrade, meaning UFM can continue running during the steps of the upgrade, and there is no need to stop UFM before the upgrade (although this is also supported).

Upgrading the UFM Enterprise Package

1. Remove the old docker image from the Standby server. Run:

```
Stand-by# docker rmi mellanox/ufm-enterprise:latest
```

2. Pull the new UFM Enterprise docker image on the Standby server. Run:

```
docker pull mellanox/ufm-enterprise:latest
```

At this stage, the UFM container has been updated with the latest code. The UFM data, however, will be updated during the next UFM run.

3. Perform a failover to start UFM on the upgraded node. On the Master node, run:

```
ufm_ha_cluster failover
```

When UFM starts, it will automatically update the UFM configuration.

4. Repeat steps 1-2 on the un-upgraded node (previous Master node).

Upgrading the UFM HA Package

1. On both servers, download and extract the latest UFM HA package. Run:
Unable to render include or excerpt-include. Could not retrieve page.
2. Stop the UFM HA cluster, run the following command on the Master server:

```
ufm_ha_cluster stop
```

3. On both the Master and Standby servers, execute the upgrade command from within the extracted HA package. Ensure you run it first on the Standby server, then on the Master server:

```
./install.sh --upgrade
```

4. Start the UFM HA cluster by running this command on the Master server:

```
ufm_ha_cluster start
```

5. Run the following command to verify that the UFM HA cluster is up and running:

```
ufm_ha_cluster status
```

3.8 Uninstalling UFM

The UFM Server can be uninstalled by running an uninstall script in the different server modes:

- [Uninstalling UFM in Standalone Mode](#)
- [Uninstalling UFM in High Availability](#)
- [Uninstalling UFM in Docker Deployment](#)

3.8.1 Uninstalling UFM in Standalone Mode

To uninstall the UFM Server:

1. Go to /opt/ufm.
2. Run ./uninstall.sh.

Child interfaces are not deleted.

3. To delete primary interfaces, restart `/etc/init.d/openibd`.

3.8.2 Uninstalling UFM in High Availability

To uninstall the UFM Server in high availability mode:

1. Run the following on the master and slave to clean up the UFM HA configuration:

```
ufm_ha_cluser cleanup
```

2. To uninstall the UFM HA configuration, run:

```
/opt/ufm/ufm_ha/uninstall_ha.sh
```

3. To uninstall UFM Enterprise software, run the following on the master and slave:

```
/opt/ufm/uninstall.sh
```

3.8.3 Uninstalling UFM in Docker Deployment

To uninstall the UFM Server in high availability mode:

1. Run the following on the master and slave:

```
ufm_ha_cluser cleanup
```

2. Run:

```
/opt/ufm/ufm_ha/uninstall_ha.sh
```

3. Run the following on the master and slave:

```
/opt/ufm/files/uninstall.sh
```

3.9 UFM Configuration Backup and Restore

3.9.1 Overview

UFM migration enables backup and restores UFM configuration files.

3.9.2 Backup UFM configuration

By default, the following folders (placed in `/opt/ufm/files`) are being backed up:

- `conf`
- `dashboardViews`

- licenses
- networkViews
- scripts
- sqlite
- templates/user-defined
- ufmhealth/scripts
- userdata
- users_preferences

The user may also backup the UFM historical telemetry data ("-t" argument).

3.9.2.1 UFM (Bare Metal)

```
/opt/ufm/scripts/ufm_backup.sh --help
usage: ufm_backup.pyc [-h] [-f BACKUP_FILE] [-t]
```

3.9.2.1.1 Optional Arguments

-h	--help	show this help message and exit
-f	--backup-file BACKUP_FILE	full path of zip file to be generated
-t	--telemetry	backup UFM historical telemetry

3.9.2.2 UFM Docker Container

1. Backup UFM configuration. Run:

```
docker exec ufm /opt/ufm/scripts/ufm_backup.sh
```

2. Copy the backup file from UFM docker container to the host. Run:

```
docker cp ufm:/root/<backup file> <path on host>
```

3.9.2.3 UFM Appliance

1. Backup UFM configuration. Run:

```
ufm data backup [with-telemetry]
```

2. Upload the backup file to a remote host. Run:

```
ufm data upload <backup file> <upload URL>
```

More details can be found in the log file `/tmp/ufm_backup.log`.

3.9.3 Restore UFM Configuration

All folders which are a part of the UFM backup are restored (filter is done during the backup stage).

3.9.3.1 UFM Bare Metal

```
/opt/ufm/scripts/ufm_restore.sh --help
usage: ufm_restore.py [-h] -f BACKUP_FILE [-u] [-v]
```

3.9.3.1.1 Optional Arguments

-h	--help	show this help message and exit
-f BACKUP_FILE	--backup-file BACKUP_FILE	full path of zip file generated by backup script
-u	--upgrade	upgrades the restored UFM files
-v	--verbose	makes the operation more talkative

3.9.3.2 UFM Docker Container

1. Stop UFM. Run:

```
docker exec ufm /etc/init.d/ufmd stop
```

2. Copy the backup file from the host into UFM docker container. Run:

```
docker cp <backup file> ufm:/tmp/<backup file>
```

3. Restore UFM configuration. Run:

```
docker exec ufm /opt/ufm/scripts/ufm_restore.sh -f /tmp/<backup file> [--upgrade]
```

4. Start UFM. Run:

```
docker exec ufm /etc/init.d/ufmd start
```

3.9.3.3 UFM Appliance

1. Stop UFM. Run:

```
no ufm start
```

2. Copy the backup file from a remote host into UFM appliance. Run:

```
ufm data fetch <download URL>
```

3. Restore UFM configuration. Run:

```
ufm data restore <backup file>
```

4. Start UFM. Run:

```
ufm start
```

When restoring the UFM configuration from host to a container, the following parameters in `/opt/ufm/files/conf/gv.cfg` may be reset the following:

- fabric_interface
- ufma_interfaces
- mgmt_interface

UFM configuration upgrade during restore is not supported in UFM Appliance GEN2/GEN2.5

More details can be found in the log files `/tmp/ufm_restore.log` and `/tmp/ufm_restore_upgrade.log`

3.10 UFM Factory Reset

This section provides a comprehensive guide on resetting UFM to its original factory settings.

WARNING!!! this operation will remove all user data and configuration and will restore UFM to its factory defaults.

The UFM Factory-Reset will exclusively revert UFM to its original factory settings, leaving HA configurations unaffected. To remove HA, it is essential to execute `ufm_ha_cluster cleanup` before initiating the factory reset.

3.10.1 UFM Docker Container Factory Reset

To reset UFM to its factory defaults when using UFM on a Docker container, follow these steps.

1. Ensure that UFM is not up and running. If UFM is running, stop it.
For Stand-alone (SA) installations:

```
systemctl stop ufm-enterprise
# validate that ufm is not running
systemctl status ufm-enterprise
```

For High-Availability setups (perform the following on the master node only):

```
ufm_ha_cluster stop
# validate that ufm is not running
ufm_ha_cluster status
```

2. Run `mellanox/ufm-enterprise` Docker Container with the following flags:

WARNING: This operation will erase all user data and configurations, resetting UFM to its factory defaults.

CAUTION: This step does not require user confirmation, meaning UFM will be restored to factory defaults immediately once initiated.

```
docker run -it --name=ufm_installer --rm \
-v /var/run/docker.sock:/var/run/docker.sock \
-v /tmp:/tmp \
-v /opt/ufm/files:/opt/ufm/shared_config_files/ \
mellanox/ufm-enterprise:latest \
--factory-reset
```

Flag	Type	Description
<code>--name=ufm_installer</code>	Mandatory	The container name must be called <code>ufm_installer</code> .
<code>-v /var/run/docker.sock:/var/run/docker.sock</code>	Mandatory	The docker socket must be mounted on the docker container.
<code>-v /tmp:/tmp</code>	Optional	Logs of the operation can be viewed in <code>/tmp</code> on the host in case it is mounted.
<code>-v /opt/ufm/files:/opt/ufm/shared_config_ufm/</code>	Mandatory	For the factory reset to persist, it is essential to have the <code>/opt/ufm/files</code> directory mounted from the host.
<code>mellanox/ufm-enterprise:latest</code>	Mandatory	The docker image name.
<code>--factory-reset</code>	Mandatory	This action will signal the UFM container to initiate the factory reset process.

3.10.2 UFM Enterprise Factory Reset

To restore UFM Enterprise to factory defaults:

1. Ensure that UFM is not up and running. If UFM is running, stop it.

For Stand-alone (SA) installations:

```
systemctl stop ufm-enterprise
# validate that ufm is not running
systemctl status ufm-enterprise
```

For High-Availability setups (perform the following on the master node only):

```
ufm_ha_cluster stop
# validate that ufm is not running
ufm_ha_cluster status
```

2. Run the `ufm_factory_reset.sh` script:

WARNING: This operation will erase all user data and configurations, resetting UFM to its factory defaults.

```
/opt/ufm/scripts/ufm_factory_reset.sh [-y]
```

Flag:

Flag	Type	Description
-y	Optional	Does not require user confirmation.

4 Manage Users

4.1 Accounts and Roles

Each UFM user can be assigned to one of the following four roles:

- System Admin - users can perform all operations including managing other users accounts.
- Fabric Admin - users can perform fabric administrator actions such as update SM configuration, update global credentials, manage reports, managing unhealthy ports, and manage PKeys, etc.
- Fabric Operator - users can perform fabric operator actions such as device management actions (enable/disable port, add/remove devices to/from groups, reboot device, upgrade software, etc.)
- Monitoring Only - users can perform monitoring actions such as view the fabric configuration, open monitoring sessions, define monitoring templates, and export monitoring data to CSV files, etc.

4.2 User Account Management

By default and upon every UFM deployment, the admin user (System Admin) is generated to allow initial access to the UFM.

A user with system Administration rights can manage other users' accounts, including the creation, deletion, and modification of accounts.

To edit existing user accounts, right-click the account from the list of user accounts and perform the desired action (Change Password/Remove).

4.2.1 Add New User

1. Click the “New” button.

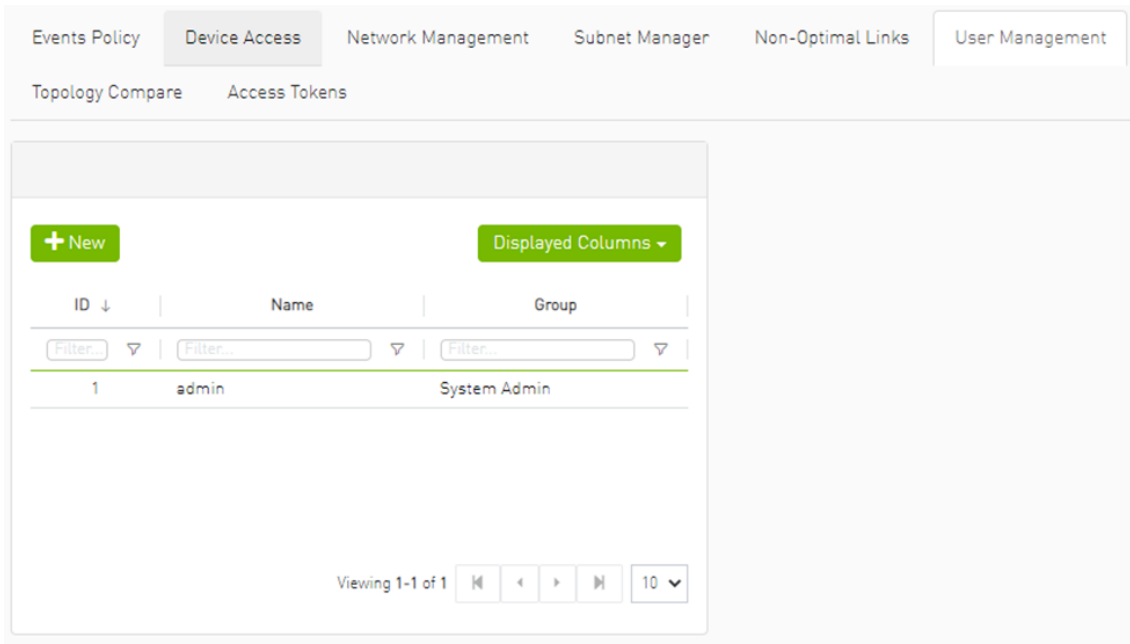

The screenshot shows the 'User Management' tab in a software interface. At the top, there are navigation tabs: 'Events Policy', 'Device Access', 'Network Management', 'Subnet Manager', 'Non-Optimal Links', and 'User Management'. Below these are 'Topology Compare' and 'Access Tokens'. The main content area features a '+ New' button and a 'Displayed Columns' dropdown. A table with columns 'ID', 'Name', and 'Group' contains one entry: ID 1, Name 'admin', and Group 'System Admin'. Each column has a 'Filter...' input. At the bottom, it says 'Viewing 1-1 of 1' with navigation icons and a page size dropdown set to 10.

2. Fill in the required fields in the dialog box.

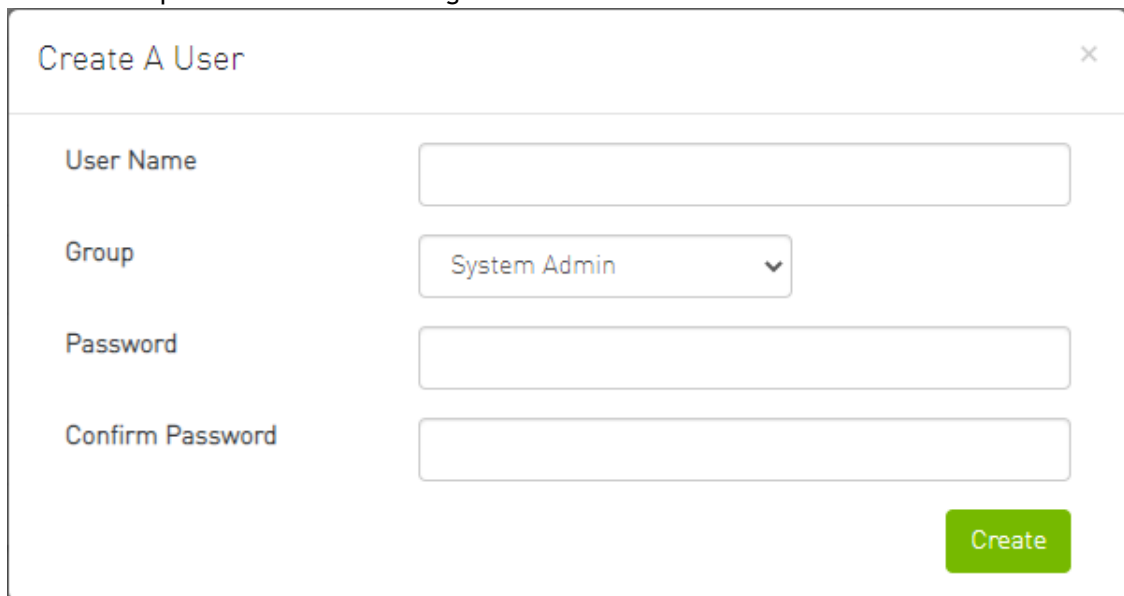

The 'Create A User' dialog box contains the following fields:

- User Name:
- Group:
- Password:
- Confirm Password:

A green 'Create' button is located at the bottom right of the dialog.

4.2.2 Edit/Remove Existing User

Right-click the account from the list of user accounts and perform the desired action (Change Password/Remove).

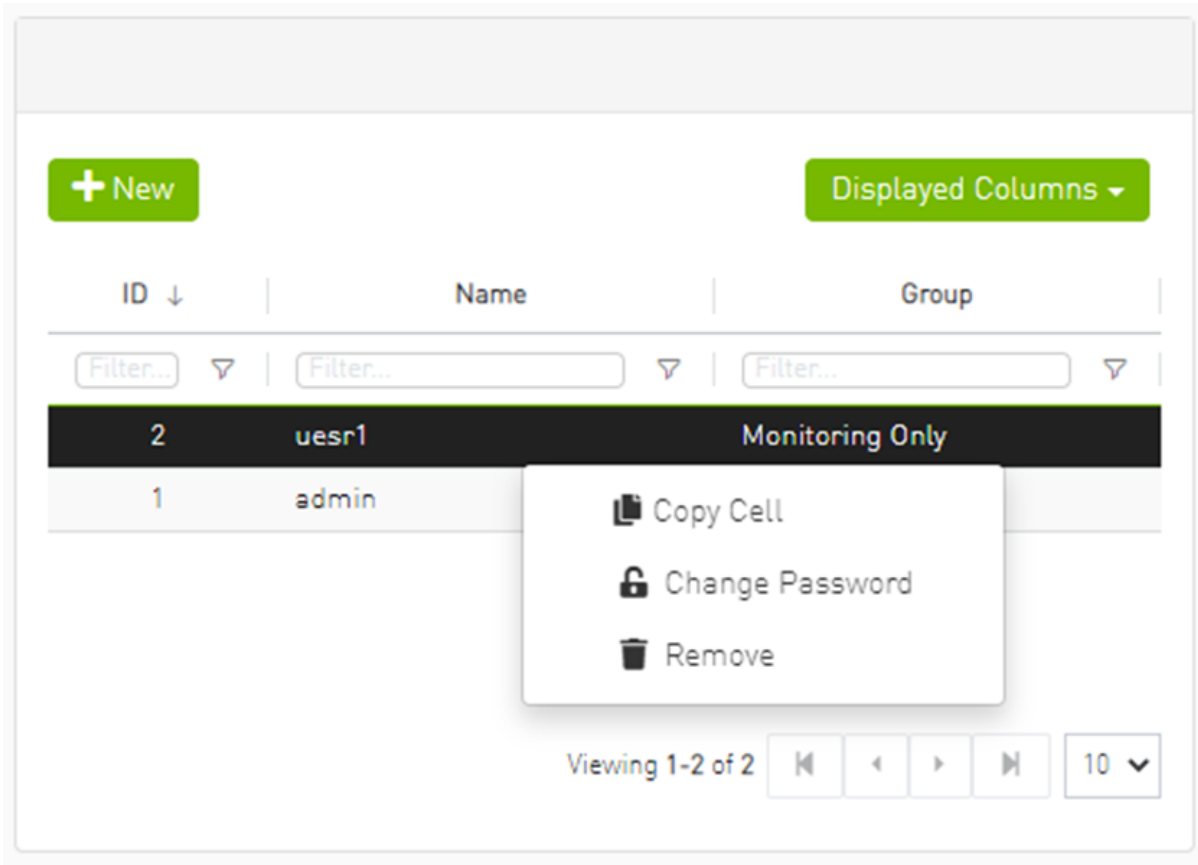

4.3 Authentication Methods

- [4.3.1 UFM Authentication Server](#)
 - [4.3.1.1 Configurations of the UFM Authentication Server](#)
- [4.3.2 Token-Based Authentication](#)
- [4.3.3 Proxy Authentication](#)
 - [4.3.3.1 Delegating Authentication to a Proxy](#)
- [4.3.4 Azure AD Authentication](#)
 - [4.3.4.1 Register UFM in Azure AD Portal](#)
 - [4.3.4.2 Enable Azure Authentication From UFM](#)
 - [4.3.4.3 Azure Authentication Login Page](#)
- [4.3.5 Kerberos Authentication](#)
 - [4.3.5.1 Setting Up Kerberos Server Machine](#)
 - [4.3.5.2 Setting Up Kerberos Client Machine](#)

UFM User Authentication is based on standard Apache User Authentication or Internal UFM Authentication Server.

Each Web Service client application must authenticate against the UFM server to gain access to the system.

The available authentication methods supported by UFM are as follows:

Authentication Method	Description	UFM Related Prefix	REST API Reference
Basic Authentication	Based on user and password, provided by the client. This method is enabled by default.	/ufmRest	Basic Authentication
Session-Based Authentication	A stateful authentication technique where sessions are used to keep track of the authenticated user. This method is enabled by default and is used by the UFM WebUI.	/ufmRestV2	Session-Based Authentication
Client-Based Authentication	Refers to an end user's device proving its own identity by providing a digital certificate that can be verified by a server in order to gain access to UFM resources	/ufmRest	Client-Based Authentication
Token-Based Authentication	Token-based authentication is a protocol which allows users to verify their identity, and in return receive a unique access token. To use UFM, the user should create a token using UFM Web UI or UFM REST API	/ufmRestV3	Token-Based Authentication
Proxy Authentication	Proxy authentication delegates the user authentication to a remote Proxy server.	/ufmRestV2 or /ufmRestV3	N/A
Azure AD Authentication	Microsoft Azure Authentication is a service provided by Microsoft Azure, the cloud computing platform of Microsoft. It is designed to provide secure access control and authentication for applications and services hosted on Azure.	/ufmRestV2	N/A
Kerberos Authentication	Kerberos is a protocol designed to authenticate service requests between trusted hosts over an untrusted network	/ufmRestKrb	N/A

There are two optional services which can provide authentication handling of UFM.

1. Apache Web Server (used by default) - Standard Apache web server and supports the above-mentioned authentication methods.
2. UFM Authentication Server - a centralized HTTP server, is responsible for managing various authentication methods supported by UFM.

4.3.1 UFM Authentication Server

4.3.1.1 Configurations of the UFM Authentication Server

The UFM Authentication Server is designed to be configurable and is initially turned on by default.

Enabling the UFM Authentication Server provides a centralized service that oversees all supported authentication methods within a single service, consolidating them under a unified authentication API.

Apache utilizes the authentication server's APIs to determine a user's authentication status.

All activities of the UFM Authentication Server are logged in the `authentication_service.log` file, located at `/opt/ufm/files/log`.

To enable/disable the UFM Authentication Server, refer to [Enabling UFM Authentication Server](#).

4.3.2 Token-Based Authentication



Token-based authentication is a protocol which allows users to verify their identity, and in return receive a unique access token. During the life of the token, users then access the UFM APIs that the token has been issued for, rather than having to re-enter credentials each time they need to use any UFM API.

Under the Settings section there is a tab titled called "Access Tokens".

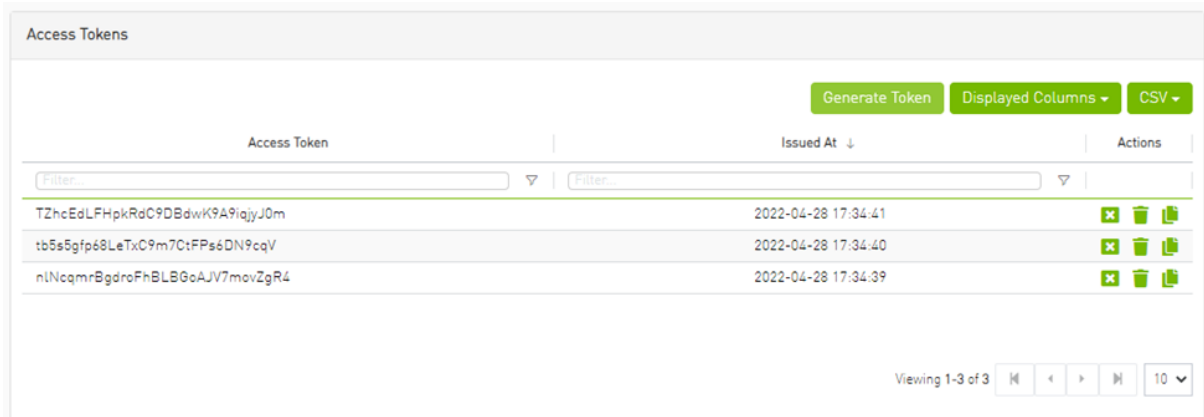
The functionality of the added tab is to give the user the ability to create new tokens & manage the existing ones (list, copy, revoke, delete):



Actions:

Name	Icon	Description
Revoke		Revoke a specific token. <div style="border: 1px solid #ccc; padding: 5px; margin-top: 5px;">The revoked token will no longer be valid.</div>
Delete		Delete a specific token.
Copy		Copy specific token into the clipboard.

Each user is able to list and manage only the tokens that have been created by themselves. Only the users with `system_admin` role will be able to create tokens.

4.3.3 Proxy Authentication

4.3.3.1 Delegating Authentication to a Proxy

To allow a custom user authentication, you can configure UFM to delegate the user authentication to a remote Proxy server. The remote Proxy server is written by the user, thus, allowing flexibility on deciding how the authentication is performed.

By default, the feature is disabled. To activate the feature, configure `auth_proxy_enabled` with `true`.

In case server authentication is enabled, use `/ufmRestV2`, otherwise, use `/ufmRestV3` to send requests to UFM.

The request header should contain a username and role. The available roles are `System_Admin`, `Fabric_Admin`, `Fabric_Operator`, and `Monitoring_Only`. If the request header is sent without a username or a role, it is rejected by the UFM.

For example:

```
[AuthProxy]
# Defaults to false, but set to true to enable this feature
auth_proxy_enabled = true
# HTTP Header name that will contain the username
auth_proxy_header_name = X_WEBAUTH_USER
# HTTP Header name that will contain the user roles. The available roles are as follows: System_Admin,
Fabric_Admin, Fabric_Operator, and Monitoring_Only
auth_proxy_header_role = X_WEBAUTH_ROLE

# Set to `true` to enable auto sign up of users who do not exist in UFM DB. Defaults to `true`.
auth_proxy_auto_sign_up = true
# Limit where auth proxy requests come from by configuring a list of IP addresses.
# This can be used to prevent users spoofing the X_WEBAUTH_USER header.
# This option is required
# Example `whitelist = 192.168.1.1, 192.168.1.0/24, 2001::23, 2001::0/120`
auth_proxy_whitelist =
```

4.3.4 Azure AD Authentication

Microsoft Azure Authentication is a service provided by Microsoft Azure, the cloud computing platform of Microsoft. It is designed to provide secure access control and authentication for applications and services hosted on Azure.

UFM supports Authentication using Azure Active Directory, and to do so, you need to follow the following steps:

4.3.4.1 Register UFM in Azure AD Portal

To log in via Azure, UFM must be registered in the Azure portal using the following steps:

1. Log in to [Azure Portal](#), then click "Azure Active Directory" in the side menu.

2. If you have access to more than one tenant, select your account in the upper right. Set your session to the Azure AD tenant you wish to use.
3. Under "Manage" in the side menu, click App Registrations > New Registration.

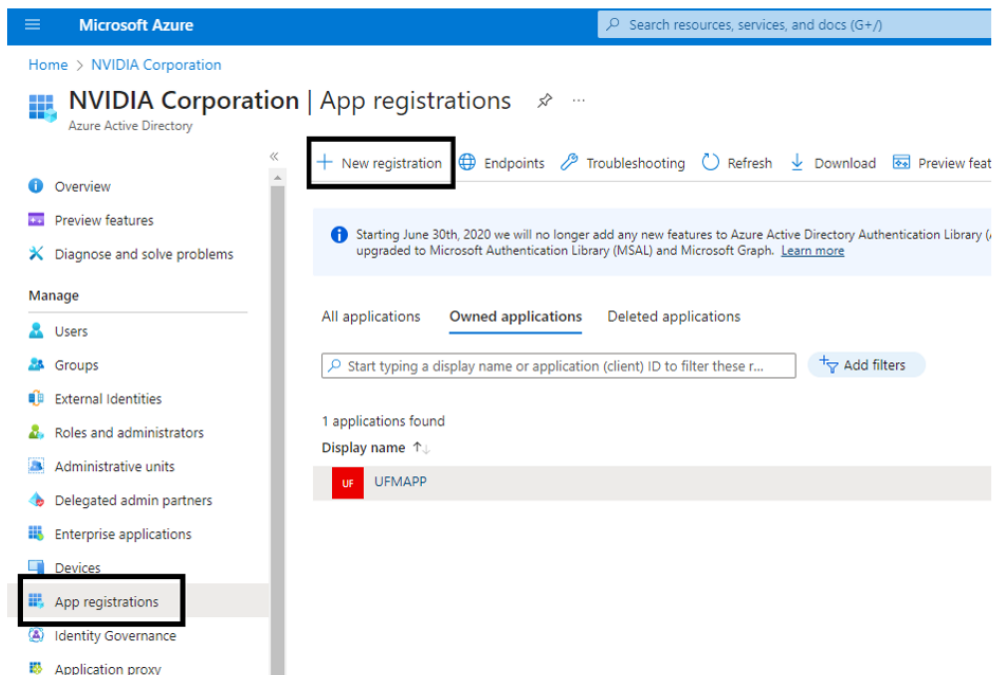

4. Provide the application details:
 - a. Name: Enter a descriptive name.
 - b. Supported account types: Account types that are allowed to login and use the registered application.

- c. Redirect URL: select the app type Web, and Add the following redirect URL `https://<ufm_server>/auth/login`

Home > NVIDIA Corporation | App registrations >

Register an application

*** Name**
The user-facing display name for this application (this can be changed later).

UFM_APP ✓

Supported account types
Who can use this application or access this API?

Accounts in this organizational directory only (NVIDIA Corporation only - Single tenant)

Accounts in any organizational directory (Any Azure AD directory - Multitenant)

Accounts in any organizational directory (Any Azure AD directory - Multitenant) and personal Microsoft accounts (e.g. Skype, Xbox)

Personal Microsoft accounts only

[Help me choose...](#)

Redirect URI (optional)
We'll return the authentication response to this URI after successfully authenticating the user. Providing this now is optional and it can be changed later, but a value is required for most authentication scenarios.

Web ✓ `https://10.209.36.68/auth/login` ✓

Register an app you're working on here. Integrate gallery apps and other apps from outside your organization by adding from [Enterprise applications](#).

By proceeding, you agree to the [Microsoft Platform Policies](#)

Register

Then, click Register. The app's Overview page opens.

5. Under Manage in the side menu, click Certificates & Secrets > New client secret.

Add a client secret

Description

Expires

Provide a description for the client secret and set an expiration time, then click "Add."

6. Copy the client secret key value which will be needed to configure the UFM with Azure AD (Please note that the value of the generated secret will be hidden and will not be able to be copied/read after you leave the page.)

Under "Manage" in the side menu, click App roles > Create app role.

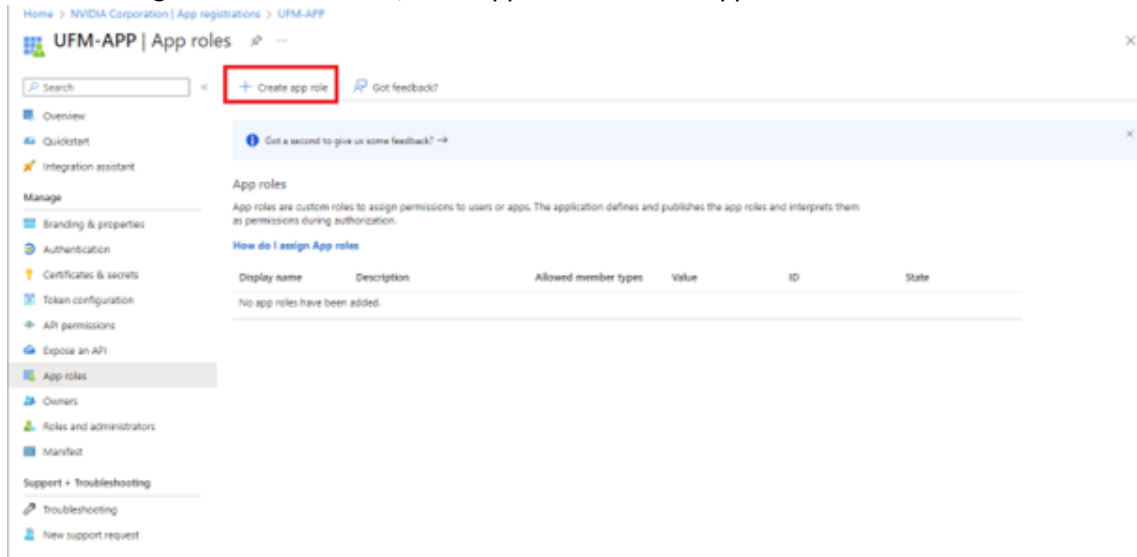

7. Provide the role details. Please note that the role value must be a valid UFM role; otherwise, the login will fail.

The 'Create app role' form is shown with the following fields and values:

- Display name * ⓘ: System_Admin ✓
- Allowed member types * ⓘ: Both (Users/Groups + Applications)
- Value * ⓘ: System_Admin ✓
- Description * ⓘ: System_Admin
- Do you want to enable this app role? ⓘ:

8. Assign the created role to the user. Follow the below steps:

Assigning app roles

App roles for Users/Groups

Assign app roles with 'User' allowed member types in **Enterprise** applications or in Microsoft Graph APIs.

[Learn more about how to assign App roles for Users/Groups](#)

App roles for applications

Assign app roles with 'Applications' allowed member types in API permissions blade.

App roles

App roles are custom roles to assign permissions to users or apps. The application determines the permissions during authorization.

[How do I assign App roles](#) **1**

Display name	Description	Allowed member ty...	Value
System_Admin	System_Admin	Users/Groups,Applicat...	Syste

Properties

UF Name [Copy to clipboard](#)

Application ID

Object ID

Getting Started **3**

1. Assign users and groups

Provide specific users and groups access to the applications

[Assign users and groups](#)

2. Provision User Accounts

You'll need to create user accounts in the application

[Learn more](#)

3. Self service

Enable users to request access to the application using their Azure AD credentials

[Get started](#)

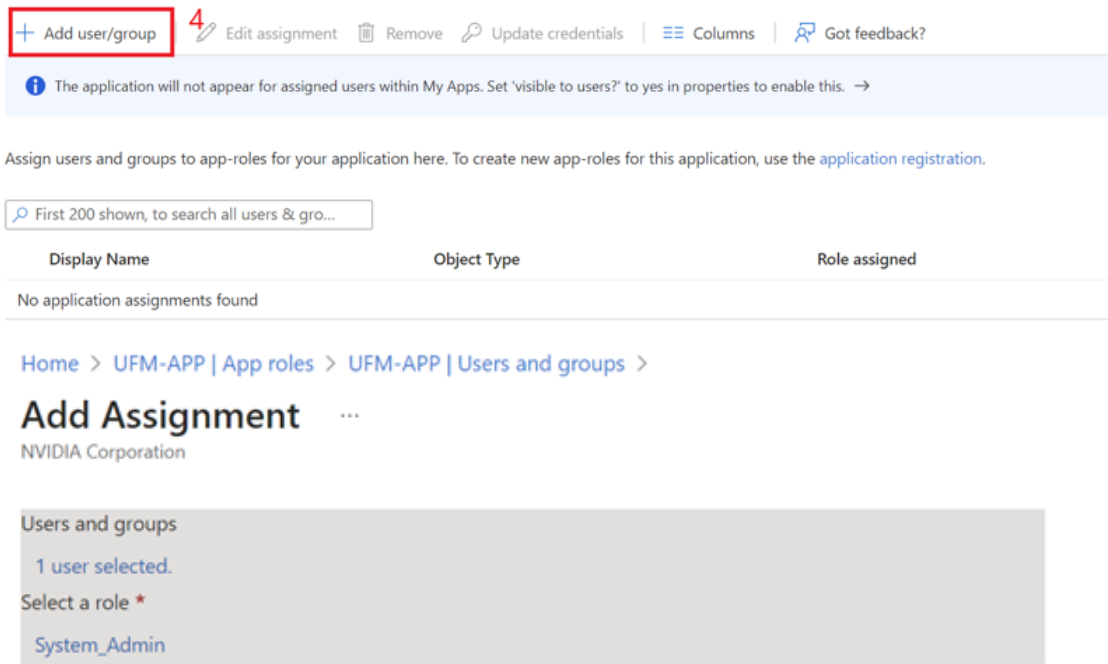

9. Click on "Overview" in the side menu to view the application information, such as tenant ID, client ID, and other details.

4.3.4.2 Enable Azure Authentication From UFM

Azure authentication is disabled by default. To enable it, please refer to [Enabling Azure AD Authentication](#).

4.3.4.3 Azure Authentication Login Page

After enabling and configuring Azure AD authentication, an additional button will appear on the primary UFM login page labeled 'Sign In with Microsoft,' which will leads to the main Microsoft sign-in page:

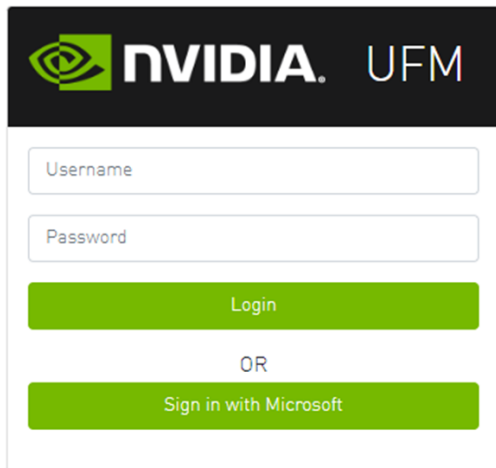

4.3.5 Kerberos Authentication

Kerberos is a network authentication protocol designed to provide strong authentication for client-server applications by using secret-key cryptography.

The Kerberos protocol works on the basis of tickets, it helps ensure that communication between various entities in a network is secure. It uses symmetric-key cryptography, which means both the client and servers share secret keys for encrypting and decrypting communication.

To enable Kerberos Authentication, refer to [Enabling Kerberos Authentication](#).

4.3.5.1 Setting Up Kerberos Server Machine

To set up a system as a Kerberos server, perform the following:

1. Install the required packages:

```
#Redhat
sudo yum install krb5-libs krb5-server
# Ubuntu
sudo apt-get install krb5-kdc krb5-admin-server
```

2. Edit the Kerberos configuration file '`/etc/krb5.conf`' to reflect your realm, domain and other settings:

```
[libdefaults]
    default_realm = YOUR-REALM

[realms]
    YOUR-REALM = {
        kdc = your-kdc-server
        admin_server = your-admin-server
    }

[domain_realm]
    your-domain = YOUR-REALM
    your-domain = YOUR-REALM
```

3. Use the `kdb5_util` command to create the Kerberos database:

```
kdb5_util create -r YOUR-REALM -s
```

4. Add administrative principals:

```
kadmin.local addprinc -randkey HTTP/YOUR-HOST-NAME@YOUR-REALM
```

5. Start KDC and Kadmin services:

```
sudo systemctl start krb5kdc kadmin
sudo systemctl enable krb5kdc kadmin
```

6. Generate a keytab file. The keytab file contains the secret key for a principal and is used to authenticate the service.

```
kadmin.local ktadd -k /path/to/your-keytab-file HTTP/YOUR-HOST-NAME@YOUR-REALM
```

Replace `/path/to/your-keytab-file` with the actual path where you want to store the keytab file.

4.3.5.2 Setting Up Kerberos Client Machine

Follow the below steps to set up a system as a Kerberos client.

1. Install the required packages. When installing the UFM, the following packages will be installed as dependencies:

```
#Redhat
krb5-libs krb5-workstation mod_auth_gssapi
# Ubuntu
krb5-config krb5-user libapache2-mod-auth-gssapi
```

2. Configure the `/etc/krb5.conf` file to reflect your realm, domain, local names map and other settings:

```
kinit -k -t /path/to/your-keytab-file HTTP/YOUR-HOST-NAME@YOUR-REALM
```

```
[libdefaults]
    default_realm = YOUR-REALM

[realms]
    YOUR-REALM = {
        kdc = your-kdc-server
        admin_server = your-admin-server
        auth_to_local_names = {
            your-principle-name = your-local-user
        }
    }

[domain_realm]
    your-domain = YOUR-REALM
    your-domain = YOUR-REALM
```

3. Copy the keytab file from the Kerberos server to the machine where your service runs (the client). It is important to ensure that it is kept confidential. Please ensure that the keytab file exists and that Apache has the necessary read permissions to access the keytab file; otherwise, Kerberos authentication will not function properly.
4. Obtain a Kerberos ticket-granting ticket (TGT):
5. Enable Kerberos Authentication from UFM. Kerberos authentication is disabled by default. To enable it, please refer to [Enabling Kerberos Authentication](#).
6. Test the Kerberos Authentication. You can use curl to test whether the user can authenticate to UFM REST APIs using Kerberos.

```
curl --negotiate -i -u : -k 'https://ufmc-eos01/ufmRestKrb/app/tokens'
```

5 UFM Server Health Monitoring

The UFM Server Health Monitoring module is a standalone module that monitors UFM resources and processes according to the settings in the `/opt/ufm/files/conf/UFMHealthConfiguration.xml` file.

For example:

- Each monitored resource or process has its own failure condition (number of retries and/or timeout), which you can configure.
- If a test fails, UFM will perform a *corrective operation*, if defined for the process, for example, to restart the process. You can change the configured corrective operation. If the corrective operation is set to "None", after the defined number of failures, the *give-up* operation is performed.
- If a test reaches the configured threshold for the number of retries, the health monitoring initiates the *give-up* operation defined for the process, for example, UFM failover or stop.
- By default, events and alarms are sent when a process fails, and they are also recorded in the internal log file.

Each process runs according to its own defined schedule, which you can change in the configuration file.

Changes to the configuration file take effect only after a UFM Server restart. (It is possible to kill and run in background the process `nohup python /opt/ufm/ufmhealth/UfmHealthRunner.pyo &.`)

You can also use the configuration file to improve disk space management by configuring:

- How often to purge MySQL binary log files.
- When to delete compressed UFM log files (according to free disk space).

The settings in the `/opt/ufm/files/conf/UFMHealthConfiguration.xml` file are also used to generate the UFM Health Report.

The following section describes the configuration file options for UFM server monitoring.

5.1 UFM Health Configuration

The UFM health configuration file contains three sections:

- Supported Operations—This section describes all the operations that can be used in tests, and their parameters.
- Supported Tests—This section describes all the tests. Each test includes:
 - The main test operation.
 - A corrective operation, if the main operation fails.
 - A give-up operation, if the main operation continues to fail after the corrective operation and defined number of retries.

The number of retries and timeout is also configured for each test operation.

- Test Schedule - This section lists the tests in the order in which they are performed and their configured frequency.

The following table describes the default settings in the `/opt/ufm/files/conf/UFMHealthConfiguration.xml` file for each test. The tests are listed in the order in which they are performed in the default configuration file.

You might need to modify the default values depending on the size of your fabric.

For example, in a large fabric, the SM might not be responsive for *sminfo* for a long time; therefore, it is recommended to increase the values for timeout and number of retries for *SMResponseTest*.

Recommended configurations for *SMResponseTest* are:

- For a fabric with 5000 nodes:
 - Number of retries = 12
 - Frequency = 10
- For a fabric with 10000 nodes:
 - Number of retries = 12
 - Frequency = 20

Test Name / Description	Test Operation	Corrective Operation (if Test Operation fails)	No. Retries / Give-up Operation	Test Frequency
CpuUsageTest Checks total CPU utilization.	CPUTest Tests that overall CPU usage does not exceed 80% (this percentage is configurable).	None If UFM Event Burst Management is enabled, it is automatically initiated when the test operation fails	1 Retry None	1 minute
AvailableDiskSpaceTest Checks available disk space.	FreeDiskTest Tests that disk space usage for <i>/opt/ufm</i> does not exceed 90% (this percentage is configurable).	CleanDisk Delete compressed UFM log files under <i>/opt/ufm</i>	3 Retries None	1 hour
CheckIBFabricInterface Checks state of active fabric interface.	IBInterfaceTest Tests that active fabric interface is up.	BringUpIBFabricInterface Bring up the fabric interface	3 Retries SMOrUFMFailoverOrDoNothing	35 seconds
CheckIBFabricInterfaceStandby (HA only) Checks state of fabric interface on standby.	IBInterfaceTestOnStandby Tests that fabric interface on standby is up.	None	1 Retry None	1 minute
MemoryTest Checks total memory usage.	MemoryUsageTest Tests that memory usage does not exceed 90% (this percentage is configurable).	None	1 Retry None	1 minute
SMProcessTest Checks status of the OpenSM service.	SMRunningTest Tests that the SM process is running.	RestartProcess Restart the SM process	1 Retry UFMFailoverOrDoNothing	10 seconds
SMResponseTest Checks responsiveness of SM (when SM process is running).	SMTTest Tests SM responsiveness by sending the <i>sminfo</i> query to SM.	None	9 Retries UFMFailoverOrDoNothing	10 seconds

Test Name / Description	Test Operation	Corrective Operation (if Test Operation fails)	No. Retries / Give-up Operation	Test Frequency
IbpmTest Checks status of the IBPM (Performance Manager) service.	ProcessIsRunningTest Tests that the IBPM service is running.	RestartProcess Restart the IBPM service	3 Retries None	1 minute
ModelMainTest Checks status of the main UFM service	ProcessIsRunningTest Tests that the UFM service is running.	RestartProcess Restart the UFM service	3 Retries UFMFailoverOrDoNot hing	20 seconds
HttpdTest Checks status of the httpd service.	ProcessIsRunningTest Tests that the httpd service is running.	RestartProcess Restart the httpd service	3 Retries None	20 seconds
MySqlTest Checks status of the MySql service.	ConnectToMySql Tests that the MySql service is running.	None	1 Retry UFMFailoverOrDoNot hing	20 seconds
CleanMySql Purges MySql Logs	AlwaysFailTest Fails the test in order to perform the corrective action.	PurgeMySqlLogs Purge all MySql Logs on each test	1 Retry None	24 hours
UFMServerVersionTest Checks UFM software version and build.	UfmVersionTest Returns UFM software version information.	None	1 Retry None	24 hours
UFMServerLicenseTest Checks UFM License information.	UfmLicenseTest Returns UFM License information.	None	1 Retry None	24 hours
UFMServerHAConfiguration Test (HA only) Checks the configuration on master and standby.	UfmHAConfigurationTest Returns information about the master and standby UFM servers.	None	1 Retry None	24 hours
UFMMemoryTest Checks available UFM memory.	UfmMemoryUsageTest Tests that UFM memory usage does not exceed 80% (this percentage is configurable).	None	1 Retry None	1 minute
UFMCpuUsageTest Checks UFM CPU utilization.	CPUTest Tests that UFM CPU usage does not exceed 60% (this percentage is configurable).	None	1 Retry None	1 minute
CheckDrbdTcpConnectionPerformanceTest (HA only) Checks the tcp connection between master and standby	TcpConnectionPerformanceTest Tests that bandwidth is greater than 100 Mb/sec and latency is less than 70 usec (configurable).	None	2 Retry None	10 minute

The Supported Operations section of the configuration file includes additional optional operations that can be used as corrective operations or give-up operations.

5.1.1 UFM Core Files Tracking

To receive a notification every time OpenSM or ibpm creates a core dump, please refer to the list of all current core dumps of OpenSM and ibpm in the UFM health report.

➤ To receive core dump notifications, do the following:

1. Set the `core_dumps_directory` field in the `gv.cfg` file to point to the location where all core dumps are created (by default, this location is set to `/tmp`).

```
core_dumps_directory = /tmp
```

2. Set the naming convention for the core dump file. The name must include the directory configured in the step above.

The convention we recommend is:

```
echo "/tmp/%t.core.%e.%p.%h" > /proc/sys/kernel/core_pattern
```

3. Make sure core dumps directory setting is persistent between reboots. Add the `kernel.core_pattern` parameter with the desired file name format to the `/etc/systctl.conf` file. Example:

```
kernel.core_pattern=/tmp/%t.core.%e.%p.%h
```

4. Configure the core file size to be unlimited.

```
ulimit -c unlimited
```

5. (Only on UFM HA master) Update the UFM configuration file `gv.cfg` to enable core dump tracking.

```
track_core_dumps = yes
```

5.2 Example of Health Configuration

The default configuration for the overall memory test in the `opt/ufm/files/conf/UFMHealthConfiguration.xml` file is:

```
<Test Name="MemoryTest" NumOfRetriesBeforeGiveup="3" RetryTimeoutInSeconds="10">
  <TestOperation Name="MemoryUsageTest">
    <Parameters>
      <Parameter Name="ThresholdInPercents" Value="90"/>
    </Parameters>
  </TestOperation>
  <CorrectiveOperation Name="None"/>
  <GiveupOperation Name="None"/>
</Test>
```

This configuration tests the available memory. If memory usage exceeds 90%, the test is repeated up to 3 times at 10 second intervals, or until memory usage drops to below 90%. No corrective action is taken and no action is taken after 3 retries.

To test with a usage threshold of 80%, and to initiate UFM failover or stop UFM after three retries, change the configuration to:

```
<Test Name="MemoryTest" NumOfRetriesBeforeGiveup="3" RetryTimeoutInSeconds="10">
  <TestOperation Name="MemoryUsageTest">
    <Parameters>
      <Parameter Name="ThresholdInPercents" Value="80"/>
    </Parameters>
  </TestOperation>
  <CorrectiveOperation Name="None"/>
  <GiveupOperation Name="UFMFailoverOrStop"/>
</Test>
```

5.2.1 Event Burst Management

UFM event burst management can lower the overall CPU usage following an event burst by suppressing events. Event burst management is configured in the *gv.cfg* configuration file.

When the overall CPU usage exceeds the threshold configured by the *CpuUsageTest* in the */opt/ufm/files/conf/UFMHealthConfiguration.xml* file, a High CPU Utilization event occurs.

This event initiates the UFM event burst management, which:

- Suppresses events. The default level of suppression enables critical events only.
- If, after a specified period of time (30 seconds, by default), no further High CPU Utilization event occurs, the UFM server enables all events.

To modify Event burst management configuration, change the following parameters in the *gv.cfg* file:

```
# The events' level in case events are suppressed (the possible levels are disable_all_events,
enable_critical_events, and enable_all_events)
# The entire feature can be turned off using the level "enable_all_events"
suppress_events_level = enable_critical_events
# The amount of time in seconds which events are suppressed
suppress_events_timeout = 30
```

6 Events and Alarms

UFM offers comprehensive diagnostics for your InfiniBand fabric, covering a range of categories:

1. Fabric configurations
2. Fabric topology
3. Hardware issues
4. Communication errors
5. Maintenance
6. Security
7. Switch module status
8. NVIDIA SHARP notifications

Events are notifications generated by UFM, indicating issues within the mentioned categories in the InfiniBand fabric. On the other hand, alerts are urgent notifications derived from events (many events can be configured as alarms based on customer preferences).

These detections are performed both before running applications and during standard operation. They help troubleshoot and notify network administrators of potential network issues before they escalate.

Events can originate from various sources:

- SM traps
- SHARP AM traps
- UFM internal analysis, encompassing:
 - Internal detection of topology changes
 - Internal fabric analysis (based on IBDiagnet)
 - Internal monitoring of managed switches
 - Maintenance activities (device action tracking, licensing, cable integrity)
- Threshold-crossing events determined by telemetry counter readings

	WebUI	REST API
Events	UFM events can be viewed via the Events and Alarms WebUI view. Refer to Events & Alarms .	Events REST API
	For device-specific events, refer to the Events & Alarms .	N/A
	Configuration of events is managed within the Events Policy Tab in the Settings window	Events Policy REST API
Alarms	UFM alarms can be viewed via the Events and Alarms WebUI view. Refer to Events & Alarms .	Alarms REST API
	Configuration of alarms is managed within the Events Policy Tab in the Settings window	N/A

For showing all the UFM supported events, refer to [Threshold-Crossing Events Reference](#).

6.1 Threshold-Crossing Events Reference

This reference lists the threshold-based events that UFM supports, each including a set of attributes listed below. You can view these messages through TBD. For details about configuring notifications for these events, refer to TBD.

- Event ID: Unique event identifier
- Event Name: Short description of the event
- To log: A flag which defines whether the event will be sent to UFM events log or not (1 or 0, respectively).
- Alarm: A flag which defines whether UFM alarm is generated when the specified event is triggered by UFM (1 means an alarm is generated). Alarms are used to allow a notification with significant indication.
- Default Severity: Indicates the alarm severity (Info, Warning, Minor, Critical)
- Default Threshold: Event dependent threshold (for example, event occurrence, counter threshold or temperature threshold).
- Default TTL: TTL (Alarm Time to Live) sets the time during which the alarm on the event is visible on UFM Web UI. TTL is defined in seconds. CAUTION: Setting the TTL to 0 makes the alarm permanent, meaning that the alarm does not disappear from the Web UI until cleared manually.
- Related Object: The object (context) to which the UFM event is related to (port, switch, gateway, grid, etc).
- Category: Indicates the category to which the event is related to.
- Source: Indicates the origin source of the specified event (SM, Telemetry, Licensing, UFM)

For information about defining event policy, see [Configuring Event Management](#).

Event ID	Event Name	To Log	Alarm	Default Severity	Default Threshold	Default TTL	Related Object	Category	Source
64	GID Address In Service	1	0	Info	1	300	Port	Fabric Notification	SM
65	GID Address Out of Service	1	0	Warning	1	300	Port	Fabric Notification	SM
66	New MCast Group Created	1	0	Info	1	300	Port	Fabric Notification	SM
67	MCast Group Deleted	1	0	Info	1	300	Port	Fabric Notification	SM
110	Symbol Error	1	1	Warning	200	300	Port	Hardware	Telemetry
111	Link Error Recovery	1	1	Minor	1	300	Port	Hardware	Telemetry

Event ID	Event Name	T o L o g	Alarm	Default Severity	Default Threshold	Default TTL	Related Object	Category	Source
112	Link Downed	1	1	Critical	1	300	Port	Hardware	Telemetry
113	Port Receive Errors	1	1	Minor	5	300	Port	Hardware	Telemetry
114	Port Receive Remote Physical Errors	0	0	Minor	5	300	Port	Hardware	Telemetry
115	Port Receive Switch Relay Errors	1	1	Minor	999	300	Port	Fabric Configuration	Telemetry
116	Port Xmit Discards	1	1	Minor	200	300	Port	Communication Error	Telemetry
117	Port Xmit Constraint Errors	1	1	Minor	200	300	Port	Communication Error	Telemetry
118	Port Receive Constraint Errors	1	1	Minor	200	300	Port	Communication Error	Telemetry
119	Local Link Integrity Errors	1	1	Minor	5	300	Port	Hardware	Telemetry
120	Excessive Buffer Overrun Errors	1	1	Minor	100	300	Port	Communication Error	Telemetry
121	VL15 Dropped	1	1	Minor	50	300	Port	Communication Error	Telemetry
122	Congested Bandwidth (%) Threshold Reached	1	1	Minor	10	300	Port	Hardware	Telemetry
123	Port Bandwidth (%) Threshold Reached	1	1	Minor	95	300	Port	Communication Error	Telemetry
130	Non-optimal link width	1	1	Minor	1	0	Port	Hardware	SM
134	T4 Port Congested Bandwidth	1	1	Warning	10	300	Port	Communication Error	Telemetry
141	Flow Control Update Watchdog Timer Expired	1	0	Warning	1	300	Port	Hardware	SM
144	Capability Mask Modified	1	0	Info	1	300	Port	Fabric Notification	SM
145	System Image GUID changed	1	0	Info	1	300	Port	Communication Error	SM
156	Link Speed Enforcement Disabled	1	0	Critical	0	300	Site	Fabric Notification	SM
250	Running in Limited Mode	1	1	Critical	1	0	Grid	Maintenance	Licensing
251	Switching to Limited Mode	1	1	Critical	1	0	Grid	Maintenance	Licensing

Event ID	Event Name	T o L o g	Alarm	Default Severity	Default Threshold	Default TTL	Related Object	Category	Source
252	License Expired	1	1	Warning	1	0	Grid	Maintenance	Licensing
253	Duplicated licenses	1	0	Critical	1	0	Grid	Maintenance	Licensing
254	License Limit Exceeded	1	0	Critical	1	0	Grid	Maintenance	Licensing
255	License is About to Expire	1	0	Warning	1	0	Grid	Maintenance	Licensing
256	Bad M_Key	1	0	Minor	1	300	Port	Security	SM
257	Bad P_Key	1	0	Minor	1	300	Port	Security	SM
258	Bad Q_Key	1	0	Minor	1	300	Port	Security	SM
259	Bad P_Key Switch External Port	1	0	Critical	1	300	Port	Security	SM
328	Link is Up	1	0	Info	1	0	Link	Fabric Topology	SM
329	Link is Down	1	0	Warning	1	0	Site	Fabric Topology	SM
331	Node is Down	1	0	Warning	1	0	Site	Fabric Topology	SM
332	Node is Up	1	0	Info	1	300	Site	Fabric Topology	SM
336	Port Action Succeeded	1	0	Info	1	0	Port	Maintenance	UFM
337	Port Action Failed	1	0	Minor	1	0	Port	Maintenance	UFM
338	Device Action Succeeded	1	0	Info	1	0	Port	Maintenance	UFM
339	Device Action Failed	1	0	Minor	1	0	Port	Maintenance	UFM
344	Partial Switch ASIC Failure	1	1	Critical	1	0	Switch	Maintenance	UFM
370	Gateway Ethernet Link State Changed	1	0	Warning	1	0	Gateway	Gateway	SM
371	Gateway Reregister Event Received	1	0	Warning	1	0	Gateway	Gateway	SM
372	Number of Gateways Changed	1	0	Warning	1	0	Gateway	Gateway	SM
373	Gateway will be Rebooted	1	0	Warning	1	0	Gateway	Gateway	SM
374	Gateway Reloading Finished	1	0	Info	1	0	Gateway	Gateway	SM

Event ID	Event Name	T O L o g	Alarm	Default Severity	Default Threshold	Default TTL	Related Object	Category	Source
380	Switch Upgrade Error	1	1	Critical	1	0	Switch	Maintenance	UFM
381	Switch Upgrade Failed	1	0	Info	1	0	Switch	Maintenance	UFM
328	Module status NOT PRESENT	1	1	Warning	1	420	Switch	Module Status	UFM
383	Host Upgrade Failed	1	0	Info	1	0	Computer	Maintenance	UFM
384	Switch Module Powered Off	1	1	Info	1	420	Switch	Module Status	UFM
385	Switch FW Upgrade Started	1	0	Info	1	0	Switch	Maintenance	UFM
386	Switch SW Upgrade Started	1	0	Info	1	0	Switch	Maintenance	UFM
387	Switch Upgrade Finished	1	0	Info	1	0	Switch	Maintenance	UFM
388	Host FW Upgrade Started	1	0	Info	1	0	Computer	Maintenance	UFM
389	Host SW Upgrade Started	1	0	Info	1	0	Computer	Maintenance	UFM
391	Switch Module Removed	1	0	Info	1	0	Switch	Fabric Notification	Switch
392	Module Temperature Threshold Reached	1	0	Info	40	0	Module	Hardware	Switch
393	Switch Module Added	1	0	Info	1	0	Switch	Fabric Notification	Switch
394	Module Status FAULT	1	1	Critical	1	420	Switch	Module Status	Switch
395	Device Action Started	1	0	Info	1	0	Port	Maintenance	UFM
396	Site Action Started	1	0	Info	1	0	Port	Maintenance	UFM
397	Site Action Failed	1	0	Minor	1	0	Port	Maintenance	UFM
398	Switch Chip Added	1	0	Info	1	0	Switch	Fabric Notification	Switch
399	Switch Chip Removed	1	0	Critical	1	0	Switch	Fabric Notification	Switch

Event ID	Event Name	T o L o g	Alar m	Defa ult Seve rity	Defau lt Thres hold	Defa ult TTL	Relat ed Obje ct	Category	Sourc e
403	Device Pending Reboot	1	1	Warnin g	0	300	Device	Maintenanc e	UFM
404	System Information is missing	1	1	Warnin g	1	300	Switch	Communic ation Error	UFM
405	Switch Identity Validation Failed	1	1	Warnin g	1	300	Switch	Communic ation Error	UFM
406	Switch System Information is missing	1	1	Waring	1	300	Switch	Communic ation Error	UFM
407	COMEX Ambient Temperature Threshold Reached	1	1	Minor	60	300	Switch	Hardware	Switch
408	Switch is Unresponsive	1	1	Critica l	1	300	Switch	Communic ation Error	UFM
502	Device Upgrade Finished	1	0	Info	1	300	Device	Maintenanc e	UFM
506	Device Upgrade Finished	1	0	Info	1	300	Device	Maintenanc e	UFM
508	Core Dump Created	1	1	Info	1	300	Grid	Maintenanc e	UFM
510	SM Failover	0	1	Critica l	1	300	Grid	Fabric Notificatio n	SM
511	SM State Change	0	1	Info	1	300	Grid	Fabric Notificatio n	SM
512	SM UP	0	1	Info	1	300	Grid	Fabric Notificatio n	SM
513	SM System Log Message	0	1	Minor	1	300	Grid	Fabric Notificatio n	SM
514	SM LID Change	0	1	Warnin g	1	300	Grid	Fabric Notificatio n	SM
515	Fabric Health Report Info	1	1	Info	1	300	Grid	Fabric Notificatio n	UFM
516	Fabric Health Report Warning	1	1	Warnin g	1	300	Grid	Fabric Notificatio n	UFM
517	Fabric Health Report Error	1	1	Critica l	1	300	Grid	Fabric Notificatio n	UFM
518	UFM-related process is down	1	1	Critica l	1	300	Grid	Maintenanc e	UFM

Event ID	Event Name	T o L o g	Alar m	Defau lt Seve rity	Defau lt Thres hold	Defau lt TTL	Relat ed Obje ct	Category	Sourc e
519	Logs purge failure	1	1	Minor	1	300	Grid	Maintenanc e	UFM
520	Restart of UFM-related process succeeded	1	1	Info	1	300	Grid	Maintenanc e	UFM
521	UFM is being stopped	1	1	Critica l	1	300	Grid	Maintenanc e	UFM
522	UFM is being restarted	1	1	Critica l	1	300	Grid	Maintenanc e	UFM
523	UFM failover is being attempted	1	1	Info	1	300	Grid	Maintenanc e	UFM
524	UFM cannot connect to DB	1	1	Critica l	1	300	Grid	Maintenanc e	UFM
525	Disk utilization threshold reached	1	1	Critica l	1	300	Grid	Maintenanc e	UFM
526	Memory utilization threshold reached	1	1	Critica l	1	300	Grid	Maintenanc e	UFM
527	CPU utilization threshold reached	1	1	Critica l	1	300	Grid	Maintenanc e	UFM
528	Fabric interface is down	1	1	Critica l	1	300	Grid	Maintenanc e	UFM
529	UFM standby server problem	1	1	Critica l	1	300	Grid	Maintenanc e	UFM
530	SM is down	1	1	Critica l	1	300	Grid	Maintenanc e	UFM
531	DRBD Bad Condition	1	1	Critica l	1	300	Grid	Maintenanc e	UFM
532	Remote UFM-SM Sync	1	1	Info	1	0	Grid	Maintenanc e	UFM
533	Remote UFM-SM problem	1	1	Critica l	1	0	Site	Maintenanc e	UFM
535	MH Purge Failed	1	1	Warnin g	1	300	Grid	Maintenanc e	UFM
536	UFM Health Watchdog Info	1	1	Info	1	300	Grid	Maintenanc e	UFM
537	UFM Health Watchdog Critical	1	1	Critica l	1	300	Grid	Maintenanc e	UFM
538	Time Diff Between HA Servers	1	1	Warnin g	1	300	Grid	Maintenanc e	UFM
539	DRBD TCP Connection Performance	1	1	Warnin g	1	900	Grid	Maintenanc e	UFM
540	Daily Report Completed successfully	1	0	Info	1	300	Grid	Maintenanc e	UFM

Event ID	Event Name	T O L o g	Alarm	Default Severity	Default Threshold	Default TTL	Related Object	Category	Source
541	Daily Report Completed with Error	1	0	Minor	1	300	Grid	Maintenance	UFM
542	Daily Report Failed	1	0	Critical	1	300	Grid	Maintenance	UFM
543	Daily Report Mail Sent successfully	1	0	Info	1	300	Grid	Maintenance	UFM
544	Daily Report Mail Sent Failed	1	0	Minor	1	300	Grid	Maintenance	UFM
545	SM is not responding	1	1	Critical	1	300	Grid	Maintenance	UFM
560	User Connected							Security	UFM
561	User Disconnected							Security	UFM
602	UFM Server Failover	1	1	Critical	1	0	Site	Fabric Notification	UFM
603	Events Suppression	1	0	Critical	0	300	Site	Maintenance	UFM
604	Report Succeeded	1	1	Info	1	300	Grid	Maintenance	UFM
605	Report Failed	1	1	Critical	1	300	Grid	Maintenance	UFM
606	Correction Attempts Paused	1	0	Warning	1	0	Site	Fabric Notification	UFM
701	Non-optimal Link Speed	1	1	Minor	1	0	Port	Hardware	UFM
702	Unhealthy IB Port	1	1	Warning	1	0	Port	Hardware	SM
703	Fabric Collector Connected	1	0	Info	1	0	Grid	Maintenance	UFM
704	Fabric Collector Disconnected	1	1	Critical	1	0	Grid	Maintenance	UFM
750	High data retransmission count on port	1	1	Warning	500	1	Port	Hardware	SM
901	Fabric Configuration Started	0	1	Info	1	0	Grid	Fabric Notification	UFM
902	Fabric Configuration Completed	0	1	Info	1	0	Grid	Fabric Notification	UFM
903	Fabric Configuration Failed	0	1	Critical	1	0	Grid	Fabric Notification	UFM

Event ID	Event Name	T o L o g	Alar m	Defa ult Seve rity	Defau lt Thres hold	Defa ult TTL	Relat ed Obje ct	Category	Sourc e
904	Device Configuration Failure	0	1	Critica l	1	0	Device	Fabric Notificatio n	UFM
905	Device Configuration Timeout	0	1	Critica l	1	0	Device	Fabric Notificatio n	UFM
906	Provisioning Validation Failure	0	1	Critica l	1	0	Grid	Fabric Notificatio n	UFM
907	Switch is Down	1	1	Critica l	1	0	Site	Fabric Topology	UFM
908	Switch is Up	1	1	Info	1	300	Site	Fabric Topology	UFM
909	Director Switch is Down	1	1	Critica l	1	300	Site	Fabric Topology	UFM
910	Director Switch is Up	1	1	Info	1	0	Site	Fabric Topology	UFM
911	Module Temperature Low Threshold Reached	1	1	Warnin g	60	300	Module	Hardware	Teleme try
912	Module Temperature High Threshold Reached	1	1	Critica l	60	300	Module	Hardware	Teleme try
913	Module High Voltage	1	1	Warnin g	10	420	Switch	Module Status	Teleme try
914	Module High Current	1	1	Warnin g	10	420	Switch	Module Status	Teleme try
915	BER_ERROR	1	1	Critica l	1e-8	420	Port	Hardware	Teleme try
916	BER_WARNING	1	1	Warnin g	1e-13	420	Port	Hardware	Teleme try
917	SYMBOL_BER_ERROR	1	1	Critica l	10	420	Port	Hardware	Teleme try
918	High Symbol BER reported	1	1	Warnin g	10	420	Port	Hardware	Teleme try
919	Cable Temperature High	1	1	Critica l	0	0	Port	Hardware	Teleme try
920	Cable Temperature Low	1	1	Critica l	0	0	Port	Hardware	Teleme try
1300	SM_SAKY_VIOLATION	1	1	Warnin g		5300	Port	Security	SM
1301	SM_SGID_SPOOFED	1	1	Warnin g		5300	Port	Security	SM
1302	SM_RATE_LIMIT_EXCEEDED	1	1	Warnin g		5300	Port	Security	SM

Event ID	Event Name	T O L O g	Alarm	Default Severity	Default Threshold	Default TTL	Related Object	Category	Source
1303	SM_MULTICAST_GROUPS_LIMIT_EXCEEDED	1	1	Warning		5300	Port	Security	SM
1304	SM_SERVICES_LIMIT_EXCEEDED	1	1	Warning		5300	Port	Security	SM
1305	SM_EVENT_SUBSCRIPTION_LIMIT_EXCEEDED	1	1	Warning		5300	Port	Security	SM
1306	Unallowed SM was detected in the fabric	1	1	Warning	0	300	Port	Fabric Notification	SM
1307	SMInfo SET request was received from unallowed SM	1	1	Warning	0	300	Port	Fabric Notification	SM
1309	SM was detected with non-matching SMKey	1	1	Warning	0	300	Port	Fabric Notification	SM
1310	Duplicated node GUID was detected	1	1	Critical	1	0	Device	Fabric Notification	SM
1311	Duplicated port GUID was detected	1	1	Critical	1	0	Port	Fabric Notification	SM
1312	Switch was Rebooted	1	1	Info	1	0	Device	Fabric Notification	UFM
1315	Topo Config File Error	1	1	Critical	1	0	Grid	Fabric Notification	UFM
1316	Topo Config Subnet Mismatch	1	1	Critical	1	0	Grid	Fabric Notification	Topodiff
1400	High Ambient Temperature	1	1	Warning	0	86400	Switch	Hardware	Switch
1401	High Fluid Temperature	1	1	Warning	0	86400	Switch	Hardware	Switch
1402	Low Fluid Level	1	1	Warning	0	86400	Switch	Hardware	Switch
1403	Low Supply Pressure	1	1	Warning	0	86400	Switch	Hardware	Switch
1404	High Supply Pressure	1	1	Warning	0	86400	Switch	Hardware	Switch
1405	Low Return Pressure	1	1	Warning	0	86400	Switch	Hardware	Switch
1406	High Return Pressure	1	1	Warning	0	86400	Switch	Hardware	Switch

Event ID	Event Name	T O L o g	Alarm	Default Severity	Default Threshold	Default TTL	Related Object	Category	Source
1407	High Differential Pressure	1	1	Warning	0	86400	Switch	Hardware	Switch
1408	Low Differential Pressure	1	1	Warning	0	86400	Switch	Hardware	Switch
1409	System Fail Safe	1	1	Warning	0	86400	Switch	Hardware	Switch
1410	Fault Critical	1	1	Critical	0	86400	Switch	Hardware	Switch
1411	Fault Pump1	1	1	Critical	0	86400	Switch	Hardware	Switch
1412	Fault Pump2	1	1	Critical	0	86400	Switch	Hardware	Switch
1413	Fault Fluid Level Critical	1	1	Critical	0	86400	Switch	Hardware	Switch
1414	Fault Fluid Over Temperature	1	1	Critical	0	86400	Switch	Hardware	Switch
1415	Fault Primary DC	1	1	Critical	0	86400	Switch	Hardware	Switch
1416	Fault Redundant DC	1	1	Critical	0	86400	Switch	Hardware	Switch
1417	Fault Fluid Leak	1	1	Critical	0	86400	Switch	Hardware	Switch
1418	Fault Sensor Failure	1	1	Critical	0	86400	Switch	Hardware	Switch
1419	Cooling Device Monitoring Error	1	0	Critical	0	1	Grid	Hardware	Switch
1420	Cooling Device Communication Error	1	1	Critical	0	86400	Switch	Hardware	Switch
1500	New cable detected	1	0	Info	1	0	Link	Security	UFM
1502	Cable detected in a new location	1	0	Warning	1	0	Link	Security	UFM
1503	Duplicate Cable Detected	1	0	Critical	1	0	Link	Security	UFM
1315	Topo Config File Error	1	1	Critical	1	0	Grid	Fabric Notification	UFM
1504	SHARP Allocation Succeeded	1	1	Info	1	0	Grid	SHARP	SHARP
1505	SHARP Allocation Failed	1	0	Warning	1	0	Grid	SHARP	SHARP
1506	SHARP Deallocation Succeeded	1	0	Info	1	0	Grid	SHARP	SHARP
1507	SHARP Deallocation Failed	1	0	Warning	1	0	Grid	SHARP	SHARP

Event ID	Event Name	T O L o g	Alarm	Default Severity	Default Threshold	Default TTL	Related Object	Category	Source
1508	Device Collect System Dump Started	1	0	Info	1	300	Device	Maintenance	UFM
1509	Device Collect System Dump Finished	1	0	Info	1	300	Device	Maintenance	UFM
1510	Device Collect System Dump Error	1	0	Critical	1	300	Device	Maintenance	UFM
1511	Virtual Port Added	1	0	Info	1	0	Port	Fabric Notification	SM
1512	Virtual Port Removed	1	0	Warning	1	0	Port	Fabric Notification	SM
1513	Burn Cables Transceivers Started	1	0	Info	1	0	Device	Maintenance	UFM
1514	Burn Cables Transceivers Finished	1	0	Info	1	0	Device	Maintenance	UFM
1515	Burn Cables Transceivers Failed	1	0	Warning	1	0	Device	Maintenance	UFM
1516	Activate Cables Transceivers FW Finished	1	0	Info	1	0	Device	Maintenance	UFM
1517	Activate Cables Transceivers FW Failed	1	0	Warning	1	0	Device	Maintenance	UFM
1520	Aggregation Node Discovery Failed	1	0	Critical	1	0	SHARP AM	SHARP	SHARP
1521	Job Started	1	0	Info	1	0	SHARP AM	SHARP	SHARP
1522	Job Ended	1	0	Info	1	0	SHARP AM	SHARP	SHARP
1523	Job Start Failed	1	0	Critical	1	0	SHARP AM	SHARP	SHARP
1524	Job Error	1	0	Critical	1	0	SHARP AM	SHARP	SHARP
1525	Trap QP Error	1	0	Critical	1	0	SHARP AM	SHARP	SHARP
1526	Trap Invalid Request	1	0	Critical	1	0	SHARP AM	SHARP	SHARP
1527	Trap Sharp Error	1	0	Critical	1	0	SHARP AM	SHARP	SHARP
1528	Trap QP Alloc timeout	1	0	Critical	1	0	SHARP AM	SHARP	SHARP
1529	Trap AMKey Violation	1	0	Critical	1	0	SHARP AM	SHARP	SHARP

Event ID	Event Name	T o L o g	Alar m	Defau lt Seve rity	Defau lt Thres hold	Defau lt TTL	Relat ed Obje ct	Category	Sourc e
1530	Unsupported Trap	1	0	Critica l	1	0	SHARP AM	SHARP	SHARP
1531	Reservation Updated	1	0	Info	1	0	SHARP AM	SHARP	SHARP
1532	Sharp is not Responding	1	0	Critica l	1	0	SHARP AM	SHARP	SHARP
1533	Agg Node Active	1	0	Info	1	0	SHARP AM	SHARP	SHARP
1534	Agg Node Inactive	1	0	Warnin g	1	0	SHARP AM	SHARP	SHARP
1535	Trap AMKey Violation Triggered by AM	1	0	Warnin g	1	0	SHARP AM	SHARP	SHARP
1550	Guids Were Added to Pkey	1	0	Info	1	0	Port	Fabric Notificatio n	UFM
1551	Guids Were Removed from Pkey	1	0	Info	1	0	Port	Fabric Notificatio n	UFM
1600	VS/CC Classes Key Violation							Security	SM
1602	PCI Speed Degradation Warning	1	1	Warnin g	1	0	Port	Fabric Notificatio n	UFM
1603	PCI Width Degradation Warning	1	1	Warnin g	1	0	Port	Fabric Notificatio n	UFM

7 Reports

UFM reports provide summarized information about selected topics. Through the different UFM WebUI tabs, you can create reports that run a series of checks on UFM components.

The table below summarizes the types of reports and provides useful links for more information.

Report Type	Description	WebUI	REST API
UFM Health Report	A report that run a series of checks related to UFM server health, including CPU, memory, license, configurations and disk monitoring.	UFM Health Tab	Reports REST API
Fabric Health Report	Through the Fabric Health tab, you can access the fabric health reports. There are two kinds of reports: <ul style="list-style-type: none">• Custom Reports - The user can generate a report that runs a series of checks on the fabric on demand.• Periodic Reports - An automatically generated report that is periodically generated by the UFM.	Fabric Health Tab	Reports REST API Periodic Fabric Health REST API
Topology Comparison Report	Reports on topology comparison, available as: <ul style="list-style-type: none">• Periodic Comparison - allows users to compare the current fabric topology with a preset master topology.• Custom Comparison - compares user-defined topology with the current fabric topology.	Topology Compare Tab	Topology Compare REST API
Daily Reports	The Daily Report feature collects, analyzes, and reports the most significant issues of the fabric in the last 24 hours	Daily Reports Tab	N/A

8 Telemetry2

UFM Telemetry allows the collection and monitoring of InfiniBand fabric port statistics, such as network bandwidth, congestion, errors, latency, and more.

UFM provides a range of telemetry capabilities:

- Real-time monitoring views
- Monitoring of multiple attributes
- Intelligent Counters for error and congestion counters
- InfiniBand port-based error counters
- InfiniBand congestion XmitWait counter-based congestion measurement
- InfiniBand port-based bandwidth data

The telemetry session panels support the following actions:

- Rearrangement via a straightforward drag-and-drop function
- Resizing by hovering over the panel's border

UFM Telemetry data is collected via UFM telemetry instances invoked during UFM startup.

Telemetry Instance	Description	REST API
High-Frequency (Primary) Telemetry Instance	<p>A default telemetry session that collects a predefined set of ~30 counters covering bandwidth, congestion, and error metrics, which UFM analyzes and reports.</p> <p>These counters are used for:</p> <ul style="list-style-type: none"> • Default Telemetry Session - An ongoing session used by the UFM to display UFM WebUI dashboard charts information and for monitoring and analyzing ports threshold events (the session interval is 30 secs by default) • Real-Time Telemetry - allows users to define live telemetry sessions for monitoring small subsets of devices or ports and a selected set of counters. For more information, refer to Telemetry - User-Defined Sessions • Historical Telemetry - based on the primary telemetry and collects statistical data from all fabric ports and stores them in an internal UFM SQLite database (the session interval is 5 mins by default) 	<p>For Default and Real-time Telemetry: Monitoring REST API</p> <p>For Historical Telemetry: History Telemetry Sessions REST API</p>
Low-Frequency (Secondary) Telemetry Instance	<p>Operates automatically upon UFM startup, offering an extended scope of 120 counters. For a list of the Secondary Telemetry Fields, refer to Low-Frequency (Secondary) Telemetry Fields.</p>	N/A

For direct telemetry endpoint access, which exposes the list of supported counters:

For the High-Frequency (Primary) Telemetry Instance, run the following command:

```
curl http://r-ufm114:9001/csv/cset/converted_enterprise
```

For the Low-Frequency (Secondary) Telemetry Instance, run the following command:

```
curl http://r-ufm114:9002/csv/xset/low_freq_debug
```

8.1 Historical Telemetry Collection in UFM

8.1.1 Storage Considerations

UFM periodically collects fabric port statistics and saves them in its SQLite database. Before starting up UFM Enterprise, please consider the following disk space utilization for various fabric sizes and duration.

The measurements in the table below were taken with sampling interval set to once per 30 seconds.

Be aware that the default sampling rate is once per 300 seconds. Disk utilization calculation should be adjusted accordingly.

Number of Nodes	Ports per Node	Storage per Hour	Storage per 15 Days	Storage per 30 Days
16	8	1.6 MB	576 MB (0.563 GB)	1152 MB (1.125 GB)
100	8	11 MB	3960 MB (3.867 GB)	7920 MB (7.734 GB)
500	8	50 MB	18000 MB (17.58 GB)	36000 MB (35.16 GB)
1000	8	100 MB	36000 MB (35.16 GB)	72000 MB (70.31 GB)

8.2 High-Frequency (Primary) Telemetry Fields

The following is a list of available counters which includes a variety of metrics related to timestamps, port and node information, error statistics, firmware versions, temperatures, cable details, power levels, and various other telemetry-related data.

Field Name	Description
timestamp	
source_id	
tag	
node_guid	node GUID
port_guid	Port GUID
port_num	Port Number
PortXmitDataExtended	Transmitted data rate per egress port in bytes passing through the port during the sample period
PortRcvDataExtended	The received data on the ingress port in bytes during the sample period

Field Name	Description
PortXmitPktsExtended	Total number of packets transmitted on the port.
PortRcvPktsExtended	Total number of packets received on the port
SymbolErrorCounterExtended	This counter provides information on error bits that were not corrected by phy correction mechanisms.
LinkErrorRecoveryCounterExtended	Total number of times the Port Training state machine has successfully completed the link error recovery process.
LinkDownedCounterExtended	Perf.PortCounters
PortRcvErrorsExtended	Total number of packets containing an error that were received on the port
PortRcvRemotePhysicalErrorsExtended	Total number of packets marked with the EBP delimiter received on the port.
PortRcvSwitchRelayErrorsExtended	Total number of packets received on the port that were discarded because they could not be forwarded by the switch relay.
PortXmitDiscardsExtended	Total number of outbound packets discarded by the port because the port is down or congested.
PortXmitConstraintErrorsExtended	Total number of packets not transmitted from the switch physical port.
PortRcvConstraintErrorsExtended	Total number of packets received on the switch physical port that are discarded.
LocalLinkIntegrityErrorsExtended	The number of times that the count of local physical errors exceeded the threshold specified by LocalPhyErrors
ExcessiveBufferOverrunErrorsExtended	The number of times that OverrunErrors consecutive flow control update periods occurred, each having at least one overrun error
VL15DroppedExtended	Number of incoming VL15 packets dropped due to resource limitations (e.g., lack of buffers) in the port
PortXmitWaitExtended	The time an egress port had data to send but could not send it due to lack of credits or arbitration - in time ticks within the sample-time window
hist[0-4]	Hist[i] give the number of FEC blocks that had RS-FEC symbols errors of value i or range of errors
infiniband_CBW	
Normalized_CBW	
NormalizedXW	
Normalized_XmitData	

The following is a list of available counters which includes a variety of metrics related to timestamps, port and node information, error statistics, firmware versions, temperatures, cable details, power levels, and various other telemetry-related data.

Field Name	Description
timestamp	

Field Name	Description
source_id	
tag	
node_guid	node GUID
port_guid	Port GUID
port_num	Port Number
PortXmitDataExtended	Transmitted data rate per egress port in bytes passing through the port during the sample period
PortRcvDataExtended	The received data on the ingress port in bytes during the sample period
PortXmitPktsExtended	Total number of packets transmitted on the port.
PortRcvPktsExtended	Total number of packets received on the port
SymbolErrorCounterExtended	
LinkErrorRecoveryCounterExtended	
LinkDownedCounterExtended	
PortRcvErrorsExtended	
PortRcvRemotePhysicalErrorsExtended	
PortRcvSwitchRelayErrorsExtended	
PortXmitDiscardsExtended	
PortXmitConstraintErrorsExtended	
PortRcvConstraintErrorsExtended	
LocalLinkIntegrityErrorsExtended	
ExcessiveBufferOverrunErrorsExtended	
VL15DroppedExtended	
PortXmitWaitExtended	
hist[0-4]	Hist[i] give the number of FEC blocks that had RS-FEC symbols errors of value i or range of errors
infiniband_CBW	
Normalized_CBW	
NormalizedXW	
Normalized_XmitData	

8.3 Low-Frequency (Secondary) Telemetry Fields

The following is a list of available counters which includes a variety of metrics related to timestamps, port and node information, error statistics, firmware versions, temperatures, cable details, power levels, and various other telemetry-related data.

Field Name	Description
Node_GUID	node GUID
Device_ID	PCI device ID
node_description	node description
lid	lid
Port_Number	port number
port_label	port label
Phy_Manager_State	FW Phy Manager FSM state
phy_state	physical state
logical_state	Port Logical link state
Link_speed_active	ib link active speed
Link_width_active	ib link active widthsource_id
Active_FEC	Active FEC
Total_Raw_BER	Pre-FEC monitor parameters
Effective_BER	Post FEC monitor parameters
Symbol_BER	BER after all phy correction mechanism: post FEC + PLR monitor parameters
Raw_Errors_Lane_[0-3]	This counter provides information on error bits that were identified on lane X. When FEC is enabled this induction corresponds to corrected errors. In PRBS test mode, indicates the number of PRBS errors on lane X.
Effective_Errors	This counter provides information on error bits that were not corrected by FEC correction algorithm or that FEC is not active.
Symbol_Errors	This counter provides information on error bits that were not corrected by phy correction mechanisms.
Time_since_last_clear_Min	The time passed since the last counters clear event in msec. (physical layer statistical counters)
hist[0-15]	Hist[i] give the number of FEC blocks that had RS-FEC symbols errors of value i or range of errors
FW_Version	Node FW version
Chip_Temp	switch temperature
Link_Down	Perf.PortCounters(LinkDownedCounter)
Link_Down_IB	Total number of times the Port Training state machine has failed the link error recovery process and downed the link.
LinkErrorRecoveryCounter	Total number of times the Port Training state machine has successfully completed the link error recovery process.
PlrRcvCodes	Number of received PLR codewords
PlrRcvCodeErr	The total number of rejected codewords received
PlrRcvUncorrectableCode	The number of uncorrectable codewords received
PlrXmitCodes	Number of transmitted PLR codewords
PlrXmitRetryCodes	The total number of codewords retransmitted

Field Name	Description
PlrXmitRetryEvents	The total number of retransmitted event
PlrSyncEvents	The number of sync events
HiRetransmissionRate	Recieved bandwidth loss due to codes retransmission
PlrXmitRetryCodesWithinTSecMax	The maximum number of retransmitted events in t sec window
link_partner_description	node description of the link partner
link_partner_node_guid	node_guid of the link partner
link_partner_lid	lid of the link partner
link_partner_port_num	port number of the link partner
Cable_PN	Vendor Part Number
Cable_SN	Vendor Serial Number
cable_technology	
cable_type	Cable/module type
cable_vendor	
cable_length	
cable_identifier	
vendor_rev	Vendor revision
cable_fw_version	
rx_power_lane_[0-7]	RX measured power
tx_power_lane_[0-7]	TX measured power
Module_Voltage	Internally measured supply voltage
Module_Temperature	Module temperature
fast_link_up_status	Indicates if fast link-up was performed in the link
time_to_link_up_ext_msec	Time in msec to link up from disable until phy up state. While the phy manager did not reach phy up state the timer will return 0.
Advanced_Status_Opcode	Status opcode: PHY FW indication
Status_Message	ASCII code message
down_blame	Which receiver caused last link down
local_reason_opcode	Opcde of link down reason - local
remote_reason_opcode	Opcde of link down reason - remote
e2e_reason_opcode	see local_reason_opcode for local reason opcode for remote reason opcode: local_reason_opcode+100
PortRcvRemotePhysicalErrors	Total number of packets marked with the EBP delimiter received on the port.
PortRcvErrors	Total number of packets containing an error that were received on the port
PortXmitDiscards	Total number of outbound packets discarded by the port because the port is down or congested.

Field Name	Description
PortRcvSwitchRelayErrors	Total number of packets received on the port that were discarded because they could not be forwarded by the switch relay.
ExcessiveBufferOverrunErrors	The number of times that OverrunErrors consecutive flow control update periods occurred, each having at least one overrun error
LocalLinkIntegrityErrors	The number of times that the count of local physical errors exceeded the threshold specified by LocalPhyErrors
PortRcvConstraintErrors	Total number of packets received on the switch physical port that are discarded.
PortXmitConstraintErrors	Total number of packets not transmitted from the switch physical port.
VL15Dropped	Number of incoming VL15 packets dropped due to resource limitations (e.g., lack of buffers) in the port
PortXmitWait	The time an egress port had data to send but could not send it due to lack of credits or arbitration - in time ticks within the sample-time window
PortXmitDataExtended	Transmitted data rate per egress port in bytes passing through the port during the sample period
PortRcvDataExtended	The received data on the ingress port in bytes during the sample period
PortXmitPktsExtended	Total number of packets transmitted on the port.
PortRcvPktsExtended	Total number of packets received on the port
PortUniCastXmitPkts	Total number of unicast packets transmitted on all VLs from the port. This may include unicast packets with errors, and excludes link packets
PortUniCastRcvPkts	Total number of unicast packets, including unicast packets containing errors, and excluding link packets, received from all VLs on the port.
PortMultiCastXmitPkts	Total number of multicast packets transmitted on all VLs from the port. This may include multicast packets with errors.
PortMultiCastRcvPkts	Total number of multicast packets, including multicast packets containing errors received from all VLs on the port.
SyncHeaderErrorCounter	Count of errored block sync header on one or more lanes
PortSwLifetimeLimitDiscards	Total number of outbound packets discarded by the port because the Switch Lifetime Limit was exceeded. Applies to switches only.
PortSwHOQLifetimeLimitDiscards	Total number of outbound packets discarded by the port because the switch HOQ Lifetime Limit was exceeded. Applies to switches only.
rq_num_wrfe	Responder - number of WR flushed errors
rq_num_lle	Responder - number of local length errors
sq_num_wrfe	Requester - number of WR flushed errors
Temp_flags	Latched temperature flags of module
Vcc_flags	Latched VCC flags of module

Field Name	Description
device_hw_rev	Node HW Revision
sw_revision	switch revision
sw_serial_number	switch serial number
measured_freq_[0-1]	Clock frequency measurement in last 100msec
min_freq_[0-1]	Minutes of clock frequency measured. Units of 0.1 KHz
max_freq_[0-1]	Max of clock frequency measured. Units of 0.1 KHz
max_delta_freq_[0-1]	Observed max delta frequency in window of 100msec. Units of 0.1 KHz
snr_media_lane_[0-7]	SNR value on the media lane <i>. In unit scale of 1/256 dB. The SNR value represents the electrical signal-to-noise ratio on an optical lane, and is defined as the minimum of the three individual eye SNR values.
snr_host_lane_[0-7]	SNR value on the host lane <i>. In unit scale of 1/256 dB. The SNR value represents the electrical signal-to-noise ratio on an optical lane, and is defined as the minimum of the three individual eye SNR values.
tx_cdr_lol	Bitmask for latched Tx cdr loss of lock flag per lane.
rx_cdr_lol	Bitmask for latched Rx cdr loss of lock flag per lane.
tx_los	Bitmask for latched Tx loss of signal flag per lane.
rx_los	Bitmask for latched Rx loss of signal flag per lane.
phy_received_bits	This counter provides information on the total amount of traffic (bits) received
rq_general_error	The total number of packets that were dropped since it contained errors. Reasons for this include: Dropped due to MPR mismatch.

9 UFM Web UI

This section is constituted by the following sub-sections:

- [Fabric Dashboard](#)
- [Network Map](#)
- [Managed Elements](#)
- [Events & Alarms](#)
- [Telemetry - User-Defined Sessions](#)
- [System Health](#)
- [Jobs](#)
- [Settings](#)

9.1 Fabric Dashboard

The dashboard window summarizes the fabric's status, including events, alarms, errors, traffic and statistics.

Fabric Dashboard View

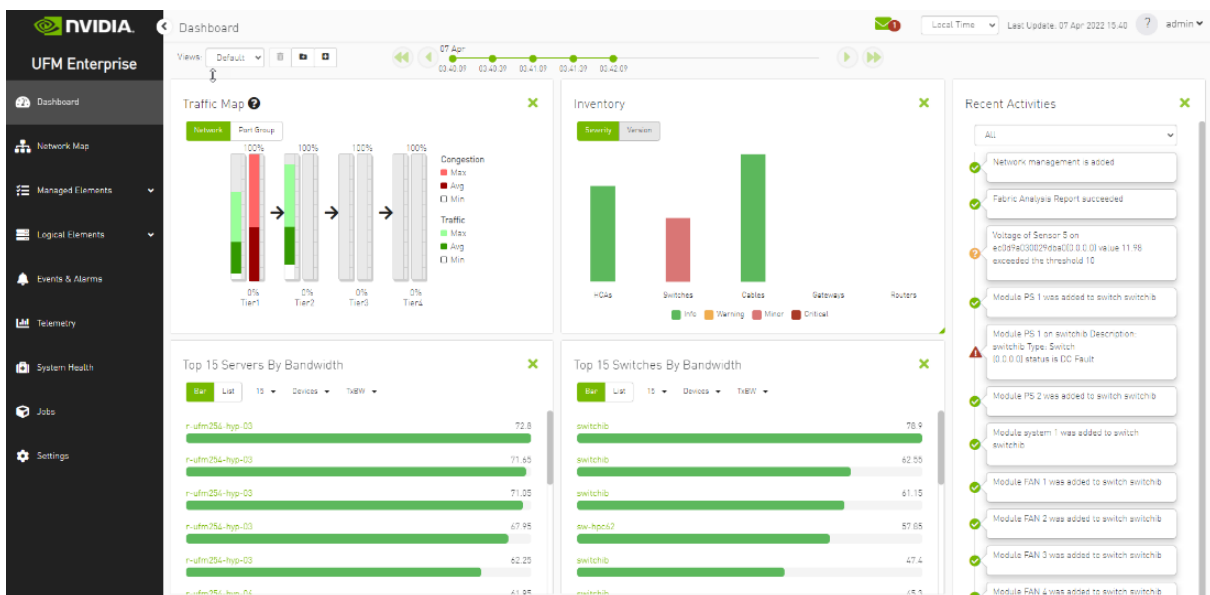

The Fabric Dashboard view consists of the following six dashboards, which provide real-time information about the fabric.

9.1.1 Dashboard Views and Panel Management

UFM is installed with a default view of the most important panels. These panels are resizable and draggable. Users can customize their default view or create new views altogether

The dashboard views and panels are managed by a set of action buttons appearing at the top of the main dashboard screen:

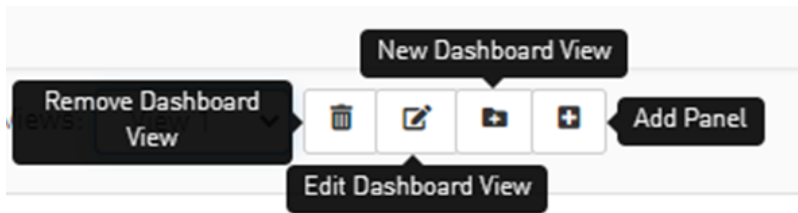

Clicking on the Add Panel button will show a model to select which panels you wish to add to the current dashboard view.

New Panels

- All 12
- Health 2
- Monitoring 7
- Events and Alarms 3

Inventory

Severity Version

Hubs Switches Cables Gateways Routers

Info Warning Minor Critical

Fabric Health

Switches Routers Servers Servers

Critical: 1 Minor: 0 Normal: 2 Warning: 0

Critical: 0 Minor: 0 Normal: 7 Warning: 0

Traffic Map

Network Port Group

Congestion: Max, Avg, Min

Traffic: Max, Avg, Min

Levels Traffic Map

Network App Group

Congestion: Max, Avg, Min

Traffic: Max, Avg, Min

Top 5 Servers By Bandwidth

Bar List 5 Servers TdBW

ufm-host87	23.184
nuM254-isp-03	22.576
nuM254-isp-04	19.456

Top 10 Switches By Bandwidth

Bar List 10 TdBW

sw-isp02	183.16
sw-isp02	145.2
switch0b	39.582

Top 5 Congested Servers

Bar List 5 TdBW

nuM254-isp-03	4540
nuM254-isp-04	3547
ufm-host87	1640

Top 5 Congested Switches

Bar List 5 TdBW

switch_07	89
switch0b	84
sw-isp02	4

2 Panels Selected

Add Panels Cancel

9.1.2 Dashboard Timeline Snapshots

Once the user is logged into the UFM Enterprise, the UFM will start recording snapshots of the dashboard panel data every 30 seconds.

The user is able to navigate between these snapshots and load the dashboard data of a specific data snapshot.

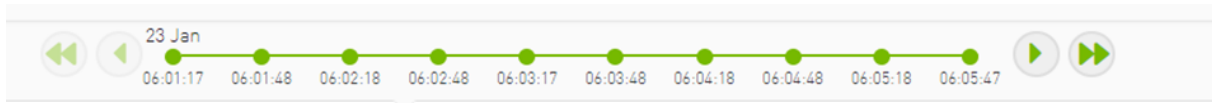

9.1.3 Dashboard Panels

The Fabric Dashboard view consists of the following 12 panels, which are categorized into 3 main categories and provide real-time information about the fabric.

- Health:
 - Inventory
 - Fabric Health
- Monitoring:
 - Traffic Map
 - Levels Traffic Map
 - Top X Servers by bandwidth
 - Top X Switches by bandwidth
 - Top X congested servers
 - Top X congested switches
 - Top X utilized Pkeys
- Events and Alarms:
 - Recent Activities
 - Top X alarmed servers
 - Top X alarmed switches
 - Events History

9.1.4 Top N Servers/Switches by Rx or Tx Bandwidth

The Top N servers/switches by Rx or Tx Bandwidth component shows the top elements that are transmitting or receiving the most bandwidth per second. These elements are classified top-down according the defined Transmit (Tx) or Receive (Rx) bandwidth (MB/sec Rate).



Bandwidth is measured as a rate in bytes/sec.

- Transmitted (Tx) bandwidth is measured by N server/switch ports in MB/sec
- Received (Rx) bandwidth is measured by N server/switch ports in MB/sec

N can be 5, 10, 15, or 20.

The following table lists the icons of this component:

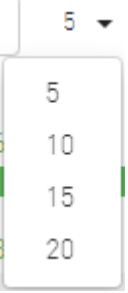
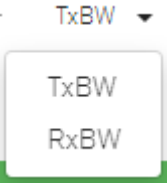
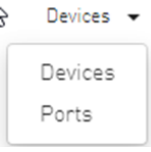
Options	Description
List view <input type="radio"/> Bar <input checked="" type="radio"/> List	Shows the top N elements as a list Each element is shown in a row with the name of the element and the bandwidth rate

Options	Description
<p>Bar view</p> 	<p>Shows the top N nodes as a bar graph</p> <ul style="list-style-type: none"> • X axis shows the rate as a value • Y axis shows the Node (server) name
<p>Drop-down menu</p> 	<p>Selects the number of items to display Default: 10 nodes</p>
<p>Monitoring attributes</p> 	<p>Selects the attribute for monitoring:</p> <ul style="list-style-type: none"> • TxBW - Transmit Bandwidth • RxBW - Receive Bandwidth
<p>View by port/element</p> 	<p>Switches view to top 5 elements by bandwidth or top 5 ports by bandwidth. Nodes view is presented by default.</p> <ul style="list-style-type: none"> • Clicking a specific port in the ports view under the port column redirects to the ports table and highlights that particular port • Clicking a specific device in the devices view under the device column redirects to the Devices table and highlights that particular node
<p>Filter toggle</p> 	<p>Toggles the filter textbox</p>

Top Servers/Switches by Bandwidth—Bar View

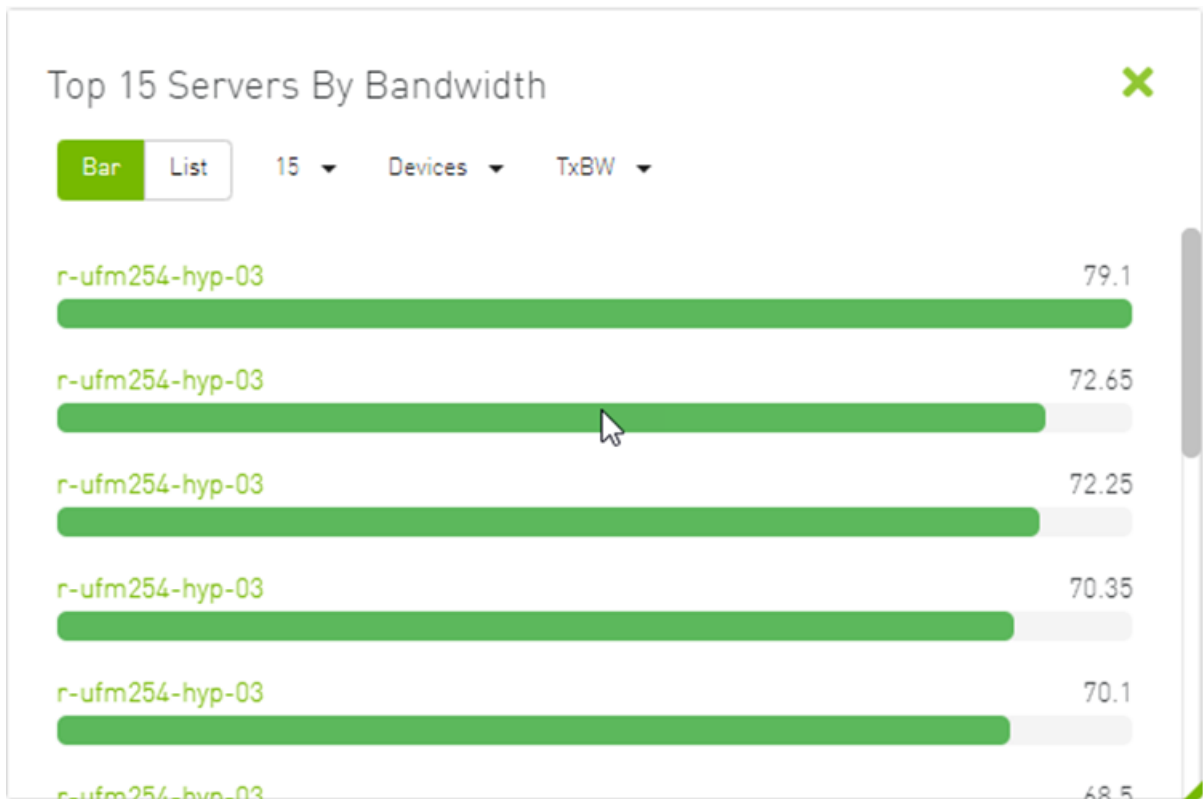

Top Servers/Switches by Bandwidth—List View

Top 15 Servers By Bandwidth ✕

15 ▾ Devices ▾ TxBW ▾

5 ▾

Device	TxBW BandWidth (Gbps) ↓
r-ufm254-hyp-04	75.35
r-ufm254-09	74.6
r-ufm254-011	65.95
r-ufm254-04	64.7
r-ufm254-012	63.2

1 to 5 of 15 |< < Page 1 of 3 > >|

Right-clicking a device displays a list of the actions that can be performed. These actions (shown in the following screenshot) are the same actions available in the devices table (see [Devices Actions](#) table under [Devices Window](#)).

Top 15 Servers By Bandwidth ✕

15 ▾ Devices ▾ TxBW ▾

5 ▾

Device	TxBW BandWidth (Gbps)
r-ufm254-hyp-03	38.8
r-ufm254-hy	40.1
ufm-host87	79.05
r-ufm254-01	47.6
r-ufm254-02	72.8

- Mark As Unhealthy ▶
- Firmware Upgrade
- Add To Group ▶
- Remove From Group ▶
- Suppress Notifications
- Add To Monitor Session

o 5 of 15 |< < Page 1 of 3 > >|

Right-clicking a port displays a list of the actions that can be performed. These actions (shown in the following screenshot) are the same actions available in the Ports table (see [Ports Window](#) for more information).

The screenshot shows a window titled "Top 15 Servers By Bandwidth" with a close button (X) in the top right. Below the title, there are controls for view type (Bar/List), count (15), sort criteria (Ports/TxBW), and a refresh button (5). The main area is a table with two columns: "Port" and "TxBW BandWidth (Gbps)". A context menu is open over the first row, listing actions: "Go To Peer", "Reset", "Mark As Unhealthy", and "Disable". At the bottom, there is a pagination control showing "1 to 5 of 15" and "Page 1 of 3".

Port	TxBW BandWidth (Gbps)
r-ufm254-hyp-03 HCA-1 (port #11)	13.85
r-ufm254-hyp-0	77.6
ufm-host87 HCA	52.95
r-ufm254-01	34.8
r-ufm254-02	65.95

9.1.5 Top N Congested Servers/Switches by Rx/Tx Bandwidth

The Top N Congested devices by Rx or Tx Bandwidth component shows the top congested devices, classified top-down according to the defined Transmit (Tx) or Receive (Rx) bandwidth.

Bandwidth is measured as congestion bandwidth rate (CBW) by percentage.

- For Tx, congestion is measured by N HCA ports.
- For Rx, congestion is measured by N switch ports connected to HCAs.

N can be 5, 10, 15, or 20.

Top N Congested Servers by Bandwidth—List View

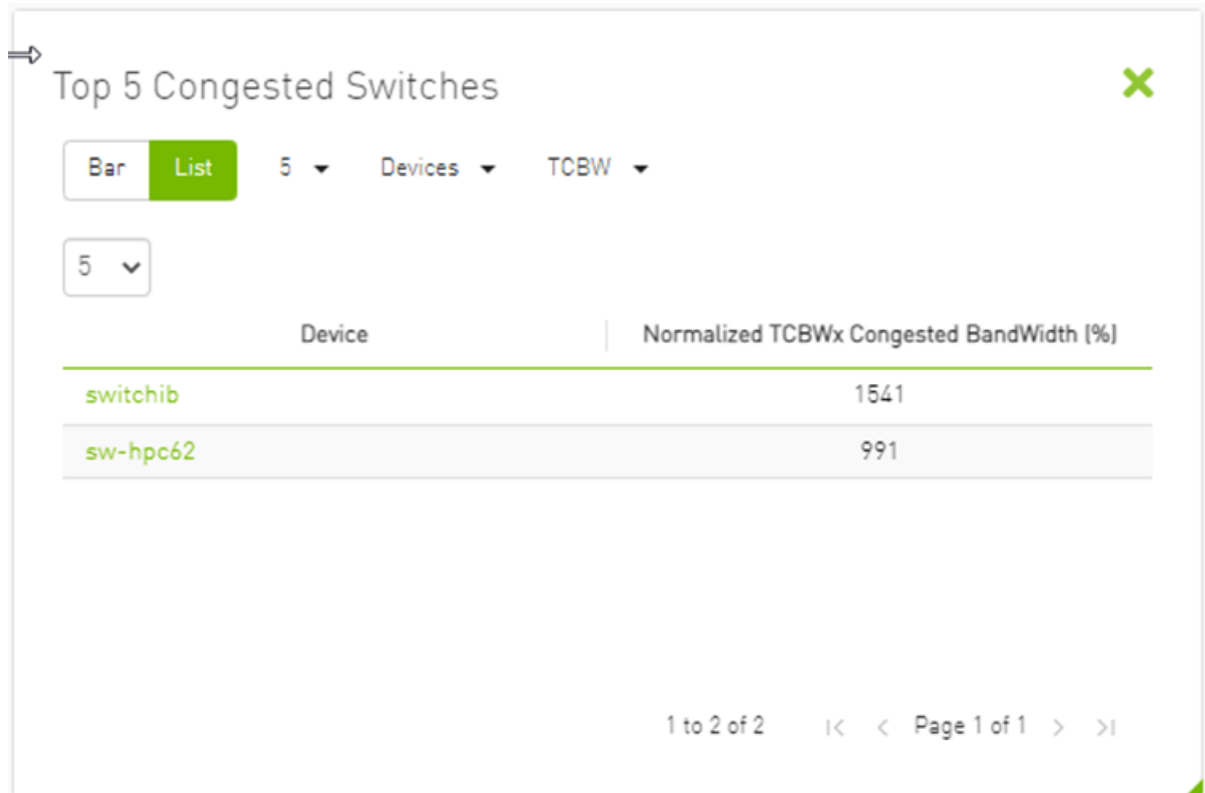
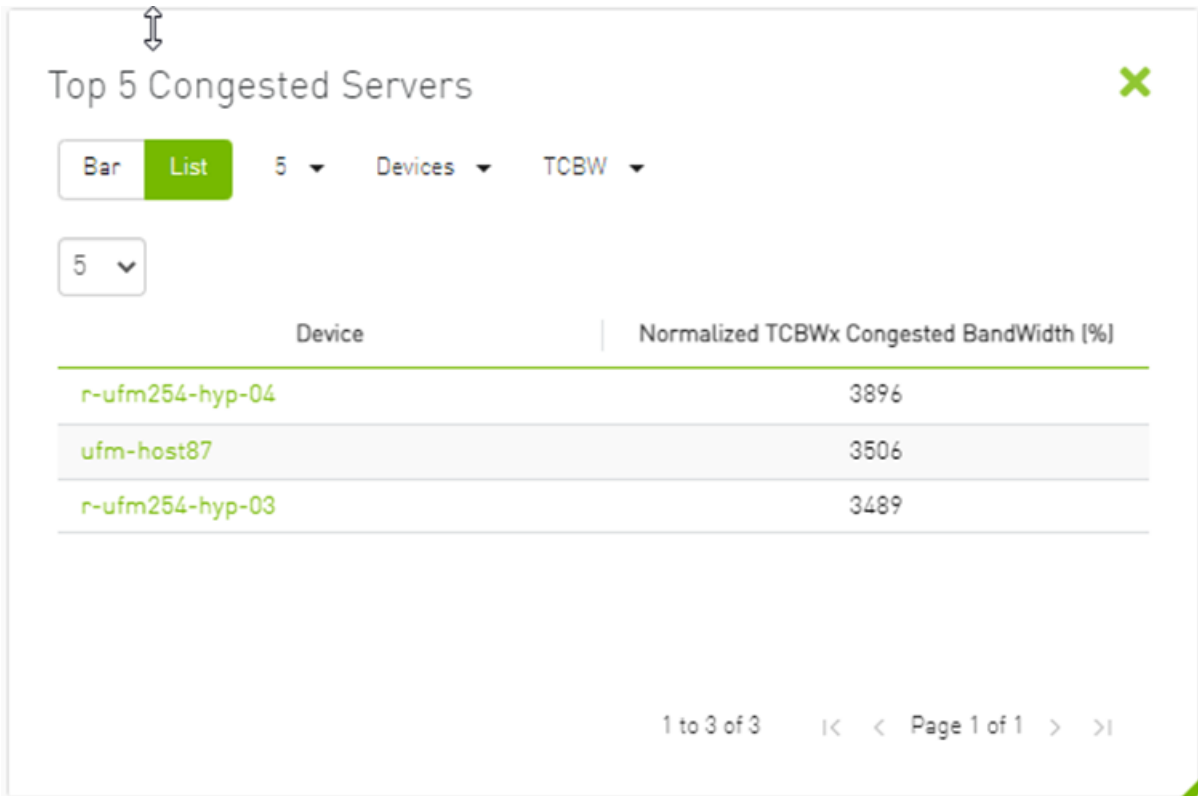

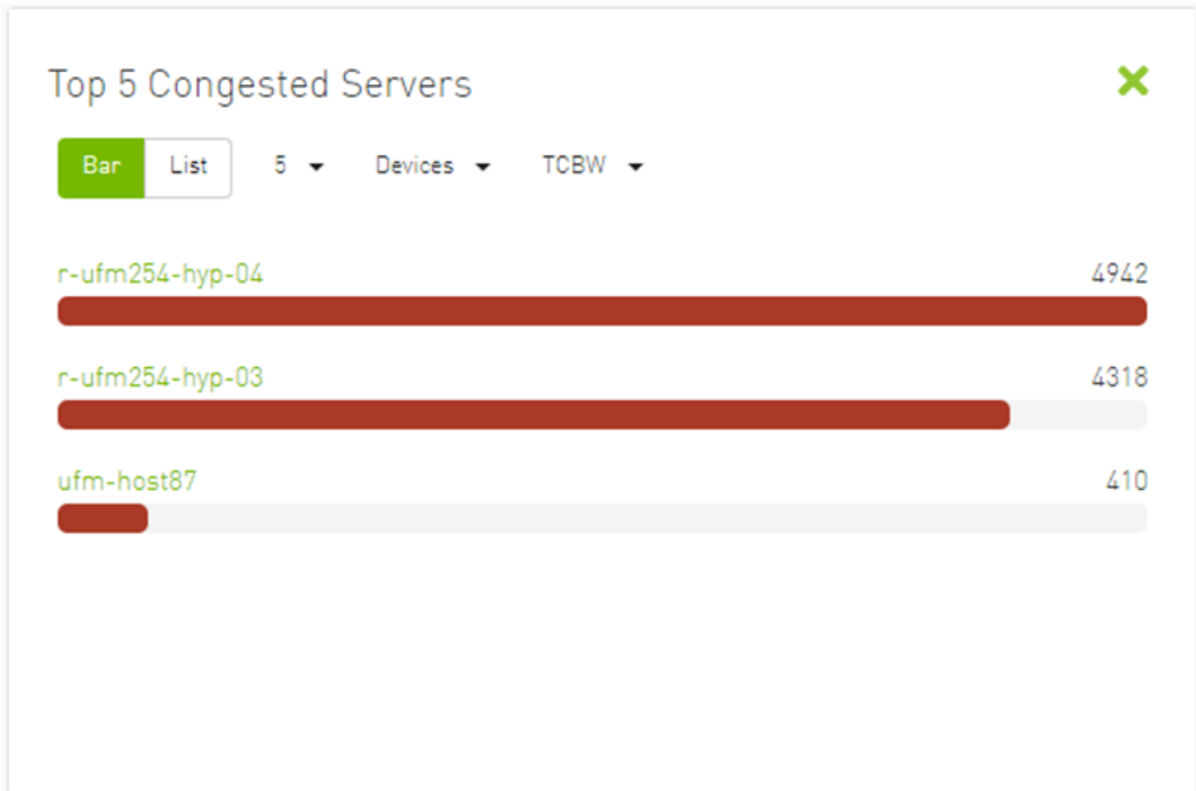

Top N Congested Servers/Switches by Bandwidth—Bar View



The following table describes the options available in this component.

Top N Congested Devices by Rx/Tx Bandwidth

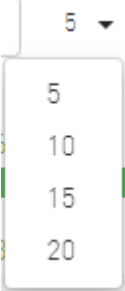
Options	Description
Bar view 	Shows the top N congested devices as a bar graph <ul style="list-style-type: none"> • X axis shows the rate as a percentage • Y axis shows the congested Node (server) name
List view 	Shows the top N congested nodes as a list Each congested node is shown in a row with the name of the node and its picture. It also shows the bandwidth rate
Drop-down menu 	Enables selecting the number of top N congested nodes Default: 10 nodes

Options	Description
<p>View by port/element</p> <p>› Devices ▾</p> <div style="border: 1px solid #ccc; padding: 5px; width: fit-content;"> <p>Devices</p> <p>Ports</p> </div>	<p>Switches view to Top 5 elements By Bandwidth or Top 5 Ports By Bandwidth. Devices view is presented by default.</p> <ul style="list-style-type: none"> Clicking a specific port in the Ports view under the Port column redirects to the Ports table and highlights that particular port Clicking a specific device in the Nodes view under the Device column redirects to the Devices table and highlights that particular node
<p>Monitoring attributes</p> <p>· TxBW ▾</p> <div style="border: 1px solid #ccc; padding: 5px; width: fit-content;"> <p>TxBW</p> <p>RxBW</p> </div>	<ul style="list-style-type: none"> RCBW - Receive Congested Bandwidth (percentage) TCBW - Transmit Congested Bandwidth (percentage)

9.1.6 Top N Utilized PKeys

Top N Utilized PKeys displays the top utilized PKeys based on the number of the PKey members.

N can be 5, 10, 15, or 20.

Top N Utilized PKeys—List View

Top 5 Utilized PKeys

Bar
List
5 ▾

5 ▾
🔍

Pkey	# of GUIDs
0x22	3
0x23	2
0x77	1
0x7fff	0

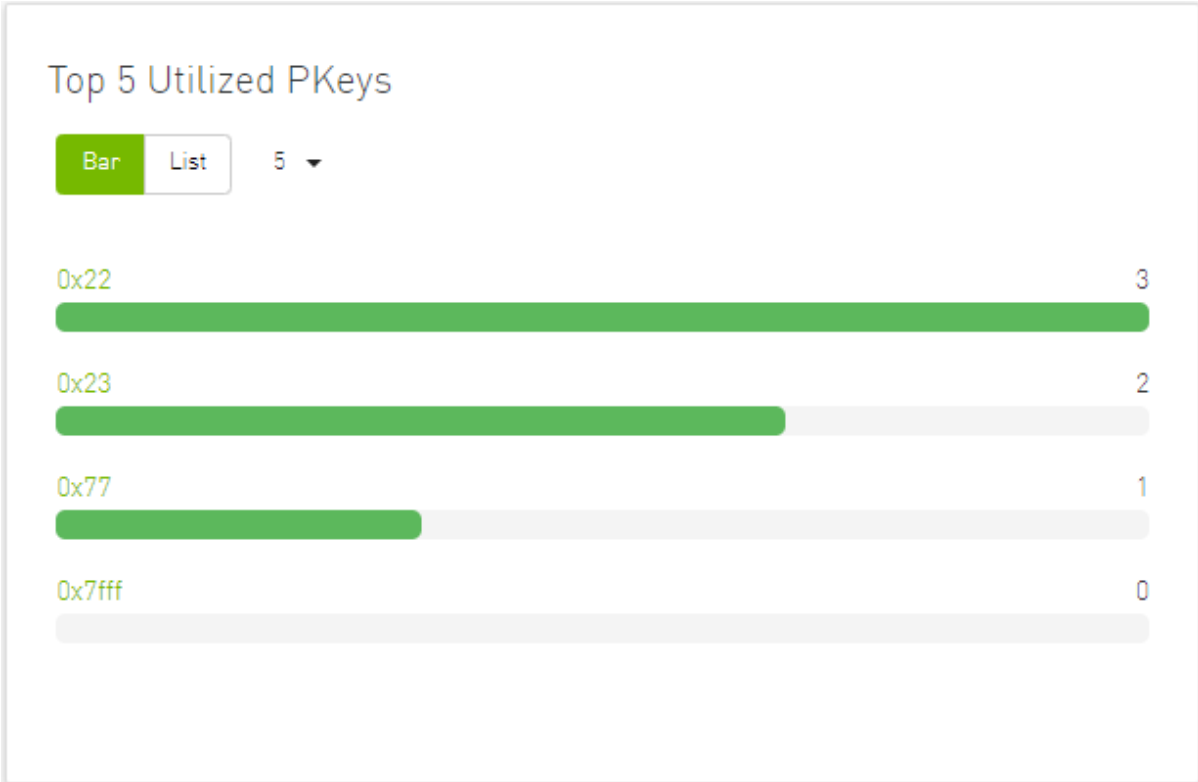

1 to 4 of 4
|<
<
Page 1 of 1
>
>|

Top N Utilized PKeys—Bar View

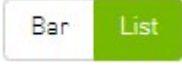

The following table describes the options available in this component.

Top N Utilized PKeys

Options	Description
Bar view 	Shows the top N Utilized PKeys as a bar graph <ul style="list-style-type: none"> • X axis shows the number of members • Y axis shows the names of the PKeys
List view 	Shows the top N Utilized PKeys as a list Each PKey is shown in a row with the name of the PKey and the number of its members
Drop-down menu 	Enables selecting the number of top N Utilized PKeys Default: 10 Utilized PKeys





9.1.7 Top N Alarmed Servers/Switches

The Top N Alarmed Servers/Switches component shows the top nodes with alarms classified in a descending order. Alarmed nodes are measured according to the following:

- Severity - only the top nodes, in order of severity:
 - Critical
 - Minor
 - Warning
 - Normal
- Alarm - numbers (N can be 5, 10, 15, or 20)

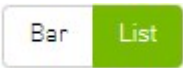
The following table lists the components.

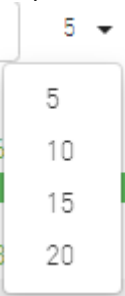
Top N Alarmed Servers/Switches

Options	Description
List view 	Shows the top N alarmed servers/switches as a list. Each alarmed device is shown in a row with the name of the node and the number of alarms.
Bar view 	Shows the top N alarmed devices as a bar graph. <ul style="list-style-type: none"> • X axis shows the number of alarms • Y axis shows the names of the alarmed nodes (servers)
Drop down menu 	Enables selecting the number of top N alarmed nodes. Selects the number of items to display. Default: 10 alarmed nodes
Filter toggle 	Toggles the Filter textbox

Top Alarmed Servers/Switches—List View

Top 5 Alarmed Servers ✕

5 ▾

▾

Device	Alarms
r-ufm254-hyp-03	9
r-ufm254-hyp-04	9
ufm-host87	7

1 to 3 of 3 ⏪ < Page 1 of 1 > ⏩

Top 5 Alarmed Switches ✕

5 ▾

▾

Device	Alarms
sw-hpc62	9
switchib	8

1 to 2 of 2 ⏪ < Page 1 of 1 > ⏩

Top N Alarmed Servers/Switches—Bar View

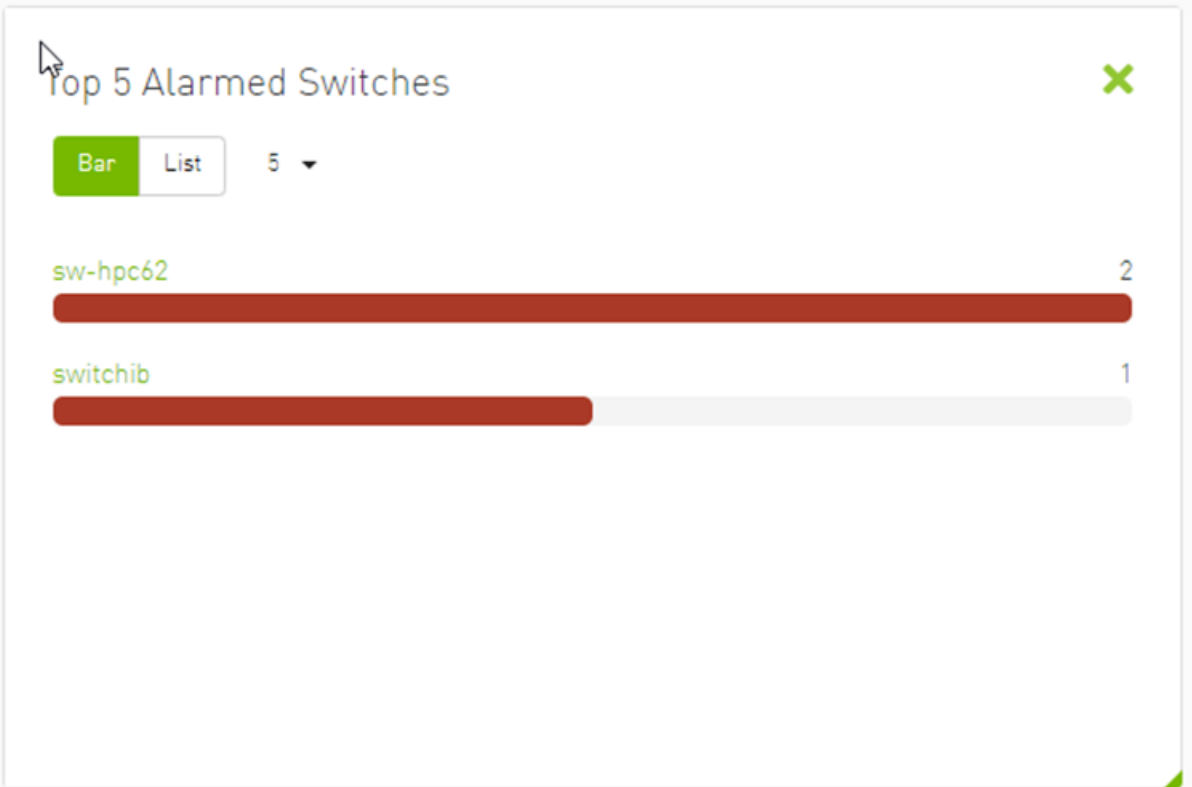
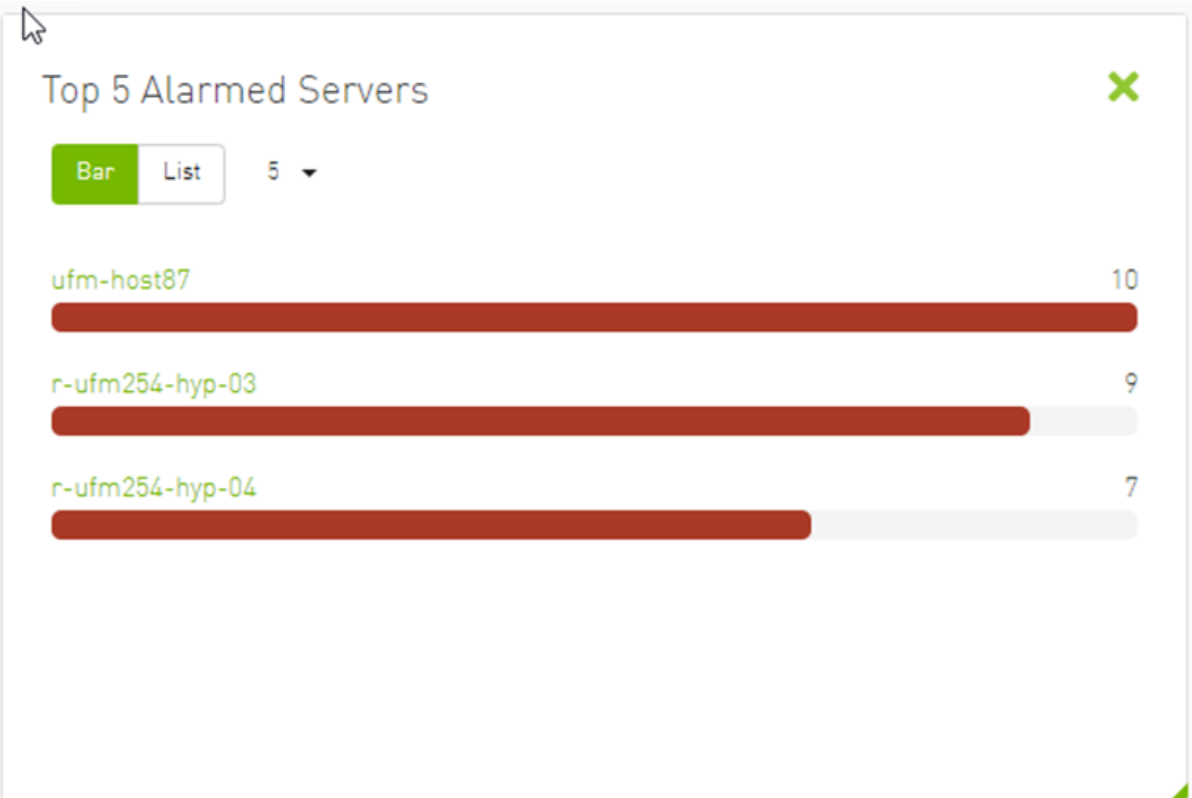

9.1.8 Inventory Summary

The Fabric Inventory Summary component shows a summary of your fabric inventory (HCAs, Switches, Gateways, Routers and Cables) categorized by the element's severity or firmware version.

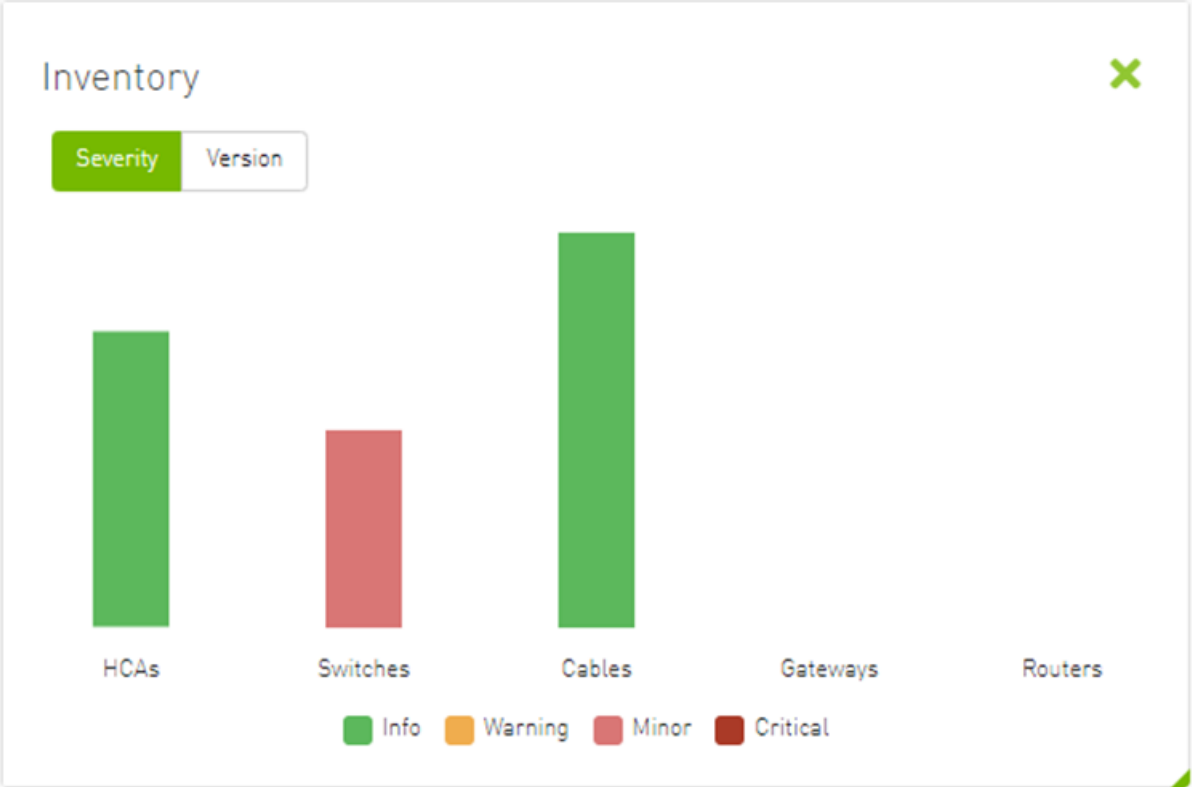

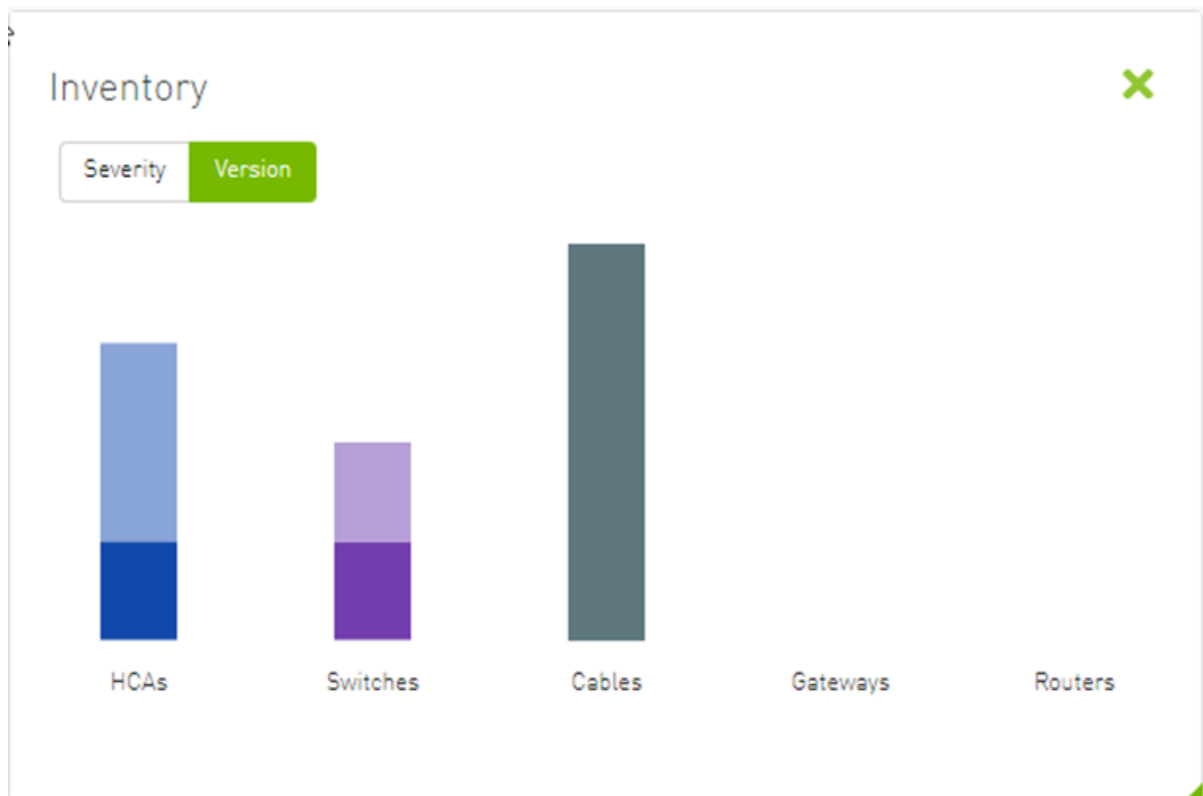

Clicking on one bar element with specific severity/firmware version will redirect you to the clicked element's table.

9.1.9 Fabric Utilization

The Fabric Utilization component shows the number of alarmed objects, categorized by the alarm's severity. They are as follows:

1. Warning
2. Minor
3. Normal
4. Critical

If Server X has 2 minor alarms, 1 warning alarm and 2 critical alarms, and Server Y has 0 minor alarms, 2 warning alarms and 1 critical alarm, the Fabric Resource Utilization pie chart will show 2 servers in the critical slice, 2 servers in the warning slice and 1 server in the minor slice.

You can filter for both switches and nodes of a specific severity level by clicking the specific pie slice indicating the severity.

In the example below, the Devices table lists all the switches of severity level "Minor" after clicking the red (Minor) slice from the Switches pie chart.



Devices Local Time Last Update: 07 Apr 2022 17:01 admin

Showing 2 out of 5. Click to reset all filters

Severity	Name	GUID	Type	Model	IP	Firmware Version
Minor	sw-p0c02	0-7d4e400300a5a2e0	switch	M5B7600	N/A	15.1000.102
Minor	switch-9	0res0e7e03002768e0	switch	EDR	N/A	19.2009.1029

Viewing 1-2 of 2

9.1.10 Recent Activities

The Recent Activities component lists the recent events detected by the UFM system.

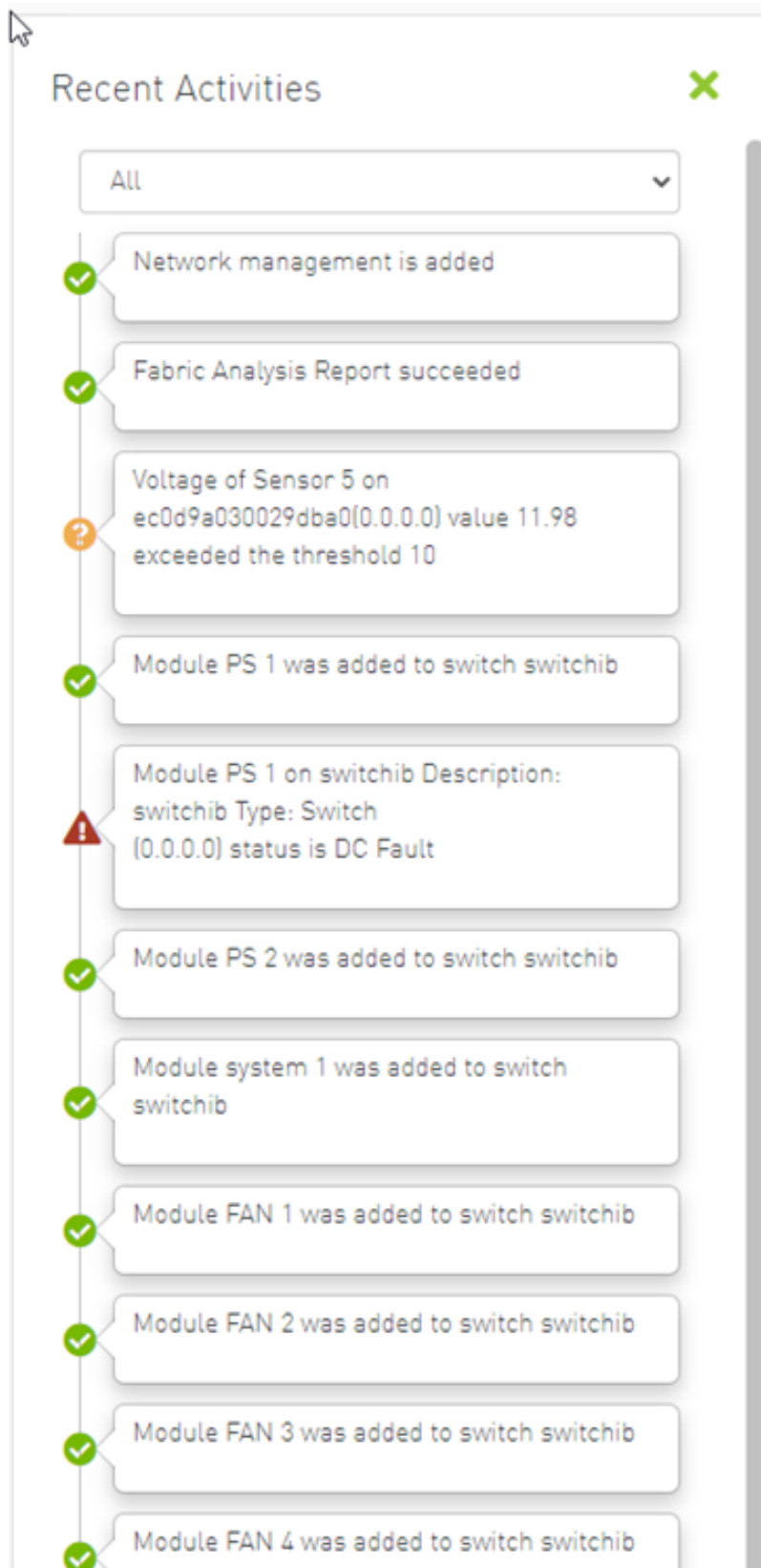

You can filter for the events you would like to see in one list using the drop-down menu that provides the following options:

- All - shows all recent activities
- All issues - shows all non-Info activities
- Info - shows all activities with Info severity or higher
- Minor - shows you all activities with Minor severity or higher
- Warning - shows you all activities with Warning severity or higher
- Critical - shows you all activities with Critical severity

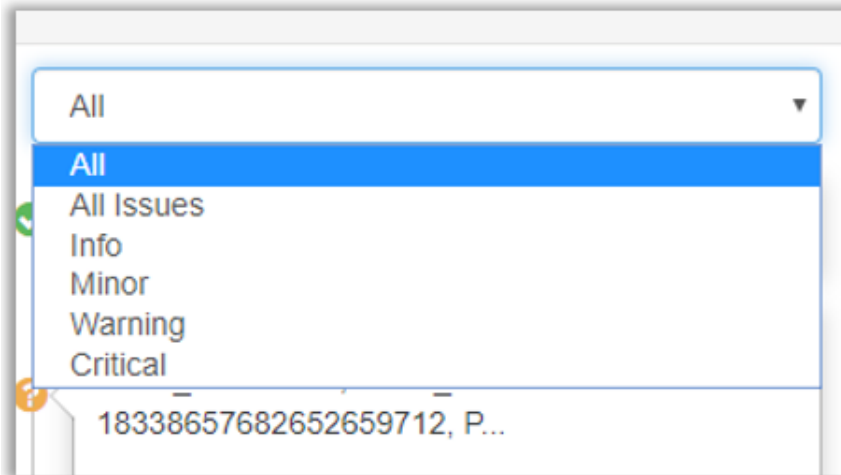



9.1.11 Traffic Map

The Traffic Map dashboard shows the normal traffic versus congested traffic distributed on switch tiers and on port groups. This view, together with the Top N Congestion dashboard, gives a full status of the traffic congestion of the fabric.

9.1.11.1 Network Traffic Map

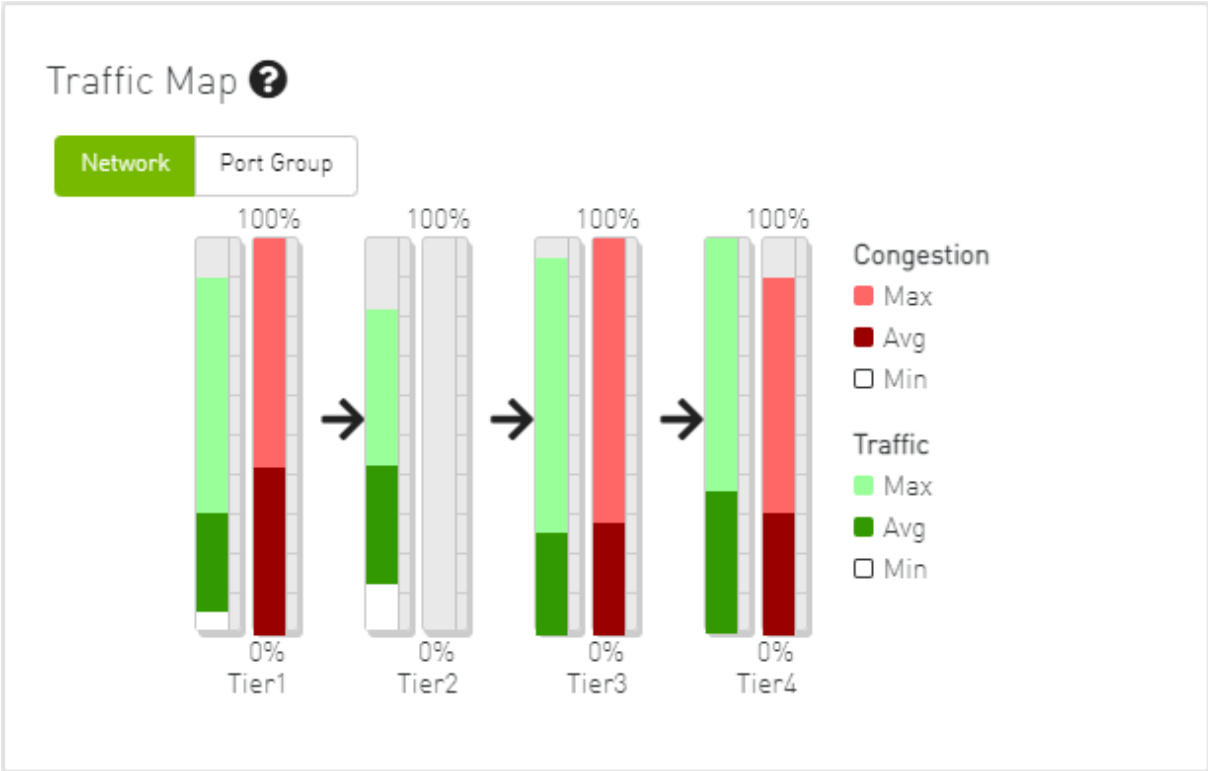
Four double bars represent the transmitted bandwidth (normalized transmit data) and normalized congested bandwidth (CBW), both measured in bytes/sec with minimum, average, and maximum bandwidth values.



An explanatory window on traffic map opens once clicked on the  icon.

Traffic Map Guide

Mellanox's unique Traffic Map provides a valuable real-time aggregate view of the fabric performance by showing the overall bandwidth utilization per switching tier coupled with congestion information.

Reading the Traffic Map Chart

The Traffic Map contains four tiers; each tier is represented by a green and a red bar, as shown in the following Traffic Map Chart :

The chart displays four tiers, each with a green bar (Transmitted Bandwidth) and a red bar (Congestion/Delay, Lost Bandwidth). The green bar is divided into three segments: Max (light green), Avg (dark green), and Min (white). The red bar is also divided into three segments: Max (light red), Avg (dark red), and Min (white). The vertical axis represents percentage utilization, with 0% at the bottom and 100% at the top. The horizontal axis represents the tiers. Tier 1 is labeled 'Traffic sent by the adapters', Tier 2 is 'Traffic sent from edge to core switch', Tier 3 is 'Traffic sent from core to edge switch', and Tier 4 is 'Traffic received by the adapters'. Tier 3 is marked as 'DOWN'.

Color coding for each tier is as follows:

- The green the percentage of overall bandwidth generated by the specific tier. This bar is divided in light and dark green colors.
 - The light green indicates the peak port utilization.
 - The dark green indicates the average utilization.
- The red bar indicates the percentage of congestion (also referred to as lost bandwidth) in the specific tier. This bar is divided in red and dark red colors.
 - Red indicates the peak port congestion.
 - Dark red indicates the average congestion.

Close

The percentage of total theoretical bandwidth (TBW) is calculated based on the underlying InfiniBand technology (SDR, DDR, QDR, FDR or EDR). The speed can be viewed when checking the ports.

- The vertical axis shows the following:
 - Bandwidth (BW) is represented by a green bar and is measured in percentages
 - Congested Bandwidth (CBW) is represented by a red bar and is measured in percentages
 - Minimum, average, and maximum bandwidth are represented in each bar by a subset color
- The horizontal axis represents the tiers.

The bottom of the dashboard represents the tier-related transmitted traffic, which is divided into four segments by measurement ports:

 - Tier 1 - represents the traffic injected by all adapters
 - Tier 2 - represents the traffic sent from the edge switches to the core of the fabric (in case of a single Director switch, this tier indicates traffic utilization inside the Director between the line and fabric boards)

- Tier 3 - represents the traffic sent from the core to the edge switches
- Tier 4 - represents the traffic sent from the edge switch to the adapters

The illustrations at the bottom of the tiers show a four-tier topology:
Server [tier 1] Switch [tier 2] Director Switch [tier 3] Switch [tier 4] Server.

9.1.11.2 Levels Network Traffic Map

Different representation of the fabric traffic map that based on the devices/ports levels.



The level of the device/port is the distance between the device and the nearest server/gateway.

Levels Calculations:

- The levels calculations are configurable from the `gv.cfg` file under TopologyLevels section enable item and it is disabled by default.
- The levels names are configurable from the `gv.cfg` file under TopologyLevels section levels item and by default we are defining up to 4 levels levels equals server, leaf, spine, core

- Server: hosts and gateways.
- Leaf: switches and routers that are directly connected to the server
- Spine: switches and routers that are directly connected to the leaf
- Core: switches and routers that are directly connected to the spine

If the fabric has more than 4 levels, the level value will be L + distance e.g., L4, L5, L(N), and if levels was empty, the levels will start from L0, L1, L2, etc.

The levels calculations are done at either the discovery stage or once the topology changes.

Ports Tiers calculations based on the levels:

If the levels calculations is enabled, the port's tier will be calculated as the following steps:

1. Get the level for both port's parent device and port's peer parent device
2. Decide whether the port's data flow is the up or down direction, by checking the order of the parent and peer parent level:
 - a. If the parent's level order is less than or equals the parent peer level, then the port's flow is up and tier is the parent level order
 - b. If the port's flow is down and the tier is the distance between the host to the root device and the distance between the root to the parent device

Example:

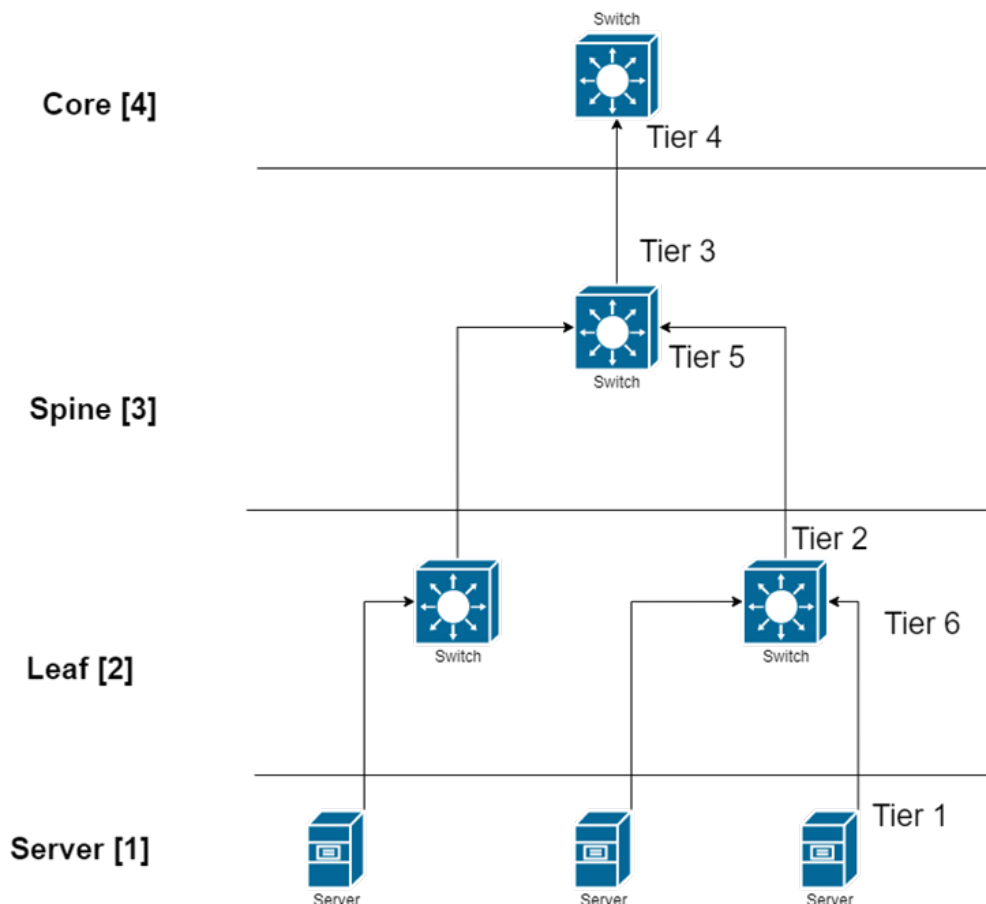

If the level calculations are disabled, the tier calculations will be done as mentioned in this section.

9.1.11.3 Port Group Traffic Map

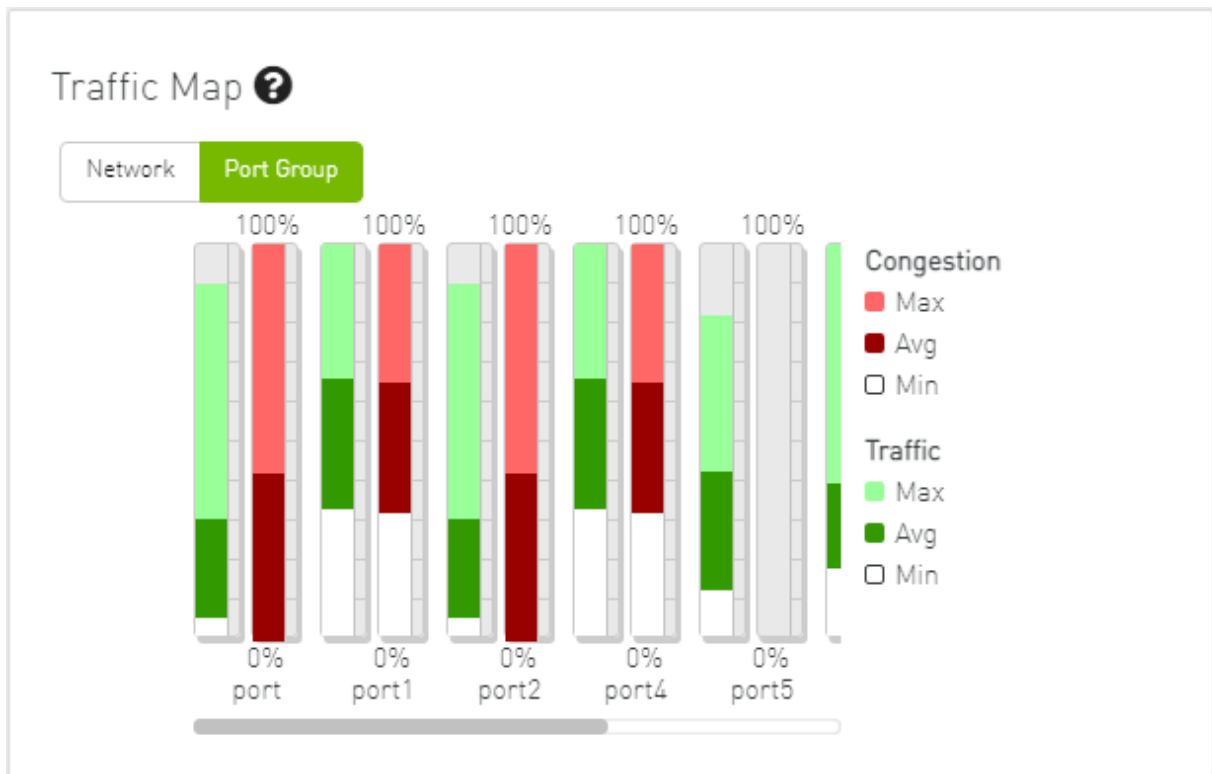

9.1.11.4 Traffic Map Bar Chart

- Bandwidth Bars

The bandwidth graph shows how traffic is traversing the fabric and how traffic is being transmitted between the servers. For example, the following considerations could be evaluated:

- The size of the difference between max bandwidth and min bandwidth.
- The traffic that is flowing in the middle tiers and whether it would be more efficient to move the traffic to the edges to save the uplinks.

Bandwidth levels are measured in percentages, as shown below:

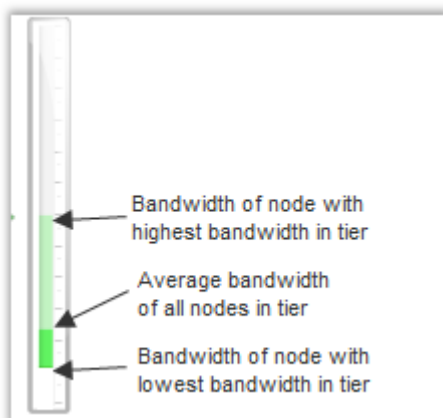

- Congestion Bars

The Congestion graph shows where congestion starts. For example, the following considerations could be evaluated:

- If congestion is in the first or second tier, there is probably a routing problem
- If there is no red bar, it means that there is no congestion or no routing problems

Congestion levels are measured in percentages, as shown:

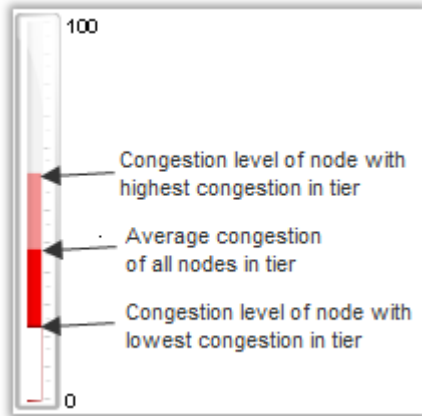

9.1.12 Events History

To view the Event History panel in the dashboard, the System Monitoring feature must be enabled. Otherwise, the panel will be hidden. Users can enable System Monitoring by setting the `system_monitoring_metrics` flag under the `SystemMonitoring` section in the `gv.cfg` file to true.

The Events History panel presents the topology change events in a table along with their respective counts.

The screenshot shows a web interface for 'Events History'. At the top left, there is a dropdown menu set to '5'. At the top right, there is a dropdown menu set to 'Last 5 Minutes'. Below these is a table with two columns: 'Name' and 'Count'. The table contains five rows of data. At the bottom right, there is a pagination control showing '1 to 5 of 8' and 'Page 1 of 2'.

Name	Count
Link is Down	1
Link is Up	8
Node is Down	1
Node is Up	4
Switch is Down	1

The user can filter the event count by selecting the desired time interval.

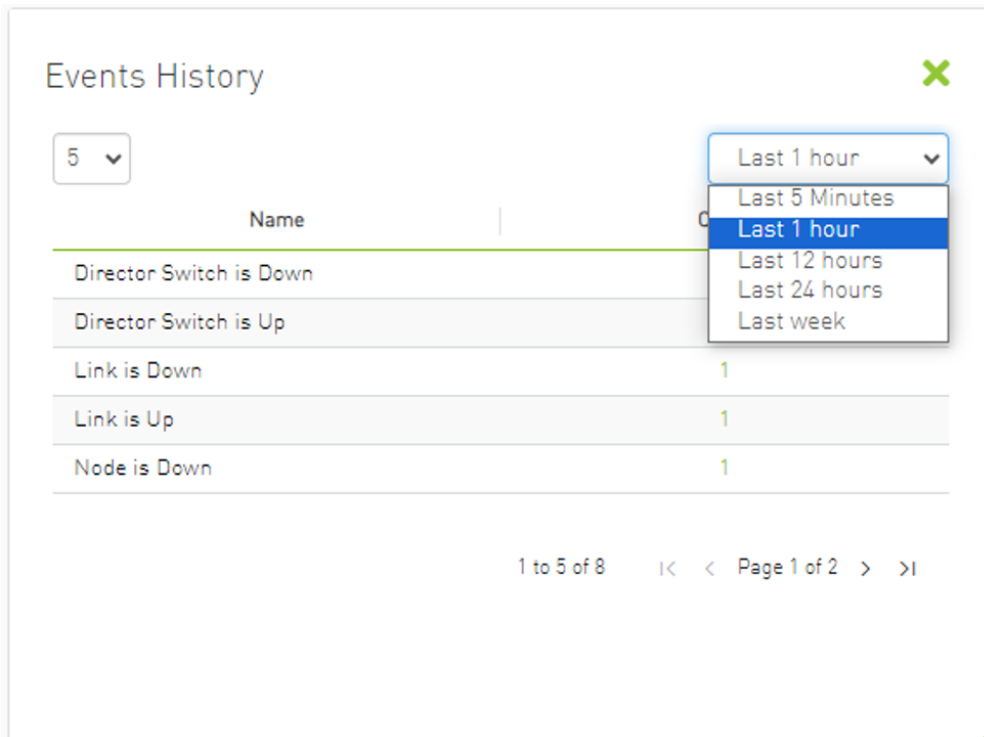

The screenshot shows the 'Events History' window with a dropdown menu open for selecting a time interval. The menu options are: Last 1 hour (selected), Last 5 Minutes, Last 12 hours, Last 24 hours, and Last week. The table below shows event counts for various categories.

Name	Count
Director Switch is Down	
Director Switch is Up	
Link is Down	1
Link is Up	1
Node is Down	1

1 to 5 of 8 |< < Page 1 of 2 > >|

Users can navigate to the 'Device/Link Status Events' tabs by either clicking on the counter value or by right-clicking and selecting 'Go to Events History'.

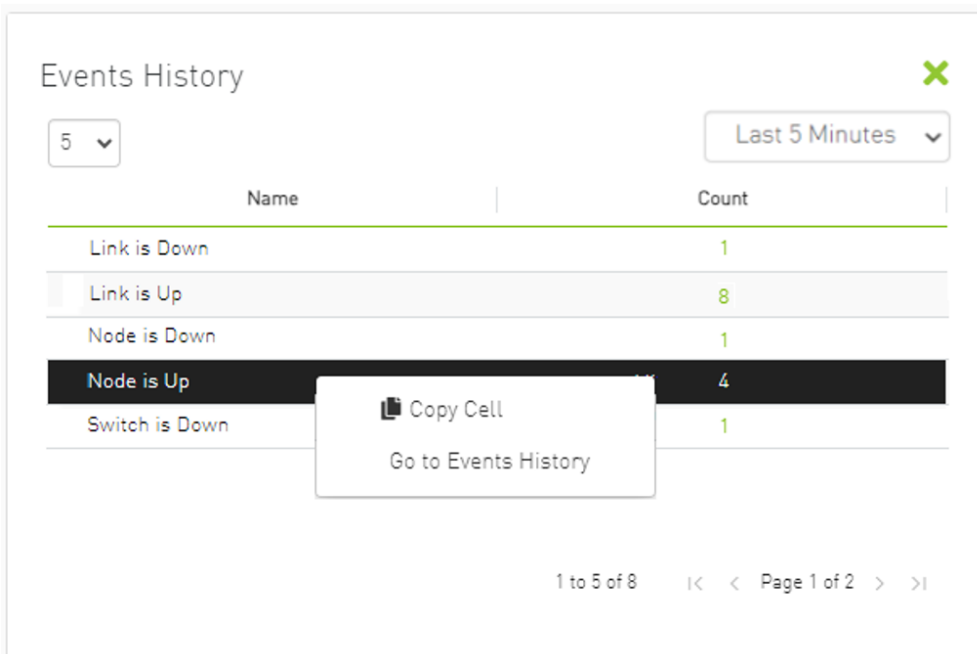

The screenshot shows the 'Events History' window with a right-click context menu open over the 'Node is Up' row. The menu options are: Copy Cell and Go to Events History. The table below shows event counts for various categories.

Name	Count
Link is Down	1
Link is Up	8
Node is Down	1
Node is Up	4
Switch is Down	1

1 to 5 of 8 |< < Page 1 of 2 > >|

9.2 Network Map

The Network Map window shows the fabric, its topology, elements and properties. UFM performs automatic fabric discovery and displays the fabric elements and their connectivity. In the Network Map window, you can see how the fabric and its elements are organized (e.g., switches and hosts).

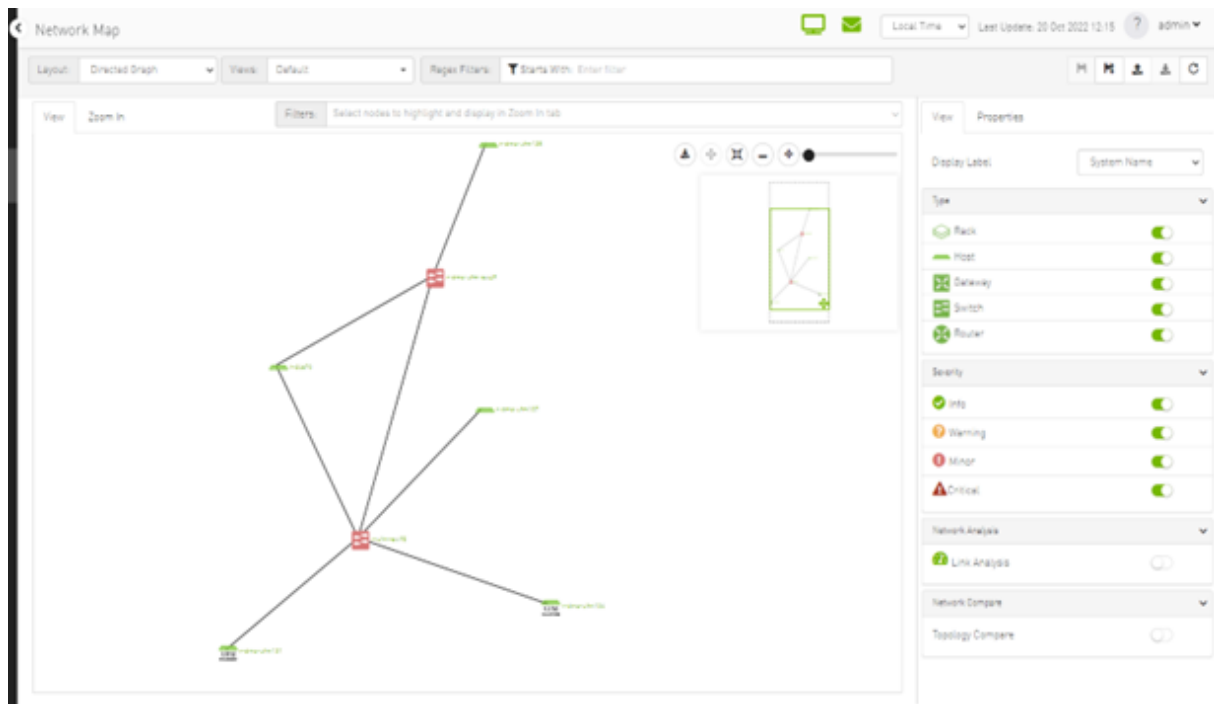

9.2.1 Network Map Components

Component	Icon	Description
Switches		Represents third party switches discovered/managed by UFM
Hosts		Represents the computer (host) connected to the discovered/managed switches
Routers		Represents third party routers discovered/managed by UFM
Gateways		Represents third party gateways discovered/managed by UFM
Links		Represents the connections between devices on the fabric
Racks		Represents all nodes (hosts) physically connected to a switch

The level of severity of devices affects the color they are displayed in. For further information, refer to table "[Device Severity Levels](#)".

- To zoom in/out of the map, scroll the mouse wheel up and down or using the slider on the right top corner
- To move around in the map, press and hold down the left key while you move sideways and up/down
- To see the hosts inside a rack, right-click the Rack icon and click "Expand Hosts"

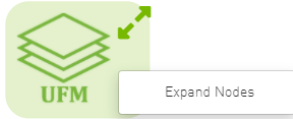

9.2.2 Selecting Map Elements

Users are able to select elements from the Network Map. Right-clicking an element opens a context menu which allows users to perform actions on it.

It is possible to select multiple elements at once using any of the following methods:

- By holding down Ctrl or Shift and dragging their mouse across the map.

Please note that Ctrl starts new selection, while Shift adds to the current selection.

- By holding down Shift and clicking a new element on the map.

Multi-select makes it possible for users to perform actions on multiple devices with one right-click rather than repeating the same process per device.

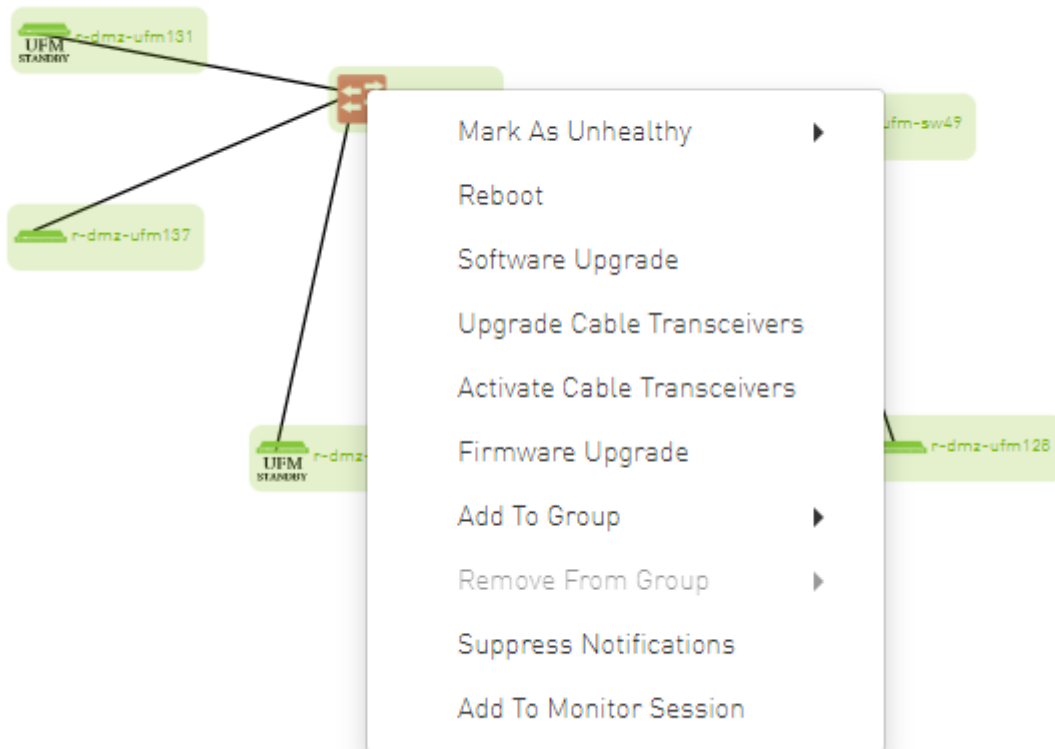





9.2.3 Map Information and Settings

The right pane of the Network Map view enables you to control the view settings, as well as obtain further information on selected elements from the map.





View Properties

Display Label System Name

Type

 Rack	<input checked="" type="checkbox"/>
 Host	<input checked="" type="checkbox"/>
 Gateway	<input checked="" type="checkbox"/>
 Switch	<input checked="" type="checkbox"/>
 Router	<input checked="" type="checkbox"/>

Severity

 Info	<input checked="" type="checkbox"/>
 Warning	<input checked="" type="checkbox"/>
 Minor	<input checked="" type="checkbox"/>
 Critical	<input checked="" type="checkbox"/>





Network Analysis



 Link Analysis	<input type="checkbox"/>
---------------------------------------------------------------------------------------------------	--------------------------

The customized views created using the type and severity filters, selected fabric nodes, zoom level, and Expand/Collapse All Racks options can be saved for later access. These customized views can be saved and accessed using the bar available on top of the Network Map:

Views: Default



Regex Filters: Starts With: Enter filter

    

- "Save As" icon () saves newly created customized views
- "Save" icon () saves edits performed on existing views

- “Import” icon () import map from local device. The file format should be txt



- “Export” icon () export network as text file
- To reload/refresh the network map, use the refresh icon ().
- Drop down menu gives access to all previously saved views

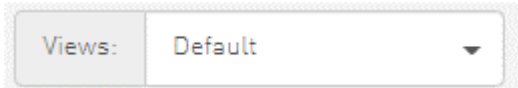

- “Default” view is a predefined view where nodes are positioned randomly, all filters are enabled, and all racks are collapsed. Changes made to this view cannot be saved unless under a new view name using the “Save As” icon.



- Saved views can be deleted using the “x” button.

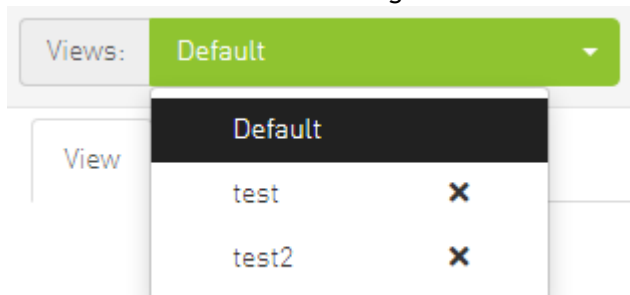

You can select a node from the dropdown menu located above the Network Map view in order to highlight/display them in the “Zoom In” tab.

The screenshot shows a network management interface. At the top, there are two tabs: 'smg-ib-svr46' and 'smg-ib-svr033'. Below the tabs, a list of nodes is displayed, including 'ufm-appliance-5752c2', 'smg-ib-svr027', 'smg-ib-svr032', 'smg-ib-apl009-gen2', 'smg-ib-svr031', 'smg-ib-sw32', and 'sma-ib-ola001-mamt01'. A 'Filters' bar at the bottom contains several selected filters: 'r-dmz-ufm134', 'r-dcs96', 'r-dmz-ufm131', 'r-dmz-ufm137', 'r-dmz-ufm128', and 'r-dmz-ufm-sw49'. Below the filters, a network map is shown with nodes and connections. The nodes are represented by icons and labels, and the connections are shown as lines. The nodes are: 'r-dmz-ufm134', 'r-dcs96', 'r-dmz-ufm131', 'r-dmz-ufm137', 'r-dmz-ufm128', and 'r-dmz-ufm-sw49'. The nodes are connected in a star-like topology, with 'r-dmz-ufm134' and 'r-dmz-ufm131' connected to a central node, and 'r-dmz-ufm137' and 'r-dmz-ufm128' connected to another central node. The nodes are highlighted with red circles.

9.2.4 Map View Tab

The Network Map "View" tab displays the fabric containing all nodes (e.g. switches, racks including the hosts, etc).

If your fabric consists of more than 500 nodes, please note that:

- The "View" tab will show only the switches in your fabric. Therefore, "Expand all racks" and "Rack filter" functions will be disabled.
- Link analysis will be disabled.

To have a better experience in this instance, you can switch to the "Zoom In" tab.

9.2.5 Map Zoom In Tab

The Network Map "Zoom In" tab displays only the selected nodes from the dropdown menu above the map view and the nodes directly connected to the selected nodes.

Network Map

Views: Default

unmanaged-HDR x smg-ib-sw014 x smg-ib-svr032 x

View Zoom In

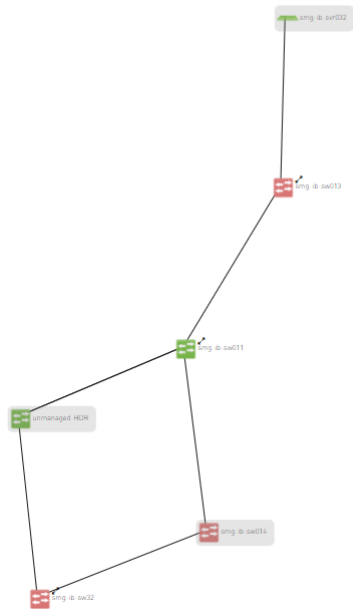

If some switches still have hidden connected nodes, you will see the following icon:

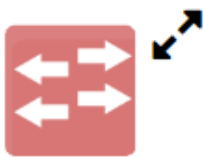

To reveal the hidden nodes connected to this switch, you can right-click it and select "Show Pairs" which adds this switch to the selected nodes list and shows the direct connected nodes to this switch.

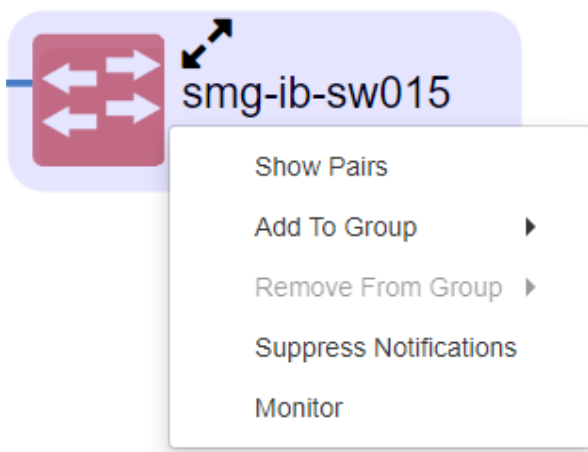

9.2.6 Map Layouts

Layout controls nodes positions in the map. UFM network map supports two types of layouts:

- Directed layout: the nodes are distributed depending on the connections between them so that the connected nodes will be near each other without conflict.

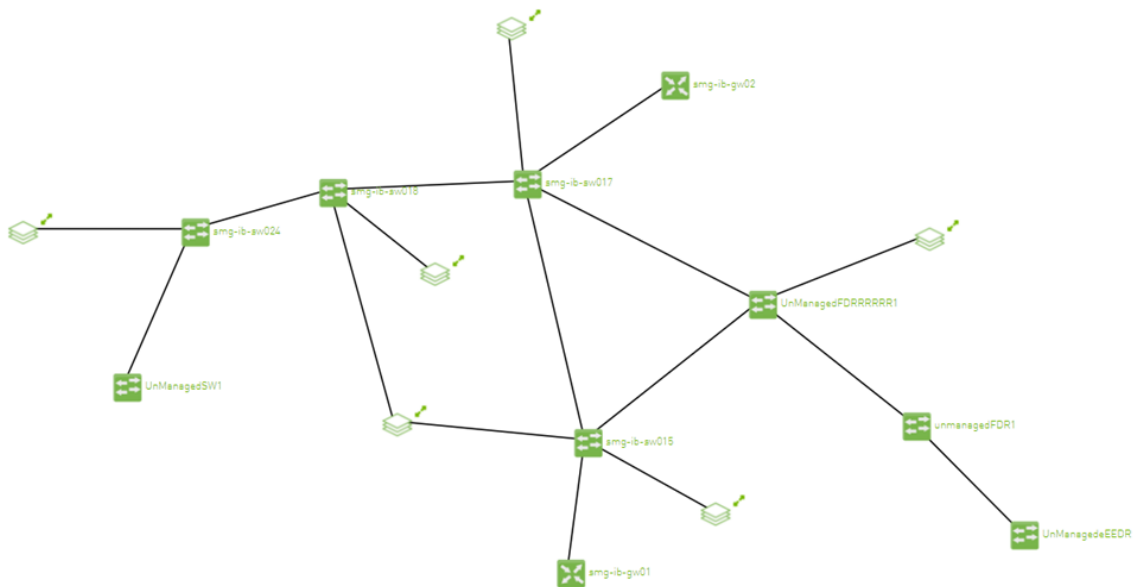

- Hierarchical layout: the nodes are distributed as layers; each layer will contain nodes that have the same level value.

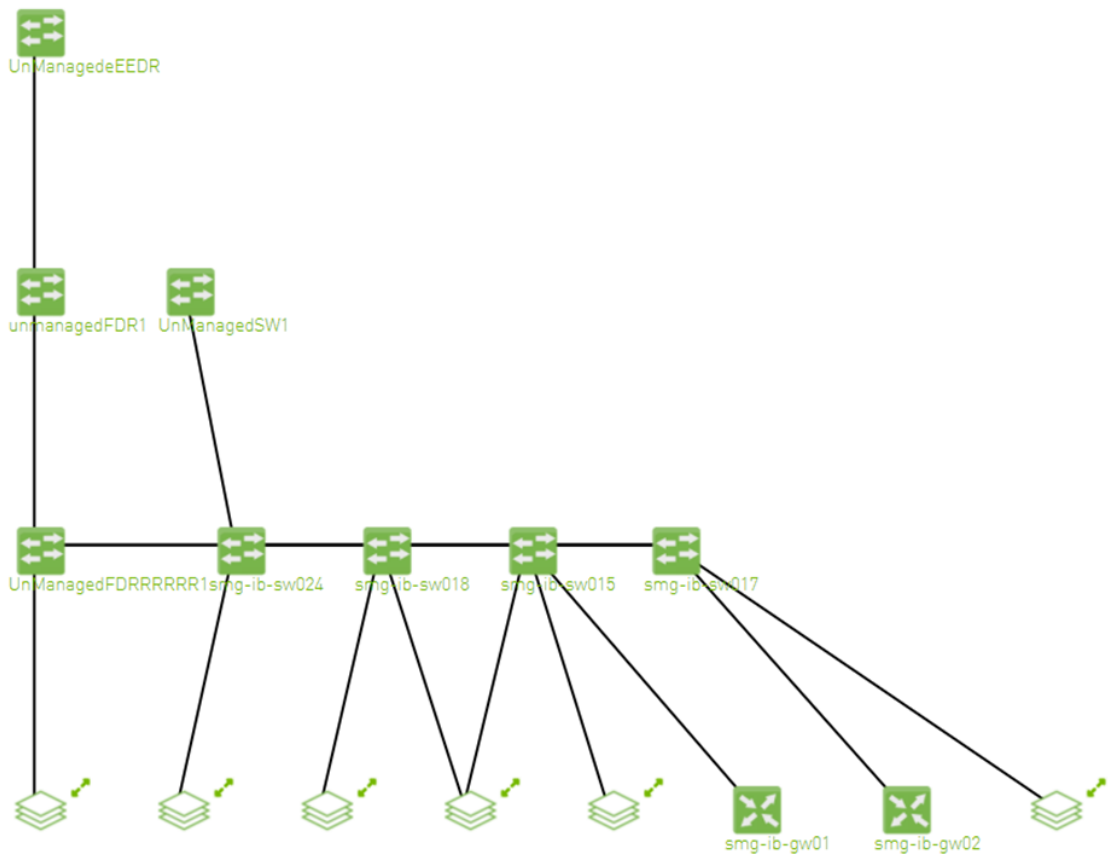

You can switch between layouts from the dropdown menu located above the Network Map view.

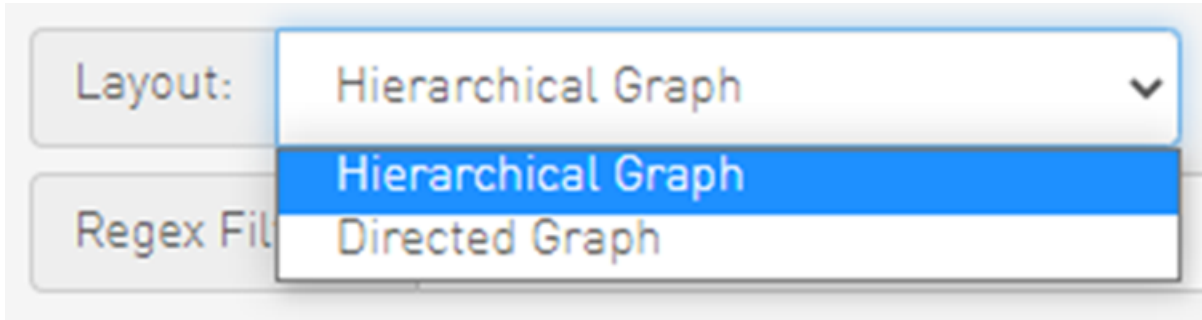

The default layout for small fabric (less than 30 nodes) is hierarchical and for large fabric is directed.



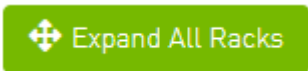

9.2.7 Information View Tab

- Enables searching for one or more elements in the map, by typing either their name or their GUID in the Search field. Note that the search mechanism is not case-sensitive.
- Enables displaying the elements either by their name, GUID, or IP.
- Enables viewing all hosts of all racks in the fabric using the "Expand All Racks" button.



- Enables customizing the view of the map by filtering for certain elements to appear in the map using the Type (see table "[Network Map Components](#)") and Severity (see table "[Device Severity Levels](#)") filters. Example:

Device Severity Levels

Component	Description
	Info
	Critical
	Minor
	Warning

9.2.8 Link Analysis

Link analysis allows the user to display the link analytics according to a selected static counter, and define the conditions on which the analysis is based. The links are colored according to the specified conditions. It is possible to define up to five conditions per counter.

The counter's conditions are applied on four values:

- The source values of the selected counter
- The destination value of the selected counter
- The source value of the opposite of the selected counter
- The destination value of the opposite of the selected counter





The worst matched value between these four is taken into consideration.

The "Network Analysis" section on the right side under the View tab contains a radio button to enable/disable the link analysis.





View Properties

Display Label System Name

Type

 Rack	<input checked="" type="checkbox"/>
 Host	<input checked="" type="checkbox"/>
 Gateway	<input checked="" type="checkbox"/>
 Switch	<input checked="" type="checkbox"/>
 Router	<input checked="" type="checkbox"/>

Severity

 Info	<input checked="" type="checkbox"/>
 Warning	<input checked="" type="checkbox"/>
 Minor	<input checked="" type="checkbox"/>
 Critical	<input checked="" type="checkbox"/>

Network Analysis

 Link Analysis

Counter:

Port RX Data +

To define a condition:

1. Select the desired counter, and click the + button.

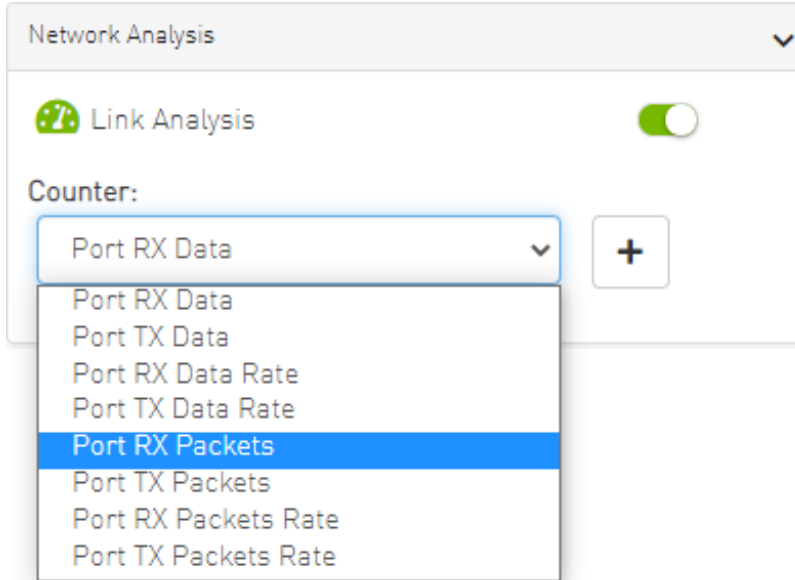

2. Select the appropriate operator, and define the desired threshold and color on the form that pops up. This color is applied on the link if the link monitoring value matches the respective condition.

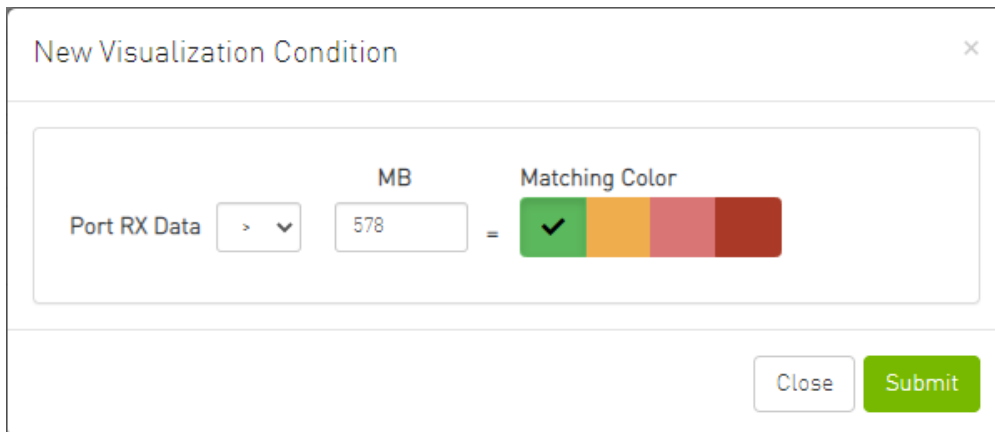

The colors are sorted from the lowest to the highest priority (i.e from left to right, green to red).

The counter's conditions are sorted based on the threshold values:

- Ascending if the operator is greater than (>)
- Descending if the operator is smaller than (<)

Last matched condition's color are taken into consideration in the link coloring.

3. Once the condition is set, the network map lights up the links that meet your condition.

The screenshot displays a network management interface. On the left, a network map shows a central switch (red icon) connected to several other devices (green icons). The devices are labeled with IDs like 'n-dmz-ufm131', 'n-dmz-ufm137', 'n-dmz-ufm134', 'n-dmz-ufm128', and 'n-dmz-ufm128'. The links between the central switch and the devices are highlighted in orange, indicating they meet a specific condition. On the right, a 'Properties' panel is visible. It has a 'View' tab and a 'Properties' tab. The 'Display Label' is set to 'System Name'. Under the 'Type' section, there are checkboxes for 'Rack', 'Host', 'Gateway', 'Switch', and 'Router', all of which are checked. Under the 'Severity' section, there are checkboxes for 'Info', 'Warning', 'Minor', and 'Critical', all of which are checked. Under the 'Network Analysis' section, there is a checkbox for 'Link Analysis' which is checked. Below this, there is a 'Counter' section with a dropdown menu set to 'Port RX Data' and a '+' button. At the bottom of the 'Network Analysis' section, there are two conditions listed: 'Port RX Data > 0 Gb' (with a green square icon) and 'Port RX Data > 140 Gb' (with an orange square icon). The 'Network Compare' section is partially visible at the bottom.

Note how the added conditions are listed in the Network Analysis section, if Link Analysis is enabled, and they are colored accordingly.

Link 1

Link/Port Properties ▼		
Property	Source	Destination
System GUID	0x248a0703 00ef19a0	0x7cfe900300 292356
Port	23	HCA-1/1
MTU	4096	4096
Width	4X	4X
Speed	FDR	FDR
Port RX Data	20379.9 Gb	5.9 Gb
Port TX Data	18.05 Gb	98.75 Gb
Port RX Data Rate	0 Gb/s	0 Gb/s
Port TX Data Rate	0 Gb/s	0 Gb/s
Port RX Packets	2533520412 5 Packets	45788053 Packets
Port TX Packets	1172677890 Packets	44948657 Packets
Port RX Packets Rate	2.9 Packets/s	2.9 Packets/s
Port TX Packets Rate	2.9 Packets/s	2.9 Packets/s

Source Cable Info	
Property	Value
Part Number	MC2207130-00A
Length	1 m
Serial Number	MT1618VS05669
Identifier	QSFP+
Technology	Copper cable- unequalized
Revision	A3

Destination Cable Info	
Property	Value
Part Number	MC2207130-00A
Length	1 m
Serial Number	MT1618VS05669
Identifier	QSFP+
Technology	Copper cable- unequalized
Revision	A3

Notice how the monitored counter is presented in boldface, and the background color is presented with the worst matched condition.

Please note that if the current layout and view are saved, the defined conditions are saved inside the view being saved.

9.2.9 Topology Compare

It is possible to enable the [Topology Compare](#) feature from the View tab in the right-hand pane. When the radio button is enabled, it is possible to compare the current topology with the master topology or with a custom topology whose `.topo` file you may upload.

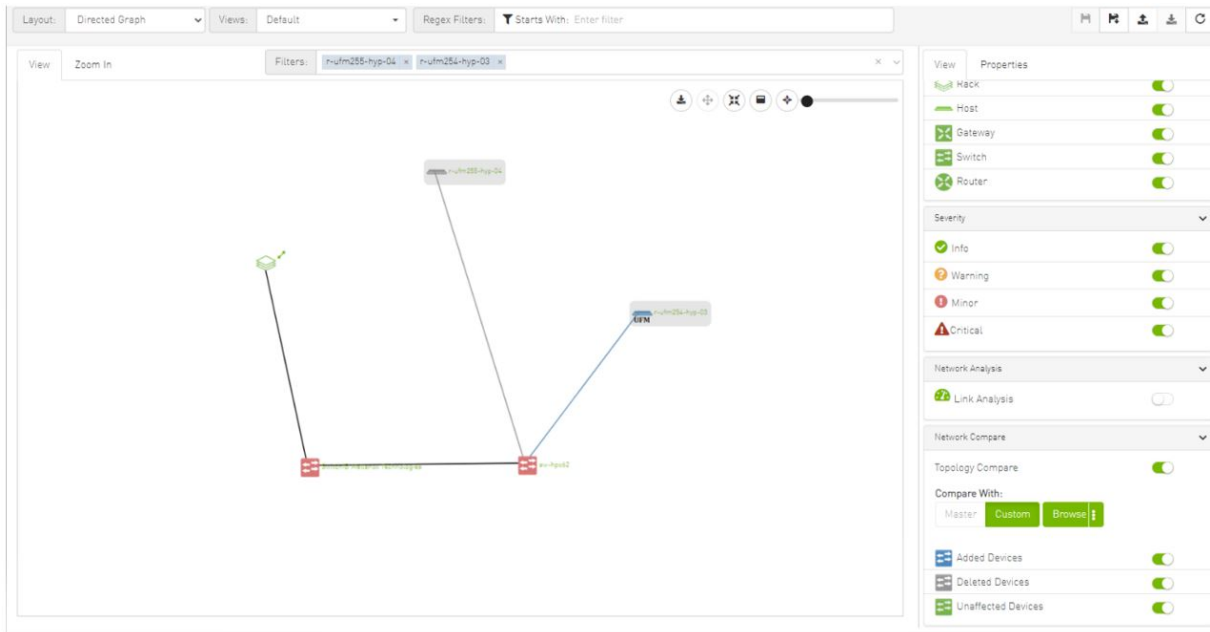

Topology compare key:

- A blue node signifies an added node
- A gray host signifies a deleted node
- A gray and black line signifies that some links were deleted and others were unchanged
- A gray and blue line signifies that some links were deleted, and others were added
- A gray, blue, and black line signifies that some links were deleted, some were added, and some were unchanged
- A blue and black line signifies that some links were added, and some were unchanged

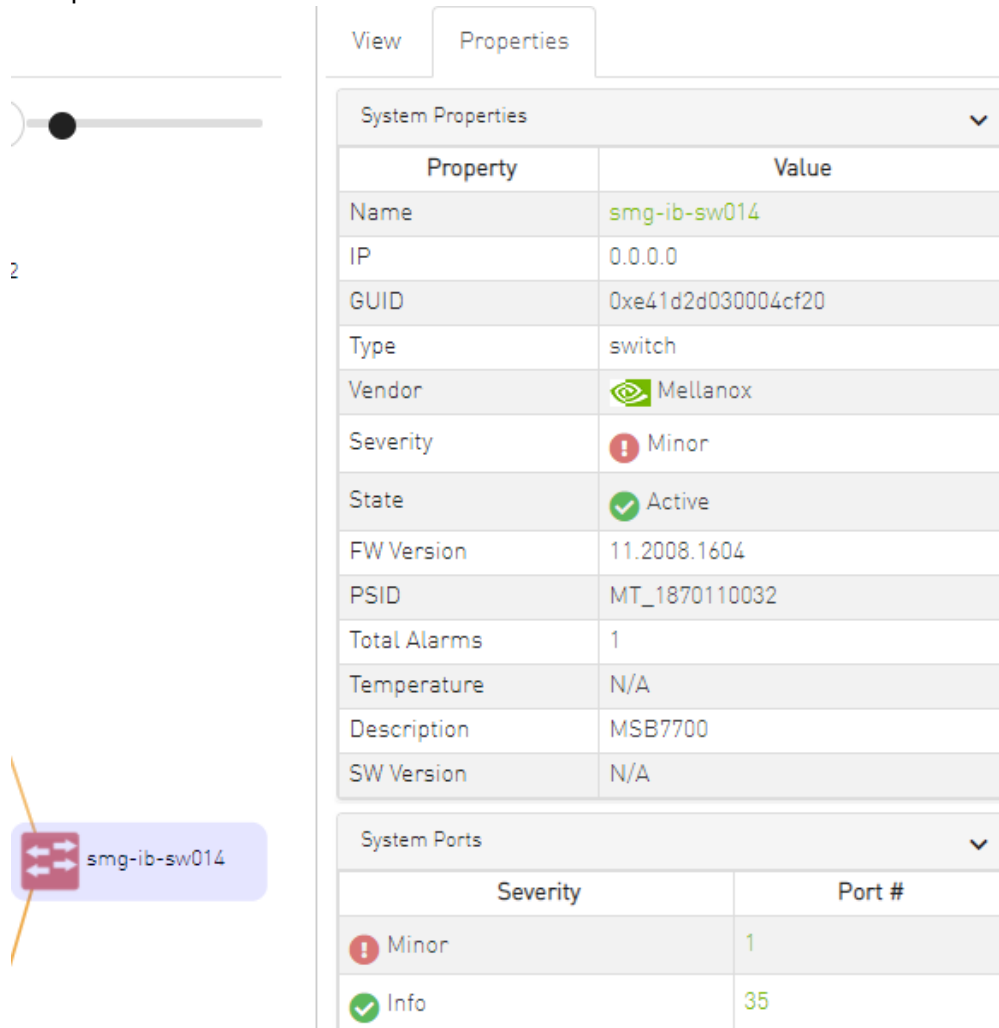

9.2.10 Properties Tab

- Provides details on a specific system selected from the map, as shown in the following example:





View Properties

System Properties

Property	Value
Name	smg-ib-sw014
IP	0.0.0.0
GUID	0xe41d2d030004cf20
Type	switch
Vendor	 Mellanox
Severity	 Minor
State	 Active
FW Version	11.2008.1604
PSID	MT_1870110032
Total Alarms	1
Temperature	N/A
Description	MSB7700
SW Version	N/A

System Ports

Severity	Port #
 Minor	1
 Info	35

- Provides link/port properties and cable info on a specific link selected from the map, including destination and source ports, as shown in the following example:

View Properties

Link 1

Collect System Dump

Link/Port Properties		
Property	Source	Destination
System GUID	0x0008f105002020fb	0x248a070300f88fe0
Port	18	1
MTU	4096	4096
Width	4X	4X
Speed	EDR	EDR
Port RX Data	614 MB	164 MB
Port TX Data	164 MB	614 MB
Port RX Data Rate	0 MB/s	0 MB/s
Port TX Data Rate	0 MB/s	0 MB/s
Port RX Packets	1662888 Packets	597647 Packets
Port TX Packets	597646 Packets	1662723 Packets
Port RX Packets Rate	0.45 Packets/s	0.25 Packets/s
Port TX Packets Rate	0.25 Packets/s	0.45 Packets/s

Cable Info	
Property	Value
Part Number	MCP1600-E00A
Length	1 m
Serial Number	MT1714VS00778
Identifier	QSFP+
Technology	Copper cable- unequalized
Revision	A2

9.2.11 Network Map Elements Actions

In the Network Map, a right-click on any of the elements enables performing a set of actions depending on the element type and its capabilities. See the list of available actions for each element type in the tables below.

9.2.11.1 Supported Actions for Internally Managed Switches

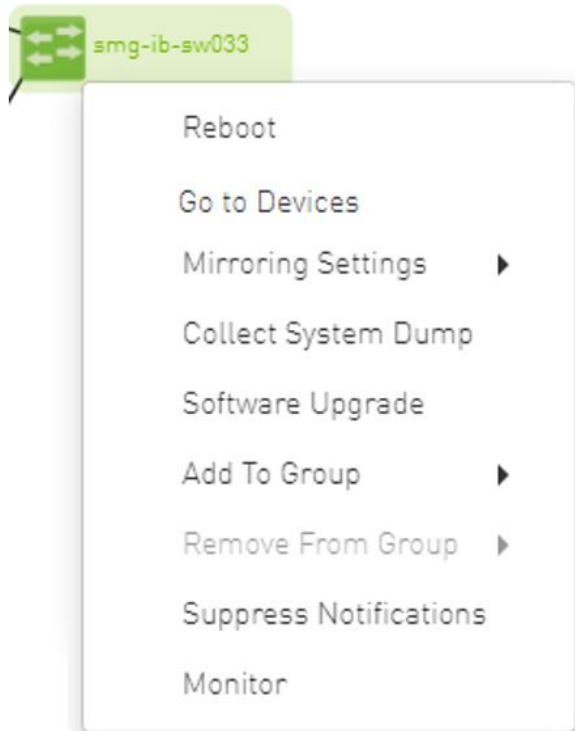

Element Type	Supported Actions	Description
Managed Switch	Reboot	Reboot the switch software
	Mirroring Settings	Set the mirroring configuration for the switch
	Collect System Dump	Collect system dump from the device
	Software Upgrade	Perform switch software upgrade
	Add to Group	Add switch to logical group
	Remove from Group	Remove switch from logical group
	Suppress Notification	Suppress all event notifications for the switch
	Monitor	Configure and activate switch monitoring
	Go to Devices	Go to devices page and select the device

9.2.11.2 Supported Actions for Externally Managed Switches

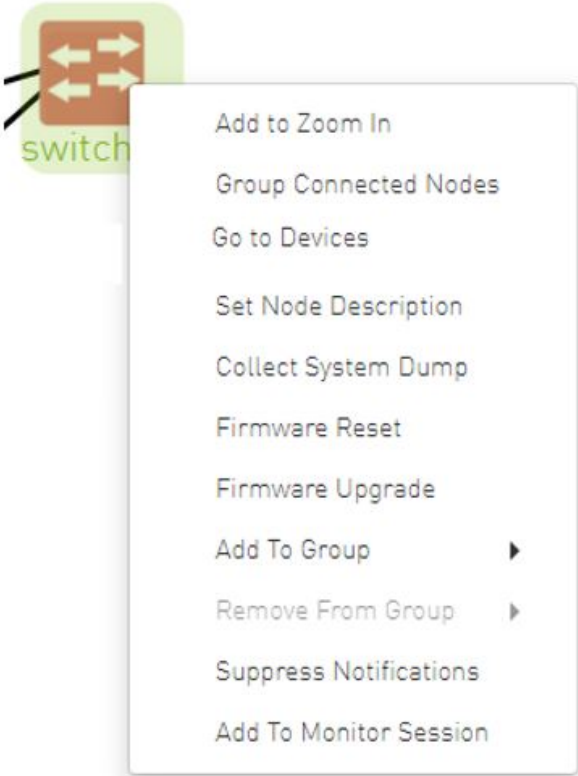

Element Type	Supported Actions	Description
Externally Managed Switch	Set Node Description	Sets description for specific node
	Firmware Reset	Perform switch firmware reset
	Firmware Upgrade	Perform switch firmware upgrade
	Add to Group	Add switch to logical group
	Remove from Group	Remove switch from logical group
	Suppress Notification	Suppress all event notifications for the switch
	Monitor	Configure and activate switch monitoring
	Go To Devices	Go to devices page and select the device

9.2.11.3 Supported Actions for Hosts

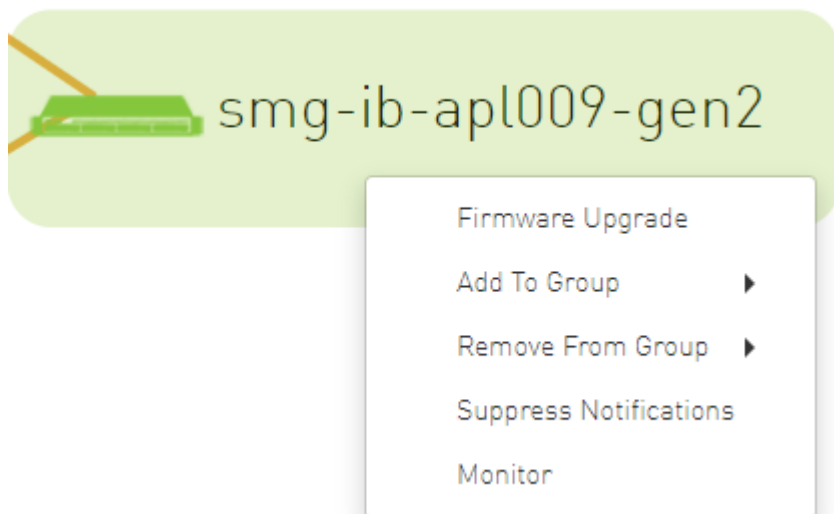

Element Type	Supported Actions	Description
Hosts	Firmware Upgrade	Perform switch firmware upgrade
	Add to Group	Add host to logical group
	Remove from Group	Remove host from logical group
	Suppress Notification	Suppress all event notifications for the host
	Monitor	Configure and activate host monitoring

9.3 Managed Elements

The UFM Managed Elements window allows you to obtain information on the fabric physical elements, such as devices, ports and cables.

All information provided in a tabular format in UFM web UI can be exported into a CSV file.

- [Devices Window](#)
- [Ports Window](#)
- [Virtual Ports Window](#)
- [Unhealthy Ports Window](#)
- [Cables Window](#)
- [Groups Window](#)
- [Inventory Window](#)
- [PKeys Window](#)
- [HCAs Window](#)

9.3.1 Devices Window



The Devices window shows data pertaining to the physical devices in a tabular format.

Severity	Name	GUID	Type	Model	IP	Firmware Version
Minor	r-dmz-ufm-sw49	0x0002c903007b78b0	switch	SX6036	fcfc.fcfc:209.36:202.e...	9.4.5110
Minor	r-ufm-sw95	0xb8599f0300fc6de4	switch	MQM8700	fcfc.fcfc:209.36:ba59...	27.2022.612
Info	r-dmz-ufm134	0x1070fd03000b22f8	host		192.168.1.153	22.34.282
Info	r-dcs96	0x1070fd030071ea4e	host		0.0.0.0	20.31.1014
Info	r-dmz-ufm131	0x1070fd03000b22c4	host		0.0.0.0	22.34.282
Info	r-dmz-ufm137	0x1070fd03000b22cc	host		0.0.0.0	22.32.1062
Info	r-dmz-ufm128	0xe41d2d03005cf34c	host		0.0.0.0	12.22.252

Devices Window Data

Data Type	Description
Health	Health of the device reflecting the highest alarm severity. Please refer to the Health States table.
Name	Name of the device If UFM Agent is running on a device, the following icon will appear next to the device name: 
GUID	System GUID of the device
Type	Type of the device: switch, node, IB router, and getaway
IP	IP address of the device
Vendor	The vendor of the device
Firmware Version	The firmware version installed on the device

Health States

Icon	Name	Description
	Normal	Information/notification displayed during normal operating state or a normal system event.
	Critical	Critical means that the operation of the system or a system component fails.
	Minor	Minor reflects a problem in the fabric with no failure.

Icon	Name	Description
	Warning	Warning reflects a low priority problem in the fabric with no failure. A warning is asserted when an event exceeds a predefined threshold.

A right-click on the device name displays a list of actions that can be performed on it.

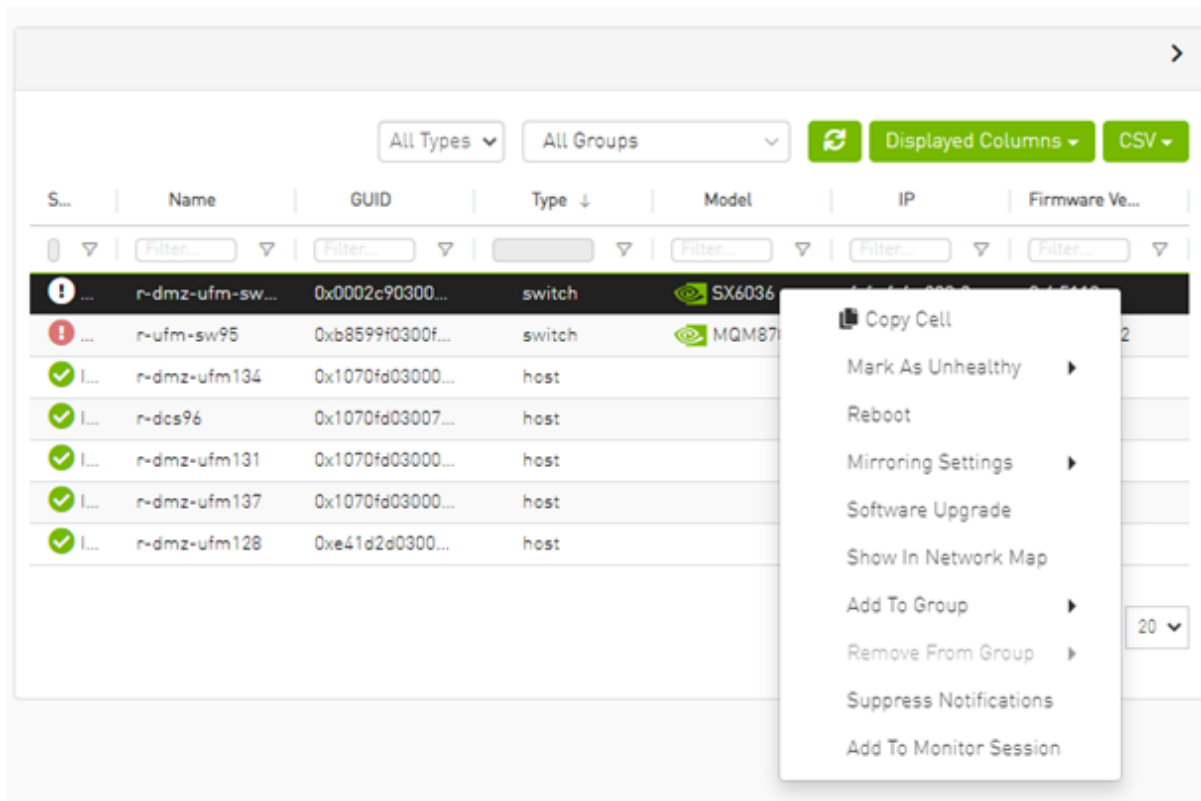

Devices Actions

Action	Description
Firmware Upgrade	Perform a firmware upgrade on the selected device
Firmware Reset	Reboot the device. This action is only applicable to unmanaged hosts (servers).
Set Node Description	Configure a description to this node
Collect System Dump	Collect the system dump log for a specific device
Add to Group	Add the selected device to a devices group
Remove from Group	Remove the selected device from a devices group
Suppress Notifications	Suppress all event notifications for the device
Add to Monitor Session	Configure and activate host monitoring
Show in Network Map	Move to Zoom In tab in network map and add the selected device to filter list

Collecting system dump for hosts, managed by UFM, is available only for hosts which are set with a valid IPv4 address and installed with MLNX_OFED.

9.3.1.1 Mark Device as Unhealthy

From the Devices table, it is possible to mark devices as healthy or unhealthy using the context menu (right-click).

There are two options for marking a device as unhealthy:

- Isolate
- No Discover

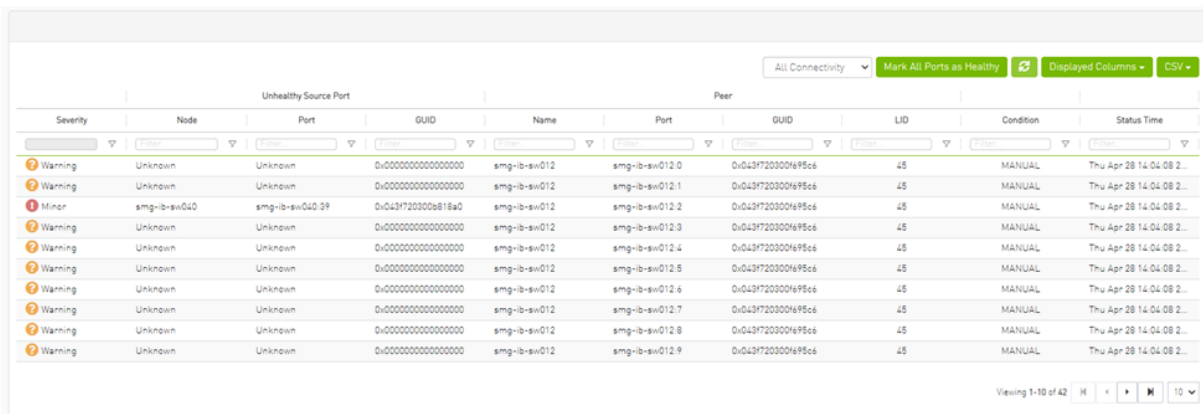
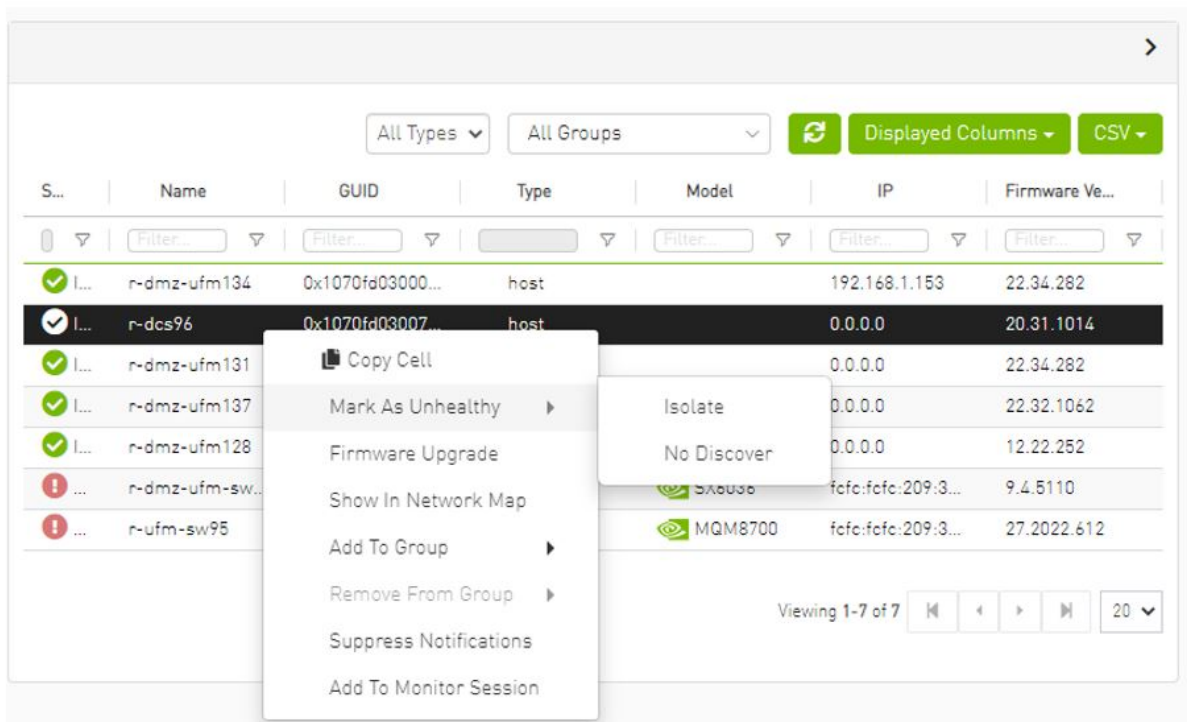

Server: `conf/opensm/opensm-health-policy.conf` content:

```

0xe41d2d030003e3b0 34 UNHEALTHY isolate
0xe41d2d030003e3b0 19 UNHEALTHY isolate
0xe41d2d030003e3b0 3 UNHEALTHY isolate
0xe41d2d030003e3b0 26 UNHEALTHY isolate
0xe41d2d030003e3b0 0 UNHEALTHY isolate
0xe41d2d030003e3b0 27 UNHEALTHY isolate
0xe41d2d030003e3b0 7 UNHEALTHY isolate
0xe41d2d030003e3b0 10 UNHEALTHY isolate
0xe41d2d030003e3b0 11 UNHEALTHY isolate
0xe41d2d030003e3b0 22 UNHEALTHY isolate
0xe41d2d030003e3b0 18 UNHEALTHY isolate
0xe41d2d030003e3b0 29 UNHEALTHY isolate
0xe41d2d030003e3b0 8 UNHEALTHY isolate
0xe41d2d030003e3b0 5 UNHEALTHY isolate
0xe41d2d030003e3b0 17 UNHEALTHY isolate
0xe41d2d030003e3b0 23 UNHEALTHY isolate
0xe41d2d030003e3b0 15 UNHEALTHY isolate
0xe41d2d030003e3b0 24 UNHEALTHY isolate
0xe41d2d030003e3b0 2 UNHEALTHY isolate
0xe41d2d030003e3b0 16 UNHEALTHY isolate
0xe41d2d030003e3b0 13 UNHEALTHY isolate
0xe41d2d030003e3b0 14 UNHEALTHY isolate
0xe41d2d030003e3b0 32 UNHEALTHY isolate
0xe41d2d030003e3b0 33 UNHEALTHY isolate
0xe41d2d030003e3b0 35 UNHEALTHY isolate
0xe41d2d030003e3b0 20 UNHEALTHY isolate
0xe41d2d030003e3b0 21 UNHEALTHY isolate
0xe41d2d030003e3b0 28 UNHEALTHY isolate
0xe41d2d030003e3b0 1 UNHEALTHY isolate
0xe41d2d030003e3b0 9 UNHEALTHY isolate
0xe41d2d030003e3b0 4 UNHEALTHY isolate
0xe41d2d030003e3b0 31 UNHEALTHY isolate
0xe41d2d030003e3b0 30 UNHEALTHY isolate
0xe41d2d030003e3b0 36 UNHEALTHY isolate
0xe41d2d030003e3b0 12 UNHEALTHY isolate
0xe41d2d030003e3b0 25 UNHEALTHY isolate
0xe41d2d030003e3b0 6 UNHEALTHY isolate

```

/opt/ufm/files/log/opensm-unhealthy-ports.dump content:



9.3.1.2 Mark Device as Healthy

The screenshot shows a table of devices with columns: S..., Name, GUID, Type, Model, IP, and Firmware Ve... The device 'r-dcs96' is selected, and a context menu is open over it with the following options: Copy Cell, Mark As Healthy, Firmware Upgrade, Show In Network Map, Add To Group, Remove From Group, Suppress Notifications, and Add To Monitor Session.

S...	Name	GUID	Type	Model	IP	Firmware Ve...
✓	r-dmz-ufm134	0x1070fd03000...	host		192.168.1.153	22.34.282
✓	r-dcs96	0x1070fd03007...	host		0.0.0.0	20.31.1014
✓	r-dmz-ufm131	0x1070fd03000...	host			22.34.282
✓	r-dmz-ufm137	0x1070fd03000...	host			22.32.1062
✓	r-dmz-ufm128	0xe41d2d0300...	host			12.22.252
!	r-dmz-ufm-sw...	0x0002c90300...	switch		09:3...	9.4.5110
!	r-ufm-sw95	0xb8599f0300f...	switch		09:3...	27.2022.612

Server /opt/ufm/files/conf/opensm/opensm-health-policy.conf content:

```

0xe41d2d030003e3b0 15 HEALTHY
0xe41d2d030003e3b0 25 HEALTHY

```

```

0xe41d2d030003e3b0 35 HEALTHY
0xe41d2d030003e3b0 0 HEALTHY
0xe41d2d030003e3b0 11 HEALTHY
0xe41d2d030003e3b0 21 HEALTHY
0xe41d2d030003e3b0 28 HEALTHY
0xe41d2d030003e3b0 7 HEALTHY
0xe41d2d030003e3b0 17 HEALTHY
0xe41d2d030003e3b0 14 HEALTHY
0xe41d2d030003e3b0 24 HEALTHY
0xe41d2d030003e3b0 34 HEALTHY
0xe41d2d030003e3b0 3 HEALTHY
0xe41d2d030003e3b0 10 HEALTHY
0xe41d2d030003e3b0 20 HEALTHY
0xe41d2d030003e3b0 31 HEALTHY
0xe41d2d030003e3b0 6 HEALTHY
0xe41d2d030003e3b0 16 HEALTHY
0xe41d2d030003e3b0 27 HEALTHY
0xe41d2d030003e3b0 2 HEALTHY
0xe41d2d030003e3b0 13 HEALTHY
0xe41d2d030003e3b0 23 HEALTHY
0xe41d2d030003e3b0 33 HEALTHY
0xe41d2d030003e3b0 30 HEALTHY
0xe41d2d030003e3b0 9 HEALTHY
0xe41d2d030003e3b0 19 HEALTHY
0xe41d2d030003e3b0 26 HEALTHY
0xe41d2d030003e3b0 36 HEALTHY
0xe41d2d030003e3b0 5 HEALTHY
0xe41d2d030003e3b0 12 HEALTHY
0xe41d2d030003e3b0 22 HEALTHY
0xe41d2d030003e3b0 32 HEALTHY
0xe41d2d030003e3b0 1 HEALTHY
0xe41d2d030003e3b0 8 HEALTHY
0xe41d2d030003e3b0 18 HEALTHY
0xe41d2d030003e3b0 29 HEALTHY
0xe41d2d030003e3b0 4 HEALTHY

```

`/opt/ufm/files/log/opensm-unhealthy-ports.dump` content:

```
# NodeGUID, PortNum, NodeDesc, PeerNodeGUID, PeerPortNum, PeerNodeDesc, {BadCond1, BadCond2, ...}, timestamp
```

9.3.1.3 Upgrading Software and Firmware for Hosts and Externally Managed Switches

9.3.1.3.1 Software/Firmware Upgrade via FTP

Software and firmware upgrade over FTP is enabled by the UFM Agent. UFM invokes the Software/Firmware Upgrade procedure locally on switches or on hosts. The procedure copies the new software/firmware file from the defined storage location and performs the operation on the device. UFM sends the set of attributes required for performing the software/firmware upgrade to the agent.

The attributes are:

- File Transfer Protocol - default FTP
 - The Software/Firmware upgrade on InfiniScale III ASIC-based switches supports FTP protocol for transmitting files to the local machine.
 - The Software/Firmware upgrade on InfiniScale IV-based switches and hosts supports TFTP and protocols for transmitting files to the local machine.
- IP address of file-storage server
- Path to the software/firmware image location

The software/firmware image files should be placed according to the required structure under the defined image storage location. Please refer to section [Devices Window](#).
- File-storage server access credentials (User/Password)

9.3.1.3.2 In-Band Firmware Upgrade

You can perform in-band firmware upgrades for externally managed switches and HCAs. This upgrade procedure does not require the UFM Agent or IP connectivity, but it does require current PSID recognition. Please refer to section [PSID and Firmware Version In-Band Discovery](#). This feature requires that the Mellanox Firmware Toolkit (MFT), which is included in the UFM package, is installed on the UFM server. UFM uses flint from the MFT for in-band firmware burning.

Before upgrading, you must create the firmware repository on the UFM server under the directory `/opt/ufm/files/userdata/fw/`. The subdirectory should be created for each PSID and one firmware image should be placed under it. For example:

```
/opt/ufm/files/userdata/fw/  
  MT_0D80110009  
    fw-ConnectX2-rel-2_9_1000-MHQH29B-XTR_A1.bin  
  MT_0F90110002  
    fw-IS4-rel-7_4_2040-MIS5023Q_A1-A5.bin
```

9.3.1.3.3 Directory Structure for Software or Firmware Upgrade Over FTP

Before performing a software or firmware upgrade, you must create the following directory structure for the upgrade image. The path to the `<ftp user home>/<path>/` directory should be specified in the upgrade dialog box.

```
<ftp user home>/<path>/  
  InfiniScale3 - For anafa based switches Software/Firmware upgrade images  
    voltaire_fw_images.tar - firmware image file  
    ibswmpr-<s/w version>.tar - software image file  
  InfiniScale4 - For InfiniScale IV based switches Software/Firmware upgrade images  
    firmware_2036_4036.tar - Firmware image file  
    upgrade_2036_4036.tgz - Software image file  
  OFED /* For host SW upgrade*/  
    OFED-<OS label>.tar.bz2  
  <PSID>* - For host FW upgrade  
    fw_update.img
```

The `<PSID>` value is extracted from the `mstflint` command:

```
mstflint -d <device> q
```

The device is extracted from the `lspci` command. For example:

```
# lspci  
06:00.0 InfiniBand: Mellanox Technologies MT25208 InfiniHost III Ex  
# mstflint -d 06:00.0 q | grep PSID  
PSID: VLT0040010001
```

9.3.1.3.4 PSID and Firmware Version In-Band Discovery

The device PSID and device firmware version are required for in-band firmware upgrade and for the correct functioning of Subnet Manager plugins, such as Congestion Control Manager and Lossy Configuration Management. For most devices, UFM discovers this information and displays it in the Device Properties pane. The PSID and the firmware version are discovered by the Vendor-specific MAD.

By default, the `gv.cfg` file value for `event_plugin_option` is set to `(null)`. This means that the plugin is disabled and `opemsm` does not send MADs to discover devices' PSID and FW version. Therefore, values for devices' PSID and FW version are taken from `ibdiagnet` output (section `NODES_INFO`).

The below is an example of the default value:

```
event_plugin_options = (null)
```

To enable the vendor-specific discovery by `opemsm`, in the `gv.cfg` configuration file, change the value of `event_plugin_option` to `(--vendinfo -m 1)`, as shown below:

```
event_plugin_options = --vendinfo -m 1
```

If the value is set to `--vendinfo -m 1`, the data should be supplied by `opemsm`, and in this case the `ibdiagnet` output is ignored.

In some firmware versions, the information above is currently not available.

9.3.1.3.5 Switch Management IP Address Discovery

From NVIDIA switch FM version 27.2010.3942 and up, NVIDIA switches support switch management IP address discovery using MADs. This information can be retrieved as part of `ibdiagnet run` (`ibdiagnet` output), and assigned to discover switches in UFM.

There is an option to choose the IP address of which IP protocol version that is assigned to the switch: IPv4 or IPv6.

The `discovered_switch_ip_protocol` key, located in the `gv.cfg` file in section `[FabricAnalysis]`, is set to 4 by default. This means that the IP address of type IPv4 is assigned to the switch as its management IP address. In case this value is set to 6, the IP address of type IPv6 is assigned to the switch as its management IP address.

After changing the `discover_switch_ip_protocol` value in `gv.cfg`, the UFM Main Model needs to be restarted for the update to take effect. The discovered IP addresses for switches are not persistent in UFM - every UFM Main Model restarts the values of management IP address which is assigned from the `ibdiagnet` output.

9.3.1.3.6 Upgrading Server Software

The ability to update the server software is applicable only for hosts (servers) with the UFM Agent.

To upgrade the software:

1. Select a device.
2. From the right-click menu, select Software Update.
3. Enter the parameters listed in the following table.

Parameter	Description
Protocol	Update is performed via FTP protocol
IP	Enter the host IP
Path	Enter the parent directory of the FTP directory structure for the Upgrade image. The path should not be an absolute path and should not contain the first slash (/) or trailer slash.
User	Name of the host username
Password	Enter the host password

4. Click Submit to save your changes.

9.3.1.3.7 Upgrading Firmware

You can upgrade firmware over FTP for hosts and switches that are running the UFM Agent, or you can perform an in-band upgrade for externally managed switches and HCAs.

Before you begin the upgrade ensure that the new firmware version is in the correct location. For more information, please refer to section [In-Band Firmware Upgrade](#).

To upgrade the firmware:

1. Select a host or server.
2. From the right-click menu, select Firmware Upgrade.
3. Select protocol In Band.
4. For upgrade over FTP, enter the parameters listed in the following table.

Parameter	Description
IP	Enter device IP
Path	Enter the parent directory of the FTP directory structure for the Upgrade image. The path should not be an absolute path and should not contain the first slash (/) or trailer slash.
Username	Name of the host username
Password	Enter the host password

5. Click submit to save your changes.

The firmware upgrade takes effect only after the host or externally managed switch is restarted.

9.3.1.3.8 Upgrade Cables Transceivers Firmware Version

The main purpose of this feature is to add support for burning of multiple cables transceiver types on multiple devices using linkx tool which is part of flint. This needs to be done from both ends of the cable (switch and HCA/switch).

To upgrade cables transceivers FW version:

1. Navigate to managed elements page
2. select the target switches and click on Upgrade Cable Transceivers option

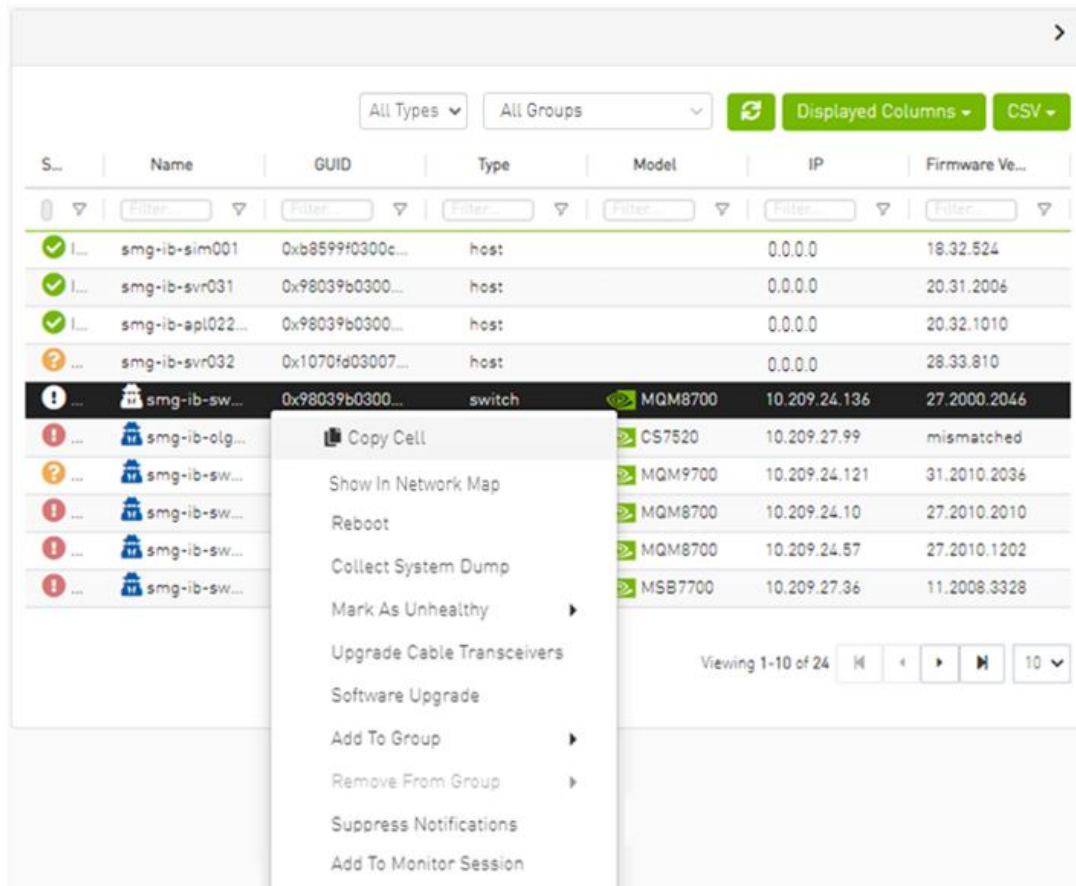

3. A model will be shown containing list of the active firmware versions for the cables of the selected switches, besides the version number, a badge will show the number of matched switches:

Upgrade Cable Transceivers



Firmware Image - Please select one of the available images or upload new one

Expert Mode ⓘ

Current Firmware Version

Transceiver Type

Image



> 38.100.122

1

Hercules2

No Selected Image ▾

Close

Submit

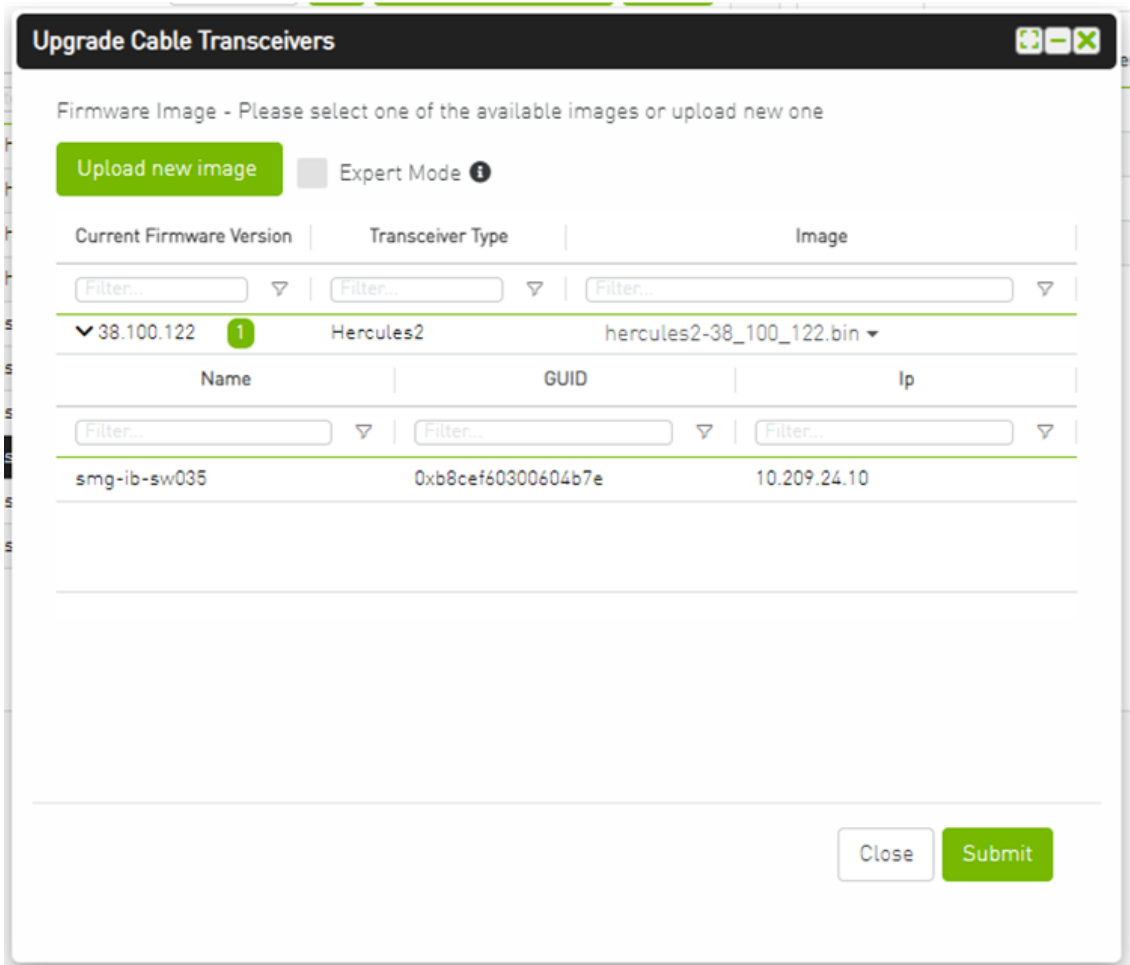

4. After the user clicks Submit, the GUI will start sending the selected binaries with the relevant switches sequentially, and a model with a progress bar will be shown (this model can be minimized):

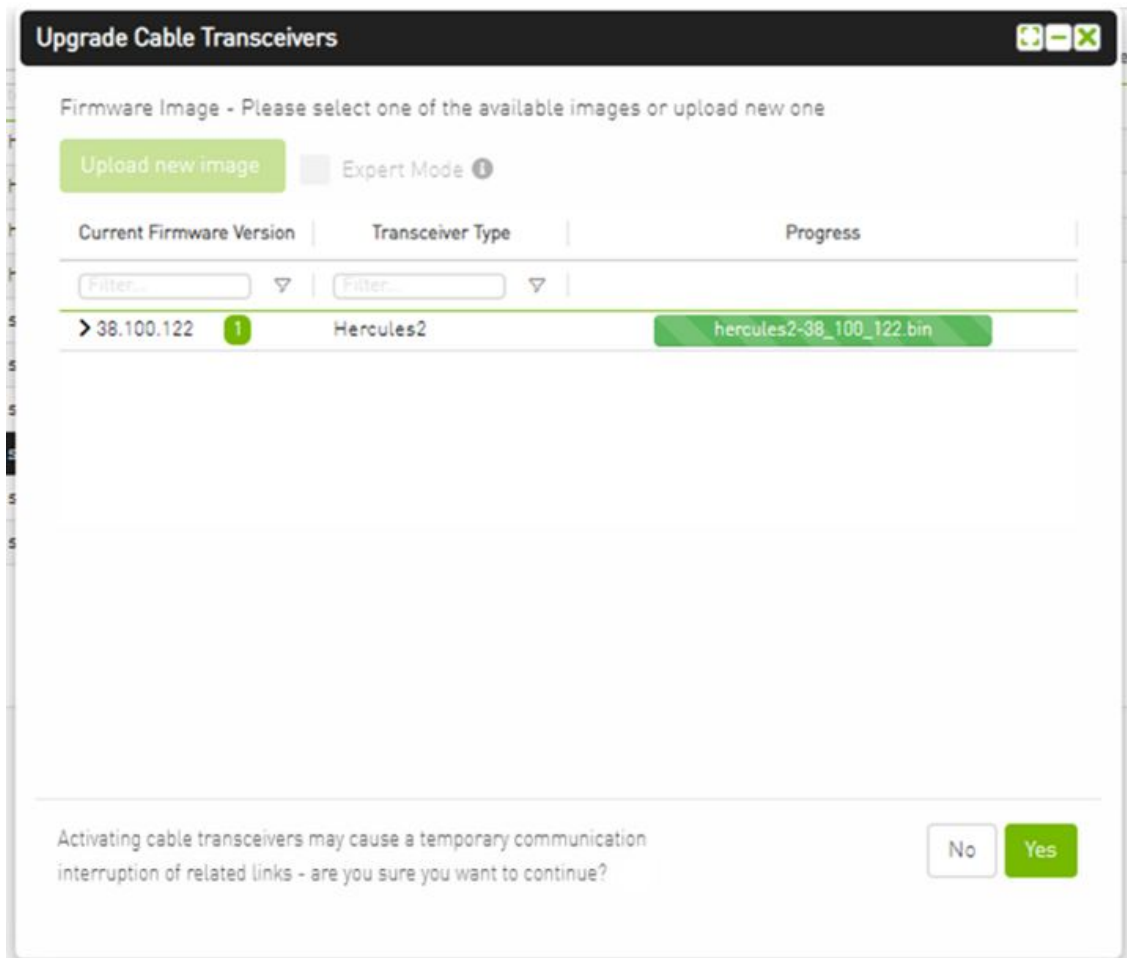

5. After the whole action is completed successfully, you will be able to see the following message at the model bottom The upgrade cable transceivers completed successfully, do you want to activate it? by clicking the yes button it will run a new action on all the burned devices to activate the new uploaded binary image.
6. Another option to activate burned cables transceivers you can go to the Groups page and right click on the predefined Group named Devices Pending FW Transceivers Reset or you can right click on the upgraded device from managed element page and select Activate cable Transceivers action.

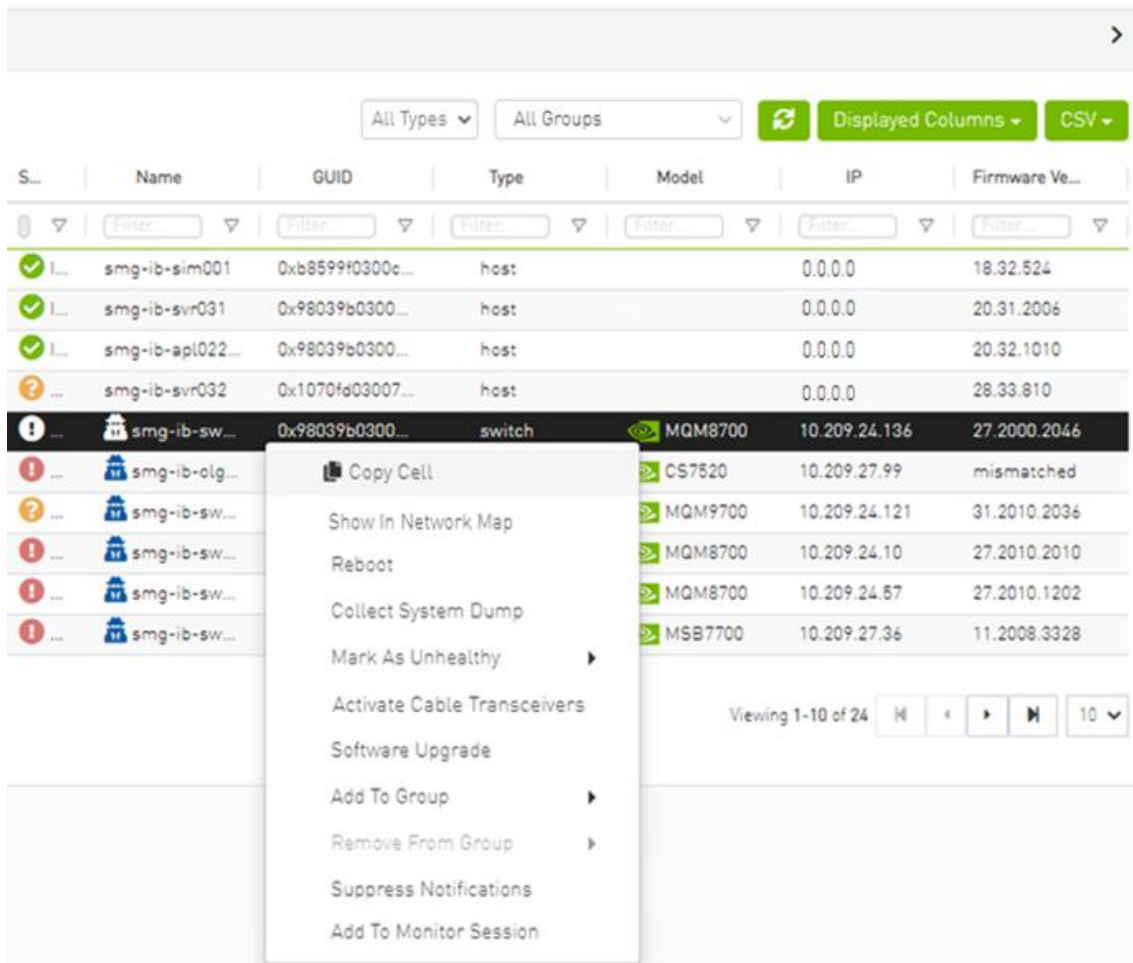

9.3.1.4 Device Information Tabs

Selecting a device from the Devices table reveals the Device Information table on the right side of the screen. This table provides information on the device's ports, cables, groups, events, alarms, , and device access.

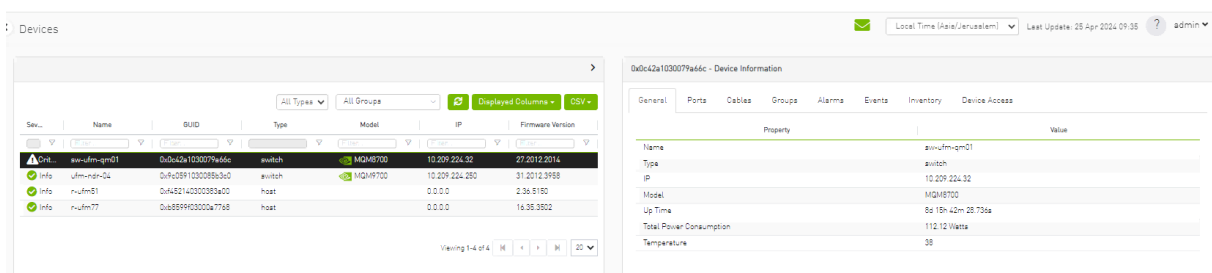

9.3.1.4.1 General Tab

Provides general information on the selected device.

0x0c42a1030079a66c - Device Information

General | Ports | Cables | Groups | Alarms | Events | Inventory | Device Access

Property	Value
Name	sw-ufm-qm01
Type	switch
IP	10.209.224.32
Model	MQM8700
Up Time	1d 22h 8m 35.312s
Total Power Consumption	112.88 Watts
Temperature	38

9.3.1.4.2 Ports Tab

This tab provides a list of the ports connected to this device in a tabular format.

0x98039b0300a8b71e - Device Information

General | **Ports** | Cables | Groups | Alarms | Events | Inventory | Device Access



Active ▾ | Displayed Columns ▾ | CSV ▾

Severity	State	System	Source Port	LID	Peer Node
		Name ▾ ↑	Port Name ▾		Name ▾
		Filter...	Filter...	Filter	Filter...
Info	✓	smg-ib-sw032	3	5	smg-ib-sw036
Minor	✓	smg-ib-sw032	5	5	smg-ib-sw036
Info	✓	smg-ib-sw032	16	5	smg-ib-sw056

Viewing 1-3 of 3

Ports Data

Data Type	Description
Port Number	The number of ports on device.
Node	The node name/GUID/IP that the port belongs to. Note that you can choose the node label (name/GUID/IP) using the drop-down menu available above the Ports data table.

Data Type	Description
Health	Health of the port reflecting the highest alarm severity. Please refer to the Health States table.
State	Indicates whether the port is connected (active or inactive).
LID	The local identifier (LID) of the port.
MTU	Maximum Transmission Unit of the port.
Speed 	Lists the highest value of active, enabled and supported speeds in icons indicating their status: <ul style="list-style-type: none"> • Dark green - active speed • Light green - enabled speed • Grey - supported yet disabled speed
Width 	Lists the highest value of active, enabled and supported widths in icons indicating their status: <ul style="list-style-type: none"> • Dark green - active width • Light green - enabled width • Grey - supported yet disabled width
Peer	The GUID of the device the port is connected to.
Peer Port	The name of the port that is connected to this port.

9.3.1.4.3 Cables Tab







This tab provides a list of the cables connected to this device in a tabular format.

0x248a070300ef19a0 - Device Information

General Ports **Cables** Groups Alarms Events Inventory

Device Access

Displayed Columns ▾ CSV ▾

Severity	Serial #	Identifier	GUID	Port
 Info	MT1618VS05669		0x248a070300ef19a0	r-hyp-sw-01:1
 Info	MT1544VS05091		0x248a070300ef19a0	r-hyp-sw-01:2
 Minor	MT1233VS01161		0x248a070300ef19a0	r-hyp-sw-01:3

Viewing 1-3 of 3 ⏪ ⏩ 20 ▾

Cables Data

Data Type	Description
Basic Information	
Health	Health of the cable reflecting the highest alarm severity. Please refer to the Health States table.
Serial Number	Serial number of the cable.
Identifier	Identifier of the cable.
Source Port Information	
Source GUID	GUID of the source port the cable is connected to.
Source Port	The number of the source port the cable is connected to.
Destination Port Information	
Destination GUID	GUID of the destination port the cable is connected to.
Destination Port	The number of the destination port the cable is connected to.
Advanced Information	
Revision	Revision of the cable.
Link Width	The maximum link width of the cable.
Part Number	Part number of the cable.
Technology	The transmitting medium of the cable: copper/optical/etc.
Length	The cable length in meters.

9.3.1.4.4 Groups Tab

This tab provides a list of the groups to which the selected device belongs.

0x98039b0300a8b71e - Device Information

General Ports Cables **Groups** Alarms Events Inventory Device Access

All Displayed Columns CSV

Severity	Name ↑	Description	Type
⚠ Critical	1U Switches	Includes all 1U Switches that exi...	General
⚠ Critical	Alarmed Devices	Devices with alarms	General
⚠ Critical	Switches	Includes all Switches that exist i...	General

Viewing 1-3 of 3 ⏪ ⏩ 10

Groups Data

Data Type	Description
Severity	Aggregated severity level of the group (the highest severity level of all group members).
Name	Name of the group.
Description	Description of the group.
Type	Type of the group: General/Rack.

9.3.1.4.5 Alarms Tab

This tab provides a list of all UFM alarms related to the selected device.

0x043f720300b818a0 - Device Information

General Ports Cables Groups **Alarms** Events Inventory Device Access

Clear All Alarms Refresh Displayed Columns CSV

Severity	Date/Time ↓	Source	Reason	C
Minor	2022-04-28 14:28:46	default(12) / Switch: smg-ib-s	Found a [50.0] link that oper...	26
Warning	2022-04-28 14:09:55	default(12) / Switch: smg-ib-s	Peer Port Mellanox Technol...	1
Critical	2022-04-28 14:08:24	default(12) / Switch: smg-ib-s	smg-ib-sw040: [system guid...	5
Warning	2022-04-28 14:04:48	default(12) / Switch: smg-ib-s	Peer Port smg-ib-sw012:2 is...	1

Viewing 1-4 of 4

Alarms Data

Data Type	Description
Alarms ID	Alarm identifier.
Source	Source object (device/port) on which the alarm was triggered.
Severity	The severity of the alarm.
Description	Description of the alarm.
Date/Time	The time when the alarm was triggered.
Reason	Reason for the alarm.
Count	Number of instances that the alarm occurred on the related source object.

9.3.1.4.6 Events Tab

This tab provides a list of the UFM events that are related to the selected device.

0x043f720300b818a0 - Device Information

General Ports Cables Groups Alarms **Events** Inventory Device Access

Clear All Events Refresh Displayed Columns CSV

Severity	Date/Time ↓	Source	Source Type	Description
Info	2022-04-28 14:16:42	default(12) / Switch: smg-ib-s	Switch	Action reboot on
Info	2022-04-28 14:10:13	default(12) / Switch: smg-ib-s	Switch	System Image G
Info	2022-04-28 14:10:13	default(12) / Switch: smg-ib-s	Switch	Capability Mask
Info	2022-04-28 14:09:24	default(12) / Switch: smg-ib-s	Switch	smg-ib-sw040: [
Warning	2022-04-28 14:08:24	Source 043f720300b818a0_39	Link	Link went down:
Warning	2022-04-28 14:08:24	Source 043f720300b818a0_41	Link	Link went down:
Info	2022-04-28 14:07:41	default(12) / Switch: smg-ib-s	Switch	Action reboot st:
Info	2022-04-28 14:04:14	default(12) / Switch: smg-ib-s	Switch	Switch Upgrade
Info	2022-04-28 14:02:42	default(12) / Switch: smg-ib-s	Switch	Switch SW upgrn
Info	2022-04-28 14:02:42	default(12) / Switch: smg-ib-s	Switch	Action sw_upgrn

Viewing 1-10 of 11

Events Data

Data Type	Description
Severity	Event severity - Info, Warning, Error, Critical or Minor.
Event Name	The name of the event.
Source	The source object (device/port) on which the event was triggered.
Date/Time	The time when the event was triggered.
Category	The category of the event indicated by icons. Hovering over the icon will display the category name.
Description	Description of the event. Full description can be displayed by hovering over the text.

9.3.1.4.7 Inventory Tab

This tab provides a list of the device’s modules with information in a tabular format.

This tab is available for switches only.

0x0c42a1030079a66c - Device Information

General Ports Cables Groups Alarms Events **Inventory** Device Access

Displayed Columns CSV

Severity	Status	Serial Num...	Sy...	Description	Type	Software V...	Part Num...	Hardware ...	Power
Info	OK	MT2019T11021	sw-ufm-qm01	SYSTEM	SYSTEM	3.11.2016-X8...	MQM8700-H...	AF	
Info	OK	MT2019T11021	sw-ufm-qm01	MGMT - 1	MGMT		MQM8700-H...	AF	
Info	OK		sw-ufm-qm01	FAN - 1	FAN				
Info	OK		sw-ufm-qm01	FAN - 3	FAN				
Info	OK		sw-ufm-qm01	FAN - 2	FAN				
Info	OK		sw-ufm-qm01	FAN - 5	FAN				
Info	OK		sw-ufm-qm01	FAN - 4	FAN				
Info	OK		sw-ufm-qm01	FAN - 6	FAN				
Info	OK	MT2019T10901	sw-ufm-qm01	PS - 2	PS		MTEF-PSF-A...	A3	109.88
Warning	fatal	MT2019T10902	sw-ufm-qm01	PS - 1	PS		MTEF-PSF-A...	A3	
Info	active		sw-ufm-qm01	Aggregation ...	SHARP				

Viewing 1-11 of 11

Inventory Data

Data Type	Description
Severity/Health	Health of the module reflecting the highest alarm severity. Please refer to the Health States table.
Status	The module status.
Serial Number	Serial number of the module.
System	Name of the device.
Description	Description of the module.
Type	Type of the module: spine/line/etc.
Software Version	Firmware version installed on the module.
Part Number	Part number of the module.
Hardware Version	Hardware version of the module.
Power	Power supply of the PSU.

9.3.1.4.8 HCAs Tab

This tab provides a list of the device's HCAs with information in a tabular format.

This tab is available for hosts only.

0xec0d9a0300bf551c - Device Information

General Ports Cables Groups Alarms Events **HCA**s Device Access

Displayed Columns CSV

Severity	System	Name	GUID	Type	Port 1	Name	Port 2
Info	smg-ib-svr45		0xec0d9a0300bf551c	ConnectX-5	smg-ib-svr45	HCA-3	smg-ib-
Info	smg-ib-svr45		0x98039b03009ffb22	ConnectX-6	smg-ib-svr45	HCA-1	smg-ib-

Viewing 1-2 of 2

Data Type	Description
Health	Health of the HCA reflecting the highest alarm severity. Please refer to the Health States table.
Name	HCA Index
GUID	HCA GUID
Type	HCA Type
Port GUID	HCA ports GUIDs
PSID	HCA PSID
FW Version	HCA firmware version

9.3.1.4.9 Device Access Tab

This tab allows for managing the access credentials of the selected device for remote accessibility. To be able to set access credentials for the device, a device IP must be set either by installing UFM Agent on the device, or by manually setting the IP under IP Address Settings (IP is now supported with v4 and v6).

0xe41d2d030021d450 - Device Information

General Ports Cables Groups Alarms Events Inventory **Device Access**

IP Address Settings

Mode Auto Manual

Static IP v4 v6

Device Access is not available right now, try enabling ufm agent or set manual IP from IP Address Settings Above

After manually setting the IP address of NVIDIA® Mellanox® InfiniScale IV® and SwitchX® based switches, UFM will first validate the new IP before setting it.

To edit your device access credentials

1. Select the preferred protocol tab:
 - SSH - allows you to define the SSH parameters to open an SSH session on your device (available for nodes and switches)
 - IPMI - allows you to set the IPMI parameters to open an IPMI session on your device for remote power control (available for nodes only)
 - HTTP - allows you to define the HTTP parameters to open an HTTP session on your device (available for switches only)

2. Click Update to save your changes.

0x98039b0300a8b71e - Device Information

General
Ports
Cables
Groups
Alarms
Events
Inventory
Device Access

IP Address Settings >

SSH v

Credentials

Override Global Settings

User:

Password:

Confirmation:

Connection

Port

Timeout

Manual IP
 v4 v6

HTTP >

Device Access Credentials Parameters

Field	Description
User	Fill in or edit the computer user name.
Password	Enter the device password.
Confirmation	Enter the device password a second time to confirm.
Manual IP	Enter the device IP address (could be IPv4/IPv6).
Port	Enter the port number.
Timeout	Enter the connection timeout (in seconds) for the device specific protocol (SSH/ HTTP/IPMI).

9.3.1.4.10 Virtual Networking Tab

This tab displays a map containing the HCAs for the selected device, and the ports and virtual ports it is connected to.

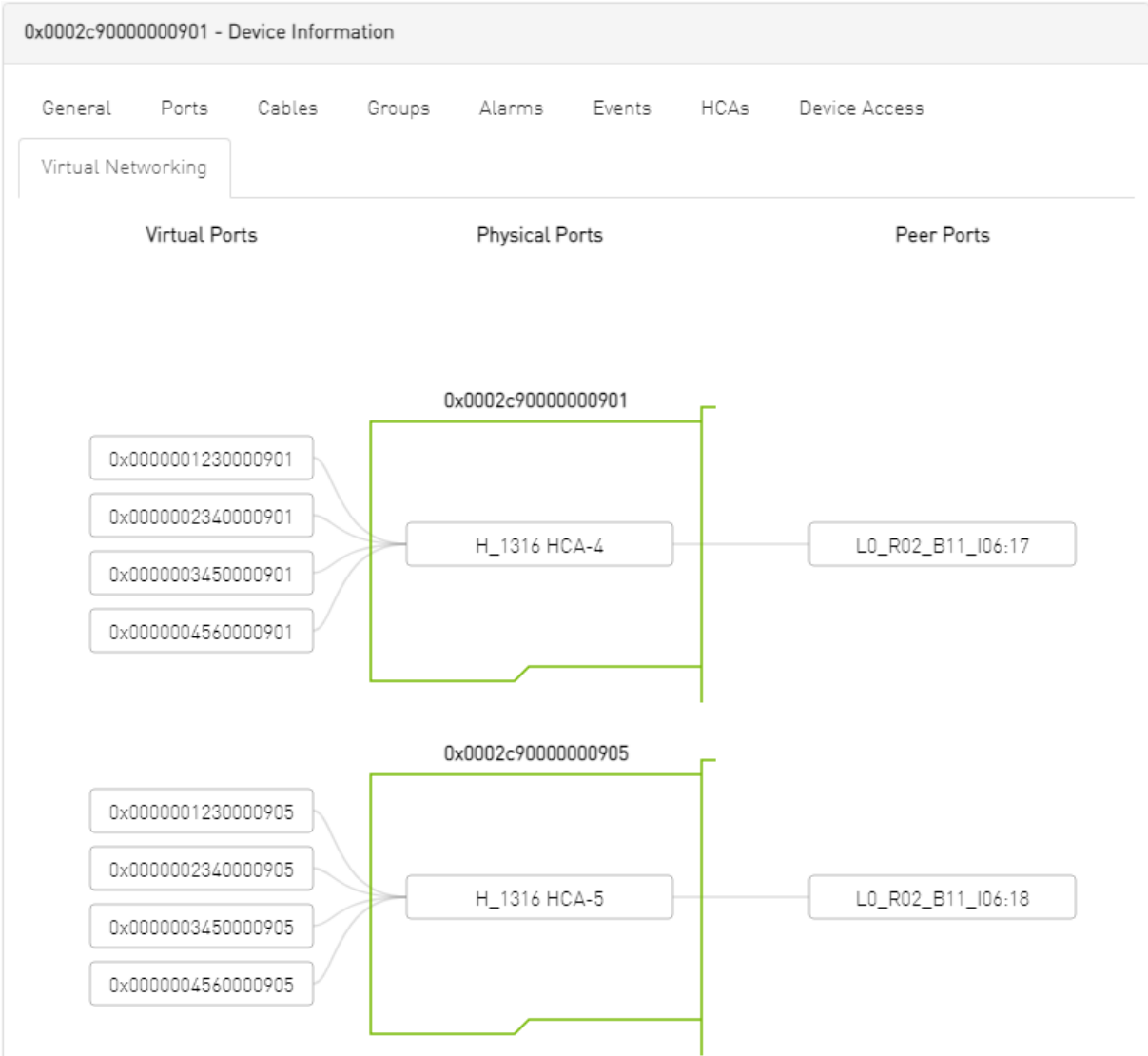

9.3.2 Ports Window

Provides a list of all ports in UFM.

All Ports High BER Ports

Active Displayed Columns CSV

Severity	State	System	Name	P. Name	LID	Peer Node	Name	Peer Name	Peer LID	MTU	Speed	Width
Warning	✓	r-hyp-sw-01	1	9	r-ufm254-hyp-01	HCA-1/1	1	4096	SDR	4X		
Info	✓	r-hyp-sw-01	23	9	ufm-host86	HCA-1/1	3	4096	EDR	4X		
Minor	✓	r-hyp-sw-01	36	9	SwitchIB Mellanox Technologies	36	2	4096	FDR	EDR	4X	
Info	✓	r-ufm254-hyp-01	HCA-1/1	1	r-hyp-sw-01	1	9	4096	SDR	EDR	4X	
Info	✓	r-ufm254-hyp-02	HCA-1/1	10	SwitchIB Mellanox Technologies	1	2	4096	FDR	EDR	4X	
Minor	✓	SwitchIB Mellanox Technologies	1	2	r-ufm254-hyp-02	HCA-1/1	10	4096	FDR	EDR	4X	
Info	✓	SwitchIB Mellanox Technologies	36	2	r-hyp-sw-01	36	9	4096	FDR	EDR	4X	
Info	✓	ufm-host86	HCA-1/1	3	r-hyp-sw-01	23	9	4096	EDR	4X		

Viewing 1-8 of 8

The table can be filtered by port state. The filter contains two options:

- Active - only active ports

- All - all ports

Severity	State	System	Name	P. Name	LID	Peer Node	Name	Peer ...	Peer LID	MTU	Speed	Width
Warning	✓	r-hyp-sw-01	1	9	r-ufm254-hyp-01	HCA-1/1	1	4096	SDR	EDR	4X	
Info	✓	r-hyp-sw-01	23	9	ufm-host86	HCA-1/1	3	4096	EDR	EDR	4X	
Minor	✓	r-hyp-sw-01	36	9	SwitchIB Mellanox Technologies	36	2	4096	FDR	EDR	4X	
Info	✓	r-ufm254-hyp-01	HCA-1/1	1	r-hyp-sw-01	1	9	4096	SDR	EDR	4X	
Info	✓	r-ufm254-hyp-02	HCA-1/1	10	SwitchIB Mellanox Technologies	1	2	4096	FDR	EDR	4X	
Minor	✓	SwitchIB Mellanox Technologies	1	2	r-ufm254-hyp-02	HCA-1/1	10	4096	FDR	EDR	4X	
Info	✓	SwitchIB Mellanox Technologies	36	2	r-hyp-sw-01	36	9	4096	FDR	EDR	4X	
Info	✓	ufm-host86	HCA-1/1	3	r-hyp-sw-01	23	9	4096	EDR	EDR	4X	

When right-clicking one of the available ports, the following actions appear:

Severity	State	System	Name	P. Name	LID	Peer Node	Name	Peer ...	Peer LID	MTU	Speed	Width
Warning	✓	r-hyp-sw-01	1	9	r-ufm254-hyp-01	HCA-1/1	1	4096	SDR	EDR	4X	
Info	✓	r-hyp-sw-01	23	9	ufm-host86	HCA-1/1	3	4096	EDR	EDR	4X	
Minor	✓	r-hyp-sw-01	36	9	SwitchIB Mellanox Technologies	36	2	4096	FDR	EDR	4X	
Info	✓	r-ufm254-hyp-01	HCA-1/1	1	r-hyp-sw-01	1	9	4096	SDR	EDR	4X	
Info	✓	r-ufm254-hyp-02	HCA-1/1	10	SwitchIB Mellanox Technologies	1	2	4096	FDR	EDR	4X	
Minor	✓	SwitchIB Mellanox Technologies	1	2	r-ufm254-hyp-02	HCA-1/1	10	4096	FDR	EDR	4X	
Info	✓	SwitchIB Mellanox Technologies	36	2	r-hyp-sw-01	36	9	4096	FDR	EDR	4X	
Info	✓	ufm-host86	HCA-1/1	3	r-hyp-sw-01	23	9	4096	EDR	EDR	4X	

All enable/disable actions on managed switches' ports are persistent. Thus, if a managed switch port is disabled, the port remains disabled even when rebooting the switch.

Clicking "Cable Information" opens up a window which provides data on operational, module, and troubleshooting information as shown in the following:

Cable Information - 7cfe900300f73be0_1

Operational Info Module Info Troubleshooting Info

Property	Value
Group Opcode	N/A
Recommendation	No issue was observed.
Status Opcode	0

Cable Information - 7cfe900300f73be0_1

Operational Info | **Module Info** | Troubleshooting Info

Property	Value
Vendor Serial Number	MT1515VS07837
Vendor Part Number	MCP1600-E001
Vendor Name	Mellanox
Attenuation (5g,7g,12g) [dB]	4,5,9
Bias Current [mA]	N/A
Cable Technology	Copper cable unequalized
Cable Type	Passive copper cable
CDR RX	N/A
CDR TX	N/A
Compliance	N/A
Digital Diagnostic Monitoring	No
FW Version	N/A
Identifier	QSFP+
LOS Alarm	N/A
OUI	Mellanox
Power Class	1.5 W max
Rev	A2
Rx Power Current [dBm]	N/A
Temperature [C]	N/A
Transfer Distance [m]	1
Tx Power Current [dBm]	N/A
Voltage [mV]	N/A
Wavelength [nm]	N/A

Cable Information - 7cfe900300f73be0_1

Operational Info | **Module Info** | Troubleshooting Info

Property	Value
Auto Negotiation	ON
FEC	Standard LL RS-FEC - RS(271,257)
Loopback Mode	No Loopback
Physical state	LinkUp
Speed	IB-EDR
State	Active
Width	0x
Enabled Link Speed	0x0000003f (EDR,FDR,FDR10,QDR,DDR,SDR)
Supported Cable Speed	0x0000003f (EDR,FDR,FDR10,QDR,DDR,SDR)

9.3.2.1 Physical Grade and Eye Opening Information

Eye opening information contains the following data:

- Physical Grade: [Grade0, Grade1, Grade2, Grade3]
- Height Eye Opening [mV]: [Height0, Height1, Height2, Height3]
- Phase Eye Opening [psec]: [Phase0, Phase1, Phase2, Phase3]

A new tab called Eye Information was added under cable information modal in ports table.

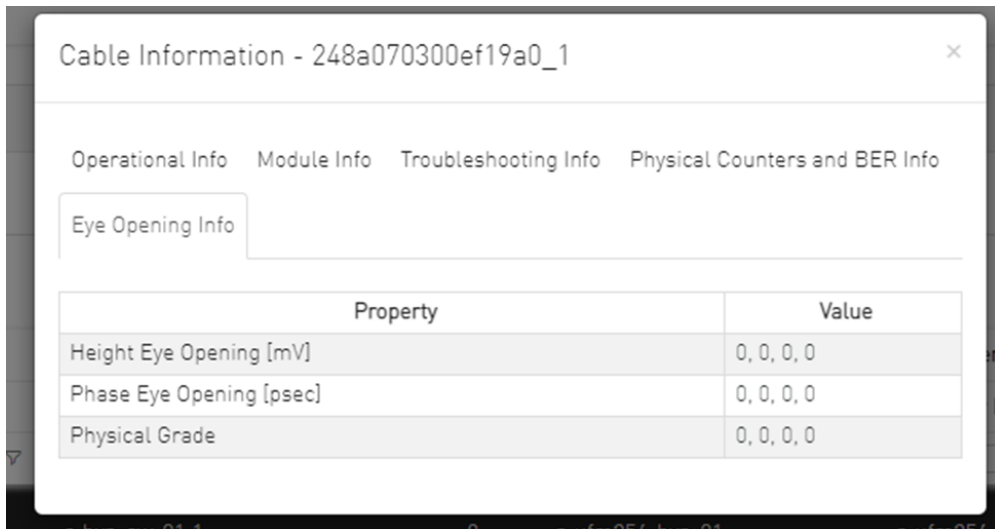

9.3.2.2 Auto-isolation of High-BER Ports

The High BER Ports tab lists all high-BER ports in the fabric.

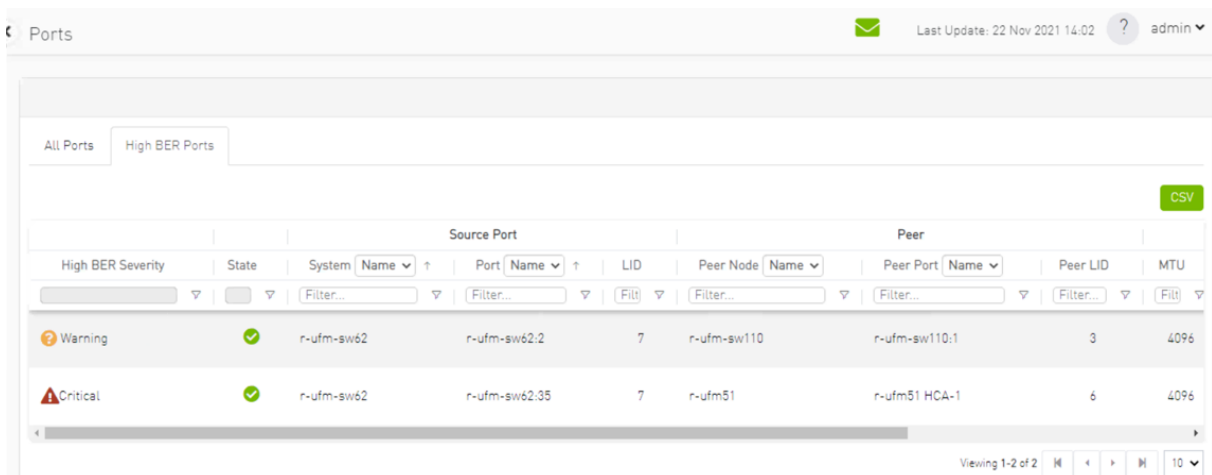

The flags `high_ber_ports_auto_isolation` must be configured in the `gv.cfg` file to enable this feature.

For each port discovered as a high-BER port, a new event is triggered in the Events table.

Marking the high-BER port as unhealthy suppresses all events and notifications related to the auto-isolated port.

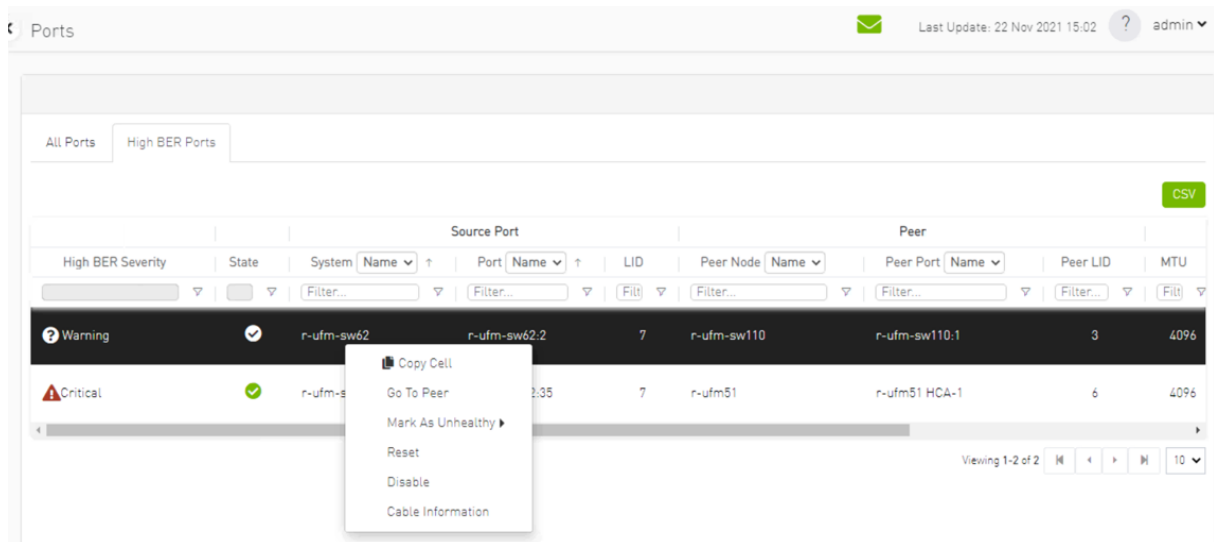

9.3.3 Virtual Ports Window

This page is only available if [Virtualization is enabled in gy.cfg](#).

Provides a list of all virtual ports in UFM.

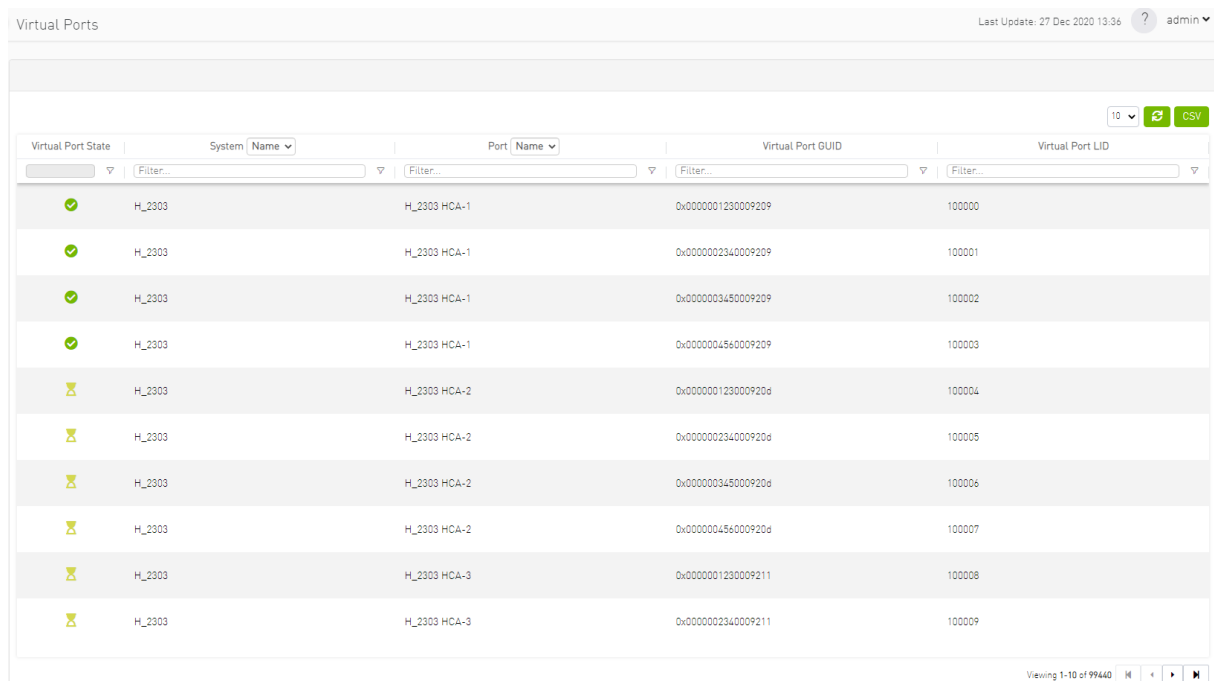

Right-clicking a virtual port allows navigation to the physical port mapped it is mapped to.

Virtual Port State	System Name	Port Name	Virtual Port GUID	Virtual Port LID
✓	H_2303	H_2303 HCA-1	0x0000001230009209	100000
✓	H_2303	H_2303 HCA-1	0x0000002340009209	100001
✓	H_2303	H_2303 HCA-1	0x0000003450009209	100002
✓	H_2303	H_2303 HCA-1	0x0000004560009209	100003

Clicking "Go to port" navigates to the [Virtual Networking tab](#) of the Device Information screen.

9.3.4 Unhealthy Ports Window

The Unhealthy Ports view shows all the unhealthy nodes in the fabric and the OpenSM health policy of the healthy/unhealthy nodes.

After the Subnet Manager examines the behavior of subnet nodes (switches and hosts) and discovers that a node is “unhealthy” according to the conditions specified below, the node is displayed in the Unhealthy Ports window. Once a node is declared as “unhealthy”, Subnet Manager can either ignore, report, isolate or disable the node. The user is provided with the ability to control the actions performed and the phenomena that declares a node “unhealthy.” Moreover, the user can “clear” nodes that were previously marked as “unhealthy.”

The information is displayed in a tabular form and includes the unhealthy port’s state, source node, source port, source port GUID, peer node, peer port, peer GUID, peer LID, condition, and status time.

Severity	Node	Port	GUID	Name	Port	GUID	LID	Condition	Status Time
Info	smg-ib-sv012	smg-ib-sv012.2	0x043720300695c6	smg-ib-sv040	smg-ib-sv040-39	0x0437203006818a0	33	FLAPPING	Thu Apr 28 14:04:08 2...
Minor	smg-ib-sv012	smg-ib-sv012.40	0x043720300695c6	smg-ib-sv022	smg-ib-sv022-36	0x7cfe900300fa05b0	39	FLAPPING	Thu Apr 28 14:10:11 2...
Warning	smg-ib-sv012	smg-ib-sv012.16	0x043720300695c6	smg-ib-sv056	smg-ib-sv056-1/30/1/1	0x900a84000040c840	12	FLAPPING	Thu Apr 28 14:10:11 2...
Warning	smg-ib-sv012	smg-ib-sv012.31	0x043720300695c6	smg-ib-api022-gen3	smg-ib-api022-gen3...	0x8039b03009fcd6e	53	FLAPPING	Thu Apr 28 14:10:11 2...
Warning	smg-ib-sv012	smg-ib-sv012.32	0x043720300695c6	smg-ib-api022-gen3	smg-ib-api022-gen3...	0x8039b03009fcd6f	54	FLAPPING	Thu Apr 28 14:10:11 2...
Warning	smg-ib-sv012	smg-ib-sv012.26	0x043720300695c6	smg-ib-vrt003	smg-ib-vrt003 HCA-1	0x8039b03009fcd6e	14	FLAPPING	Thu Apr 28 14:10:11 2...
Warning	smg-ib-sv012	smg-ib-sv012.33	0x043720300695c6	smg-ib-api021-gen3	smg-ib-api021-gen3...	0xb859903005681a0	1	FLAPPING	Thu Apr 28 14:10:11 2...
Warning	smg-ib-sv012	smg-ib-sv012.34	0x043720300695c6	smg-ib-api021-gen3	smg-ib-api021-gen3...	0xb859903005681a1	35	FLAPPING	Thu Apr 28 14:10:11 2...
Warning	smg-ib-sv012	smg-ib-sv012.29	0x043720300695c6	smg-ib-sv036	smg-ib-sv036-33/1	0xb8ce66000604afe	56	FLAPPING	Thu Apr 28 14:10:11 2...

The feature requires OpenSM parameter `hm_unhealthy_ports_checks` to be set to `TRUE` (default).

This feature is not available in the "Monitoring Only Mode."

The following are the conditions that would declare a node as "unhealthy":

- Reboot - If a node was rebooted more than 10 times during last 900 seconds
- Flapping - If several links of the node found in Initializing state in 5 out of 10 previous sweeps
- Unresponsive - A port that does not respond to one of the SMPs and the MAD status is TIMEOUT in 5 out of 7 previous SM sweeps
- Noisy Node - If a node sends traps 129, 130 or 131 more than 250 traps with interval of less than 60 seconds between each two traps
- Seterr - If a node respond with bad status upon SET SMPs (PortInfo, SwitchInfo, VLArb, SL2VL or Pkeys)
- Illegal - If illegal MAD fields are discovered after a check for MADs/fields during `receive_process`
- Manual - Upon user request mark the node as unhealthy/healthy
- Link Level Retransmission (LLR) - Activated when retransmission-per-second counter exceeds its threshold

All conditions except LLR generate Unhealthy port event, LLR generates a High Data retransmission event.

➤ To clear a node from the Unhealthy Ports Tab, do the following:

1. Go to the Unhealthy Ports window under Managed Elements.
2. From the Unhealthy Ports table, right click the desired port it and mark it as healthy.

Severity	Node	Port	GUID	Name	Port	GUID	LID	Condition	Status Time
Info	smg-ib-sw012	smg-ib-sw012.2	0x043f720300d695cc	smg-ib-sw040	smg-ib-sw040.39	0x043f720300d695cc	33	FLAPPING	Thu Apr 28 14:04:08.2...
Minor	smg-ib-sw012	smg-ib-sw012.40	0x043f720300d695cc	smg-ib-sw012	smg-ib-sw012.36	0x7c1ef003009a0b80	39	FLAPPING	Thu Apr 28 14:10:11.2...
Warning	smg-ib-sw012	smg-ib-sw012.16	0x043f720300d695cc	smg-ib-sw012	1/307/1/1	0x900a84030040c840	12	FLAPPING	Thu Apr 28 14:10:11.2...
Warning	smg-ib-sw012	smg-ib-sw012.31	0x043f720300d695cc	smg-ib-sw012	gen3 ...	0x98039a03009fcdce	53	FLAPPING	Thu Apr 28 14:10:11.2...
Warning	smg-ib-sw012	smg-ib-sw012.32	0x043f720300d695cc	smg-ib-sw012	gen3 ...	0x98039a03009fcdce	54	FLAPPING	Thu Apr 28 14:10:11.2...

➤ To mark a node as permanently healthy, do the following:

1. Open the `/opt/ufm/files/conf/health-policy.conf.user_ext` file.
2. Enter the node and the port information and set it as "Healthy."
3. Run the `/opt/ufm/scripts/sync_hm_port_health_policy_conf.sh` script.

To control Partial Switch ASIC Failure event:

Trigger Partial Switch ASIC Failure whenever number of unhealthy ports exceed the defined percent of the total number of the switch ports.

The switch_asic_fault_threshold flag (under the UnhealthyPorts section in gv.cfg file) default value is 20.

9.3.4.1 Unhealthy Port Connectivity Filter

It is possible to filter the Unhealthy Ports table by connectivity (all, host-to-switch, or switch-to-host).

Filtering the Unhealthy Ports table is possible from the dropdown options at the top of the table which includes

- All Connectivity
- Switch to Switch
- Host to Switch

Severity	Node	Port	GUID	Name	Port	Peer	LID	Condition	Status Time
Info	smg-lb-svw012	smg-lb-svw012.2	0x043720300695c6	smg-lb-svw040	smg-lb-svw040.39	0x0437203006818a0	33	FLAPPING	Thu Apr 28 14:04:08.2...
Minor	smg-lb-svw012	smg-lb-svw012.40	0x043720300695c6	smg-lb-svw022	smg-lb-svw022.36	0x7cfe70030007a0560	39	FLAPPING	Thu Apr 28 14:10:11.2...
Warning	smg-lb-svw012	smg-lb-svw012.16	0x043720300695c6	smg-lb-svw056	smg-lb-svw056.1/30/1/1	0x900a84030040c840	12	FLAPPING	Thu Apr 28 14:10:11.2...
Warning	smg-lb-svw012	smg-lb-svw012.31	0x043720300695c6	smg-lb-apl022-gen3	smg-lb-apl022-gen3...	0x98039b03009fcdce	53	FLAPPING	Thu Apr 28 14:10:11.2...
Warning	smg-lb-svw012	smg-lb-svw012.32	0x043720300695c6	smg-lb-apl022-gen3	smg-lb-apl022-gen3...	0x98039b03009fcdce	54	FLAPPING	Thu Apr 28 14:10:11.2...
Warning	smg-lb-svw012	smg-lb-svw012.26	0x043720300695c6	smg-lb-vrt003	smg-lb-vrt003.HCA-1	0x98039b03009fcdce	14	FLAPPING	Thu Apr 28 14:10:11.2...
Warning	smg-lb-svw012	smg-lb-svw012.33	0x043720300695c6	smg-lb-apl021-gen3	smg-lb-apl021-gen3...	0xb8599d03005681a0	1	FLAPPING	Thu Apr 28 14:10:11.2...
Warning	smg-lb-svw012	smg-lb-svw012.34	0x043720300695c6	smg-lb-apl021-gen3	smg-lb-apl021-gen3...	0xb8599d03005681a0	35	FLAPPING	Thu Apr 28 14:10:11.2...
Warning	smg-lb-svw012	smg-lb-svw012.29	0x043720300695c6	smg-lb-svw036	smg-lb-svw036.33/1	0xb8ceef0300604afe	56	FLAPPING	Thu Apr 28 14:10:11.2...

9.3.4.2 Health Policy Management

This view manages the OpenSM health policy for the healthy/unhealthy nodes and ports. The OpenSM health policy is stored in the /opt/ufm/files/conf/opensm/opensm-health-policy.conf file.

The information is displayed in a tabular form, with an option to group it either by devices or ports, and includes the health nodes/ports details (GUID, Name, policy [healthy/unhealthy])

1. Health Policy by devices:

Node GUID	Node Name	# of policies
0xecd9fa0300290ba0	switch1b	1
0x7cfe70030007a0560	sharp2	1

2. Health Policy by ports:

Node GUID	Node Name	Port	Policy	Action	Last Update
0xec09fa030029b9a0	switch-b	11	UNHEALTHY	isolate	Wed Jul 26 15:17:49 2023
0x7cfe9003005a2a0	sharp2	38	UNHEALTHY	isolate	Wed Jul 26 15:18:03 2023

To switch between the above views, simply click on the control button located at the top right corner of the table. By default, the devices view will be shown.

The health policy supports the following capabilities. When you select a policy and right-click, you can perform the following actions:

1. Delete the Policy
2. Mark the selected healthy policies as unhealthy (Isolate/No discover)
3. Mark the selected unhealthy policies as healthy

If you wish to delete all the healthy ports from the health policy, click on the 'Delete All Healthy Ports' option situated at the top right corner of the policy table.

9.3.5 Cables Window

Provides a list of all cables in UFM. For more information, see [Device's Cables Tab](#).

Severity	Serial #	Identifier	GUID	Port	Revision	Link Wi...	Part #	Techno...	Firmwa...	Length
Info	MT1618VS...	QSFP+	0x248a070300ef19a0	r-hyp-sw-01:1	A3	4X	MC220713...	Copper ca...		1 m
Info	MT1544VS...	QSFP+	0x248a070300ef19a0	r-hyp-sw-01:23	A2	4X	MCP1600-...	Copper ca...		2 m
Minor	MT1233VS...	QSFP+	0x248a070300ef19a0	r-hyp-sw-01:36	A3	4X	MC220713...	Copper ca...		2 m
Minor			0xe41d2a030003e3b0	SwitchIB Mellanox Technologies:36		4X				
Warning	MT1544VS...	QSFP+	0x7cfe900300292356	ufm-host86 mxb5_0	A2	4X	MCP1600-...	Copper ca...		2 m
Info	MT1618VS...	QSFP+	0x0c42a103007ab890	r-ufm254-hyp-01 mxb5_0	A3	4X	MC220713...	Copper ca...		1 m

Right-clicking a cable from the list allows users to Collect System Dump for the endpoints of the link and navigate to peer port.

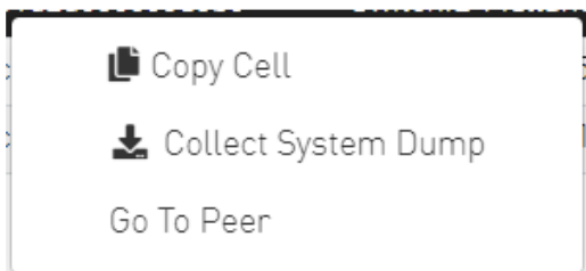

9.3.6 Groups Window

The Groups window allows users to create new groups of devices and provides information about existing groups.

All predefined groups have Read permissions only, except Suppressed_Devices to/from which the user is also able to add/remove members or devices.

The following predefined groups auto-populate upon UFM startup: Switches, 1U_Switches, Modular_Switches, Gateway_Devices, and Hosts.

➤ To create a group of devices, do the following:

1. Click “New” under “Groups.”

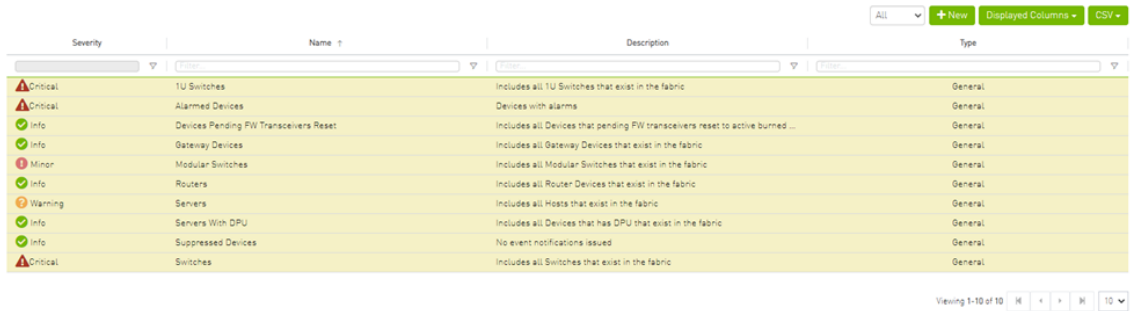

The screenshot shows a table of predefined groups in the UFM interface. The table has columns for Severity, Name, Description, and Type. The rows list various device groups with their respective severities and descriptions.

Severity	Name	Description	Type
Critical	1U Switches	Includes all 1U Switches that exist in the fabric	General
Critical	Alarmed Devices	Devices with alarms	General
Info	Devices Pending F/W Transceivers Reset	Includes all Devices that pending F/W transceivers reset to active burned ...	General
Info	Gateway Devices	Includes all Gateway Devices that exist in the fabric	General
Minor	Modular Switches	Includes all Modular Switches that exist in the fabric	General
Info	Routers	Includes all Router Devices that exist in the fabric	General
Warning	Servers	Includes all Hosts that exist in the fabric	General
Info	Servers With DPU	Includes all Devices that has DPU that exist in the fabric	General
Info	Suppressed Devices	No event notifications issued	General
Critical	Switches	Includes all Switches that exist in the fabric	General

2. In the New Group wizard, fill in the required information under the General tab: Name (must be between 4-20 characters), Type (General/Rack/Port), and Description (optional), and click Next.

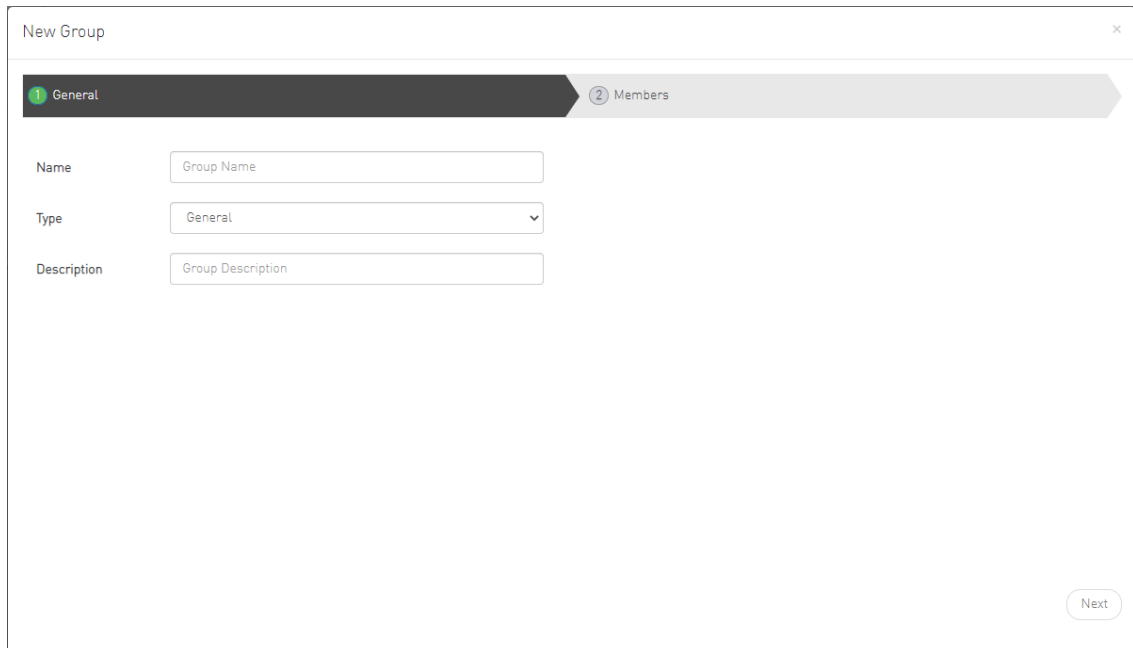

The screenshot shows the 'New Group' wizard in the UFM interface. The 'General' tab is selected, and the 'Members' tab is also visible. The form fields are as follows:

- Name: Group Name
- Type: General
- Description: Group Description

A 'Next' button is located at the bottom right of the form.

3. Under Members tab, move the members of the new group from the Available list to the Selected list.

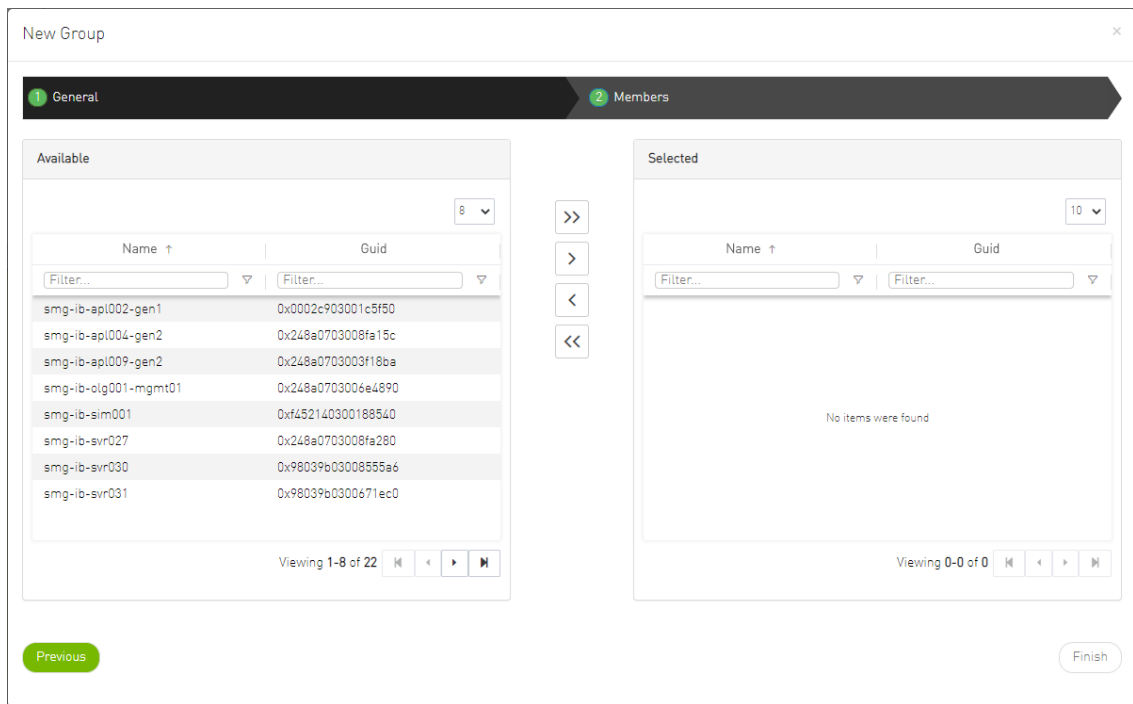

4. Click “Finish” and the new group will appear under the Groups window.

Group members details - port’s hostname, port’s GUID, and device’s IP address - can be viewed when selecting the group from the list of all groups available.

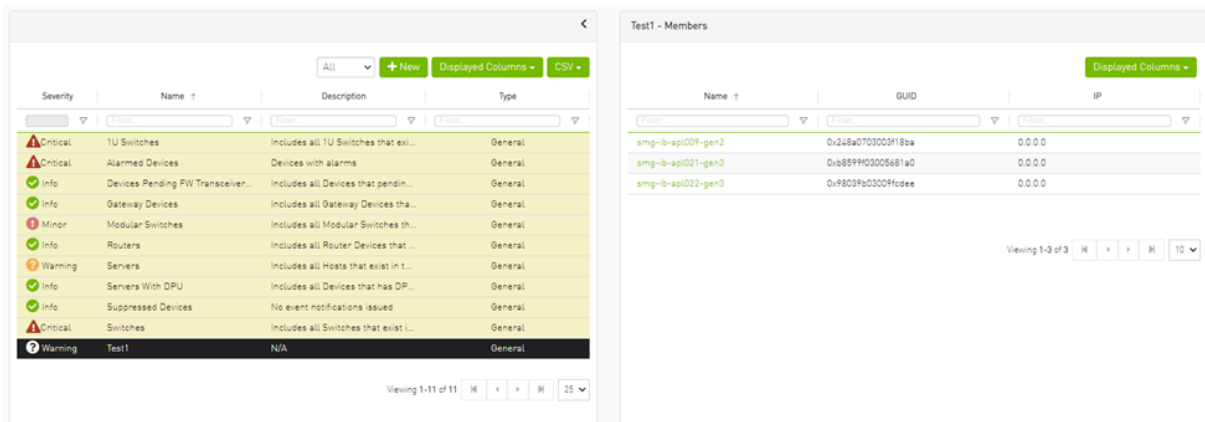

Group Actions

Right-clicking a group enables performing the following actions:

- Edit - groups can be modified either by editing the group description under General tab, or substituting group members under Members tab
 - Delete - existing groups can be deleted from the list
 - **Remove All Members** - all members of an existing group can be removed at once
 - Collect System Dump - sysdump may be generated for all members of an existing group
- The user can filter group by type (General, Rack, Super Switch and Port)

Severity	Name ↑	Description	Type
Minor	1U Switches	Includes all 1U Switches that	General
Minor	Alarmed Devices	Devices with alarms	General
Minor	Devices Pending FW Transceivers Reset	Includes all Devices that pending FW transe...	General
Info	Gateway Devices	Includes all Gateway Devices that exist in the...	General
Info	Modular Switches	Includes all Modular Switches that exist in th...	General
Info	Routers	Includes all Router Devices that exist in the f...	General
Minor	Servers	Includes all Hosts that exist in the fabric	General
Info	Servers With DPU	Includes all Devices that has DPU that exist i...	General
Info	Suppressed Devices	No event notifications issued	General
Minor	Switches	Includes all Switches that exist in the fabric	General

Viewing 1-10 of 10

9.3.7 Inventory Window

Provides a list of all modules in UFM. For more information, see [Device's Inventory Tab](#).

Severity	Status	Serial Number	System Name	Description	Type	Software Version	Part Number	Hardware Revision	Power
Info	OK	MT2019711521	zoo-um-gm01	SYSTEM	SYSTEM	3.11.2016-R6L24	MQM870L-H52F	A2	
Info	OK	MT2019711521	zoo-um-gm01	MSMT - 1	MSMT		MQM870L-H52F	A2	
Info	OK	zoo-um-gm01	zoo-um-gm01	FAN - 1	FAN				
Info	OK	zoo-um-gm01	zoo-um-gm01	FAN - 3	FAN				
Info	OK	zoo-um-gm01	zoo-um-gm01	FAN - 2	FAN				
Info	OK	zoo-um-gm01	zoo-um-gm01	FAN - 5	FAN				
Info	OK	zoo-um-gm01	zoo-um-gm01	FAN - 4	FAN				
Info	OK	zoo-um-gm01	zoo-um-gm01	FAN - 6	FAN				
Info	OK	MT2019710901	zoo-um-gm01	PS - 2	PS		MTER-PSR-A2-C	A2	112.62
Warning	NAK	MT2019710902	zoo-um-gm01	PS - 1	PS		MTER-PSR-A2-C	A2	
Info	active		zoo-um-gm01	Aggregation Node (2a2a1030079a...	SHARP				
Info	active		um-gm-04	Aggregation Node (f028f1030086a3...	SHARP				

Viewing 1-12 of 12

9.3.8 PKeys Window

The PKeys window allows users to create new groups of ports and provides information about existing PKeys.

This window offers one predefined PKey (highlighted in the list of PKeys): Management key 0x7fff with Read permissions only.

For further information about InfiniBand partitioning (Pkeys management), please refer to the [Partitioning Appendix](#).

9.3.8.1 Creating New PKey

To create a PKey:

1. Click the “New” button under “PKeys”.
Please note that the yellow highlighted PKeys are predefined ones.

PKey	Partition	IP Over IB
0x7fff	management	✓
0x7ff	api_pkey_0x7ff	✓

2. In the New PKey wizard, fill in the required information under the General tab:
 - Name—must be between 0x1 and 0x7fff, inclusive
 - Index-0 attribute—True/False
 - IP Over IB attribute—True/False

New PKey

General Members

Pkey: 0x PKey Name

Index-0

IP Over IB

Next

3. Click “Next.”
4. Under Members tab, select the device of which ports you would like to group in one PKey, and move the members (ports) from the Available list to the Selected list. For each member (port) you may specify a membership type (Full/limited).

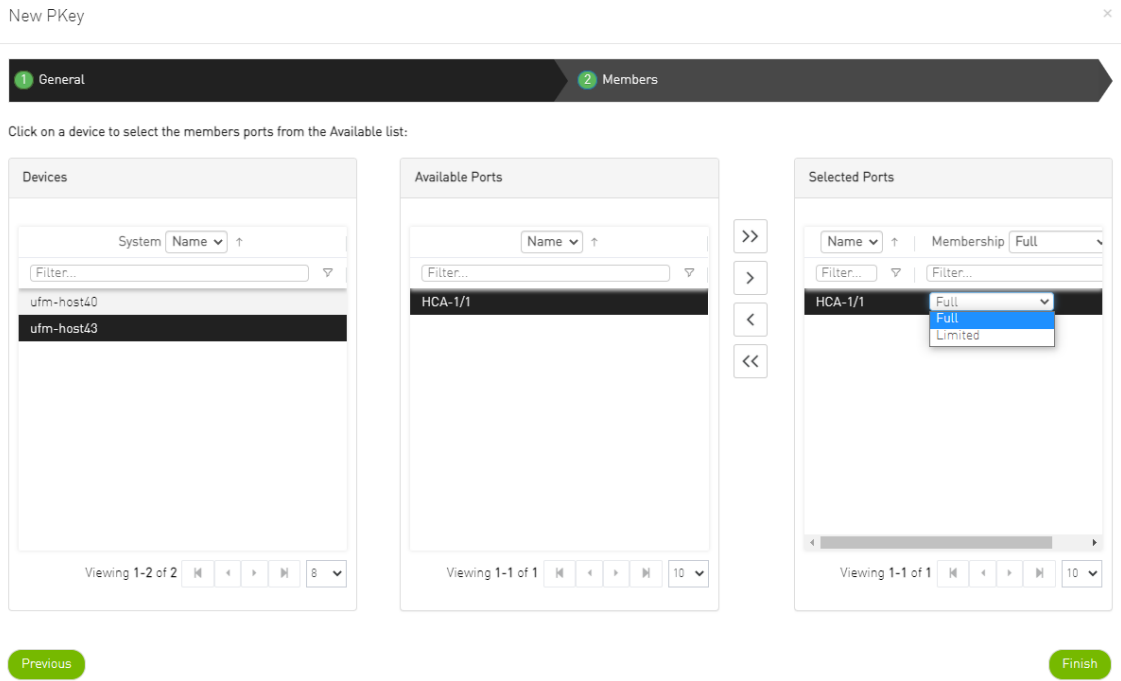

5. Click “Finish”. The new PKey will become available under the PKey window.

When selecting a PKey from the PKeys table, PKey Information table will appear on the right side of the screen. This table provides information on the PKey's members and QoS settings.

9.3.8.2 PKey Members Tab

Provides details on the PKey members: port's hostname (node), device's IP address, port GUID, port number, membership and index-0 attributes values.

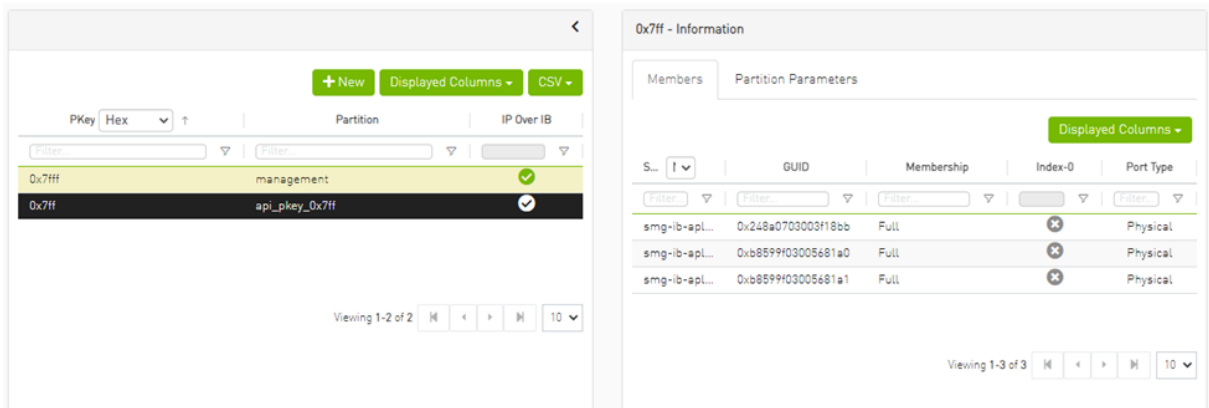

9.3.8.3 PKey QoS Tab

Displays the current partitioning parameter settings of the selected PKey: MTU Limit, Service Level and Rate limit. These settings can be modified by the user.

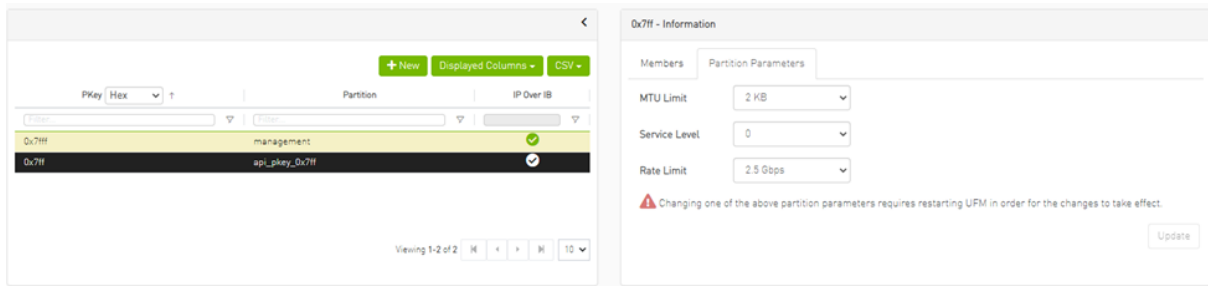

9.3.8.4 PKey Actions

Right-clicking one PKey from the list enables performing the following actions:

- **Modify Members** - PKeys can be modified either by editing the attributes under General tab, or updating the members under Members tab. Including updating ports memberships.
- **Remove** - existing PKeys can be deleted from the list.

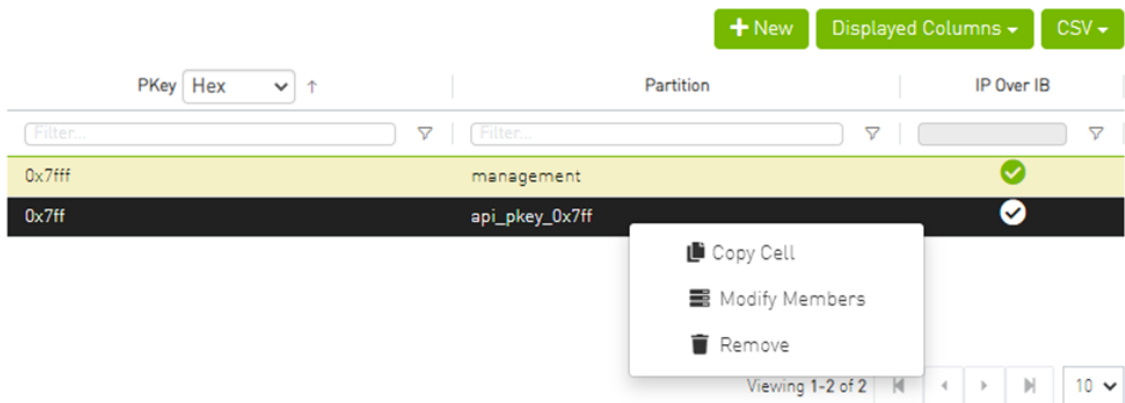

For information on partitioning, refer to [Appendix - Partitioning](#).

Note that restarting OpenSM is required for the QoS parameters change to take effect.

9.3.8.5 Support Pkey with Virtual Ports

Creating a pkey with virtual ports is supported, so pkey can contain the following types of port:

- Physical
- Virtual
- Both physical and virtual

The create new pkey wizard dropdown includes port types.

1 General 2 Members

Click on a device to select the members ports from the Available list:

Devices

System Name ↑

Filter...

- r-ufm254-hyp-03
- r-ufm254-hyp-04
- ufm-host87

Viewing 1-3 of 3

Available Ports Show: Physical

GUID ↑

Filter...

- 0x0c42a103007aca90

Viewing 1-1 of 1

Selected Ports

GUID ↑ Memb... Full

Filter... Filter...

No items were found

Viewing 0-0 of 0

Previous

Finish

1 General 2 Members

Click on a device to select the members ports from the Available list:

Devices

System Name ↑

Filter...

- r-ufm254-hyp-03
- r-ufm254-hyp-04
- ufm-host87

Viewing 1-3 of 3

Available Ports Show: Virtual

GUID ↑

Filter...

- 0x1122334477667700
- 0x1122334477667701
- 0x1122334477667710
- 0x1122334477667711

Viewing 1-4 of 4

Selected Ports

GUID ↑ Memb... Full

Filter... Filter...

No items were found

Viewing 0-0 of 0

Previous

Finish

1 General 2 Members

Click on a device to select the members ports from the Available list:

Devices

System Name ↑

Filter...

- r-ufm254-hyp-03
- r-ufm254-hyp-04
- ufm-host87

Viewing 1-3 of 3

Available Ports Show: Both ↓

GUID ↑

Filter...

- 0x0c42a103007aca90
- 0x1122334477667700
- 0x1122334477667701
- 0x1122334477667710
- 0x1122334477667711

Viewing 1-5 of 5

Selected Ports

GUID ↑ Memb... Full ↓

Filter... Filter...

No items were found

Viewing 0-0 of 0

Previous
Finish

9.3.9 HCAs Window

Provides a list of all the HCAs of the hosts in UFM. For more information, see section "[HCAs Tab](#)".

Severity	System	Name	GUID	Type	Port 1	Name	Port 2	Name	PSID	FW Version
Info	smg-lb-svr45		0xe0d9fa0300e9581c	ConnectX-5	smg-lb-svr45	HCA-3	smg-lb-svr45	HCA-4	MT_0000000008	16.32.566
Info	smg-lb-gw01-lb-gw		0x0c42a1030098b138	ConnectX-6	smg-lb-gw01-lb-gw	HCA-7	N/A	N/A	MT_0000000491	20.30.1004
Info	smg-lb-vm003		0x98039b03009fc16e	ConnectX-6	smg-lb-vm003	HCA-1	N/A	N/A	MT_0000000228	20.29.550
Info	smg-lb-svr036		0x7cfe9003000e8a54	ConnectX-4	smg-lb-svr036	HCA-1	smg-lb-svr036	HCA-2	MT_2190110032	12.28.2006
Info	smg-lb-sim001		0x10709d03000d6980	BlueField2	smg-lb-sim001	HCA-1	smg-lb-sim001	HCA-2	MT_0000000872	24.33.900
Info	smg-lb-svr027		0x248a07030008fa280	ConnectX-4	smg-lb-svr027	HCA-1	smg-lb-svr027	HCA-2	MT_2190110032	12.28.2006
Info	smg-lb-apl021-gen3		0xb8999f03005681a0	ConnectX-6	smg-lb-apl021-gen3	miu5_0	smg-lb-apl021-gen3	miu5_1	MT_0000000224	20.32.1010
Info	smg-lb-svr46		0xe0d9fa0300041ab2	ConnectX-5	smg-lb-svr46	HCA-3	N/A	N/A	MT_0000000010	16.32.566
Info	smg-lb-apl009-gen2		0x248a07030009f18ba	ConnectX-4	N/A	N/A	smg-lb-apl009-gen2	HCA-2	MT_2190110032	12.28.2006
Info	smg-lb-svr001		0x98039b03000671ec0	ConnectX-6	smg-lb-svr001	HCA-1	N/A	N/A	IBM0000000027	20.31.2006

Viewing 1-10 of 23

9.4 Events & Alarms

All information in a tabular format in UFM web UI can be exported into a CSV file.

UFM allows you to identify any problem, including ports and device connectivity, using events and alarms. Problems can be detected both before running applications and during standard operation.

Events trigger alarms (except for "normal" events. i.e., Info events) when they exceed a predefined threshold. Events and alarms can be configured under Events Policy tab under Settings window. For more information, refer to [Events Policy Tab](#).

Severity	Date/Time ↓	Alarm Name	Source	Source Type	Reason	Count
Warning	2024-07-28 9:07:54	Excessive Bu...	SubModule: Mellanox Technologic	IBPort	ExcessiveBufferOverrunErrors counter rate threshold exceeded. Thres...	1
Minor	2024-07-28 9:07:53	Port Xmit Dis...	SubModule: Mellanox Technologic	IBPort	PortXmitDiscards counter rate threshold exceeded. Threshold is 0 rec...	1
Minor	2024-07-28 9:07:52	Non-optimal ...	SubModule: Mellanox Technologic	IBPort	Found a 4x link that operates in 1x width mode.	1
Info	2024-07-28 9:07:51	VL15 Droppe...	SubModule: Mellanox Technologic	IBPort	VL15Dropped counter rate threshold exceeded. Threshold is 0, receive...	1
Minor	2024-07-28 9:07:49	Port Receive ...	SubModule: Mellanox Technologic	IBPort	PortRcvRemotePhysicalErrors counter rate threshold exceeded. Thres...	1
Warning	2024-07-28 9:07:47	GID Address ...	SubModule: Mellanox Technologic	IBPort	GID Address Out of Service: prefix ff12601bffff0000.guid 0xb8599f03000...	1
Minor	2024-07-28 9:06:29	Non-optimal ...	Switch: sw-hpc62 / 3	IBPort	Found a [25.0] link that operates in [14.0] speed mode.	6
Warning	2024-07-28 8:37:20	Topology co...	Topology compare report [2]	Site	Topology differences were detected in comparison to the master topol...	1

Severity	Date/Time ↓	Event Name	Source	Source Type	Description	Category
Warning	2024-07-28 9:07:54	Excessive Buffer Over...	default / SubModule: Mellanox Techn	IBPort	ExcessiveBufferOverrunErrors counter rate thresh...	
Minor	2024-07-28 9:07:53	Port Xmit Discards [***	default / SubModule: Mellanox Techn	IBPort	PortXmitDiscards counter rate threshold exceeded...	
Minor	2024-07-28 9:07:52	Non-optimal link widt...	default / SubModule: Mellanox Techn	IBPort	Found a 4x link that operates in 1x width mode.	
Info	2024-07-28 9:07:51	VL15 Dropped [*** Si...	default / SubModule: Mellanox Techn	IBPort	VL15Dropped counter rate threshold exceeded. Th...	
Minor	2024-07-28 9:07:49	Port Receive Remote ...	default / SubModule: Mellanox Techn	IBPort	PortRcvRemotePhysicalErrors counter rate thresh...	
Info	2024-07-28 9:07:48	New MCast Group Cre...	default / SubModule: Mellanox Techn	IBPort	New MCast group is created: ff12601bffff0000, 0xb...	
Warning	2024-07-28 9:07:47	GID Address Out of Se...	default / SubModule: Mellanox Techn	IBPort	GID Address Out of Service: prefix ff12601bffff0000...	
Info	2024-07-28 9:07:42	Topology compare Rep...	Topology compare report [67]	Site	The current topology aligns with the master topolo...	
Info	2024-07-28 9:07:22	Topology compare Rep...	Topology compare report [66]	Site	The current topology aligns with the master topolo...	
Info	2024-07-28 9:06:41	Topology compare Rep...	Topology compare report [65]	Site	The current topology aligns with the master topolo...	

Users can enable the events persistency mechanism from the `gv.cfg`. This allows the user to see the events in the case of restarting the UFM or in HA mode.

Alternatively you can run the following commands:

- `ufm events persistency enable`
- `ufm events max-restored`

The persistency is deactivated by default and can be enabled by the following controlled parameters in the config file:

- `max_restored_events = 50 #` - will determine the number of events to restore
- `events_persistency_enabled = true #` - will set to true for the feature to work

9.4.1 Device Status Events

The Device Status Events tab displays topology change events related to devices in a table. it will support the following event types:

- None is Up/Down
- Switch is Up/Down
- Director Switch is Up/Down

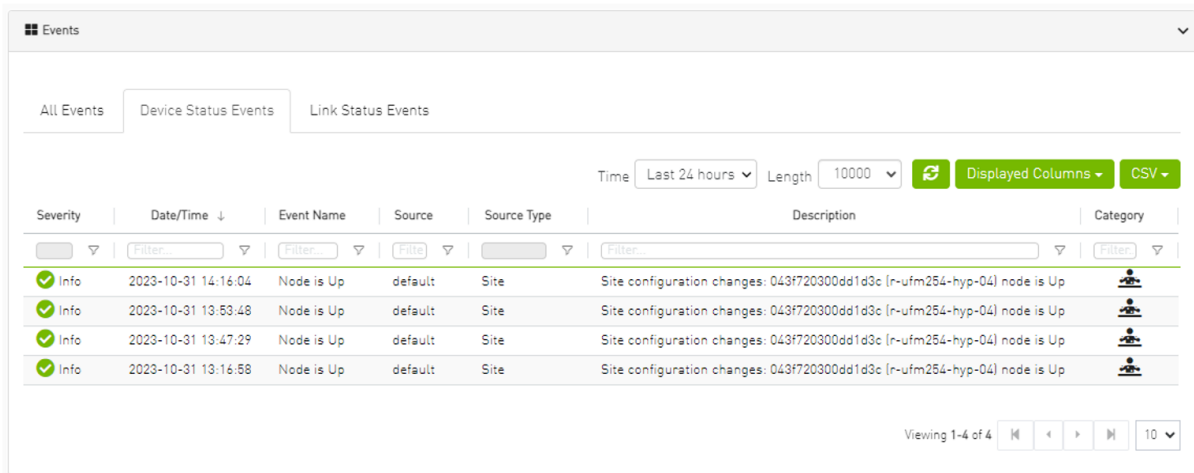

Filters are provided to allow events filtering by the desired time interval with a length limit.

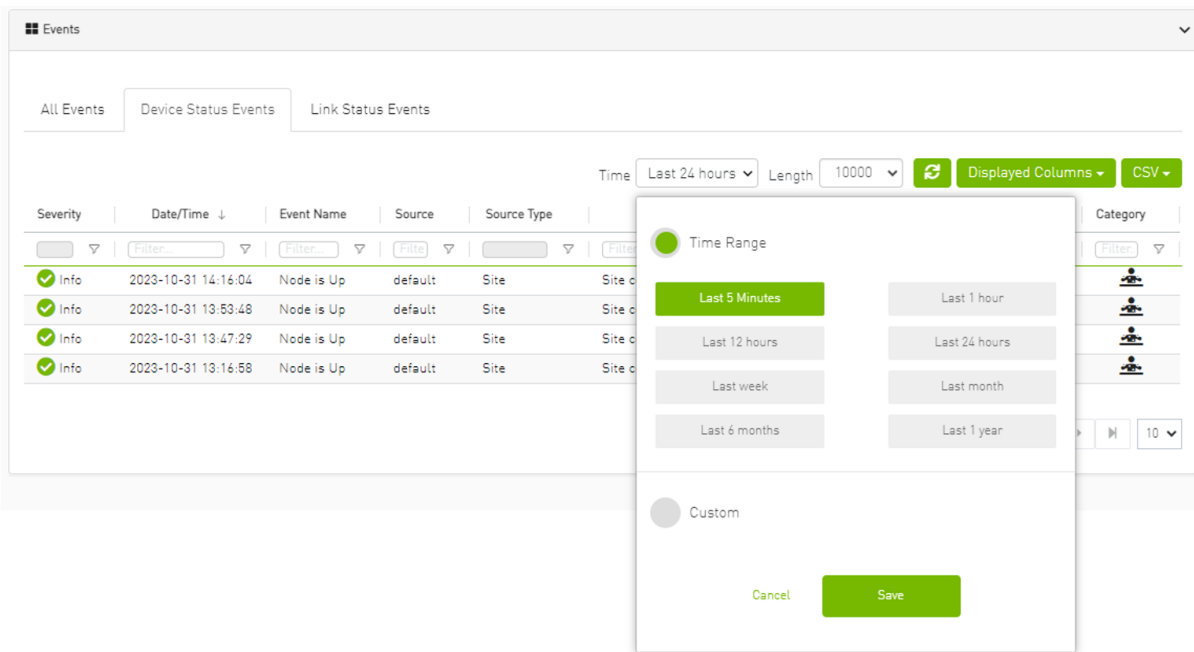

9.4.2 Link Status Events

The Link Status Events tab displays topology change events related to links in a table. It supports the following event type:

- Link is Up/Down

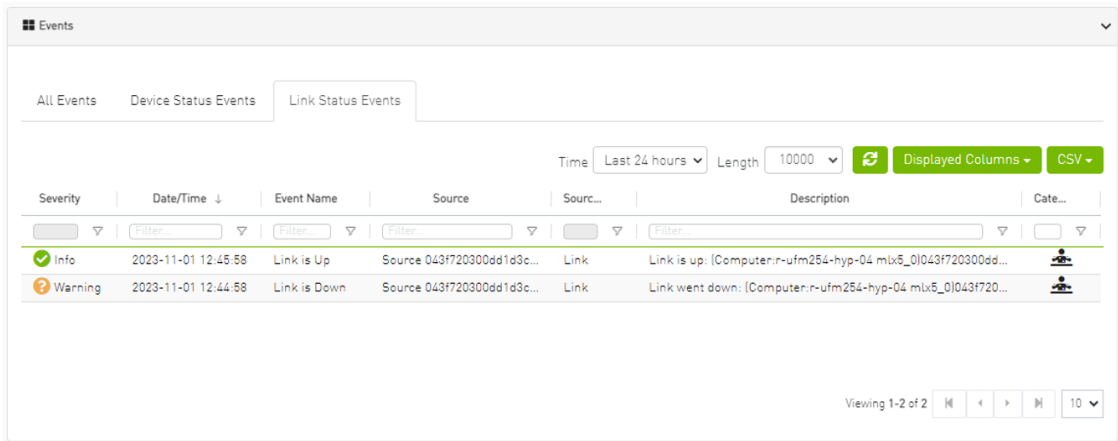

Filters are provided to allow filtering by the desired time interval in a time range.

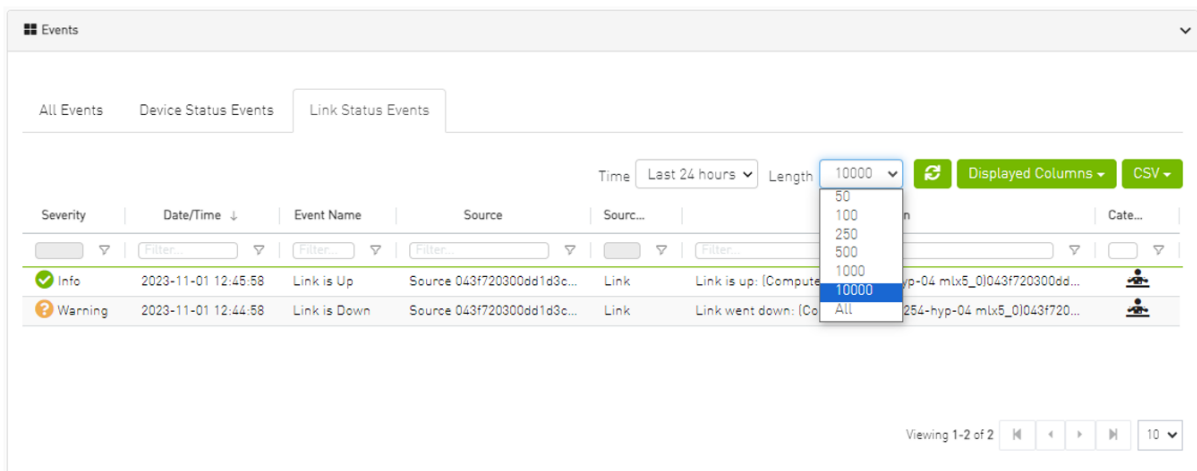
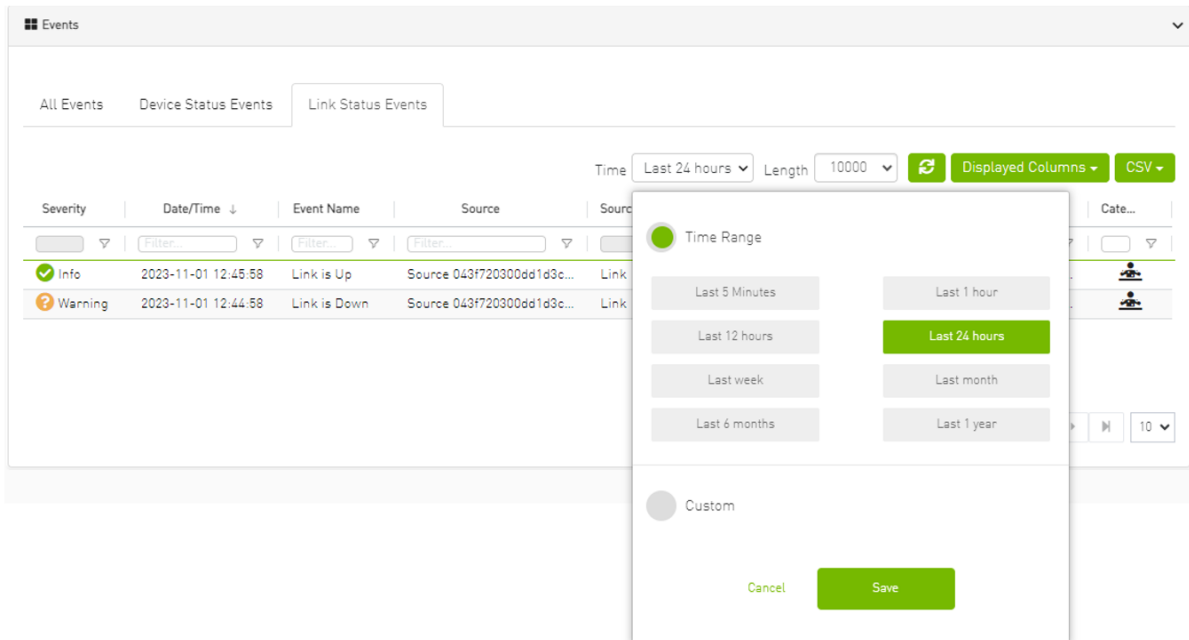

The related switch context menu is displayed only if the event type is 'Switch is Up/Down'. Other event types show the default context menu, which is 'Copy Cell'.

9.4.2.1 Cable Transceiver Temperatures

The UFM has alarms that notify the user in cases where an active cable overheats/overcools. The UFM uses ibdiagnet to get cable temperature analysis and report exceptions via the Alarms view.

Related events:

- 919 for high cable temperature
- 920 for low cable temperature

9.4.2.1.1 GUI Views

9.4.2.1.1.1 Events

Severity	Date/Time ↓	Event Name	Source	Source Type	Description	Category
Info	2024-07-28 9:21:23	Topology compare Rep...	Topology compare report [94]	Site	The current topology aligns with the master topolo...	
Warning	2024-07-28 9:20:43	Topology compare Rep...	Topology compare report [93]	Site	Topology differences were detected in comparison ...	

9.4.2.1.1.2 Alarms

Severity	Date/Time ↓	Alarm Name	Source	Source Type	Reason	Count
Warning	2024-07-28 9:20:43	Topology co...	Topology compare report [93]	Site	Topology differences were detected in comparison to the master topo...	1

9.4.2.1.1.3 Event Policy

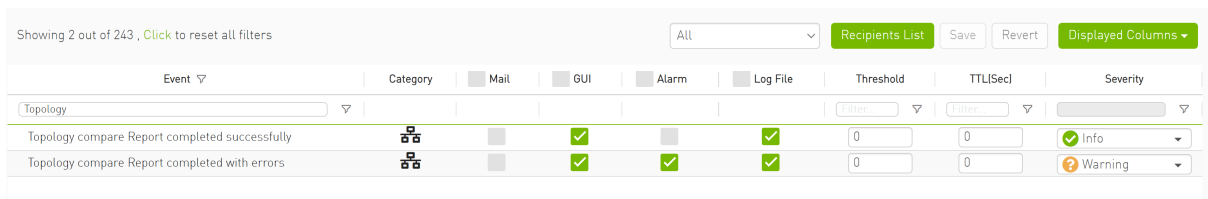

Showing 2 out of 243, Click to reset all filters

All Recipients List Save Revert Displayed Columns

Event	Category	Mail	GUI	Alarm	Log File	Threshold	TTLSec	Severity
Topology compare Report completed successfully		<input type="checkbox"/>	<input checked="" type="checkbox"/>	<input type="checkbox"/>	<input checked="" type="checkbox"/>	0	0	Info
Topology compare Report completed with errors		<input type="checkbox"/>	<input checked="" type="checkbox"/>	<input checked="" type="checkbox"/>	<input checked="" type="checkbox"/>	0	0	Warning

9.4.2.2 Topology Compare Events:

The UFM has alarms and events that notify the user of the result of periodic topology compare.

Related events:

- 1607 Topology compare Report completed successfully
- 1608 Topology compare Report completed with errors

9.5 Telemetry - User-Defined Sessions

Error: null

9.6 System Health

The System Health window enables running and viewing reports and logs for monitoring and analyzing UFM server and fabric health through the following tabs: UFM Health, UFM Logs, UFM Snapshot, Fabric Health, Daily Reports and Topology Compare.

- [UFM Health Tab](#)
- [UFM Logs Tab](#)
- [UFM System Dump Tab](#)
- [Fabric Health Tab](#)
- [Daily Reports Tab](#)
- [Topology Compare Tab](#)
- [Fabric Validation Tab](#)
- [IBDiagnet Tab](#)

9.6.1 UFM Health Tab

Through UFM Health tab, you can create reports that run a series of checks on the UFM server.

Each check that is run for a report triggers a corresponding event. Events are also triggered when a report starts and ends. For more information, see [Events & Alarms](#).

To run a new report, click “Run New Report”. Results will be displayed inline automatically.

System Health

UFM Health UFM Logs UFM Snapshot Fabric Health Daily Reports Topology Compare Fabric Validation IBDiagnet

UFM Health Report

Date 2020-10-11 17:21:00
Created By admin

Show Problems Only

✓ UFM Configuration	Completed Successfully. See details below >
✓ UFM Processes	Completed Successfully. See details below >
✓ Memory Monitoring	Completed Successfully. See details below >
✓ CPU Monitoring	Completed Successfully. See details below >
✓ Disk Monitoring	Completed Successfully. See details below >
✓ Fabric Interface	Completed Successfully. See details below >
✓ Core Dumps List	Completed Successfully. See details below >

You can expand the results of each check or expand the results of all checks at once by clicking the "Expand All" button.

To view only the errors of the report results, click the "Show Problems Only" checkbox.

The following tables describe the checks included in the report.

UFM Health Report Checks

UFM Configuration	
Check	Description
Release Number	UFM software version and build.
License Type	Type of license, permanent or evaluation.
License Customer Number	The customer number provided by NVIDIA.
License UID	The UFM serial number provided by NVIDIA.
License Expiration Date	License expiration date for limited licenses.
License Functionality	Level of functionality enabled for the end-user, standard or advanced.
License Devices Limit	The maximum number of devices that UFM is licensed to manage. Note that it displays the current active and valid UFM licenses (not the sum of all valid licenses devices)
Running Mode	UFM running mode, Standalone or High Availability (HA). When UFM is in HA mode, additional information is displayed for the master and standby servers.

UFM Processing	
Check	Description
OpenSM	Status of the OpenSM service.
ibpm	Status of the ibpm (Performance Manager) service.
ModelMain	Status of the main UFM service.
httpd	Status of the httpd service.
MySQL	Status of the MySQL service.

Memory Monitoring	
Check	Description
Total memory usage	Percentage of total memory usage.
UFM memory usage	Percentage of UFM memory usage

CPU Monitoring	
Check	Description
Total CPU Capacity	Percentage of CPU capacity available
CPUs Number	Number of CPUs
Total CPU utilization	Percentage of total CPU utilization.
UFM CPU utilization	Percentage of UFM CPU utilization.

Disk Monitoring	
Check	Description
Disk <diskname>	Percentage of disk usage.

Fabric Interface	
Check	Description
Fabric Interface	Name and state of fabric interface.

9.6.2 UFM Logs Tab

UFM logging records events and actions that can serve to identify fabric and UFM server issues and assist in troubleshooting.

The logs are categorized into three files according to the activities they record: Event logs, SM logs, and UFM logs.

To view the log files, select the desired log file from the drop-down menu. Log data will be displayed:

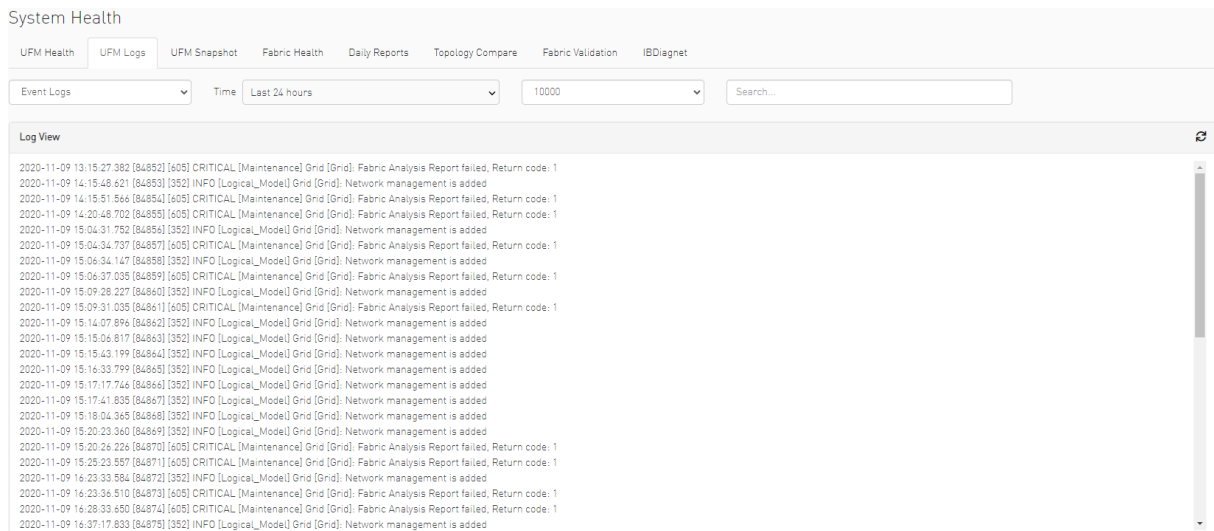

In the Logs window, you can do the following:

- Refresh the data using the Refresh button on the right-hand side of the screen
- Search for a specific value using the Search bar
- Limit the display to a specific time period using the Time drop-down menu
- Limit the display to a specific number of lines using the drop-down menu (use "All" option to display all lines)
- Control the display of log occurrences by either showing all lines or hiding the duplicated ones.

9.6.2.1 Event Logs

Event Logs show the history of fabric events detected and initiated by the UFM server. The timestamp and severity of an event is indicated as well as the cause of the event and additional relevant information. *The Event log is kept on the UFM server in the /opt/ufm/log/events.log file.* Events can be configured whether to appear in the log files under the Events Policy tab in the Settings window. For more information, see [Events Policy](#).

See "[Appendix - Supported Port Counters and Events](#)" for a comprehensive list of Events.

9.6.2.2 Subnet Manager (SM) Logs

SM Logs show messages of the Subnet Manager and communication plug-in.

The log verbosity is defined by selecting the Log Levels in the Subnet Manager tab under Settings window. For more information, see [Subnet Manager Tab](#).

9.6.2.3 UFM Logs

UFM Logs is a general log of UFM Server. The log saves a history of user actions, events, polling results and other server activities and errors. Log verbosity is defined on start-up in the configuration file /opt/ufm/conf/gv.cfg:

```
[Logging]
# optional logging levels
#CRITICAL, ERROR, WARNING, INFO, DEBUG
level = WARNING
```

The default verbosity level is WARNING.

9.6.3 UFM System Dump Tab

You can export and save UFM database information, configuration and log files in a predefined location allowing you to create full system dump before upgrading, or for NVIDIA Support.

By default and upon UFM bring up, the UFM creates an initial system dump. The system dump includes UFM database, UFM configuration, machine configuration and log files. You can also save troubleshooting information to send the required information for debugging with NVIDIA Enterprise Support. The additional troubleshooting information includes system snapshot files, system configurations and UFM reports.

To create a system dump, click the “Create System dump” button.

To extend the troubleshooting information for debugging purposes, check the "Include Troubleshooting" Information checkbox.

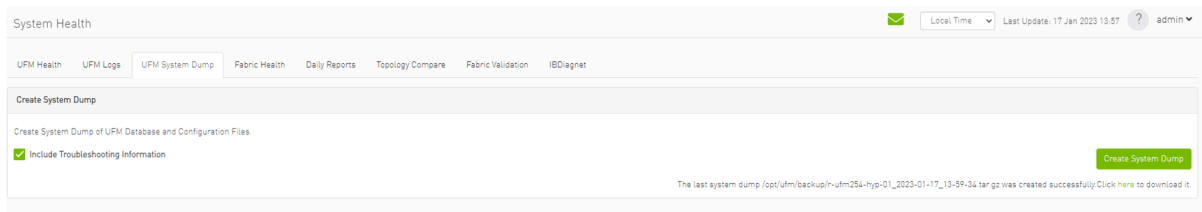

UFM will create the system dump and save the data to the predefined location. By default, the system dump files are stored under `/opt/ufm/backup` directory. You can change the location of the system dump files in the `gv.cfg` configuration file in the backup folder location section.

For example:

```
#backup folder location
backup_folder=/opt/ufm/backup
```

In addition, if you did not switch from the tab, once the system dump creation process is complete, a download link will be available for downloading the system dump file directly to the user's machine, as shown in the below example:



The `ufm_sysdump` script can be employed to extract UFM system information. The script is located in diverse locations depending on the UFM installation method.

The `ufm_sysdump` can be run without any arguments. The default location of the script output depends on the installation method. To change the default location of the script output, add the `-o` argument and specify the desired script location (e.g. `ufm_sysdump -o < output location >`).

Additionally, the UFM script gathers the Cyber-AI and HA modules system dump output and stores it in the same tar file.

Location of the `ufm_sysdump` script is as follow:

- On baremetal/HA master or standby Modes: `/usr/bin/ufm_sysdump.sh`
- Standalone Mode: it is located in `/opt/ufm/files/scripts/ufm_sysdump.sh`

The default script output location:

- Baremetal Mode: backup folder `/opt/ufm/backup`
- Standalone Mode: backup folder inside the docker. Additionally, the working directory has been established for easier copying of the results
- HA master and standby Modes: `/tmp` folder

9.6.4 Fabric Health Tab

Through Fabric Health tab, you can access the fabric health reports. There are two kinds of reports:

- Custom Reports - The user can generate a report that runs a series of checks on the fabric on demand.
- Periodic Reports - An automatically generated report that is periodically generated by the UFM.

Each check that is run for a report triggers a corresponding event. Events are also triggered when a report starts and ends. For more information, see [Events & Alarms](#).

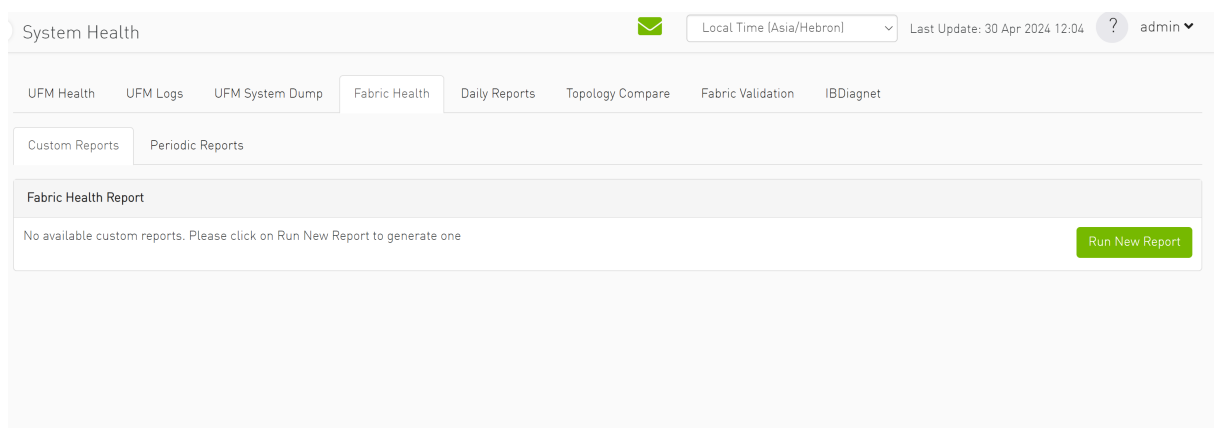

The screenshot displays the 'System Health' dashboard. At the top, there is a navigation bar with a green checkmark icon, a dropdown menu for 'Local Time (Asia/Hebron)', and a 'Last Update: 30 Apr 2024 12:04' timestamp next to a user profile icon labeled 'admin'. Below this, a horizontal menu contains several tabs: 'UFM Health', 'UFM Logs', 'UFM System Dump', 'Fabric Health' (which is currently selected), 'Daily Reports', 'Topology Compare', 'Fabric Validation', and 'IBDiagnet'. Under the 'Fabric Health' tab, there are two sub-tabs: 'Custom Reports' and 'Periodic Reports'. The main content area shows a 'Fabric Health Report' section with the message 'No available custom reports. Please click on Run New Report to generate one' and a prominent green 'Run New Report' button.

9.6.4.1 Custom Reports

 To run a new report, do the following:

1. Click “Run New Report.”

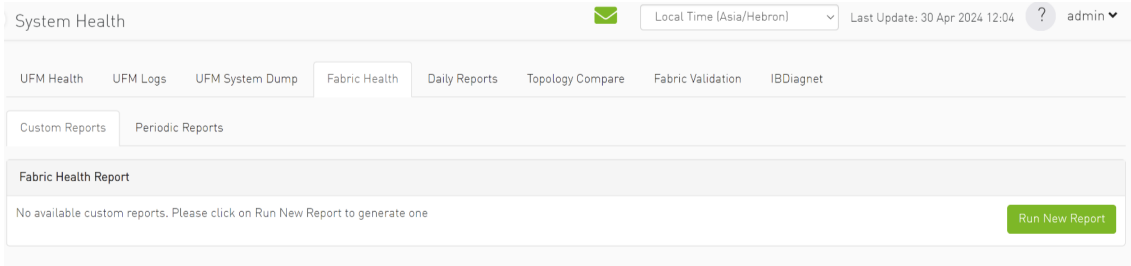

2. Select the desired fabric health checks to run in the Fabric Health Report window and click “Run Report.”

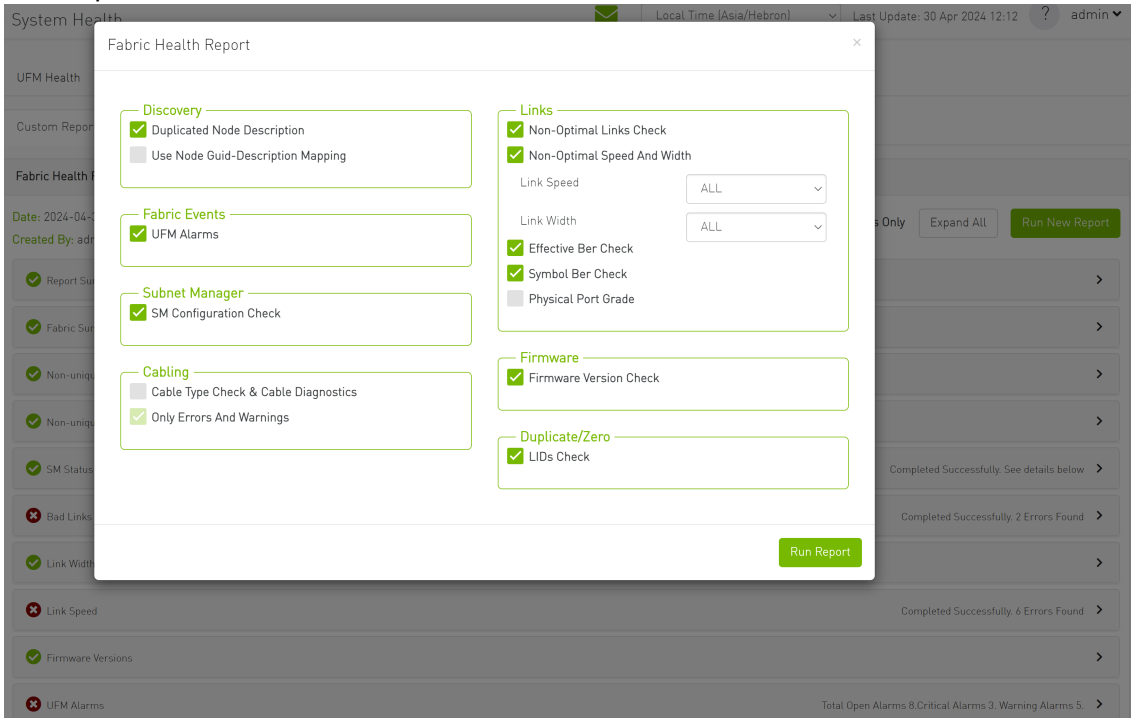

Results will be displayed automatically:

UFM Health UFM Logs UFM System Dump **Fabric Health** Daily Reports Topology Compare Fabric Validation IBDiagnet

Custom Reports Periodic Reports

Fabric Health Report

Date: 2024-04-30 12:00:27 Show Problems Only

Created By: admin

- ✓ Report Summary >
- ✓ Fabric Summary >
- ✓ Non-unique and Zero LID Values >
- ✓ Non-unique Node Descriptions >
- ✓ SM Status Completed Successfully. See details below >
- ✗ Bad Links Completed Successfully. 2 Errors Found >
- ✓ Link Width >
- ✗ Link Speed Completed Successfully. 6 Errors Found >
- ✓ Firmware Versions >

The report displays the following:

- A report summary table of the errors and warnings generated by the report.
- A fabric summary of the devices and ports in the fabric.
- Details of the results of each check run by the report.

You can expand the view of each check or expand the view of all checks at once by clicking “Expand All.”

To view only the errors of the report results, click the “Show Problems Only” checkbox.

The following table describes the checks included in the report.

Fabric Health Report Checks

Check	Description	To run, select:
Duplicate/Zero LID Check	Lists all ports with same LID or zero LID value.	LIDs Check Default: Selected
Duplicated Node Description	Lists all nodes with same node description. Does not include switches with the same description.	Duplicated Node Description Default: Selected
Use Node GUID-Description Mapping	Enables the usage of a mapping file (between node GUID and node description) when running duplicate node description analysis of the fabric. This file is located on the UFM server side at: <code>/opt/ufm/conf/sm_guid_desc_mapping.cfg</code> , and uses the following format (node_guid → description): <code>0x248a070300702710 "Desc1"</code> <code>0x248a0703007026f0 "Desc2"</code> <code>0x0002c90300494100 "Desc3"</code>	Use Node GUID-Description Mapping Default: Unchecked Note: In order for this checkbox to be available, the Duplicated Node Description checkbox should also be selected. Otherwise, this checkbox will be greyed-out.

Check	Description	To run, select:
SM Check	Checks that: <ul style="list-style-type: none"> • There is one and only one active (master) Subnet Manager in the fabric. • The master is selected according to highest priority and lowest port GUID. The report lists all SMs in the fabric with their attributes.	SM Configuration Check Default: Selected
Bad Links Check	Performs a full-fabric discovery and reports “non-responsive” ports with their path.	Non-Optimal Links Check Default: Selected
Link Width	Checks if link width is optimally used. <ul style="list-style-type: none"> • When a width is selected, the report lists the active links that do not meet the optimum for the selection. • When no width is selected (All), the test checks whether the enabled width on both sides of the link equals the configured maximum (confirms that auto-negotiation was successful). 	None-Optimal Speed and Width Default: Selected Link Width: The default is ALL.
Link Speed	Checks if link speed is optimally used. <ul style="list-style-type: none"> • When a speed is selected, the report lists the active links that do not meet the optimum for the selection. • When no speed is selected (All), the test checks whether the enabled speed on both sides of the link equals the configured maximum (confirms that auto-negotiation was successful). 	None-Optimal Speed and Width Default: Selected Link Speed: The default is ALL.
Effective Ber Check	Provides a BER test for each port, calculates BER for each port and check no BER value has exceeded the BER thresholds. In the results, this section will display all ports that has exceeded the BER thresholds. Note that there are two levels of threshold: Warning threshold (default=1e-13) and Error threshold (default=1e-8).	Effective Ber Check Default: Selected
Effective Port Grade	Provides a grade per port lane in the fabric, which indicates the current port lane quality.	Physical Port Grade Default: Not Selected
Firmware Check	Checks for firmware inconsistencies. For each device model in the fabric, the test finds the latest installed version of the firmware and reports devices with older versions.	Firmware Version Check Default: Selected
Eye Open Check	(For QDR only) Lists Eye-Opener information for each link. When minimum and maximum port bounds are specified, the report lists the links with eye size outside of the specified bounds.	Eye Open Check Default: Selected Minimum and Maximum port bound: By default no bounds are defined.

Check	Description	To run, select:
Cable Information	Reports cable information as stored in EEPROM on each port: cable vendor, type, length and serial number.	Cable Type Check & Cable Diagnostics Default: NOT selected because this test might take a long time to complete (40 msec per port)
UFM Alarms	Lists all open alarms in UFM.	UFM Alarms Default: Selected

9.6.4.2 Periodic Reports

The periodic reports are generated automatically upon UFM bring up.

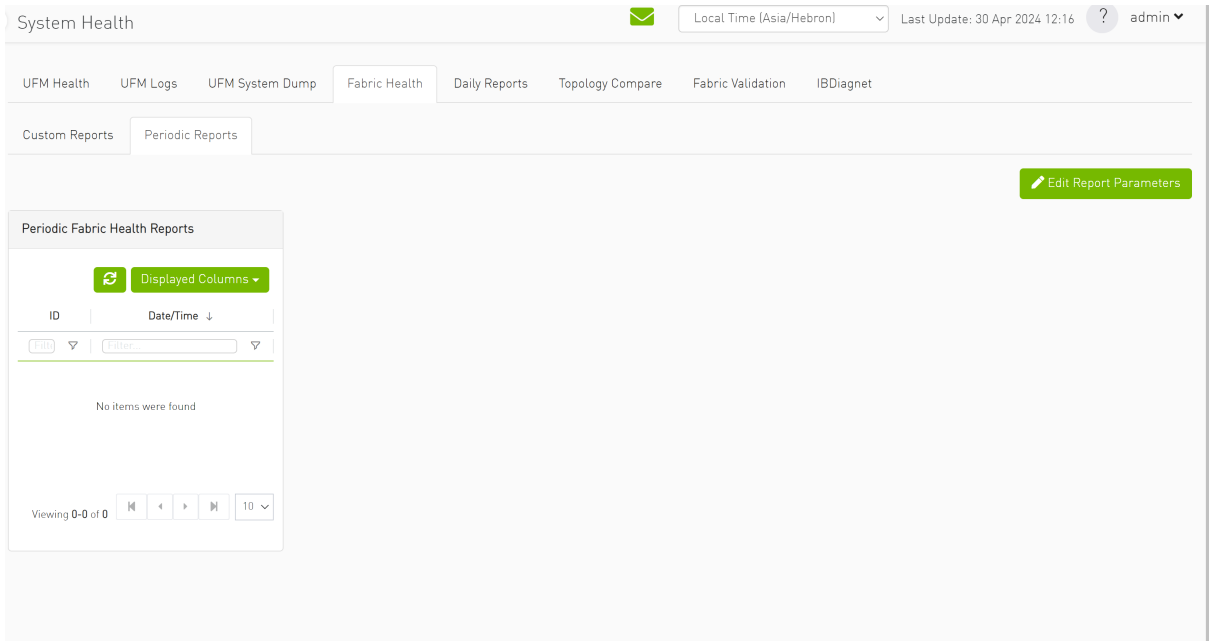

To edit the report parameters, click the "Edit Report Parameters".

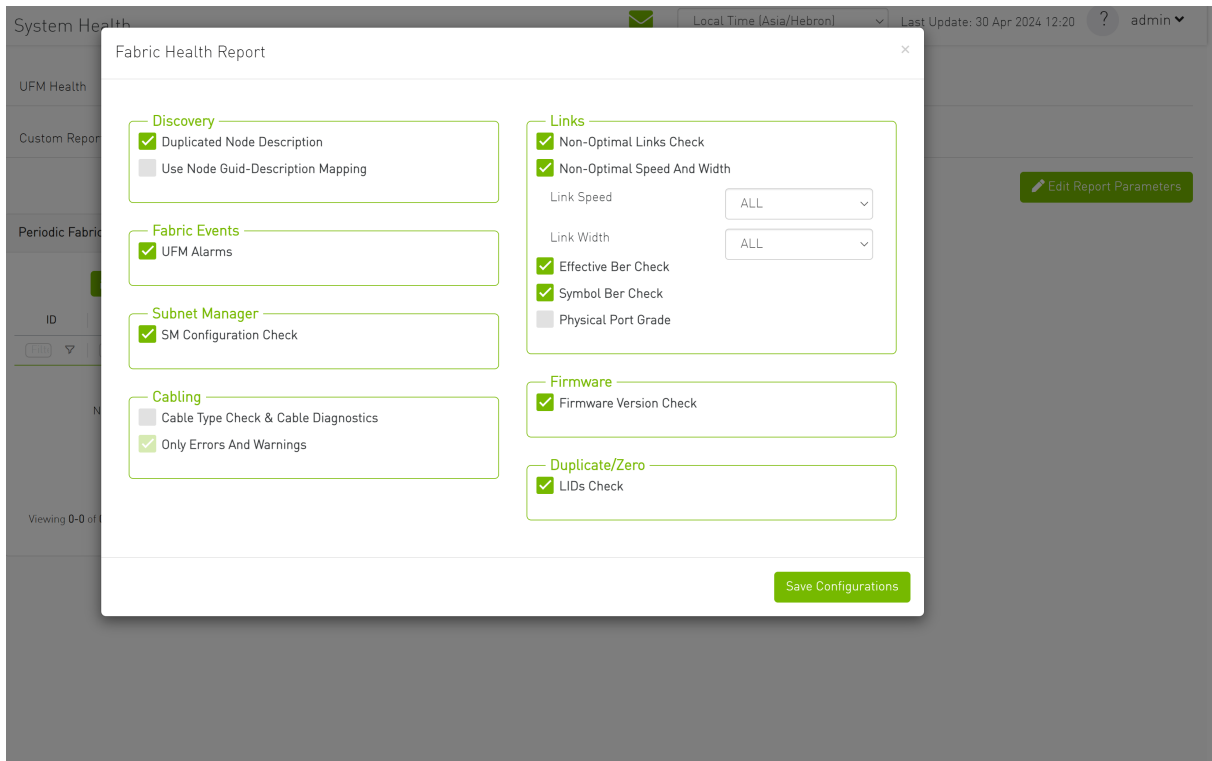

9.6.5 Daily Reports Tab

The Daily Report feature collects, analyzes, and reports the most significant issues of the fabric in the last 24 hours (from 00:00 to 24:00). The reports present statistical information such as Summary of Traffic, Congestions and UFM events that occurred during the last 24 hours. These statistics are sent to a pre-defined recipients list on a daily basis. It is also possible to specify a non-24-hour range, by updating the UFM configuration file—see section [Other Daily Report Configurations](#) for details.

The following are the formats of the Daily Report:

- Interactive—opened via the browser. The charts are displayed in SVG format. This format can be accessed from the UFM Web UI and is also sent by email as an attachment (see [Daily Report View in the Web UI](#) section below).
- Static—opened via mail client (Outlook, Gmail, Hotmail, etc). The charts are displayed in PNG format.

9.6.5.1 Activating and Deactivating the Daily Report

Daily Report can be activated/deactivated via the `/opt/ufm/conf/gv.cfg` file.

Daily Reports mechanism is activated by default.

➤ *To deactivate the Daily Report, do the following:*

1. Open the `/opt/ufm/conf/gv.cfg` file.

2. Find the DailyReport section.
3. Set the `daily_report_enabled` option to false.

```
daily_report_enabled = false
```

➤ *To re-activate the Daily Report:, do the following:*

1. Open the `/opt/ufm/conf/gv.cfg` file.
2. Find the DailyReport section.
3. Set the `daily_report_enabled` option to true.

```
daily_report_enabled = true
```

9.6.5.2 Saving Daily Reports

UFM saves the interactive Daily Reports under the `/opt/ufm/files/reports/Daily` directory. Each report will be saved under a directory with its respective date. For example, report for Sept. 28th, 2014 will be located under: `/opt/ufm/files/reports/Daily/2014-09-28/` By default, the maximum number of reports that will be saved is 365 (one per day).

➤ *To configure the maximum number of reports to save, do the following:*

1. Open the `/opt/ufm/conf/gv.cfg` file.
2. Find the DailyReport section.
3. Set the `max_reports` option to the desired value. A count of 0 (zero) means no copies are retained. (default and max is 365).
4. Restart UFM.

9.6.5.3 Other Daily Report Configurations

All the Daily Report configuration parameters can be found in the "DailyReport" section in `gv.cfg` configuration file.

The following are additional Daily Report configurations options:

- `top_x` option specifies the number of results in the "Top X" charts. Max number can be 20. (Default value is 10). `top_x` value will be applied to all charts existing in the Daily Report.
- `mail_send_interval` option specifies the epoch in minutes after midnight that the report can be emailed. By default, if UFM was down during midnight, and was restarted after 1:00, the

report of the previous day will be generated and saved, but will not be emailed. This can be changed by editing the `mail_send_interval`. (default value is 60 minutes, meaning that the report will be send only between 00:00 to 1:00).

- `log_level` option specifies the Daily Report log verbosity. Default value is INFO (optional values: INFO, WARNING and ERROR).
- `attach_fabric_health_report` option indicates whether or not to add the fabric health report as attachment to the mail. Default value is true (optional values: true or false).
- `fabric_health_report_timeout` specifies the max time in seconds, to wait for fabric health report generation. Default value is 900 seconds (15 minutes).
In case of large fabrics, fabric health report might take longer than the default 15 minutes. User can enlarge the timeout for fabric health report to complete.
- `max_attached_file_size` specifies the maximum file size in Bytes for each email attachment that can be sent. Default value is 2 Megabytes.
If the size of a certain file has exceeded this value, the file will not be sent as an attachment in the Daily Report mail.

```
[DailyReport]
# top_x specifies the number of results per each top x chart.
# max number can be 20.(default is 10)
top_x=10
# max_reports specifies the number of reports to save.
# A count of 0 (zero) means no copies are retained.(default and max is 365)
max_reports = 365
#time interval in minutes after midnight
#when passed mail will not be sent
mail_send_interval=60
log_level = INFO
daily_report_enabled = true
attach_fabric_health_report = true
fabric_health_report_timeout = 900
# max attached file size in bytes, default is 2M (2097152 Bytes)
max_attached_file_size = 2097152
```

- `max_attached_file_size` specifies the maximum file size in Bytes for each email attachment that can be sent. Default value is 2 Megabytes.
- The `start_hour` and `end_hour` options enable selecting a sub-range of the day, during which, the relevant report data will be collected. Since by default this option is configured to collect data from the last 24 hours, the default `start_hour` is set to 0 (or 00), and the default `end_hour` is set to 24.

If these options are configured to different values, the generated report will include data from the specified interval only. The `start_hour` values range is 00 to 23, and the `end_hour` values range is 00 to 24. The specified `end_hour` must be greater than the specified `start_hour`. If, for example, the `start_hour` is configured to 08, and the `end_hour` is configured to 10, the generated report will include data collected between 08:00-10:00 (excluding 10:00).

9.6.5.4 Report Content

9.6.5.4.1 Sidebar







The Sidebar includes general information regarding the fabric, such as: the site name, number of switches and hosts in the fabric, and the dates on which the report was generated.

Navigation between the charts can be done via the menu charts on the sidebar.

Fabric
Events (by severity)
Normalized Traffic and Congestion
Hosts Utilization
Most active events
Hosts
Top Senders (Hosts only)
Hosts with most events
Hosts with most critical events
Most congested hosts
Hosts with most link down events
Switches
Switches with most events
Switches with most critical events
Most congested switches
Switches with most link down events

9.6.5.4.2 Daily Report Highlights

The top of the report shows highlight activities of the network, such as: the host with the most events, the most congested host and switch, and top sender host. To see the related chart of each highlight, click the corresponding  icon in the "Link to chart column."

Highlights		
	Highlight	Link to chart
Switch with most events	'switch-630744'	
Host with most events	'r-ufm135 HCA-1'	
Total events during the last 24 hours	total: 110973, critical events: 14877, warning events: 14784, minor events: 81312.	
Most congested host	'r-ufm87 HCA-1' (20.0% congestion)	
Top sender host	'r-ufm86 HCA-1' (46.0% BW and 0% congestion)	
Highest traffic patterns	Highest traffic hour: 09:00-10:00 (46.0% BW), Most congested hour: 23:00-24:00 (10.0% congestion)	
Number of unhealthy ports	0	N/A

9.6.5.4.3 Available Charts

9.6.5.4.3.1 Events by Severity

Events by Severity displays in a graphical view the distribution of all the UFM events that occurred during each hour. Events are separated into the following severity levels: Critical, Minor, and Warning.

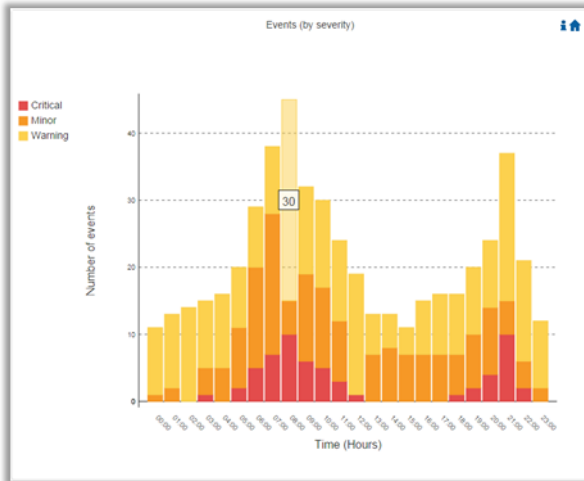

Hovering over the bars in the interactive report displays the amount of events per hour.

9.6.5.4.3.2 Normalized Traffic and Congestion

Normalized Traffic and Congestion displays in a graphical view the normalized traffic and congestions of the fabric. This graph displays the accumulated data for the Senders in the fabric (not including switches).

Congestion normalization is based on the number of delayed packets (packets that wait in the queue) and bandwidth loss.

The graph displays the percentage of the traffic utilization in green and the percentage of the congestion in red.

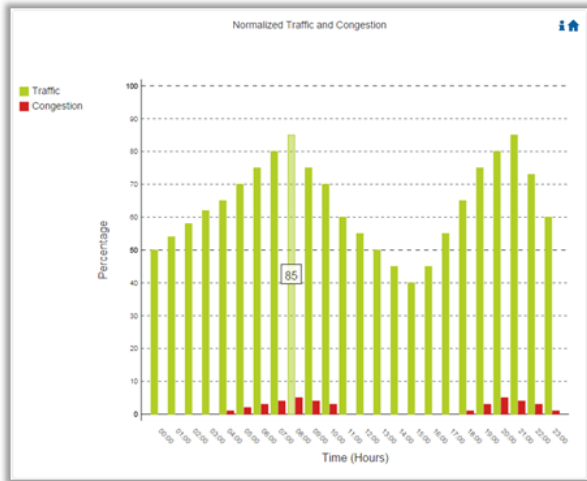

Hovering over the bars in the interactive report displays the percentage of the traffic/ congestion per hour.

9.6.5.4.3.3 Hosts Utilization Distribution

Hosts Utilization Distribution displays in a graphical view the groups of hosts, where each host belongs to a specific group according to its utilization status.

To see the hosts in each group, click on the pie chart (at the interactive report).

The utilization groups are:

- Very low—up to 20% utilized
- Low—20-40% utilized
- Moderate—40-60% utilized
- High—60-80% utilized
- Very high—80-100% utilized

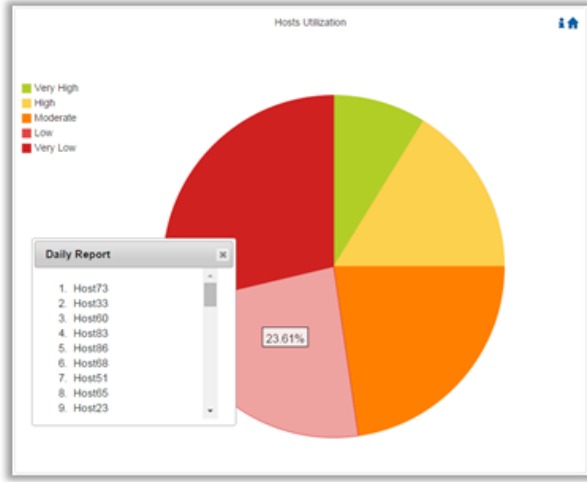

Hovering over the slices in the interactive report displays the percentage of hosts in this group.

9.6.5.4.3.4 Most Active Events

Most Active Events displays in a graphical view the most active events, ordered by the number of occurrences during the last 24 hours.

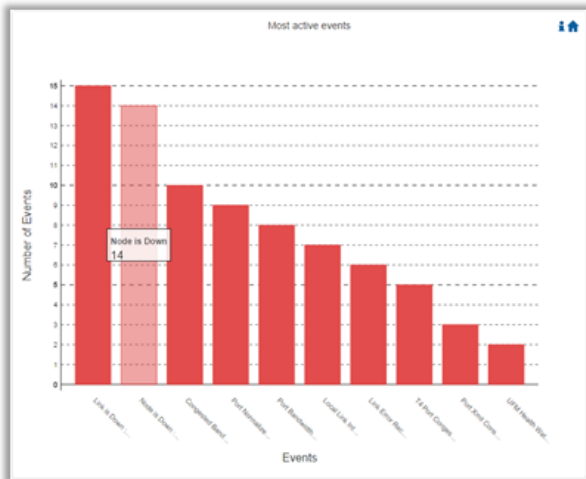

Hovering over the bars in the interactive report displays the number of occurrences for each active event, and hovering on each event's name displays a tooltip with the event's description.

9.6.5.4.3.5 Top Senders

Top Senders displays in a graphical view the normalized traffic and congestions of the top sender hosts. Congestion normalization is based on the number of the delayed packets (packets that wait in queue) and bandwidth loss.

The graph displays the percentage of the traffic utilization in green and the percentage of the congestion in red.

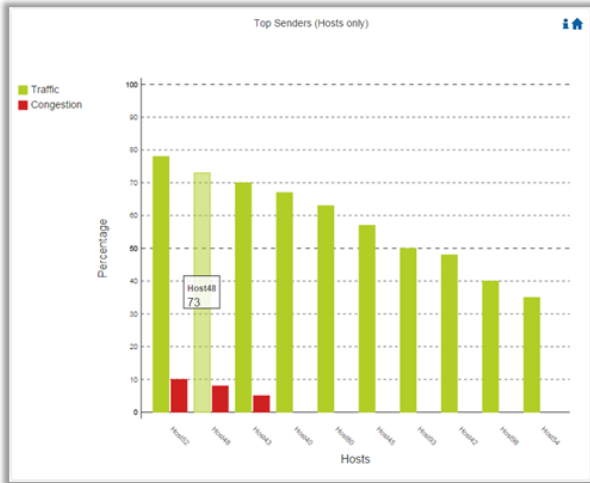

Hovering over the bars in the interactive report displays the percentage of the traffic/ congestion for a selected host.

9.6.5.4.3.6 Hosts with Most Events

Hosts with Most Events displays in a graphical view the hosts with the most events. Events are separated into the following severity levels: Critical, Minor, and Warning.

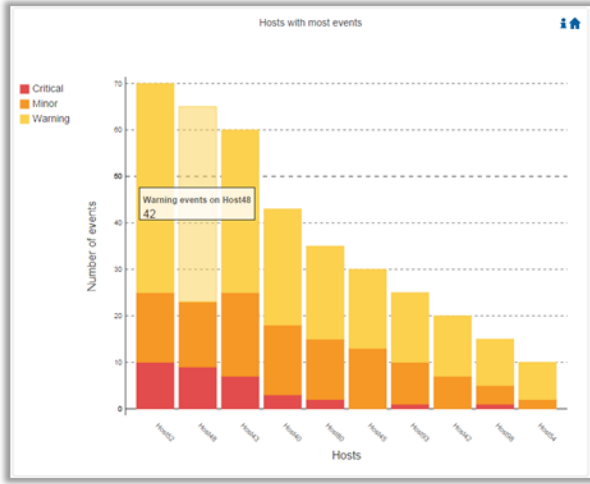

Hovering over the bars in the interactive report displays the amount of events per severity for a selected host.

9.6.5.4.3.7 Hosts with Most Critical Events

Hosts with Most Critical Events displays in a graphical view the hosts with the most critical events.

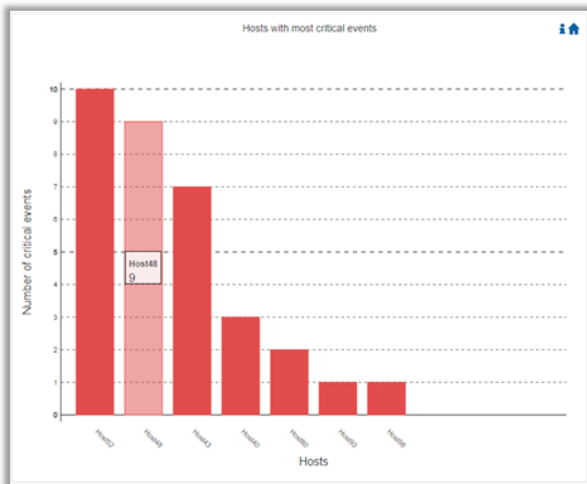

Hovering over the bars in the interactive report displays the amount of critical events for a selected host.

9.6.5.4.3.8 Most Congested Hosts

Most Congested Hosts displays in a graphical view the normalized congestions of the most congested hosts. Congestion normalization is based on the number of the delayed packets (packets that wait in queue) and bandwidth loss.

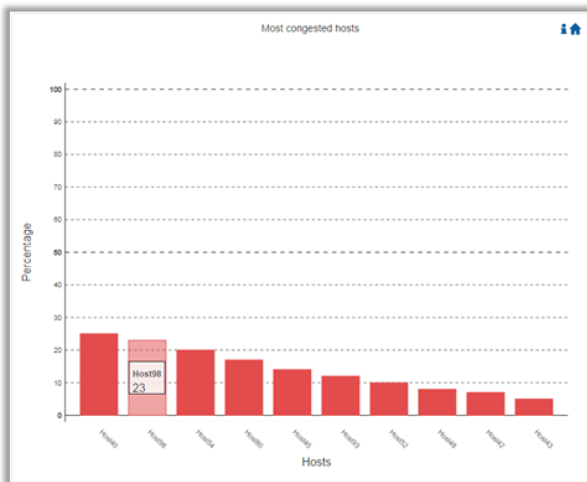

Hovering over the bars in the interactive report displays the percentage of the congestion for a selected host.

9.6.5.4.3.9 Hosts with Most Link Down Events

Hosts with Most Link Down Events displays in a graphical view the list of the hosts with the most link down events during the last 24 hours.

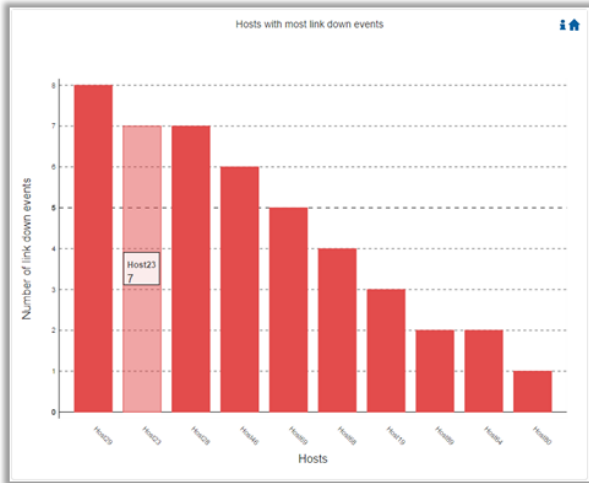

Hovering over the bars in the interactive report displays the amount of link-down events for a selected host.

9.6.5.4.3.10 Switches with Most Events

Switches with Most Events displays in a graphical view the switches with the most events. Events are separated into the following severity levels: Critical, Minor, and Warning.

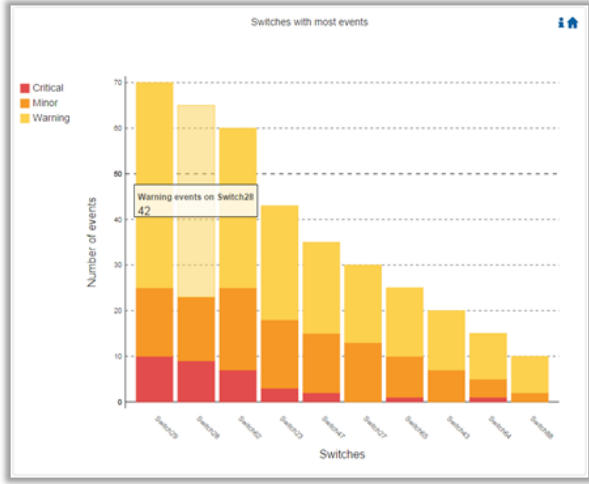

Hovering over the bars in the interactive report displays the amount of events per severity for a selected switch.

9.6.5.4.3.11 Switches with Most Critical Events

Switches with Most Critical Events displays in a graphical view the switches with the most critical events.

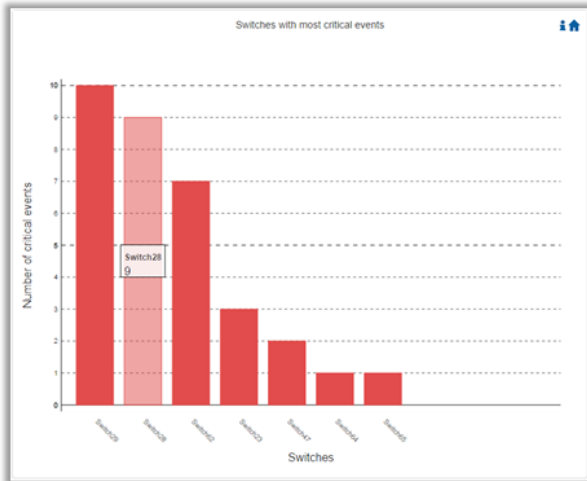

Hovering over the bars in the interactive report displays the amount of critical events for a selected switch.

9.6.5.4.3.12 Most Congested Switches

Most Congested Switches displays in a graphical view the normalized congestions of the most congested switches. Congestion normalization is based on the number of delayed packets (packets that wait in queue) and bandwidth loss.

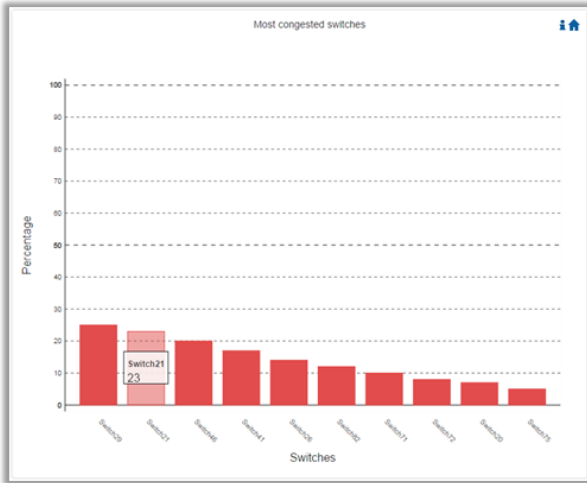

Hovering over the bars in the interactive report displays the percentage of the congestion for a selected switch.

9.6.5.4.3.13 Switches with Most Link Down Events

Switches with Most Link Down Events displays in a graphical view the list of the switches with the most link down events during the last 24 hours.

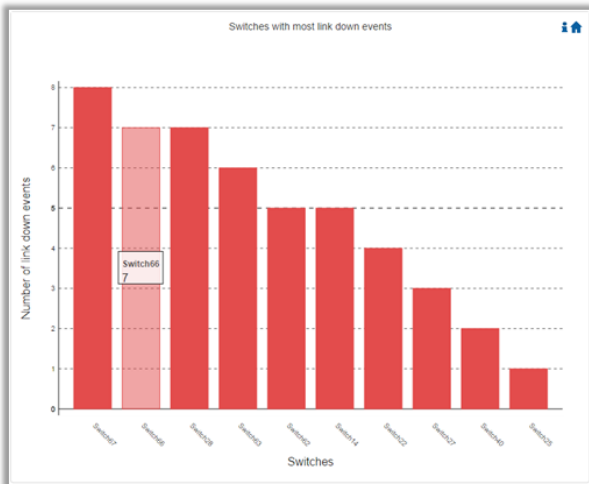

Hovering over the bars in the interactive report displays the amount of link-down events for a selected switch.

Clicking on the “help” icon  in the upper right corner of each chart, in the interactive report, will display a short description of the chart.

Clicking on the “home” icon  in the upper right corner of each chart, in the interactive report, will move the display to the beginning of the report.

On charts: “Events by Severity”, “Hosts with Most Events”, and “Switches with Most Events”, if the maximum value in the Y-axis is less than 5, an “m” unit will appear and stand for “milli”.

For all charts, if the value is higher than 1000 in the Y-axis, a “k” unit will appear and stand for “killo”.

9.6.5.4.4 Daily Report View in the Web UI

In this tab, you can select the UFM daily reports that you wish to view and you can specify the recipients to which these daily reports will be sent.

 To view a specific daily report, click the relevant report date from the list of available daily reports.

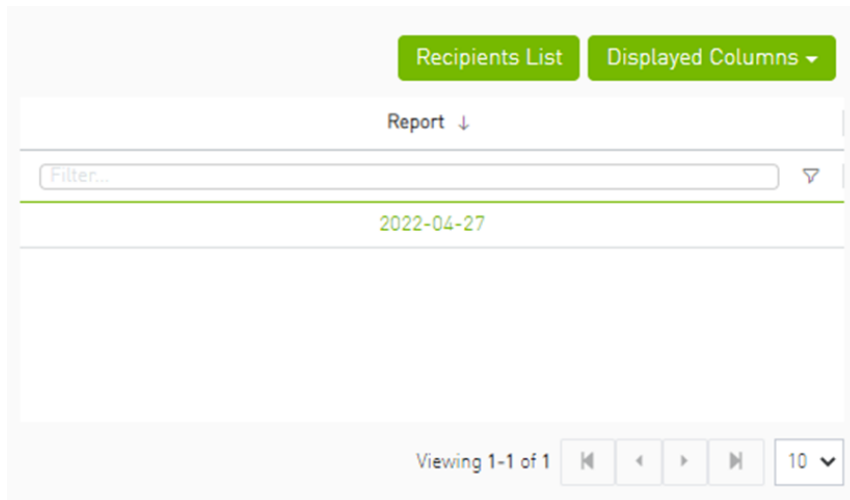

The specified report content will be displayed when clicking the report (see [Activating and Deactivating the Daily Report](#)).

➤ To configure the Recipients list for the daily reports, do the following:

1. Click Recipients List under System Health → Daily Reports tab.

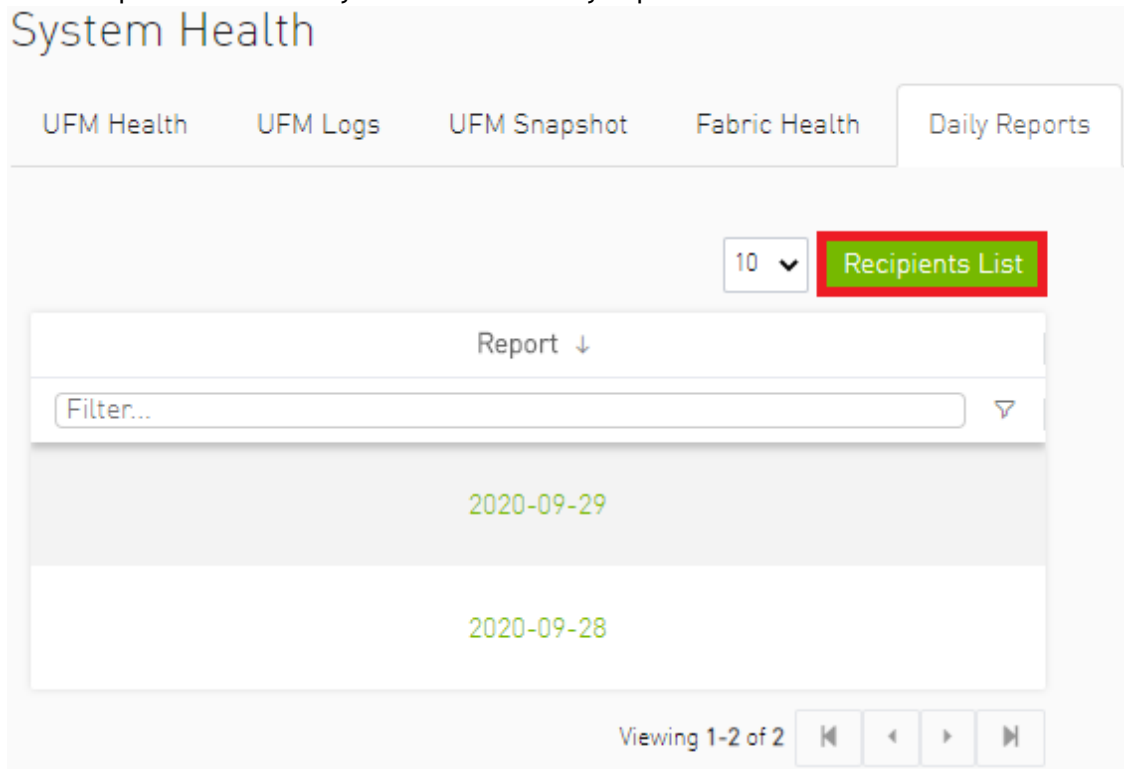

2. Click New.

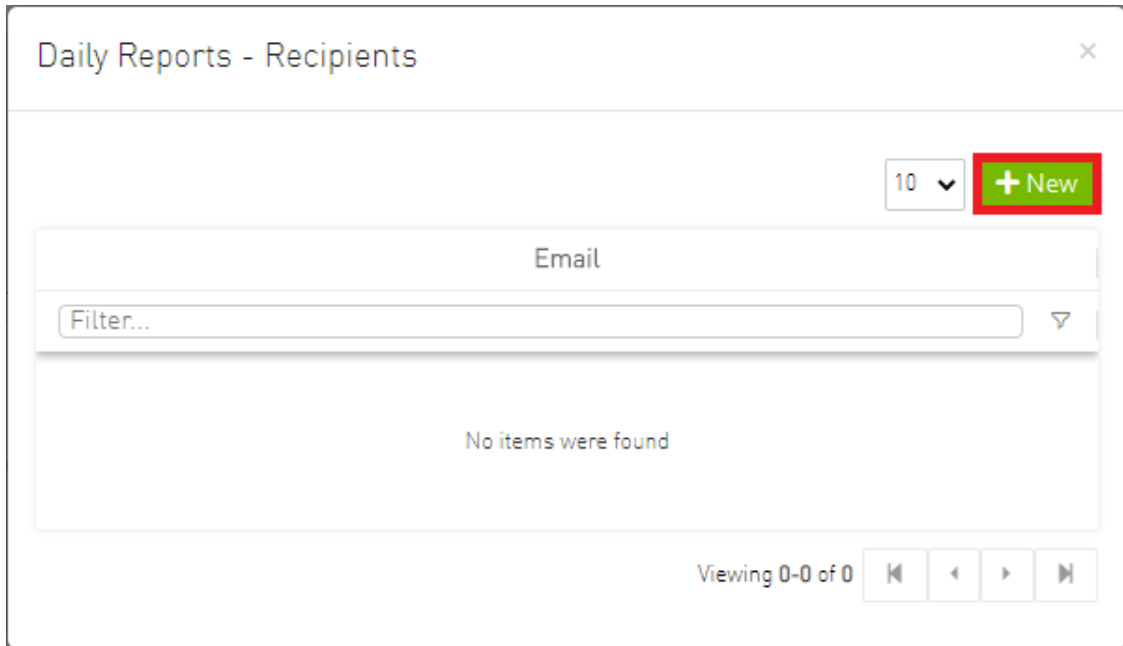

3. In the Recipients List window, enter valid recipient email addresses, comma-separated, and click Submit.

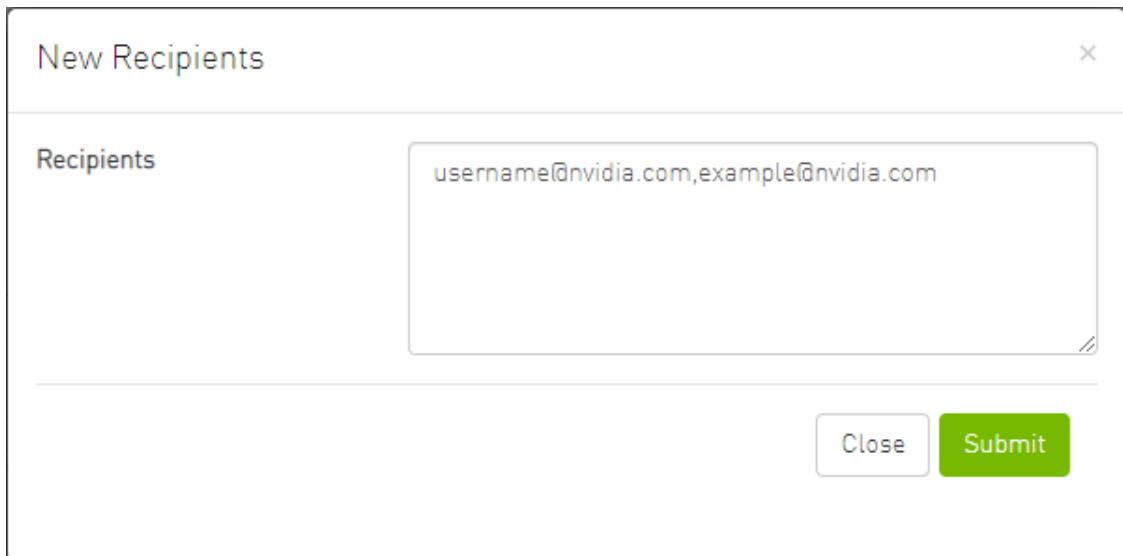

The new recipient/recipients will be added to the Daily Reports Recipients list.

Email
user@user.com

Viewing 1-1 of 1

These recipients will automatically start receiving the UFM daily reports.

9.6.6 Topology Compare Tab

9.6.6.1 Overview

The Topology Compare tab allows two methods of topology comparison:

- Periodic Comparison - allows users to compare the current fabric topology with a preset master topology.
- Custom Comparison - compares user-defined topology with the current fabric topology.

9.6.6.1.1 Periodic Comparison

Periodic comparison allows users to compare the current fabric topology with a preset master topology. The master topology may be set either by selecting the current topology or uploading a predefined custom topology.

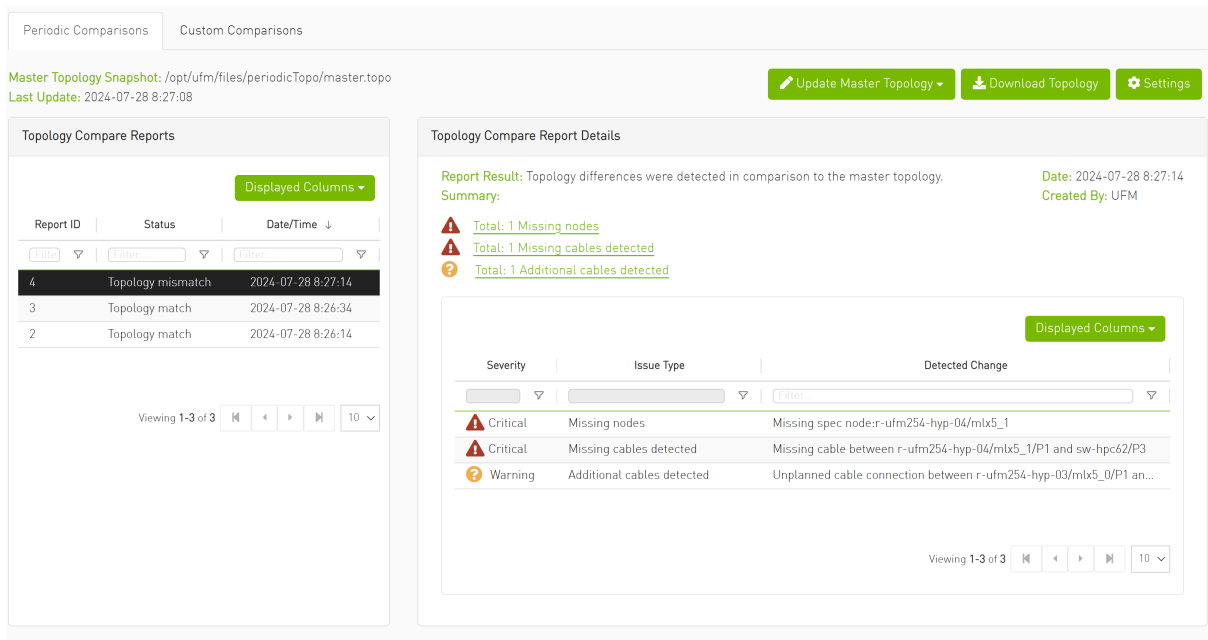

When a report is selected from the "Topology Compare Reports" table, its result are displayed on the right side under "Topology Compare Report Details".

Once a topology comparison is initiated by the UFM, the latest (current) topology is compared with the master topology. Upon UFM's bring-up and by default, the UFM sets the latest topology as master.

- To update the master topology with the latest (current) topology or a custom topology saved in an external file, click the "Updated Master Topology" dropdown button.

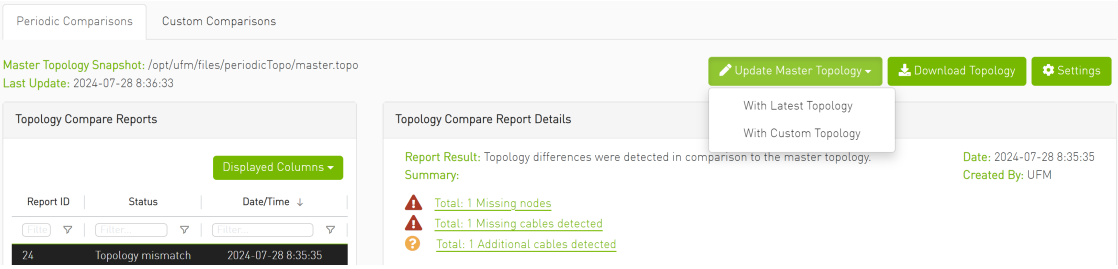

- To download the current topology as a `.topo` file, click the "Download Topology" button.
- The Settings button navigates to the [Topology Compare tab](#) of the Settings view which allows users to configure periodic comparison settings.

9.6.6.1.2 Custom Comparison

Custom comparison compares user-defined topology with the current fabric topology. UFM compares the current fabric topology to a topology snapshot (of the same setup) and reports any differences between them.

To be able to use the UFM topology comparison mechanism, first you need to create a TOPO file that defines the current topology of the fabric.

Ideally, the topology snapshot (`.topo` file) should be taken after the setup bring-up phase has been completed so that no more topology changes are expected to take place.

Once the TOPO file is created, you can use the topology comparison mechanism to compare the current fabric topology to the one in the TOPO file and view their differences (if found).

Periodic Comparisons Custom Comparisons Compare Latest Topology

Custom Topology Compare Report

Report Result: Topology differences were detected in comparison to the master topology. Date: 2024-07-28 8:35:35
Created By: UFM

Summary:

- Total: 1 Missing nodes
- Total: 1 Missing cables detected
- Total: 1 Additional cables detected

Severity	Issue Type	Detected Change
Critical	Missing nodes	Missing spec node:r-ufm254-hyp-04/mix5_1
Critical	Missing cables detected	Missing cable between r-ufm254-hyp-04/mix5_1/P1 and sw-hpc62/P3
Warning	Additional cables detected	Unplanned cable connection between r-ufm254-hyp-03/mix5_0/P1 and sw-hpc62/P3

Viewing 1-3 of 3

To compare the current topology with the master topology or a custom topology (external file), make a selection from the "Compare Latest Topology" dropdown button and upload the `.topo` file to compare against.

9.6.6.2 Topology Comparison Flow

To create the topology file for later comparison with the current topology, do the following:

1. Verify that the following path for ibdiagnet ibnl directory exists: `/opt/ufm/tmp/ibdiagnet.out/tmp/ibdiag_ibnl`. If the path does not exist, make sure to create it manually.
2. Run the following command on the UFM server machine to create the topology file (`mytopo.topo`). Note that the file extension must be `.topo` for UFM to recognize it.

```
/opt/ufm/opensm/bin/ibdiagnet -w /tmp/mytopo.topo
--out_ibnl_dir /opt/ufm/tmp/ibdiagnet.out/tmp/ibdiag_ibnl
```

Once command execution is completed, the new topology file (`/tmp/mytopo.topo`) will be created and can be used for later comparison with the current fabric topology. Also, several `.ibnl` files that were (optionally) created will be found in the defined output directory (`/opt/ufm/tmp/ibdiagnet.out/tmp/ibdiag_ibnl`). These `.ibnl` files will be used when comparing any topology file to the current fabric topology.

At any time during your UFM session, you can view the last generated report through the UFM web UI or in HTML format in a browser window.

➤ To perform topology comparison, do the following:

1. Click Run Now Report under System Health à Topology Compare.



2. Browse for the required topology setup file in the *Load Topology File* dialog box.



3. Click Load.
UFM will compare topologies and display the results.

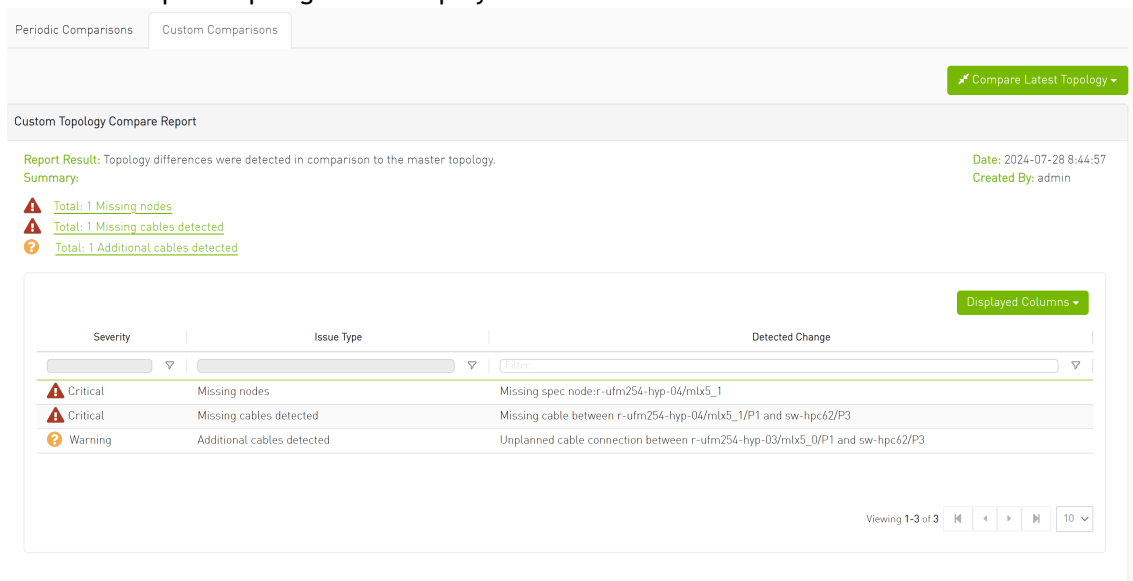

9.6.7 Fabric Validation Tab

The Fabric Validation tab displays the fabric validation tests and gives the ability to run the test and receive/view the summary as a job output. Summary of the job contains all errors and warnings that were found during the test execution.

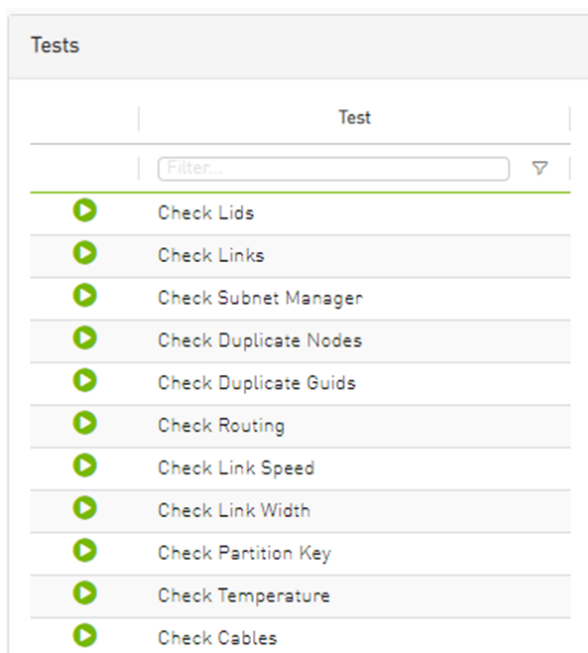

Test	Description
Check Lids	Checks for bad lids. Possible lid errors are: <ul style="list-style-type: none"> • zero lid • lid duplication
Check Links	Checks for connectivity issues where all ports connected are not in the same state (active)
Check Subnet Manager	Checks for errors related to subnet manager. Possible SM errors are: <ul style="list-style-type: none"> • Failed to get SMInfo Mad • SM Not Found • SM Not Correct (master SM with wrong priority) • Many master SMs exists
Check Duplicate Nodes	Checks for duplications in nodes description
Check Duplicate Guides	Checks for GUIDs duplications
Check Routing	Checks for failures in getting routing MADs
Check Link Speed	Checks for errors related to link speed. Possible link speed errors are: <ul style="list-style-type: none"> • Different speed between ports • Wrong configuration - 'enable' not part of the 'supported' • Unexpected speed
Check Link Width	Checks for errors related to link width. Possible link width errors are: <ul style="list-style-type: none"> • Different width between ports • Wrong configuration - 'enable' not part of the 'supported' • Unexpected width
Check Partition Key	Checks for errors related to PKey. Possible PKey errors are: <ul style="list-style-type: none"> • Failed to get Pkey Tables • Mismatching pkeys between ports
Check Temperature	Checks for failure in getting temperature sensing.

Test	Description
Check Cables	Checks for errors related to cables. Possible cable errors are: <ul style="list-style-type: none"> This device does not support cable info capability Failed to get cable information (provides a reason)
Check Effective BER	Checks that the Effective BER does not exceed the threshold
Dragonfly Topology Validation	Validate if the topology is Dragonfly
SHARP Fabric Validation	Checks for SHARP Configurations in the fabric
Tree Topology Validation	Checks if the fabric is a tree topology
Socket Direct Mode Reporting	Presents the inventory of fabric HCAs that are using socket direct

To run a specific test, click the play button. The job will be displayed once completed.

The screenshot shows a user interface for running tests. On the left, a 'Tests' panel lists various tests, with 'Check Lids' selected. On the right, the 'Check Lids' job details are shown, including a 'Fabric Summary' table:

Category	Count
Total Nodes	56
IB Switches	15
IB Channel Adapters	30
IB Aggregation Nodes	11
IB Routers	0

The job will also be displayed in the Jobs window.

Some validation tests contain data related to devices or ports like device GUID and port GUID.

Depending on that information a context menu for each related device/port can be shown.

If the data is related to a port the context menu will contain both port and device options.

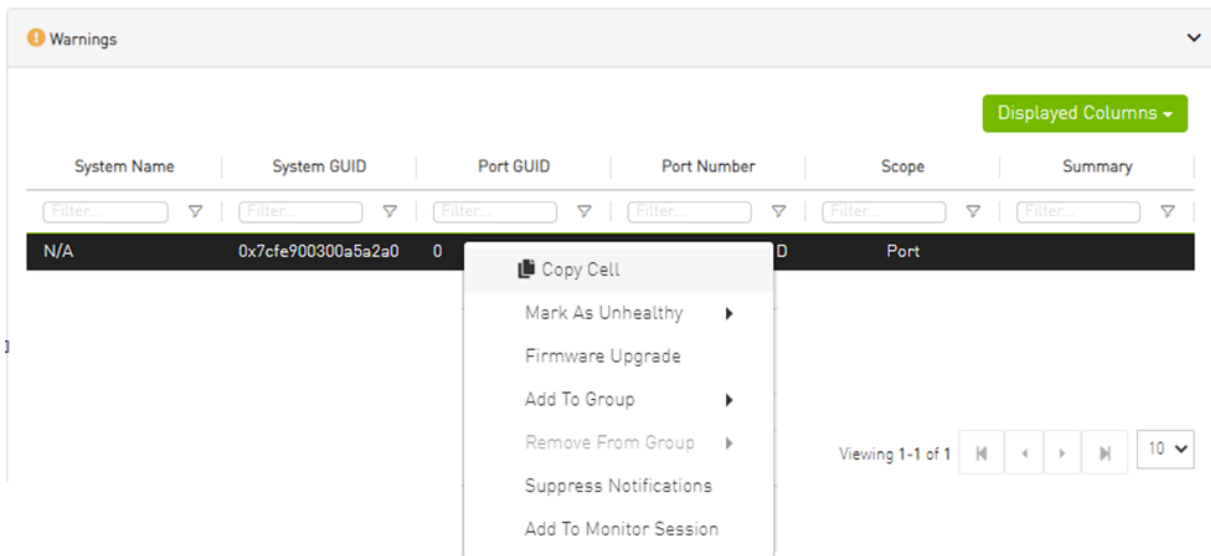
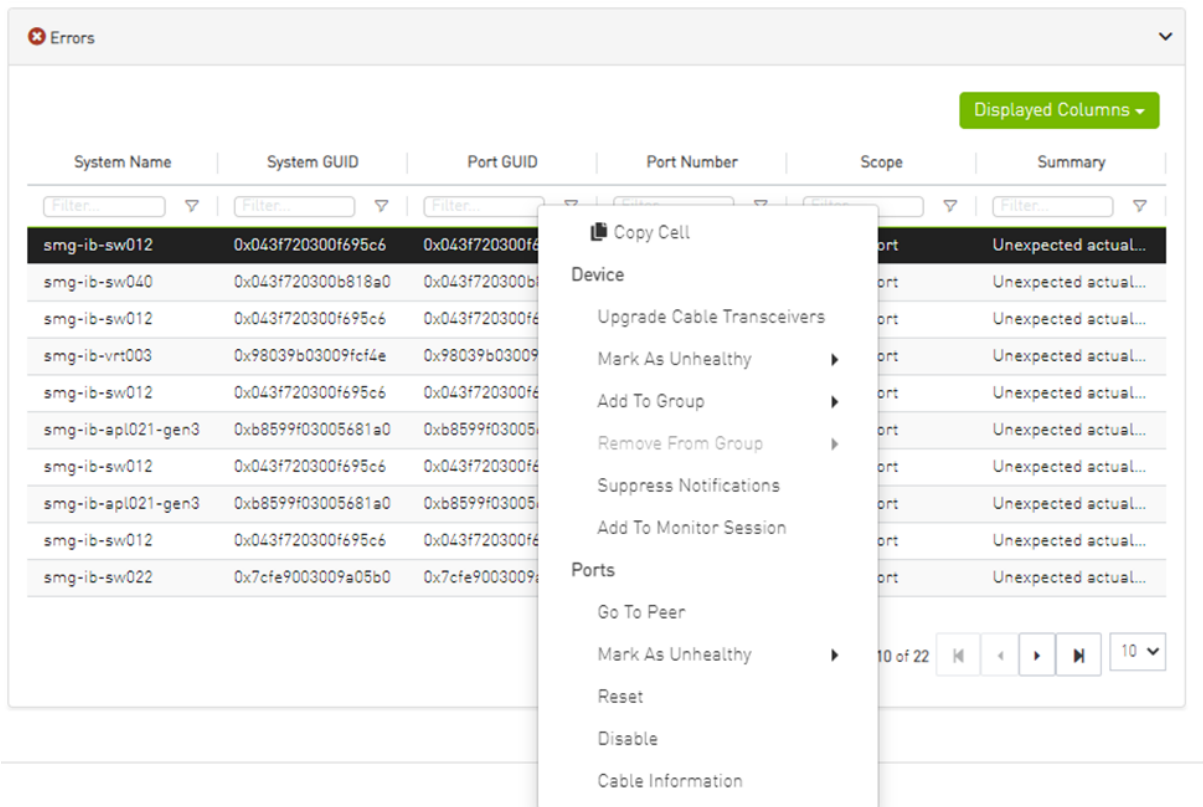

9.6.8 IBDiagnet Tab

The periodic IBDiagnet tab allows users to create scheduled ibdiagnet tasks on their devices using any of the defined parameters.

Users can also configure a remote location (local/remote) to save the ibdiagnet output to. To create a new ibdiagnet command:

1. Click the New button on the top right of the IBDiagnet tab to open the “New IBDiagnet Command” wizard.

New IBDiagnet Command

1 Parameters 2 Run

Name
IBDiagnet_CMD_1609284355963

Category	Status	Flag Name	Value
Filter...		Filter...	
General			
Link Validation			
	<input checked="" type="checkbox"/>	--ls	2.5
	<input type="checkbox"/>	--lw	1x
Port Counters			
	<input type="checkbox"/>	--pc	
	<input checked="" type="checkbox"/>	--pm_pause_time	1
	<input type="checkbox"/>	--per_slvl_cntrs	
	<input type="checkbox"/>	--sc	
	<input type="checkbox"/>	--scr	
	<input type="checkbox"/>	--extended_speeds	sw

Additional Parameters

Type additional flags for ibdiagnet run

Next

2. Select the desired ibdiagnet flags for your command by selecting the listed flags (categories are expandable), or by manually adding the desired flags into the Additional Parameters box below, and then click Next.

New IBDiagnet Command

1 Parameters 2 Run

Name
IBDiagnet_CMD_1601490607733

Category	Status	Flag Name	Value
Filter...			
General			
Link Validation			
	<input checked="" type="checkbox"/>	--ls	2.5
	<input checked="" type="checkbox"/>	--lw	1x
Port Counters			
	<input type="checkbox"/>	--pc	
	<input checked="" type="checkbox"/>	--pm_pause_time	1
	<input type="checkbox"/>	--per_slvl_cntrs	
	<input type="checkbox"/>	--sc	
	<input type="checkbox"/>	--scr	
	<input type="checkbox"/>	--extended_speeds	sw

Additional Parameters

Type additional flags for ibdiagnet run

Next

It is possible to use the filters at the top of the Category and Flag Name columns in order to search for flags.

3. In the Run screen:
 - a. Select the location of the ibdiagnet results. UFM can export ibdiagnet command run results to a local location on the UFM server, or to a [configurable remote location](#).

- b. Select whether you would like to save this run for later (Save), run it immediately (Save and Run Now), or schedule it for a later time (Schedule) and then click Finish.

New IBDiagnet Command

1 Parameters 2 Run

Location
 Local Remote

Output Path: /opt/ufm/files/periodicibdignet

Running Mode
 Save
 Save and Run Now
 Schedule

Save

Summary

Previous Finish

Note that you can see the summary of your chosen flags for this run in the Summary panel.

You will then be able to see run results on the tab which will display where the output is saved on the server.

Output Path: /opt/ufm/files/periodicibdignet

IBDiagnet

+ New Displayed Columns CSV

Name	Task State	Last Run ↓	Last Run Output
IBDiagnet_CMD_1651155713770	Disabled	28/04/2022 17:22:15	/opt/ufm/files/periodicibdignet/IBDiag...

Viewing 1-1 of 1

It is also optional to edit/activate/deactivate/delete a running task using right-click.

Under gv.cfg, it is possible to configure other parameters.

```
[PeriodicIbdiagnet]
# Directory location where outputs are written
periodic_ibdiagnet_dir_location=/opt/ufm/files/periodicIbdiagnet
# Minimum time between two tasks (in minutes)
minimum_task_interval=60
# Maximum number of tasks running simultaneously
max_optional_tasks=5
# Maximum number of outputs to save per task (oldest gets deleted)
max_saved_outputs=5
# Percentage threshold for disk usage from which UFM deletes old task results
disk_usage_threshold=80
```

UFM restart is required for these changes to take effect.

9.7 Jobs

All information provided in a tabular format in UFM web UI can be exported into a CSV file.

The Jobs window displays all of UFM running Jobs. A Job is a running task defined by the user and applied on one or more of the devices (provisioning, software upgrade, firmware upgrade, reboot, etc.).

UFM users can monitor the progress of a running job, as well as the time it was created, its last update description and its status. The status value can be “Running” (during operation) “Completed with Errors”, in case an error has occurred, and “Completed.”

ID ↓ 1	Description	Created ↓ 2	Last Update ↓ 3	Status	Summary	Progress
34	running user defined ibdiagnet...	2022-04-28 17:22:13	2022-04-28 17:22:16	Completed	View Summary	<div style="width: 100%; background-color: green;"></div>
33	Fabric validation CheckPartitio...	2022-04-28 17:16:46	2022-04-28 17:16:46	Completed	View Summary	<div style="width: 100%; background-color: green;"></div>
32	Fabric validation CheckDuplica...	2022-04-28 17:16:32	2022-04-28 17:16:33	Completed	View Summary	<div style="width: 100%; background-color: green;"></div>
31	Fabric validation CheckSubnet...	2022-04-28 17:16:26	2022-04-28 17:16:26	Completed	View Summary	<div style="width: 100%; background-color: green;"></div>
30	Fabric validation CheckLinks t...	2022-04-28 17:16:19	2022-04-28 17:16:20	Completed	View Summary	<div style="width: 100%; background-color: green;"></div>
29	Fabric validation CheckTemper...	2022-04-28 17:16:12	2022-04-28 17:16:13	Completed	View Summary	<div style="width: 100%; background-color: green;"></div>
28	Fabric validation RailOptimized...	2022-04-28 17:16:08	2022-04-28 17:16:09	Completed With Errors	View Summary	<div style="width: 100%; background-color: red;"></div>
27	Fabric validation CheckSymbol...	2022-04-28 17:16:03	2022-04-28 17:16:05	Completed	View Summary	<div style="width: 100%; background-color: green;"></div>
26	Fabric validation CheckEffectiv...	2022-04-28 17:15:57	2022-04-28 17:15:59	Completed	View Summary	<div style="width: 100%; background-color: green;"></div>
25	Fabric validation CheckCables ...	2022-04-28 17:15:51	2022-04-28 17:15:52	Completed	View Summary	<div style="width: 100%; background-color: green;"></div>

When selecting a job from the main Jobs table, its related sub jobs will be displayed in the Sub Jobs table below.

ID ↓ 1	Description	Created ↓ 2	Last Update ↓ 3	Status	Summary	Progress
34	running user defined ibdiagnet...	2022-04-28 17:22:13	2022-04-28 17:22:16	Completed	View Summary	<div style="width: 100%; height: 10px; background-color: green;"></div>
33	Fabric validation CheckPartitio...	2022-04-28 17:16:46	2022-04-28 17:16:46	Completed	View Summary	<div style="width: 100%; height: 10px; background-color: green;"></div>
32	Fabric validation CheckDuplica...	2022-04-28 17:16:32	2022-04-28 17:16:33	Completed	View Summary	<div style="width: 100%; height: 10px; background-color: green;"></div>
31	Fabric validation CheckSubnet...	2022-04-28 17:16:26	2022-04-28 17:16:26	Completed	View Summary	<div style="width: 100%; height: 10px; background-color: green;"></div>
30	Fabric validation CheckLinks t...	2022-04-28 17:16:19	2022-04-28 17:16:20	Completed	View Summary	<div style="width: 100%; height: 10px; background-color: green;"></div>
29	Fabric validation CheckTemper...	2022-04-28 17:16:12	2022-04-28 17:16:13	Completed	View Summary	<div style="width: 100%; height: 10px; background-color: green;"></div>
28	Fabric validation RailOptimized...	2022-04-28 17:16:08	2022-04-28 17:16:09	Completed With Errors	View Summary	<div style="width: 100%; height: 10px; background-color: red;"></div>
27	Fabric validation CheckSymbol...	2022-04-28 17:16:03	2022-04-28 17:16:05	Completed	View Summary	<div style="width: 100%; height: 10px; background-color: green;"></div>
26	Fabric validation CheckEffectiv...	2022-04-28 17:15:57	2022-04-28 17:15:59	Completed	View Summary	<div style="width: 100%; height: 10px; background-color: green;"></div>
25	Fabric validation CheckCables ...	2022-04-28 17:15:51	2022-04-28 17:15:52	Completed	View Summary	<div style="width: 100%; height: 10px; background-color: green;"></div>

Viewing 1-10 of 34

ID ↓ 1	Related Object	Description	Created ↓ 2	Last Update ↓ 3	Status	Summary	Progress
34.1	Site	running user defi...	2022-04-28 17:22:13	2022-04-28 17:22:16	Completed	View Summary	<div style="width: 100%; height: 10px; background-color: green;"></div>

9.8 Settings

All information provided in a tabular format in UFM web UI can be exported into a CSV file.

This window enables configuring the following UFM server and fabric-related settings:

- [Events Policy](#)
- [Device Access](#)
- [Network Management](#)
- [Subnet Manager Tab](#)
- [Non-Optimal Links](#)
- [User Management Tab](#)
- [Email](#)
- [Remote Location](#)
- [Data Streaming](#)
- [Topology Compare](#)
- [Token-based Authentication](#)
- [Plugin Management](#)
- [Rest Roles Access Control](#)
- [User Preferences](#)

9.8.1 Events Policy

The Events Policy tab allows you to define how and when events are triggered for effective troubleshooting and fabric maintenance.

Event	Category	Mail	GUI	Alarm	Syslog	Log File	SNMP	Threshold	TTLSec	Severity
GID Address In Service		<input type="checkbox"/>	<input checked="" type="checkbox"/>	<input type="checkbox"/>	<input type="checkbox"/>	<input checked="" type="checkbox"/>	<input type="checkbox"/>	1	300	Info
GID Address Out of Service		<input type="checkbox"/>	<input checked="" type="checkbox"/>	<input checked="" type="checkbox"/>	<input type="checkbox"/>	<input checked="" type="checkbox"/>	<input type="checkbox"/>	1	300	Warning
New MCast Group Created		<input type="checkbox"/>	<input checked="" type="checkbox"/>	<input type="checkbox"/>	<input type="checkbox"/>	<input checked="" type="checkbox"/>	<input type="checkbox"/>	1	300	Info
MCast Group Deleted		<input type="checkbox"/>	<input checked="" type="checkbox"/>	<input type="checkbox"/>	<input type="checkbox"/>	<input checked="" type="checkbox"/>	<input type="checkbox"/>	1	300	Info
Symbol Error		<input type="checkbox"/>	<input checked="" type="checkbox"/>	<input checked="" type="checkbox"/>	<input type="checkbox"/>	<input checked="" type="checkbox"/>	<input type="checkbox"/>	200	300	Warning
Link Error Recovery		<input type="checkbox"/>	<input checked="" type="checkbox"/>	<input checked="" type="checkbox"/>	<input type="checkbox"/>	<input checked="" type="checkbox"/>	<input type="checkbox"/>	1	300	Minor
Link Downed		<input type="checkbox"/>	<input checked="" type="checkbox"/>	<input checked="" type="checkbox"/>	<input type="checkbox"/>	<input checked="" type="checkbox"/>	<input type="checkbox"/>	0	300	Warning
Port Receive Errors		<input type="checkbox"/>	<input checked="" type="checkbox"/>	<input checked="" type="checkbox"/>	<input type="checkbox"/>	<input checked="" type="checkbox"/>	<input type="checkbox"/>	5	300	Warning
Port Receive Remote ...		<input type="checkbox"/>	<input checked="" type="checkbox"/>	<input type="checkbox"/>	<input type="checkbox"/>	<input checked="" type="checkbox"/>	<input type="checkbox"/>	5	300	Minor
Port Receive Switch R...		<input type="checkbox"/>	<input checked="" type="checkbox"/>	<input checked="" type="checkbox"/>	<input type="checkbox"/>	<input checked="" type="checkbox"/>	<input type="checkbox"/>	9999	300	Minor

Events are reported by setting the following parameters:

Option	Description/Instructions
Event	Event description.
Category	Event category, such as Communication Error and Hardware represented by icons.
Mail	When selected, the corresponding events will be sent a list of recipients according to Configuring Email-on-Events .
Web UI	When selected, the corresponding events are displayed in the Events & Alarms window in the Web UI.
Alarm	Select the Alarm option to trigger an alarm for a specific event. When selected, the alarms will appear in the Events & Alarms window in the Web UI.
Syslog	When checked along with the Log file option, the selected events will be written to Syslog.
Log File	Select the Log File option if you would like the selected event to be reported in a log file.
SNMP	The UFM Server will send events to third-party clients by means of SNMP traps. Select the event SNMP check box option to enable the system to send an SNMP trap for the specific event. The SNMP trap will be sent to the port defined in Configuration file located under: /opt/ufm/conf/gv.cfg. For further information, refer to SNMP Settings .
Threshold	An event will be triggered when the traffic/error rate exceeds the defined threshold. For example: when PortXmit Discards is set to 5 and the counter value grows by 5 units or more between two sequential reads, an event is generated.
TTL (Sec)	TTL (Alarm Time to Live) sets the time during which the alarm on the event is visible on UFM Web UI. TTL is defined in seconds. CAUTION: Setting the TTL to 0 makes the alarm permanent, meaning that the alarm does not disappear from the Web UI until cleared manually.
Action	The action that will be executed in case the event which has triggered the action can be none or isolated (make the port unhealthy or isolated). This attribute can be set only for ports event policy.
Severity	Select the severity level of the event and its alarm from the drop-down list: Info, Warning, Minor, and Critical.

➤ To set the SNMP properties:

1. Open the `/opt/ufm/conf/gv.cfg` configuration file.
2. Under the [Notifications] line (see the following example):
 - a. Set the (snmp_listeners) IP addresses and ports
 - b. Port is optional - the default port number is 162
 - c. Use a comma to separate multiple listeners

Format:

```
snmp_listeners = <IP Address 1>[:<port 1>][,<IP Address 2>[:<port 2>]...]
```

Example:

```
[Notifications]
snmp_listeners = host1, host2:166
```

9.8.1.3 Configuring Email-on-Events

UFM enables you to configure each event to be sent by email to a list of pre-defined recipients. Every 5 minutes (configurable) UFM will collect all “Mail” selected events and send them to the list of pre-defined recipients. By default, the maximum number of events which can be sent in a single email is 100 (configurable, should be in the range of 1-1000)

The order of events in the email body can be set as desired. The available options are: order by severity or order by time (by default: order by severity)

➤ To change email-on-events setting, do the following:

1. Edit the `/opt/ufm/conf/gv.cfg` file.
2. Go to section “[Events]” and set the relevant parameters:
 - `sending_interval` (default=5)—Time interval for keeping events (minimum 10 seconds, maximum 24 hours)
 - `sending_interval_unit` (default = minute)—Optional units: minute, second, hour
 - `cyclic_buffer` (default=false)—If the cyclic buffer is set to true, older events will be dropped, otherwise newer events will be dropped (if reaches max count)
 - `max_events` (default=100)—Maximum number of events to be sent in one mail (buffer size), should be in the range of 1-1000
 - `group_by_severity` (default=true)—Group events in mail by severity or by time

➤ To receive the email-on-events, do the following:

Configure SMTP settings under Settings window → Email tab - see [Email Tab](#).

1. Configure the Recipients List under Settings → Events Policy.

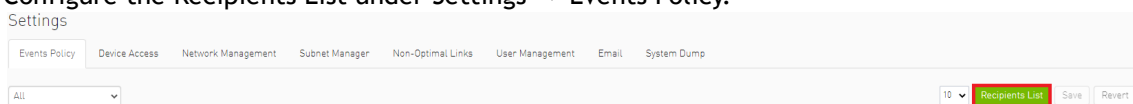

2. Click New.

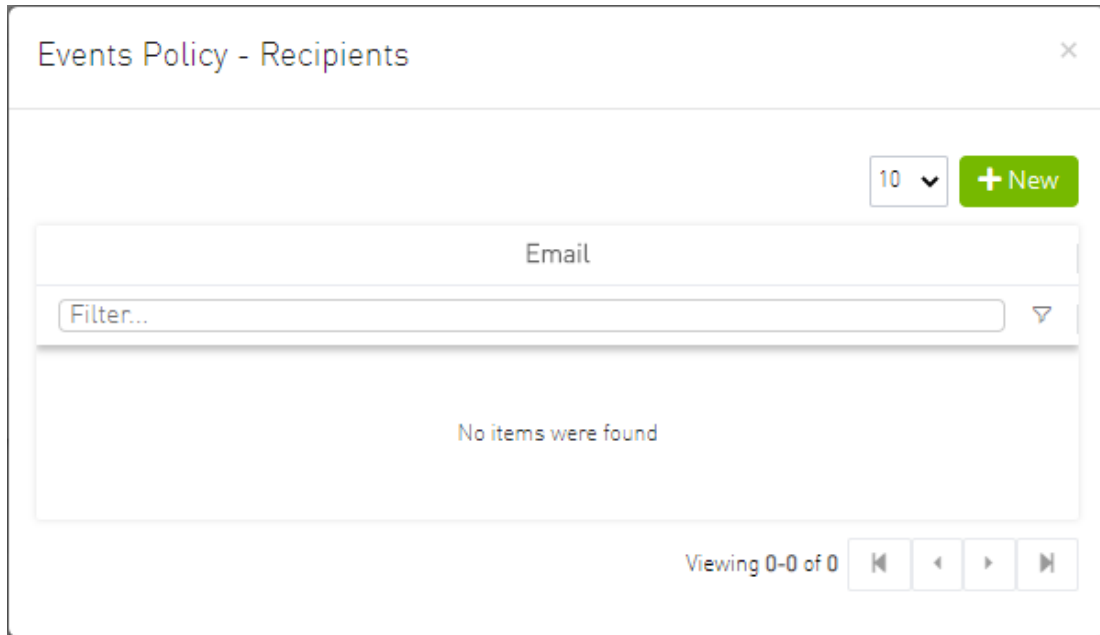

3. In the Recipients List window, enter valid recipient email addresses, comma-separated, and click Submit.

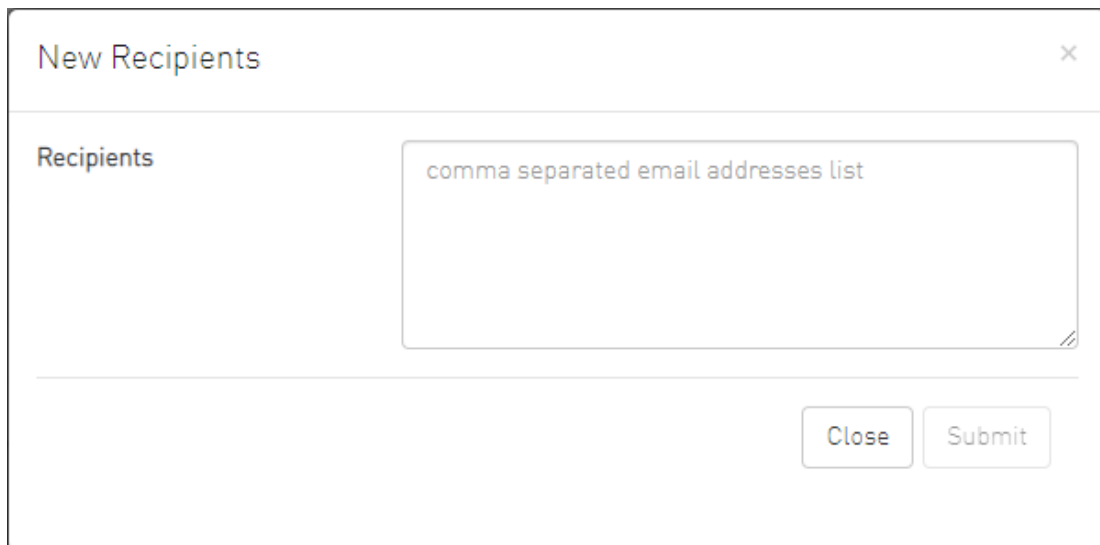

The new recipients are then added to the Events Policy Recipients list. These recipients automatically start receiving emails on the events for which the Mail checkbox is checked in the table under Events Policy.

9.8.2 Device Access

The screenshot shows the 'Settings' page in the NVIDIA UFM Enterprise interface. The 'Device Access' tab is selected. Under the 'HTTP' section, the following fields are visible:

- Credentials:**
 - User:
 - Password:
 - Confirmation:
- Connection:**
 - Port:
 - Timeout:

There is a checkbox labeled 'Save the current password as fallback' and an 'Update' button at the bottom right of the form.

You can configure default access parameters for remote administration via the following protocols:

- Switch SSH - allows you to define the SSH parameters to open an SSH session on your switch
 - Server SSH - allows you to define the SSH parameters to open an SSH session on your server
 - HTTP - allows you to define the HTTP parameters to open an HTTP session on your device
- Default credentials are applicable to all switches and servers in the fabric.

The default SSH (CLI) switch credentials match the Grid Director series switch. To change the credentials for IS5030/IS5035 edit the [SSH_Switch] section in the gv.cfg file.

Define access parameters for the remote user as described in the following table.

Site Access Credential Parameters

Parameter	Description
User	The name of the user allowed remote access.
Password	Enter the user password.
Confirmation	Re-enter the password.
Port	Each communication protocol has a default port for connection. You can modify the port number, if required.
Timeout	Each communication protocol has a default timeout, i.e. the maximum time, in seconds, to wait for a response from the peer. You can modify the timeout, if required.

Parameter	Description
Save the current password for fallback checkbox	This checkbox should be checked in case if you require the previous password to remain operational. This feature is beneficial during the period when the global switch password is changed for large-scale fabrics due to security considerations. It is only applicable for the MLNX_OS (HTTP) credentials type. By default, the value is set to false.

9.8.3 Network Management

UFM achieves maximum performance with latency-critical tasks by implementing traffic isolation, which minimizes cross-application interference by prioritizing traffic to ensure critical applications get the optimal service levels.

9.8.3.1 UFM Routing Protocols

UFM web UI supports the following routing engines:

- MINHOP - based on the minimum hops to each node where the path length is optimized (i.e., shortest path available).
- UPDN - also based on the minimum hops to each node but it is constrained to ranking rules. Select this algorithm if the subnet is not a pure Fat Tree topology and deadlock may occur due to a credit loops in the subnet.
- DNUP - similar to UPDN, but allows routing in fabrics that have some channel adapter (CA) nodes attached closer to the roots than some switch nodes.
- File-Based (FILE) - The FILE routing engine loads the LFTs from the specified file, with no reaction to real topology changes.
- Fat Tree - an algorithm that optimizes routing for congestion-free "shift" communication pattern.

Select Fat Tree algorithm if a subnet is a symmetrical or almost symmetrical fat-tree. The Fat Tree also optimizes K-ary-N-Trees by handling non-constant K in cases where leafs (CAs) are not fully staffed, and the algorithm also handles any Constant Bisectional Bandwidth (CBB) ratio. As with the UPDN routing algorithm, Fat Tree routing is constrained to ranking rules.

- Quasi Fat Tree - PQFT routing engine is a closed formula algorithm for two flavors of fat trees
- Quasi Fat Tree (QFT)
- Parallel Ports Generalized Fat Tree (PGFT)
PGFT topology may use parallel links between switches at adjacent levels, while QFT uses parallel links between adjacent switches in different sub-trees. The main motivation for that is the need for a topology that is not just optimized for a single large job but also for smaller concurrent jobs.
- Dimension Order Routing (DOR) - based on the Min Hop algorithm, but avoids port equalization, except for redundant links between the same two switches. The DOR algorithm provides deadlock-free routes for hypercubes, when the fabric is cabled as a hypercube and for meshes when cabled as a mesh.
- Torus-2QoS - designed for large-scale 2D/3D torus fabrics. In addition, you can configure Torus-2QoS routing to be *traffic aware*, and thus optimized for neighbor-based traffic.

- Routing Engine Chain (Chain) - an algorithm that allows configuring different routing engines on different parts of the IB fabric.
- Adaptive Routing (AR) - enables the switch to select the output port based on the port's load. This option is not available via UFM Web UI.
 - AR_UPDN
 - AR_FTREE
 - AR_TORUS
 - AR_DOR
- Dragonfly+ (DFP, DPF2)

9.8.3.2 Configuring Routing Protocol

Network Management tab enables setting the preferred routing protocol supported by the UFM software, as well as routing priority.

To set the desired routing protocol, move one routing protocol or more from the Available list to the Selected list, and click "Save" in the upper right corner.

Routing Information	
Lid Matrix Dump File	/opt/ufm/files/conf/opensm/lid_matrix.conf
LFTS File	/opt/ufm/files/conf/opensm/lfts.conf
Root Guid File	/opt/ufm/files/conf/opensm/root_guid.conf
Compute Nodes File	N/A
Node IDs File	N/A
Guid Routing Order File	N/A
Active Routing Engine	minhop

The protocol at the top of the list has the highest priority and will be chosen as the Active Routing Engine. If the settings for this protocol are not successful, UFM takes the next available protocol.

Routing Information is listed on the top of the screen:

Field/Box	Description
LID Matrix Dump File	File holding the LID matrix dump configuration
LFTS File	File holding the LFT routing configuration
Root GUID File	File holding the root node GUIDS (for fat-tree or Up/Down)
Compute Nodes File	File holding GUIDs of compute nodes for fat-tree routing algorithm
GUID Routing Order File	File holding the routing order GUIDs (for MinHop and Up/Down)
Node IDs File	File holding the node IDs
Active Routing Engine	The current active routing algorithm used by the managing OpenSM

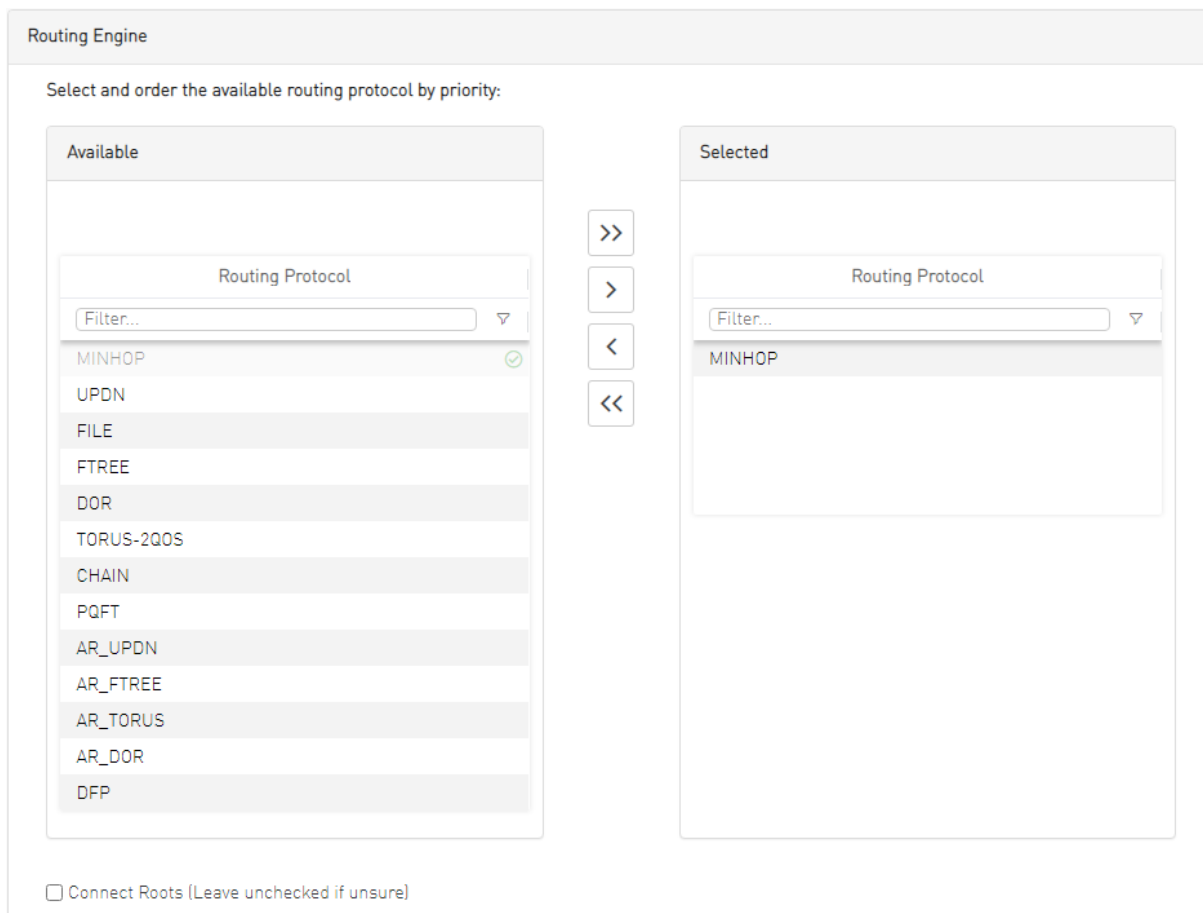

9.8.4 Subnet Manager Tab

UFM is a management platform using a user-space application for InfiniBand fabric management. This application is developed within the context of an open-source environment. This application serves as an InfiniBand Subnet Manager and a Subnet Administration tool.

The UFM Subnet Manager (SM) is a centralized entity running on the server that discovers and configures all the InfiniBand fabric devices to enable traffic flow throughout the fabric.

To view and configure SM parameters in the *Subnet Manager* tab, select the relevant tab according to the required configuration.

For more information, please refer to [Appendix - Enhanced Quality of Service](#).

9.8.4.1 SM Keys Configuration

The SM Keys tab enables you to view the Subnet Manager Keys. You cannot change the configuration in this tab.

Keys	MKey	0x 0
Limits	SA Key	0x 1
Lossy	Subnet Prefix	0x fe80000000000000
SL2VL	SM Key	0x 1
Sweep	MKey Lease Period	60 (sec)
Handover	LMC	0
Threading	No Partition Enforcement	false
Logging		
Misc		
QoS		
Congestion Control		
Adaptive Routing		

Field	Description	Default
MKey	A field that allows you to view or edit the M_Key value sent to all ports to qualify all the set (PortInfo). Authentication is performed by the management entity at the destination port and is achieved by comparing the key contained in the SMP with the key (the M_Key Management key) residing at the destination port.	0x0000000000000000
SA Key	Shows the SM_Key value to qualify the receive SA queries as 'trusted'.	0x0000000000000001
Subnet Prefix	An identifier of the subnet. The subnet prefix is used as the most significant 64 bit of the GID of each InfiniBand node in the subnet.	0xfe80000000000000
SM Key	Read-only field that displays the Key of the Subnet Manager (SM).	0x0000000000000001
MKey Lease Period	A field that allows you to view or edit the lease period used for the M_Key on this subnet in [sec].	0
LMC	Defines the LID Mask Control value for the SM. Possible values are 0 to 7. LID Mask Control (LMC) allows you to assign more than one LID per port. NOTE: Changes to the LMC parameter require a UFM restart.	0
No Partition Enforcement	Disables partition enforcement by switches.	Disabled

9.8.4.2 SM Limits Configuration

The SM Limits tab enables you to view and set the Subnet Manager Limits.

Keys	Packet Life Time	0x 12
Limits	Subnet Timeout	18
Lossy	Maximal Operational VL	VL0-VL3
SL2VL	Head Of Queue Life Time	0x 12
Sweep	Leaf Head Of Queue Life Time	0x 10
Handover	VL Stall Count	0x 7
Threading	Leaf VL Stall Count	0x 7
Logging	Force Link Speed	Max Supported
Misc	Local Physical Error Threshold	0x 8
QoS	Overrun Errors Threshold	0x 8
Congestion Control		
Adaptive Routing		

To configure SM Limits, set the fields as described in the table below, and click “Save.”

Field	Description	Default
Packet Life Time	A field that allows you to view and/or edit the code of maximum lifetime a packet in a switch. The actual time is $4.096 \text{ usec} * 2^{\langle \text{packet_life_time} \rangle}$. The value 0x14 disables this mechanism	0x12
Subnet Timeout	A field that allows you to view and/or edit the subnet_timeout code that will be set for all the ports. The actual timeout is $4.096 \text{ usec} * 2^{\langle \text{subnet_timeout} \rangle}$	18
Maximal Operational VL	A field that allows you to view and/or edit the limit of the maximal operational VLS: <ul style="list-style-type: none"> • 0: NO_CHANGE • 1: VL0 1 • 2: VL0_VL1 • 3: VL0_VL3 • 4: VL0_VL7 • 5: VL0_VL14 	3
Head of Queue Life Time	A field that allows you to view and/or edit the code of maximal time a packet can wait at the head of transmission queue. The actual time is $4.096 \text{ usec} * 2^{\langle \text{head of queue lifetime} \rangle}$. The value 0x14 disables this mechanism.	0x12
Leaf Head of Queue Life Time	A field that allows you to view and/or edit the maximum time a packet can wait at the head of queue on a switch port connected to a CA or gateway port.	0x10
VL Stall Count	A field that allows you to view the number of sequential packets dropped that cause the port to enter the VLStalled state. The result of setting this value to zero is undefined.	0x07

Field	Description	Default
Leaf VL Stall Count	This field allows you to view the number of sequential packets dropped that cause the port to enter the VLStalled state. This value is for switch ports driving a CA or gateway port. The result of setting the parameter to zero is undefined.	0x07
Force Link Speed	A parameter that allows you to modify the PortInfo:LinkSpeedEnabled field on switch ports. If 0, do not modify. <ul style="list-style-type: none"> Values are: 1: 2.5 Gbps 3: 2.5 or 5.0 Gbps 5: 2.5 or 10.0 Gbps 7: 2.5 or 5.0 or 10.0 Gbps 2,4,6,8-14 Reserved 15: set to PortInfo:LinkSpeedSupported 	15 By default, UFM sets the enabled link speed equal to the supported link speed.
Local Physical Error Threshold	A field that allows you to view and/or edit the threshold of local phy errors for sending Trap 129.	0x08
Overrun Errors Threshold	A field that allows you to view and/or edit the threshold of credit overrun errors for sending Trap 130.	0x08

9.8.4.3 SM Lossy Manager Configuration

This tab is available to users with an advanced license only.

The SM Lossy tab enables you to view and set the Lossy Configuration Manager options after Lossy Configuration has been enabled.

9.8.4.4 SM SL2VL Mapping Configuration

The SM SL2VL tab enables you to view the SL (service level) to VL (virtual lane) mappings and the configured Lossy Management. You cannot change the configuration in this tab.

However, you can change it in the previous [SM Lossy Manager Configuration \(Advanced License only\)](#) tab.

Keys	
Limits	
Lossy	
SL2VL	
Sweep	
Handover	
Threading	
Logging	
Misc	
QoS	
Congestion Control	
Adaptive Routing	

Qos Option Type	SL0	SL1	SL2	SL3	SL4	SL5	SL6	SL7
Default	0	1	2	3	0	1	2	3
Hca	0	1	2	3	0	1	2	3
Switch Port 0	0	1	2	3	0	1	2	3
Switch External Ports	0	1	2	3	0	1	2	3
Router	0	1	2	3	0	1	2	3

9.8.4.5 SM Sweep Configuration

The Sweep tab enables you to view and/or set the Subnet Manager Sweep Configuration parameters.

Keys	Sweep Interval	<input type="text" value="10"/>	seconds
Limits	Reassign Lids	<input type="checkbox"/>	
Lossy	Sweep On Trap	<input checked="" type="checkbox"/>	
SL2VL	Force Heavy Sweep	false	
Sweep			
Handover			
Threading			
Logging			
Misc			
QoS			
Congestion Control			
Adaptive Routing			

To configure SM Sweep, set the fields as described in the table below and click "Save."

Field/Box	Description	Default
Sweep Interval	A field that allows you to view and/or edit the number of seconds between light sweeps (0 disables it).	10
Reassign LIDs	If enabled, causes all LIDs to be reassigned.	Disabled
Sweep on Trap	If enabled, traps 128 and 144 will cause a heavy sweep.	Enabled
Force Heavy Sweep	If enabled, forces every sweep to be a heavy sweep.	Disabled

9.8.4.6 SM Handover Configuration

The SM Handover tab enables you to view the Subnet Manager Handover Configuration parameters. You cannot change the configuration in this tab.

Field/Box	Description	Default
SM Priority	A field that shows the SM priority used for determining the master. Range is 0 (lowest priority) to 15 (highest). Note: Currently, these settings may not be changed.	15
Polling Timeout	A field that shows the timeout in [sec] between two polls of active master SM.	Range=10000
Polling Retries	Number of failing polls of remote SM that declares it "not operational."	4
Honor GUID to LID File	If enabled, honor the guid2lid file when coming out of standby state, if the file exists and is valid.	Disabled
Ignore other SMs	If enabled, other SMs on the subnet are ignored.	Disabled

9.8.4.7 SM Threading Configuration

The SM Threading tab enables you to view the Subnet Manager Timing and Threading Configuration parameters. You cannot change the configuration in this tab.

Keys	Max Wire SMPs	8
Limits	Transaction Timeout	200 (ms)
Lossy	Max Message FIFO Timeout	10000
SL2VL	Single Thread	false
Sweep		
Handover		
Threading		
Logging		
Misc		
QoS		
Congestion Control		
Adaptive Routing		

Field/Box	Description	Default
Max Wire SMPs	A field that shows the maximum number of SMPs sent in parallel.	4
Transaction Timeout	A field that shows the maximum time in [msec] allowed for a transaction to complete.	200
Max Message FIFO Timeout	A field that shows the maximum time in [msec] a message can stay in the incoming message queue.	10000
Single Thread	When enabled, a single thread is used for handling SA queries.	Disabled

9.8.4.8 SM Logging Configuration

The SM Logging tab enables you to view and/or set the Subnet Manager Logging Configuration parameters.

Keys	Log File	/opt/ufm/files/log/opensm.log
Limits	Log Max Value	<input type="text" value="4096"/> (MB)
Lossy	Dump Files Directory	/opt/ufm/files/log/
SL2VL	Force Log Flush	<input type="checkbox"/>
Sweep	Accumulate Log File	<input checked="" type="checkbox"/>
Handover	Log Levels	<input checked="" type="checkbox"/> Error <input checked="" type="checkbox"/> Info <input type="checkbox"/> Verbose <input type="checkbox"/> Debug <input type="checkbox"/> Funcs <input type="checkbox"/> Frames <input type="checkbox"/> Routing <input type="checkbox"/> Sys
Threading		
Logging		
Misc		
QoS		
Congestion Control		
Adaptive Routing		

To configure SM Logging, set the fields as described in the table below and click “Save.”

Field/Box	Description	Default
Log File	Path of the Log file to be used.	cond/opt/ufm/files/log/opensm.log
Log Max Size	A field that allows you to view and/or edit the size limit of the log file in MB. If overrun, the log is restarted.	4096
Dump Files Directory	The directory that holds the SM dump file.	/opt/ufm/files/log
Force Log Flush	Force flush to the log file for each log message.	Disabled
Accumulate Log File	If enabled, the log accumulates over multiple SM sessions.	Enabled
Log Levels	Available log levels: Error, Info, Verbose, Debug, Funcs, Frames, Routing, and Sys.	Error and Info

9.8.4.9 SM Miscellaneous Settings

The Misc tab enables you to view additional Subnet Manager Configuration parameters. You cannot change the configuration in this tab.

Keys	Node Names Map File	N/A
Limits	SA Database File	N/A
Lossy	No Clients Reregistration	false
SL2VL	Disable MultiCast	false
Sweep	Exit On Fatal Event	true
Handover		
Threading		
Logging		
Misc		
QoS		
Congestion Control		
Adaptive Routing		

Field/Box	Description	Default
Node Names Map File	A field that allows you to view and/or set the node name map for mapping nodes to more descriptive node descriptions.	None
SA Database File	SA database file name	None
No Clients Reregistration	If enabled, disables client re-registration.	Disabled
Disable Multicast	If enabled, the SM disables multicast support and no multicast routing is performed.	Disabled
Exit on Fatal Event	If enabled, the SM exits on fatal initialization issues.	Enabled

9.8.4.10 SM QoS Configuration

The QoS tab allows you to enable or disable QoS functionality. QoS is disabled by default.

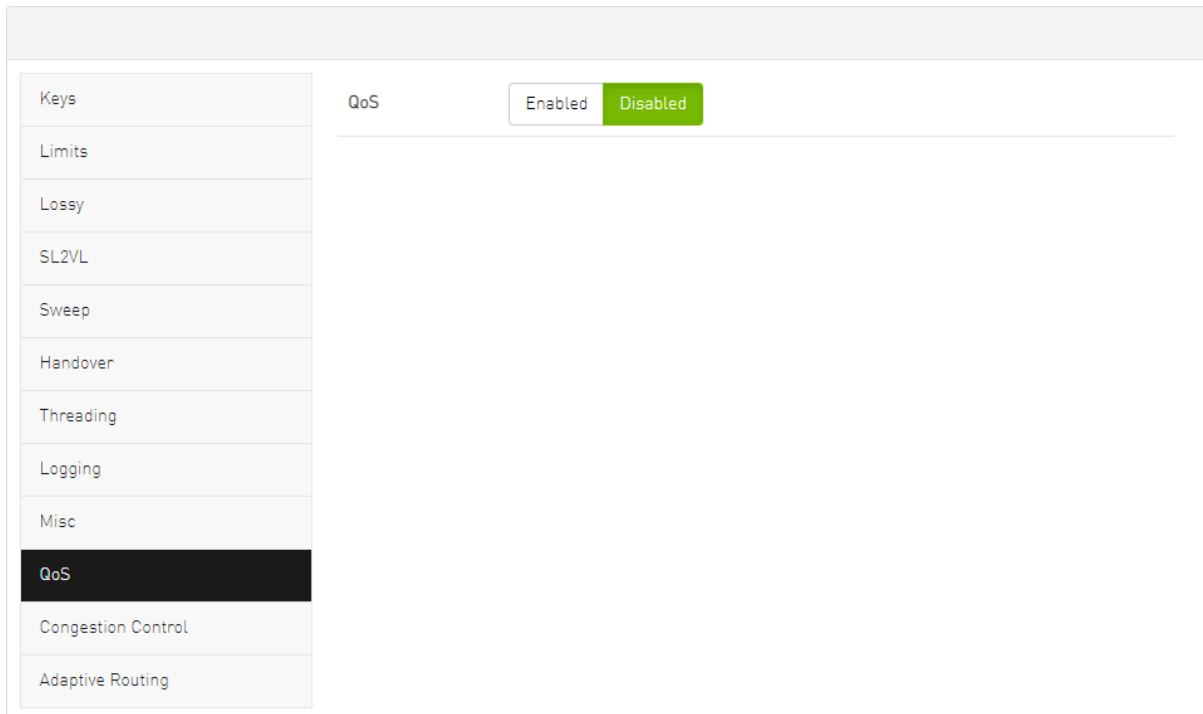

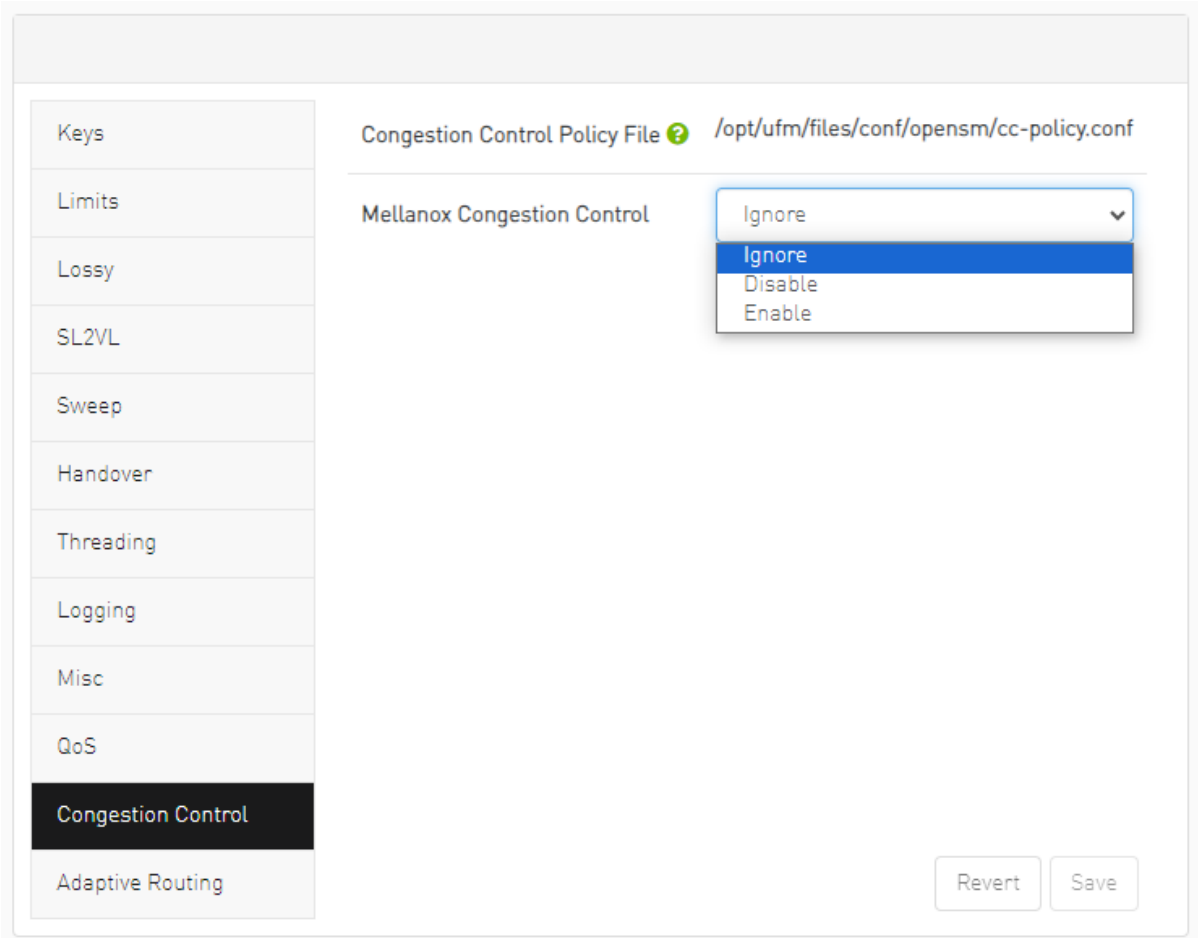

9.8.4.11 SM Congestion Control Configuration

The Congestion Control tab allows you to enable, disable, or ignore congestion control.



9.8.4.12 SM Adaptive Routing Configuration

The Adaptive Routing tab allows you to configure adaptive routing parameters.

Keys	DFP Down Up Turns Mode 	<input type="text" value="0"/>
Limits		
Lossy	DFP Max Cas On Spine 	<input type="text" value="2"/>
SL2VL		
Sweep	Adaptive Routing SL Mask 	<input type="text" value="0x FFFF"/>
Handover		
Threading		
Logging		
Misc		
QoS		
Congestion Control		
Adaptive Routing		

9.8.5 Non-Optimal Links

A non-optimal link is a link between two ports that is configured to operate at a certain speed and width and is operating at a lower rate. The Non-optimal links feature helps you identify potential link failures and reduce fabric inefficiencies.

Non-optimal links can be any of the following:

- NDR links that operate in HDR, EDR, FDR, QDR, DDR or SDR mode
- HDR links that operate in EDR, FDR, QDR, DDR or SDR mode
- EDR links that operate in FDR, QDR, DDR or SDR mode
- FDR links that operate in QDR, DDR or SDR mode
- QDR links that operate in DDR or SDR mode
- 4X links that operate in 1X mode

The Non-Optimal Links window allows you to set the preferred action for non-optimal links.

To set the non-optimal links policy:

From the drop-down menu, select the action for Non-optimal Links behavior.

The drop-down menu defines the default behavior. Options are: Ignore (default), Disable, and Reset.

Option	Description
Ignore	Ignore the non-optimal links
Reset	Reset all non-optimal links ports
Disable	Disable all non-optimal links ports

Reset all Non-Optimal Links allows users to reset all current non-optimal links ports on-demand.

Disable all Non-Optimal Links allows users to disable all current non-optimal links ports on-demand.

9.8.6 User Management Tab

UFM User Authentication is based on standard Apache User Authentication. Each Web Service client application must authenticate against the UFM Server to gain access to the system. UFM implements any kind of third-party authentication supported by the Apache Web Server.

The default user (admin) has System Administration rights. A user with system Administration rights can manage other users' accounts, including creation, deletion, and modification of accounts. The system's default user is the admin user.

 To add a new user account, do the following:

1. Click the “New” button.

The screenshot shows a web interface with a top navigation bar containing tabs: Events Policy, Device Access (selected), Network Management, Subnet Manager, Non-Optimal Links, and User Management. Below the navigation bar are links for Topology Compare and Access Tokens. The main content area features a '+ New' button and a 'Displayed Columns' dropdown. A table with columns 'ID', 'Name', and 'Group' is displayed. The table contains one row with the following data:

ID ↓	Name	Group
1	admin	System Admin

At the bottom of the table, there are filter boxes for each column and a pagination control showing 'Viewing 1-1 of 1' with navigation arrows and a page size dropdown set to 10.

2. Fill in the required fields in the dialog box.

The 'Create A User' dialog box contains the following fields:

- User Name:
- Group: (dropdown menu)
- Password:
- Confirm Password:

A green 'Create' button is located at the bottom right of the dialog box.

Each user can be assigned to one of the following Group (role) options:

- System Admin - users can perform all operations including managing other users accounts.
- Fabric Admin - users can perform fabric administrator actions such as update SM configuration, update global credentials, manage reports, managing unhealthy ports, and manage PKeys, etc.
- Fabric Operator - users can perform fabric operator actions such as device management actions (enable/disable port, add/remove devices to/from groups, reboot device, upgrade software, etc.)
- Monitoring Only - users can perform monitoring actions such as view the fabric configuration, open monitoring sessions, define monitoring templates, and export monitoring data to CSV files, etc.

To edit existing users accounts, right-click the account from the list of user accounts and perform the desired action (Change Password/Remove).

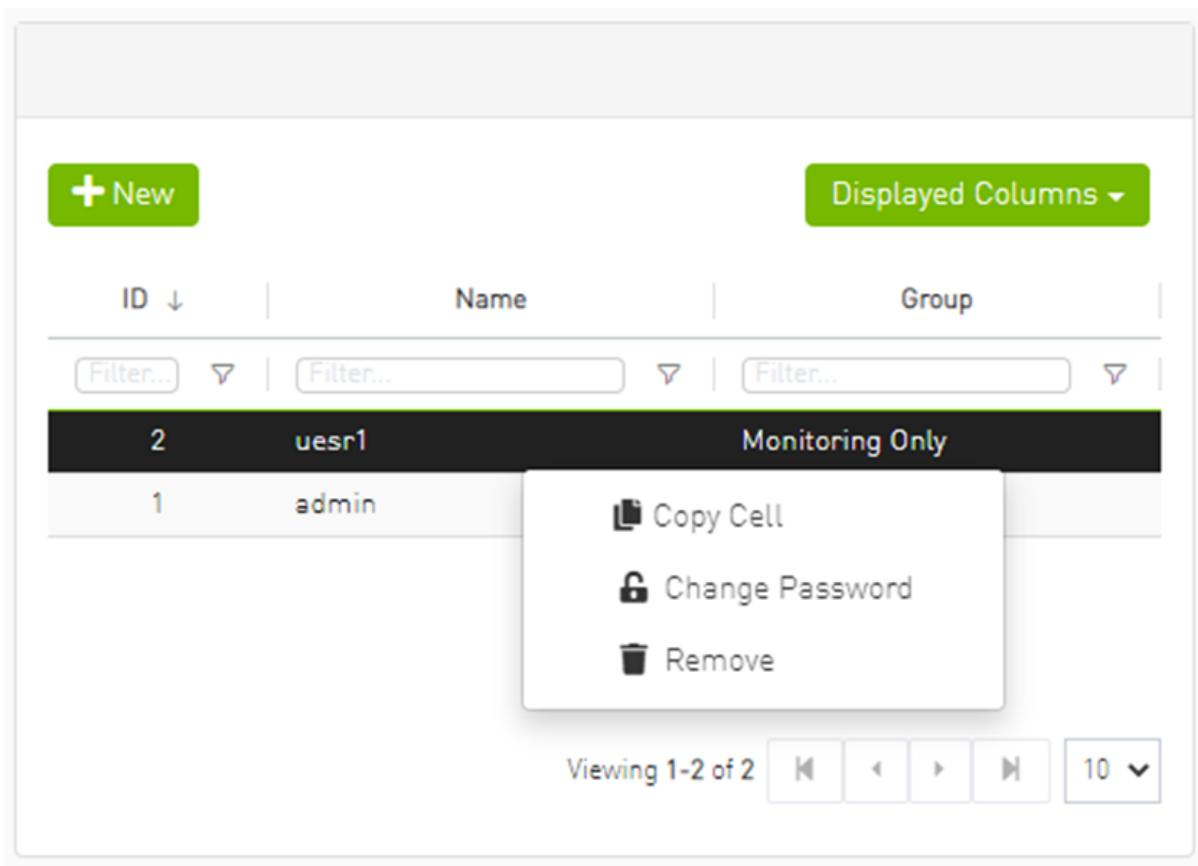

9.8.7 Email

SMTP configuration is required to set both the [Daily Reports Tab](#) and the Email-on-Events features.

1. In the SMTP Configuration dialogue window, enter the following information:

Settings

Events Policy Device Access Network Management Subnet Manager Non-Optimal Links User Management

Plugin Management

SMTP Configurations

SMTP Server

SMTP Port

Sender Name

Sender Address

Timezone

Use Authentication

Use SSL

Username

Password

Attribute	Description
SMTP Server	The IP or host name of the SMTP server. Examples: <ul style="list-style-type: none"> If mail service is installed, localhost is a valid value for this field, but usually it cannot send mails outside the local domain. smtp.gmail.com
SMTP Port	Default value - 25
Sender Name	The name that will be displayed in the email header
Sender Address	A valid email address that will be displayed in the email header
Time Zone	The default time zone for receiving sent emails is the server time zone. Users have the option to specify a different preferable time zone
Use Authentication	By default, this field is unchecked. If checked, you must supply a username and password in the respective fields
Use SSL	Default value is false - not using SSL
Username	SMTP account username

Attribute	Description
Password	SMTP account password

- Click "Save." All configuration of the SMTP server will be saved in the UFM Database. Click "Send Test Email" to test the configuration and the following model will appear:

Attribute	Description
Recipients	User can choose email from event policy and daily report recipients or enter any email
Subject	Email subject
Message	Email message

The System Health window enables running and viewing reports and logs for monitoring and analyzing UFM server and fabric health through the following tabs: UFM Health, UFM Logs, UFM Snapshot, Fabric Health, Daily Reports and Topology Compare.

9.8.8 Remote Location

Remote location tab is used to set a predefined remote location for the results of System Dump action on switches and hosts and for IBDiagnet executions.

Events Policy Device Access Network Management Subnet Manager Non-Optimal Links User Management Email Remote Location Data Stream

Remote Location

Protocol

Remote location is used to save result of System Dump and IBDiagnet.
By default this location will be used.
Path: N/A

Server

Path

Username

Password

Field	Description
Protocol	The protocol to use to move the dump file to the external storage (scp/sftp)
Server	Hostname or IP address of the server
Path	The path where dump files are saved
Username	Username for the server
Password	Respective password

After configuring these parameters, it would be possible for users to collect sysdumps for specific devices, groups, or links (through Network Map/Cables Window) by right-clicking the item and selecting System Dump.

9.8.9 Data Streaming

This section allows users to configure System Logs (syslog) streaming settings via web UI.

Data Streaming Configurations

System Logs

Status
 Disabled Enabled

Mode
 Local Remote

Destination
 :

System logs level

Streaming Data

UFM logs

REST API logs

Authentication service logs

Event

Follow Events policy

Stream All Events

Field	Description
Status	Enable/disable exporting UFM logs to syslog
Mode	Export logs to local or remote syslog
Destination	Remote server IP/hostname and port in case of the remote mode
System Logs Level	Sets global syslog messages logging level. The syslog level is common for all the UFM components. The syslog level that is sent to syslog is the highest among the syslog level and component log level as defined in the config file.
Streaming Data	<p>Logs to export to system logs.</p> <div style="border: 1px solid #ffc107; padding: 5px; margin-bottom: 5px;"> <p>Events logs are selected one by one from Events Policy settings when the system logs feature is enabled.</p> </div> <div style="border: 1px solid #ffc107; padding: 5px;"> <p>Authentication service logs will be only available in case the Authentication Service is enabled</p> </div>

9.8.10 Topology Compare

This tab controls the settings for the [Periodic Topology Comparison](#) feature.

Events Policy Device Access Network Management Subnet Manager Non-Optimal Links User Management Email Remote Location Data Streaming Topology Compare

Topology Compare Settings

Comparison Interval (For comparing the current topology with master topology)

Days

Stable Topology Period (For offering user to update the master topology for comparison)

Hours

- Comparison Interval - determines how often the current topology is compared against the master topology
- Stable Topology Period - determines how long a topology must be stable before it is designated the new master topology

9.8.11 Token-based Authentication

Token-based authentication is a protocol which allows users to verify their identity, and in return receive a unique access token. During the life of the token, users then access the UFM APIs that the token has been issued for, rather than having to re-enter credentials each time they need to use any UFM API.

Under the Settings section there is a tab titled called “Access Tokens”.

The functionality of the added tab is to give the user the ability to create new tokens & manage the existing ones (list, copy, revoke, delete):



Access Tokens

Access Token	Issued At ↓	Actions
<input type="text" value="Filter..."/>	<input type="text" value="Filter..."/>	
TZhcEdLFHpkRdC9DBdwK9A9iajyJ0m	2022-04-28 17:34:41	<input type="button" value="x"/> <input type="button" value="🗑️"/> <input type="button" value="📄"/>
tb5s5gfp68LeTx09m70tFPs6DN9cqV	2022-04-28 17:34:40	<input type="button" value="x"/> <input type="button" value="🗑️"/> <input type="button" value="📄"/>
nINcqmR8gdroFhBLBGcAJV7movZgR4	2022-04-28 17:34:39	<input type="button" value="x"/> <input type="button" value="🗑️"/> <input type="button" value="📄"/>

Viewing 1-3 of 3

Actions:

Name	Icon	Description
Revoke		Revoke a specific token. <div style="border: 1px solid #ccc; padding: 5px; margin-top: 5px;">The revoked token will no longer be valid.</div>

Name	Icon	Description
Delete		Delete a specific token.
Copy		Copy specific token into the clipboard.

Each user is able to list and manage only the tokens that have been created by themselves. Only the users with `system_admin` role will be able to create tokens.

9.8.12 Plugin Management

Plugin management allows users to manage UFM plugins without using CLI commands. Under "Settings", there is a tab titled "Plugin Management".

The functionality of the "Plugin Management" tab is to give the user the ability to add, remove, disable and enable plugins.

Furthermore, the plugin management feature allows loading a plugin's image in two ways: either by remotely pulling it from a Docker Hub repository or by directly uploading the image file from the user's local machine.

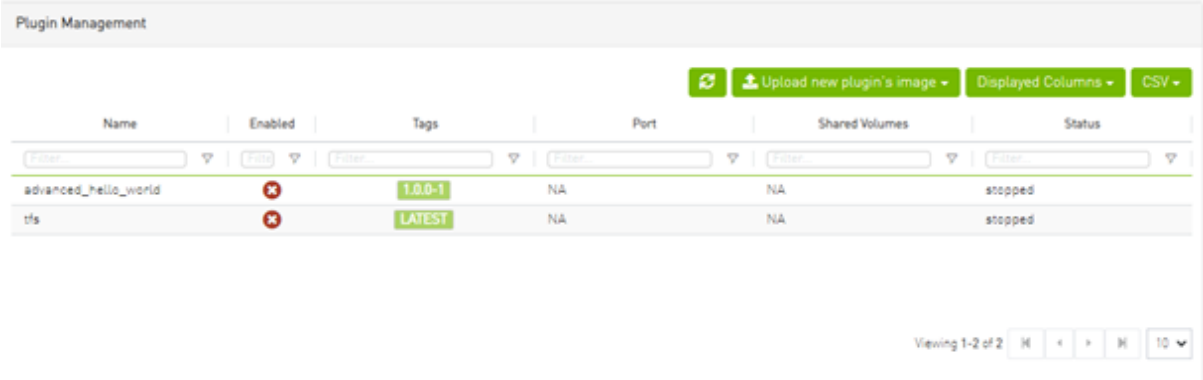

Plugin Management

Refresh Upload new plugin's image Displayed Columns CSV

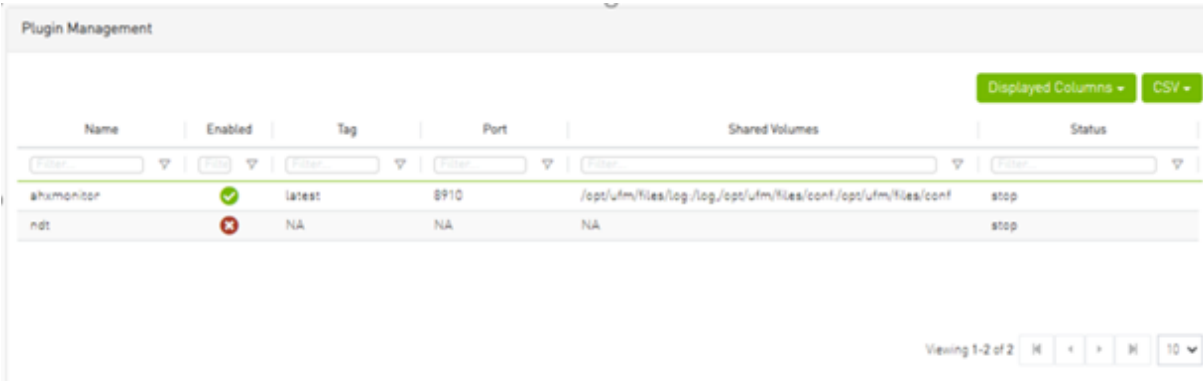

Name	Enabled	Tags	Port	Shared Volumes	Status
advanced_hello_world		1.0.0-1	NA	NA	stopped
tfs		LATEST	NA	NA	stopped

Viewing 1-2 of 2



Plugin Management

Displayed Columns CSV

Name	Enabled	Tag	Port	Shared Volumes	Status
akumonitor		latest	8910	/opt/ufm/files/log/log/opt/ufm/files/conf/opt/ufm/files/conf	stop
ndt		NA	NA	NA	stop

Viewing 1-2 of 2

Actions:

- Add - Used to add a selected plugin, opens a modal to select the needed tag.

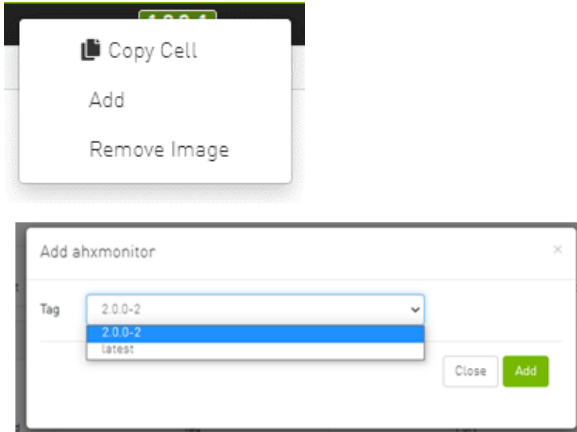

- Remove - Used to remove a selected plugin.

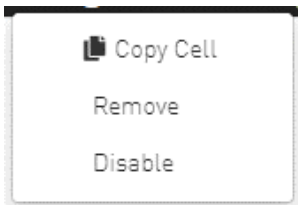

- Disable - Used to disable a selected plugin, so the plugin is disabled once the UFM is disabled.

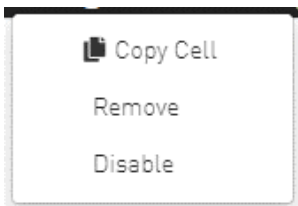

- Enable - Used to enable a selected plugin, so the plugin is enabled once the UFM is enabled.

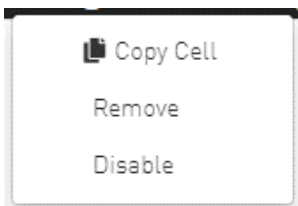

- Add ahxmonitor - Used to add a selected plugin; the action opens a modal to select the requested tag.



- Remove plugin Image - Used to remove plugin image

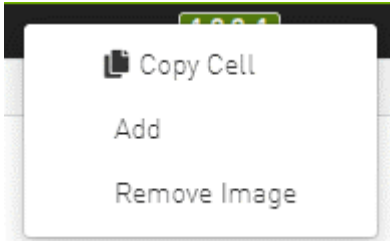

If the high availability (HA) mode is enabled, the user will see the option to remove the image from the standby node as well.

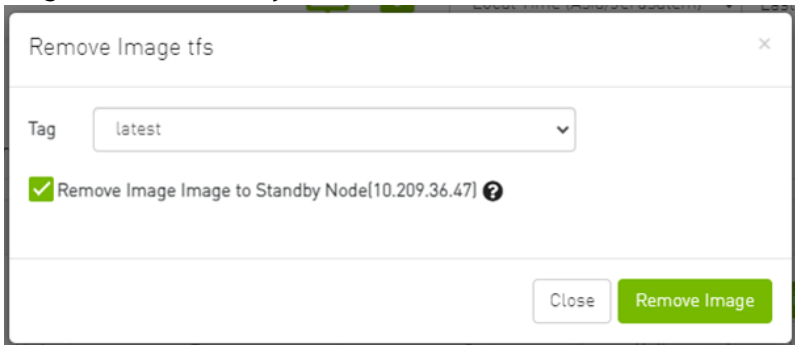

In cases where there is no established trust communication between the master and standby nodes, the user will be required to provide a username and password to establish an SSH connection between them.

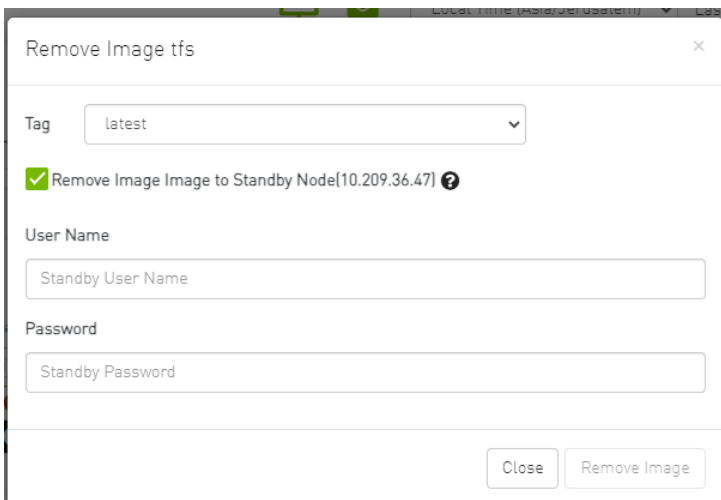

- Pull plugin Image - Used to pull plugin image remotely (e.g. from a Docker Hub repository) or by loading it from user local machine by uploading the image file itself.

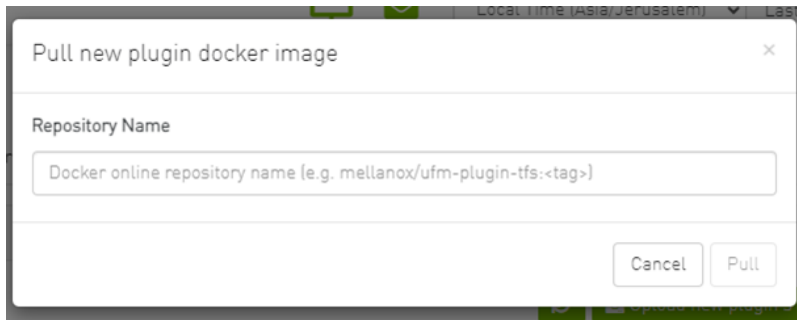

If the high availability (HA) mode is active, the user will be presented with the choice to pull the image to the standby node as well.



Once again, in the absence of trusted communication between the master and standby nodes, the user will need to input a username and password to create an SSH connection between the nodes.

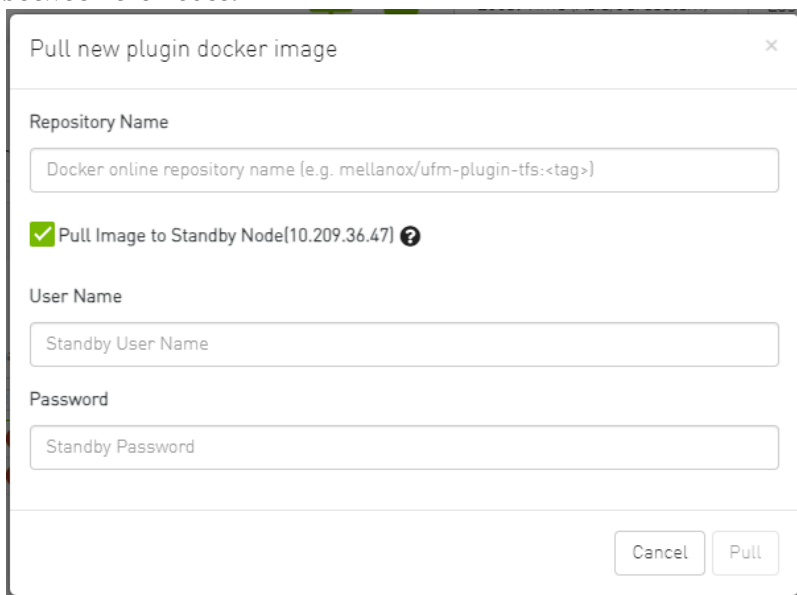

- Load plugin Image: this feature allows the user to upload the image file from their local machine directly.

Similarly, if the high availability (HA) mode is enabled, the user will have the option to load the image to the standby node too.

And, as mentioned earlier, if there is no trusted communication between the master and standby node, the user will need to provide a username and password to establish an SSH connection between the nodes.

9.8.13 Rest Roles Access Control

In UFM, there are four predefined roles with the following corresponding values:

1. System Admin (Role value: 5)
2. Fabric Admin (Role value: 4)
3. Fabric Operator (Role value: 3)

4. Monitoring Only (Role value: 2)

For more information, refer to the [User Management Tab](#).

The "Rest Roles Access Control" tab empowers Admin users to design their custom roles alongside the existing predefined roles. Admins can set permissions and access levels for these custom roles, defining which APIs the roles can access.

Roles are presented in a table format, with the predefined roles highlighted in yellow.

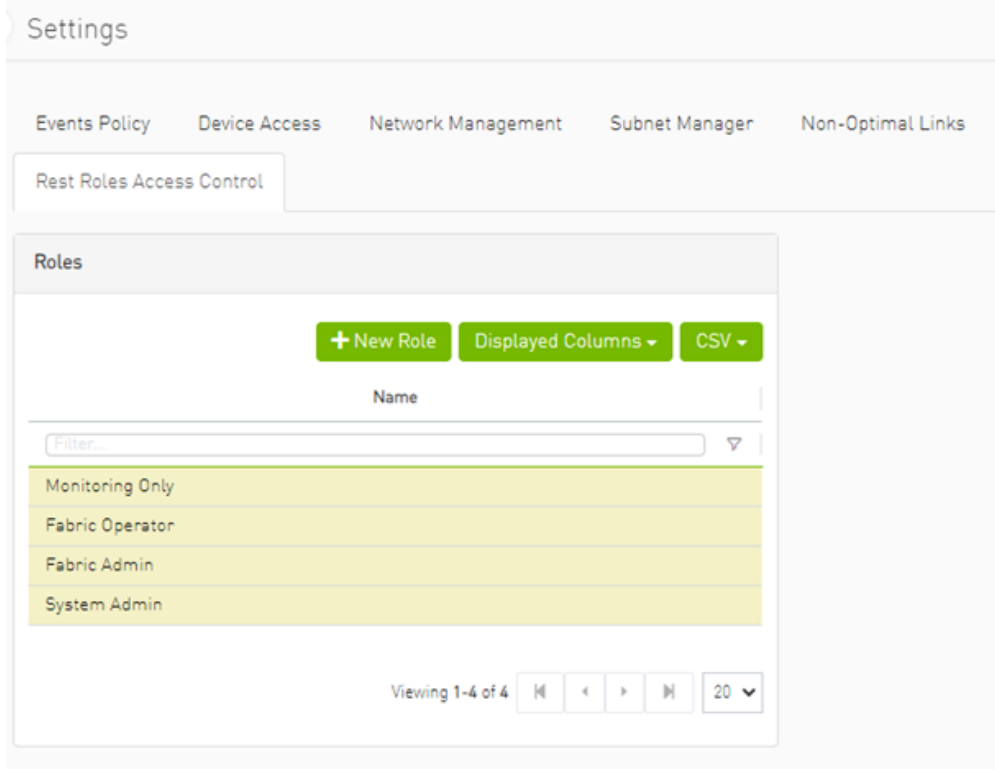

This tab is exclusively available to System_Admin users and can be enabled or disabled through the `gv.cfg` file. By default, it is enabled.

9.8.13.1 Adding a New Role

1. Click the **+ New Role** button.

2. Fill in the necessary details in the dialog box.

The screenshot shows a 'New Role' dialog box with a 'Name' field containing 'Role name'. Below are two panels: 'Denied' and 'Allowed'. The 'Denied' panel contains a table with 8 rows of URL and Method pairs. The 'Allowed' panel is empty, showing 'No items were found'. A 'Create' button is at the bottom right.

URL	Method
/monitoring/start	POST
/monitoring/session/<se...	PUT
/monitoring/session/<se...	DELETE
/monitoring/session/<se...	GET
/monitoring/session/<se...	GET
/monitoring/snapshot	POST
/monitoring/session/<se...	GET
/monitoring/attributes	GET

By default, all URLs are denied. To allow specific URLs for this role, move them to the "allowed" category.

9.8.13.2 Updating Custom Roles

1. Select the role that requires updating.

The screenshot displays the REST API management console interface. At the top, there are navigation tabs for various services: Events Policy, Device Access, Network Management, Subnet Manager, Non-Optimal Links, User Management, Email, Remote Location, and Data Streaming. Below these are sub-tabs: Topology Compare, Access Tokens, Plugin Management, and Rest Roles Access Control. The main content area is divided into two panels. The left panel, titled 'Roles', contains a '+ New Role' button, 'Displayed Columns' and 'CSV' options, a search bar, and a list of roles: Monitoring Only, Fabric Operator, Fabric Admin, System Admin, and Read_only (which is highlighted). The right panel, titled 'Read_only - Information', shows the role's configuration. It includes a 'Name' field with 'Read_only' entered. Below this are two tables: 'Denied' and 'Allowed'. The 'Denied' table lists several URLs and methods with green checkmarks, indicating they are denied. The 'Allowed' table lists several URLs and methods with greyed-out entries, indicating they are not allowed. Navigation arrows are present between the two tables. At the bottom right of the 'Read_only - Information' panel is an 'Update' button.

2. Modify the allowed list from the role information section.

9.8.13.3 Deleting Custom Roles

1. Right-click on the role that needs deletion.

2. Choose the "Delete" option from the context menu.

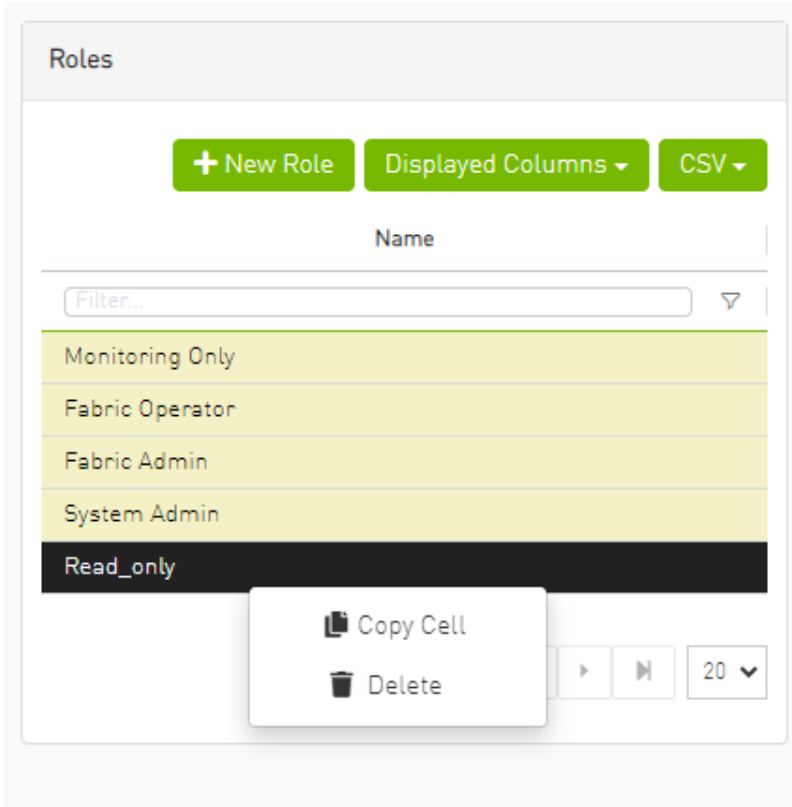

Deleting and updating predefined roles is not permitted.

9.8.13.4 Creating a User with a Custom Role

1. Navigate to the Users Management tab.
2. Create a new user, and you will find all roles (both custom and predefined) listed under the group list.

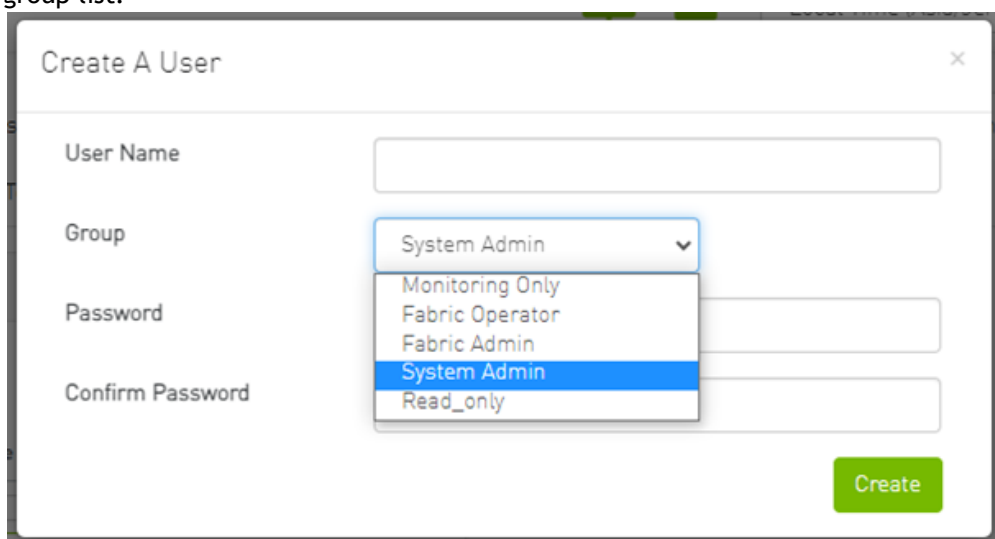

9.8.14 User Preferences

This page allows user to change UI preferences in general.

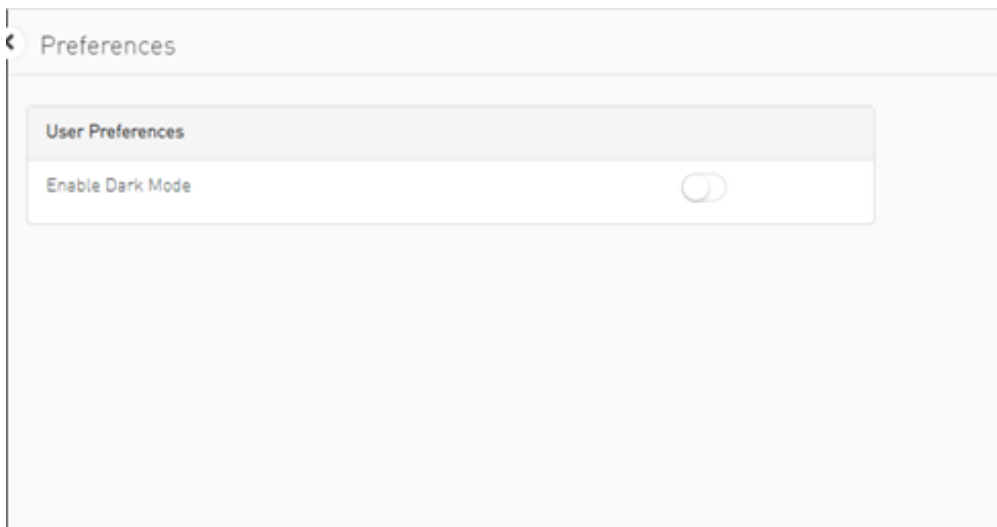
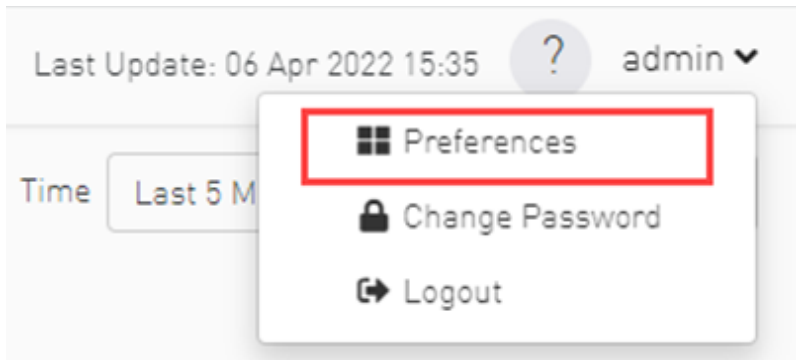

When user enables dark mode, the UFM is presented in dark theme.

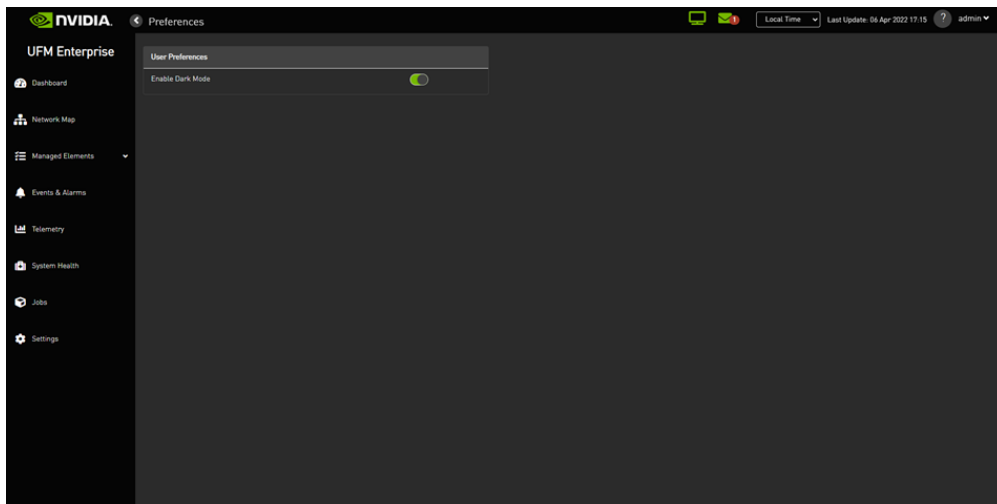

10 Multi-Subnet UFM

10.1 Overview

The Multi-Subnet UFM feature allows for the management of large fabrics, consisting of multiple sites, within a single product, namely Multi-Subnet UFM.

This feature is comprised of two layers: UFM Multi-Subnet Provider and UFM Multi-Subnet Consumer.

The UFM Provider functions as a Multi-Subnet Provider, exposing all local InfiniBand fabric information to the UFM consumer. On the other hand, the UFM Consumer acts as a Multi-Subnet Consumer, collecting and aggregating data from currently configured UFM Providers, enabling users to manage multiple sites in one place. While UFM Consumer offers similar functionality to regular UFM, there are several behavioral differences related to aggregation.

10.2 Setting Up Multi-Subnet UFM

In `/opt/ufm/files/conf/gv.cfg`, fill in the section named `[Multisubnet]` for UFM Multi-Subnet Provider and Consumer.

To set up UFM as a Multi-Subnet Provider, perform the following:

- Set `multisubnet_enabled` to `true`
- Set `multisubnet_role` to `provider`
- Set `multisubnet_site_name` (optional, if not set, it will be randomly generated); e.g., `provider_1`
- Start UFM

To set up UFM as a Multi-Subnet Consumer, perform the following:

- Set `multisubnet_enabled` to `True`
- Set `multisubnet_role` to `consumer`
- Start UFM

It is important to note that UFM Multi-Subnet Consumer can be configured on a machine or VM without an established InfiniBand connectivity. Additionally, users may customize UFM Provider and Consumer using optional configuration parameters found in the `[Multisubnet]` section of `/opt/ufm/files/conf/gv.cfg`.

10.3 Functionality

1. Following the initial launch of the Consumer, the Dashboard view is devoid of data, and a message containing a hyperlink leading to the Provider Management section is displayed.

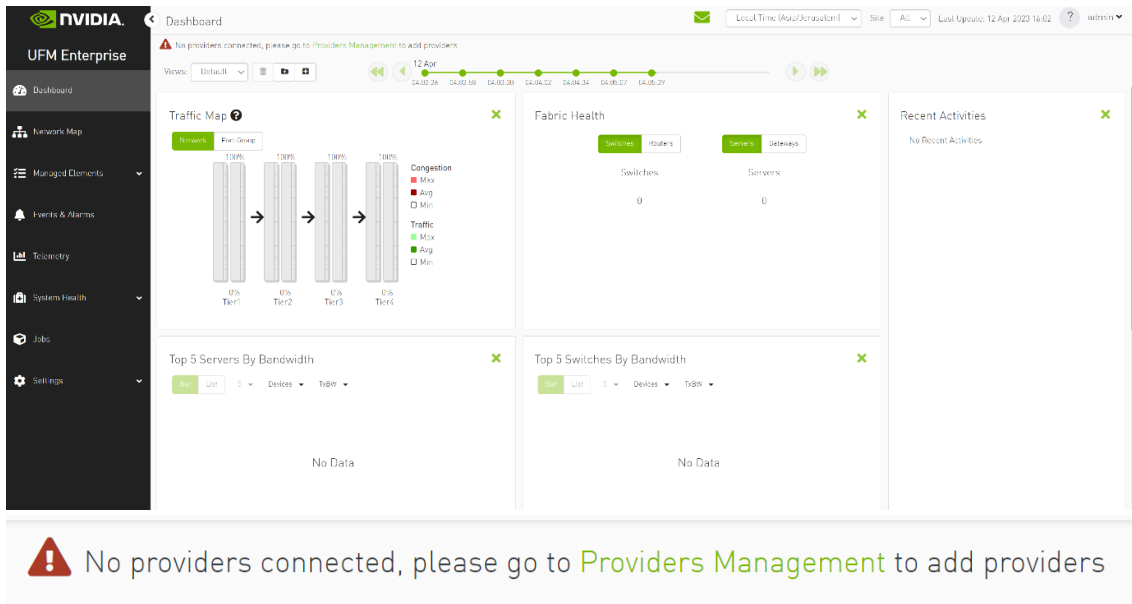

2. As shown in the below snapshot, a new section for Provider Management has been added, enabling users to configure UFM Providers.

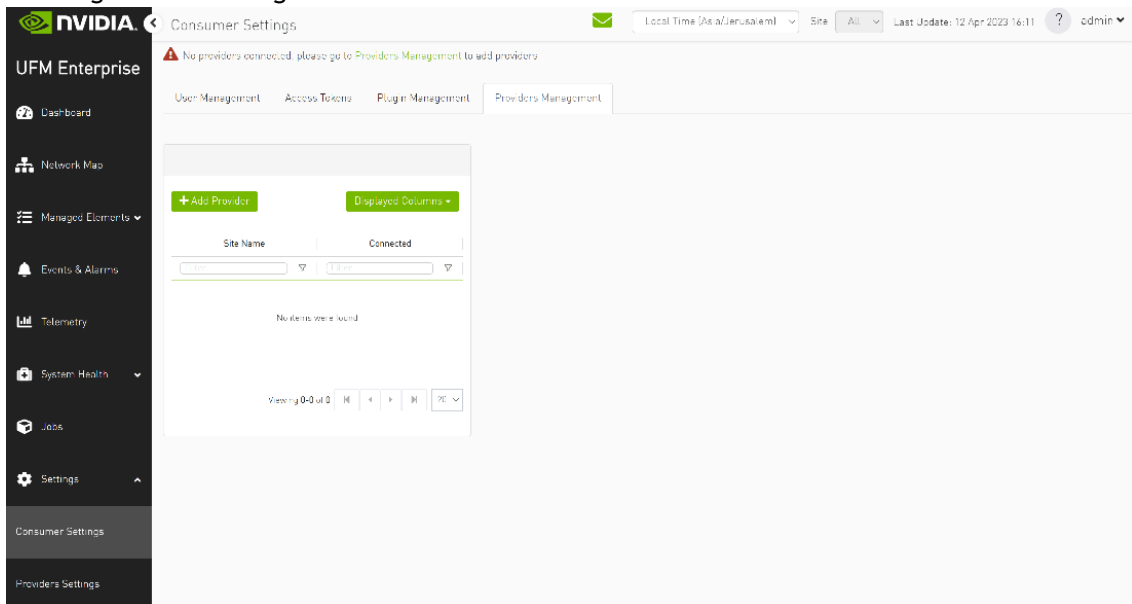

- a. To add a provider, the user is required to enter its IP address and credentials. Unless there are multiple instances of UFM providers on a single machine, the advanced section parameters should be set with default values. However, if there are multiple instances, the advanced parameters may be set per Provider and then be configured in the Providers Management view.

Add Provider
✕

General

Address

Credential

User Name

Password

Advanced

Topology Port

Proxy Port

Telemetry Port

b. By editing the Provider view, you can change Provider's credentials.

User Management
Access Tokens
Plugin Management
Providers Management

Site Name	Connected
provider_1000	✔

Viewing 1-1 of 1

provider_1000 - Information

General

Address

Credential

User Name

Password

Advanced

Topology Port

Proxy Port

Telemetry Port

c. The "Delete Provider" function removes the selected Provider from the Consumer. Please note that this action may take some time to complete, and changes may only be reflected in the view after approximately 30 seconds.

336

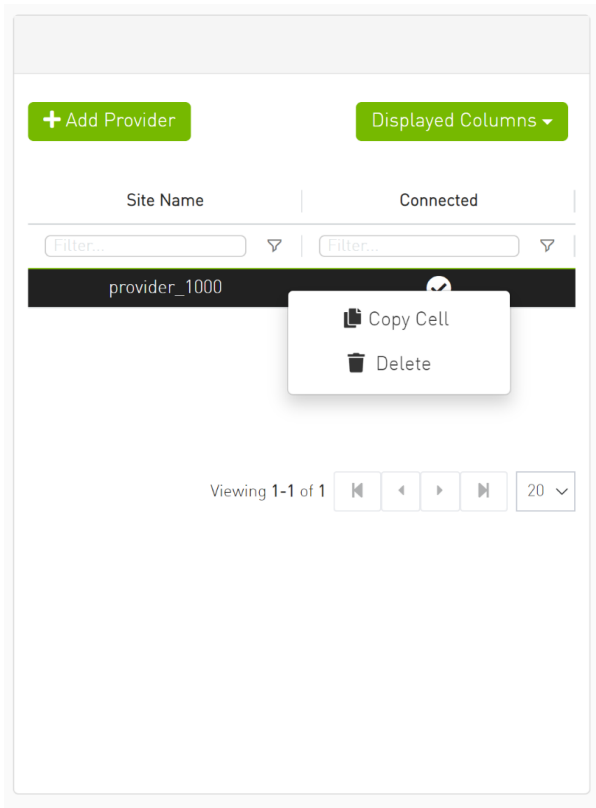

3. A general filter has been added to the top right corner of the page, enabling users to filter displayed data by site.

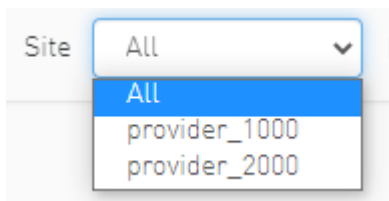
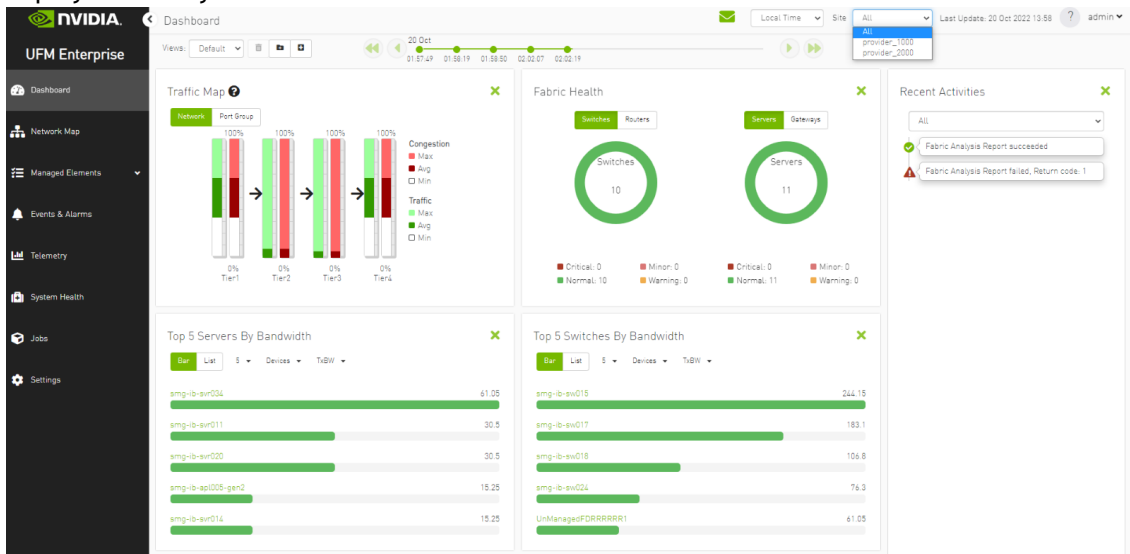

Devices Local Time (Asia/Jerusalem) Site: All Last Update: 12 Apr 2023 16:35 admin

Site dropdown menu: All, provider_2000, provider_1000

Filters: All Types, All Groups, Displayed Columns, CSV

Severity	Name	GUID	Type	Model	IP	Firmware Version	Site Name
Warn...	r-ufm83	0xec0d9a0300b52f4	host		0.0.0.0	16.33.1048	provider_2000
Info	sharp2	0x7cfe900300a5a2a0	switch	MS437800	0.0.0.0		provider_1000
Info	switchib	0xec0d9a030029aba0	switch	FDR	0.0.0.0		provider_1000
Info	ufm-host87	0xec0d9a03007d701a	host		0.0.0.0		provider_1000
Info	r-ufm254-hyp-04	0xd43f720300bd1d3c	host		0.0.0.0		provider_1000
Info	r-ufm254-hyp-03	0x0c47a103007aca90	host		0.0.0.0		provider_1000
Warn...	desc1	0xd43f720300706650	switch	FDR	0.0.0.0	15.2007.354	provider_2000
Info	node001	0xec0d9a0300c04b4	host		0.0.0.0	16.31.1046	provider_2000
Info	swx-tor01	0xec0d9a0300d469fc	host		0.0.0.0		provider_2000

Viewing 1-9 of 9

Devices Local Time (Asia/Jerusalem) Site: provider_2000 Last Update: 12 Apr 2023 16:35 admin

Filters: All Types, All Groups, Displayed Columns, CSV

Severity	Name	GUID	Type	Model	IP	Firmware Version	Site Name
Warn...	r-ufm83	0xec0d9a0300b52f4	host		0.0.0.0	16.33.1048	provider_2000
Warn...	desc1	0x043720300206650	switch	EDR	0.0.0.0	15.2007.354	provider_2000
Info	node001	0xec0d9a0300c04b4	host		0.0.0.0	16.31.1046	provider_2000
Info	swx-tor01	0xec0d9a0300d469fc	host		0.0.0.0		provider_2000

Viewing 1-4 of 4

4. Network map contains “clouds” for each provider.

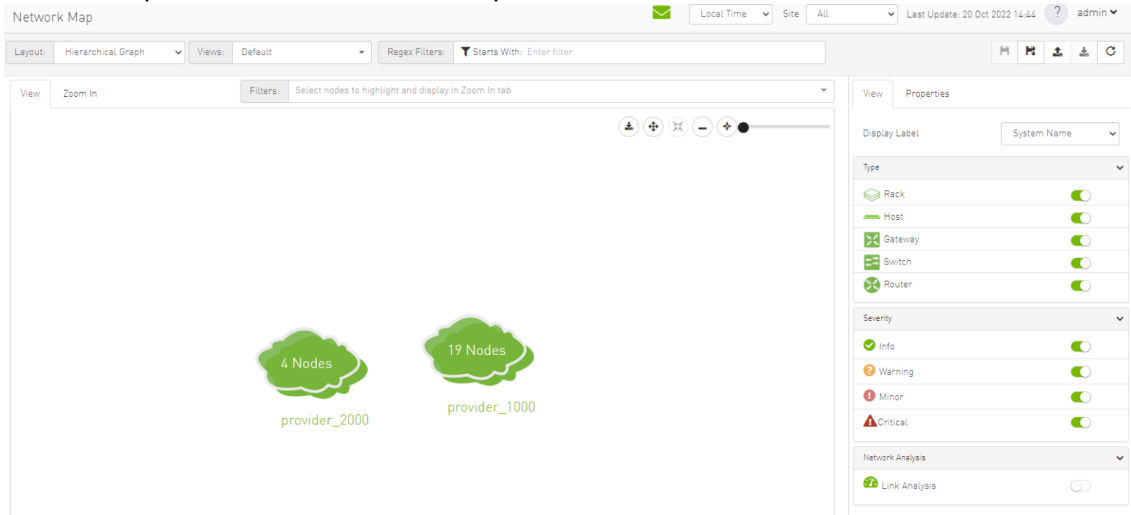

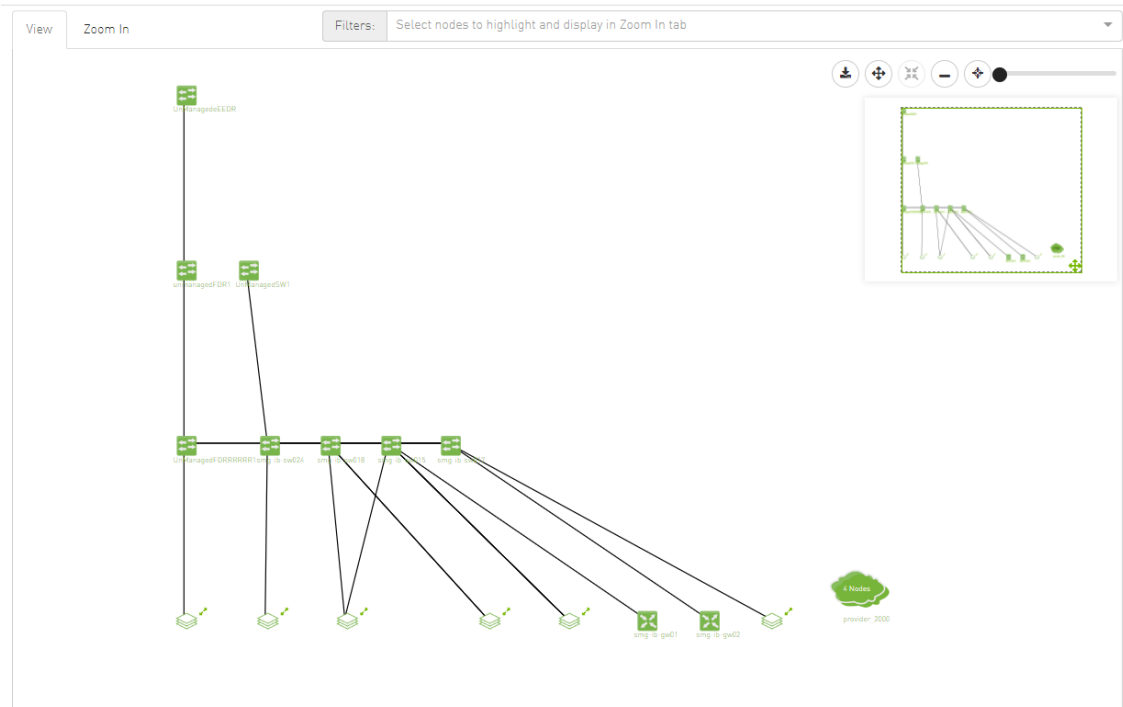

- A "Site Name" column is present in all Managed Elements sections. The column is disabled (hidden) by default.

Displayed Columns CS

- Restore Default
- Severity
- Name
- GUID
- Type
- Model
- IP
- Firmware Version
- Site Name

Devices Local Time (Asia/Jerusalem) Site All Last Update: 12 Apr 2023 16:56 admin

Severity	Name	GUID	Type	Model	IP
Info	r-ufm83	0xec0d9a0300b5274	host		0.0.0.0
Info	sharp2	0x7cfe90c300a5a2a0	switch	MSB7800	0.0.0.0
Info	switchib	0xec0d9a030029dba0	switch	LDIR	0.0.0.0
Info	ufm-host87	0xec0d9a03007d7f0a	host		0.0.0.0
Info	r-ufm254-hyp-04	0x043720300d1d3c	host		0.0.0.0
Info	r-ufm254-hyp-03	0xdc42a103009aca90	host		0.0.0.0
Info	desc1	0x043720300706650	switch	FDR	0.0.0.0
Info	node001	0xec0d9a0300c04b14	host		0.0.0.0
Info	swx-tor01	0xec0d9a0300469fc	host		0.0.0.0

Viewing 1-9 of 9

Devices Local Time (Asia/Jerusalem) Site All Last Update: 12 Apr 2023 16:56 admin

All Types All Groups Displayed Columns CSV

Severity	Name	GUID	Type	Model	IP	Site Name
Info	r-ufm83	0xec0d9a0300b6f52f4	host		0.0.0.0	provider_2000
Info	sharp2	0x7cfe900300a5a7a0	switch	MSB7800	0.0.0.0	provider_1000
Info	switchib	0xec0d9a030029dba0	switch	EDR	0.0.0.0	provider_1000
Info	ufm-host87	0xec0d9a03007d7f0a	host		0.0.0.0	provider_1000
Info	r-ufm254-hyp-04	0x043f720300dd1d3c	host		0.0.0.0	provider_1000
Info	r-ufm254-hyp-03	0x0c42a103007aca90	host		0.0.0.0	provider_1000
Info	desc1	0x043f720300206650	switch	EDR	0.0.0.0	provider_2000
Info	node001	0xec0d9a0300c04b44	host		0.0.0.0	provider_2000
Info	swx-tor01	0xec0d9a0300669ffc	host		0.0.0.0	provider_2000

Viewing 1-9 of 9

6. The "Group" and "Telemetry" sections include "Site" filters.

New Group

1 General 2 Members

Site: All (dropdown menu)

Type	Name	Site Name
switch	desc1	provider_2000
host	node001	provider_2000
host	r-ufm83	provider_2000
host	r-ufm254-hyp-03	provider_1000
host	r-ufm254-hyp-04	provider_1000
switch	sharp2	provider_1000
switch	switchib	provider_1000
host	swx-tor01	provider_2000

Viewing 1-8 of 9

Type	Name	Site Name
No items were found		

Viewing 0-0 of 0

Previous Finish

7. The filter in "Groups" impacts the Members table only.

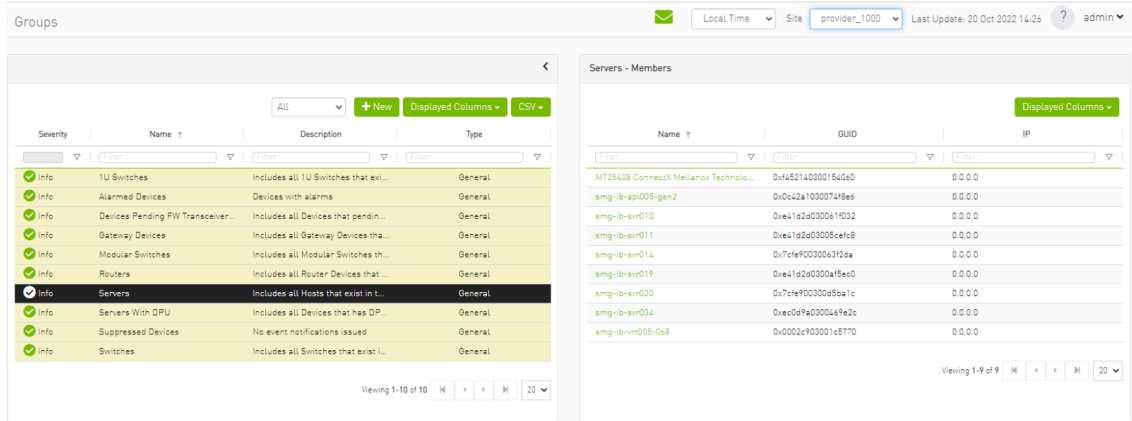
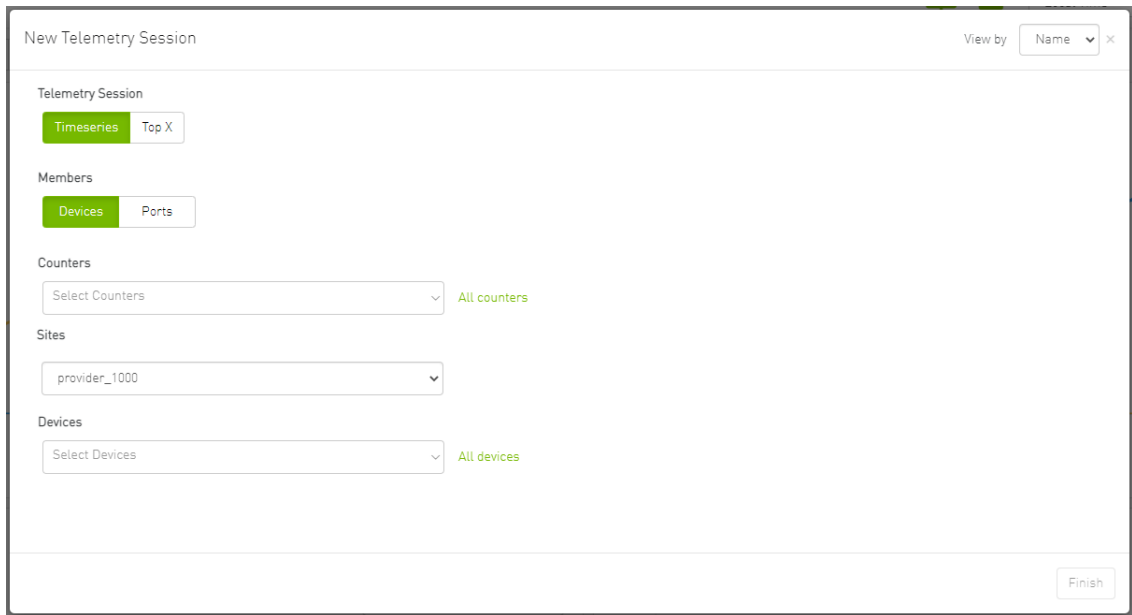

8. In the System Health tab, subsections for Consumer and Provider are available.
- Consumer System Health tab contains sections applicable to Consumer UFM specifically (e.g., logs from Consumer UFM).

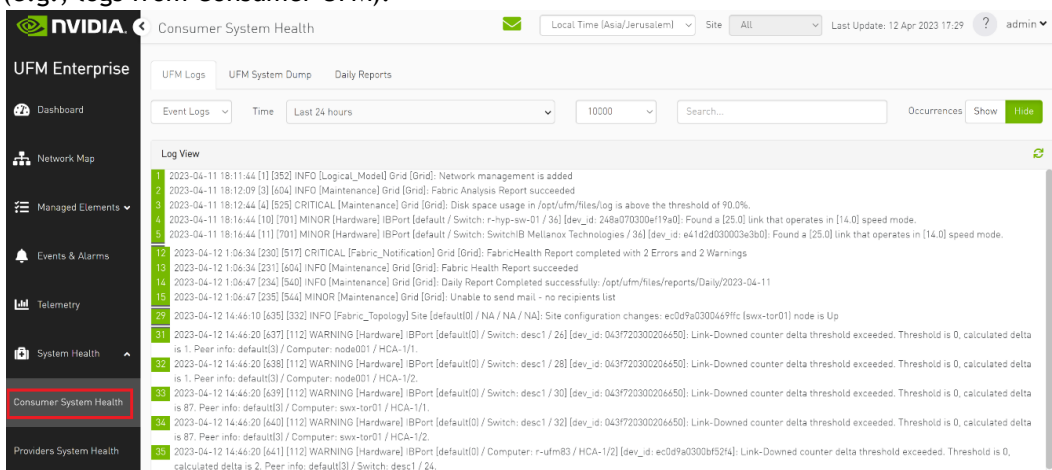

- Provider System Health contains sections applicable to one or multiple providers (e.g., Fabric Health Report can be triggered on multiple Providers from the Consumer).

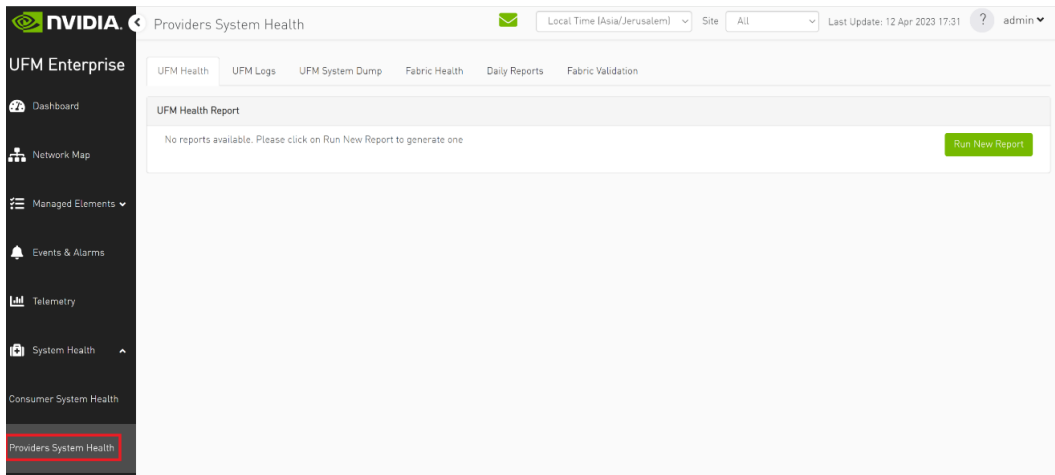

9. UFM Health tab contains sub report tables for each provider.

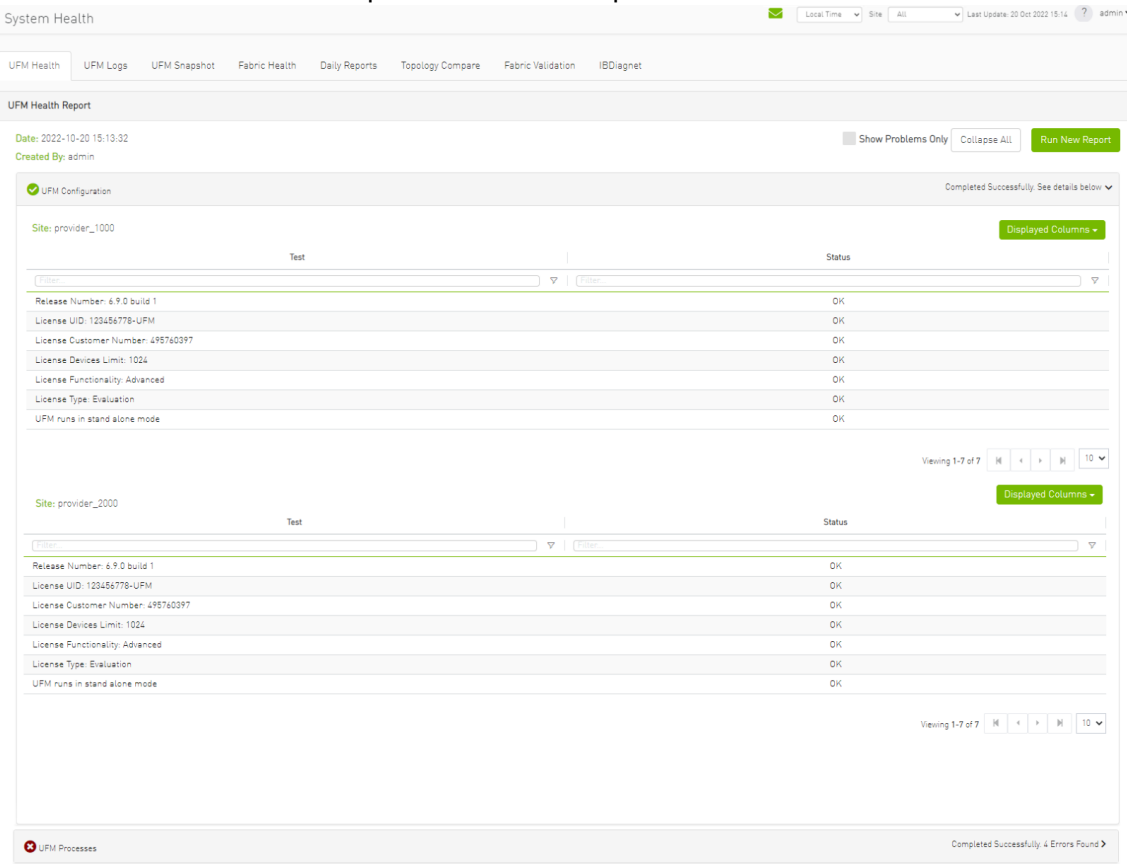

10. Fabric Health contains sub report tables for each provider.

System Health Local Time Site All Last Update: 20 Oct 2022 15:14 admin

UFM Health UFM Logs UFM Snapshot **Fabric Health** Daily Reports Topology Compare Fabric Validation IBDiagnet

Fabric Health Report

Date: 2022-10-20 14:49:44 Show Problems Only Collapse All Run New Report

Created By: admin

Report Summary

Site: provider_1000 Displayed Columns

Fabric Test	Warnings	Errors	Total
Non-unique and Zero LID Values	0	0	0
Non-unique Node Descriptions	2	0	2
SM Status	0	0	0
Bad Links	0	0	0
Link Width	0	0	0
Link Speed	0	6	6
Firmware Versions	2	0	2
UFM Alarms	0	1	1
BER Error and Warning check	0	0	0
Symbol BER Error and Warning check	0	0	0

Viewing 1-10 of 11

Site: provider_2000 Displayed Columns

Fabric Test	Warnings	Errors	Total
Non-unique and Zero LID Values	0	0	0
Non-unique Node Descriptions	2	0	2
SM Status	0	0	0
Bad Links	0	0	0
Link Width	0	0	0
Link Speed	0	6	6
Firmware Versions	2	0	2
UFM Alarms	198	2	200
BER Error and Warning check	0	0	0
Symbol BER Error and Warning check	0	0	0

Viewing 1-10 of 11

Fabric Summary

11. Daily Reports:

a. Consumer Daily reports display consumer reports.

Consumer System Health Local Time (Asia/Jerusalem) Site All

UFM Logs UFM System Dump **Daily Reports**

Recipients List Displayed Columns

Report ↓

Filter

2023-04-11

Viewing 1-1 of 1

b. Providers Daily reports display reports from all providers.

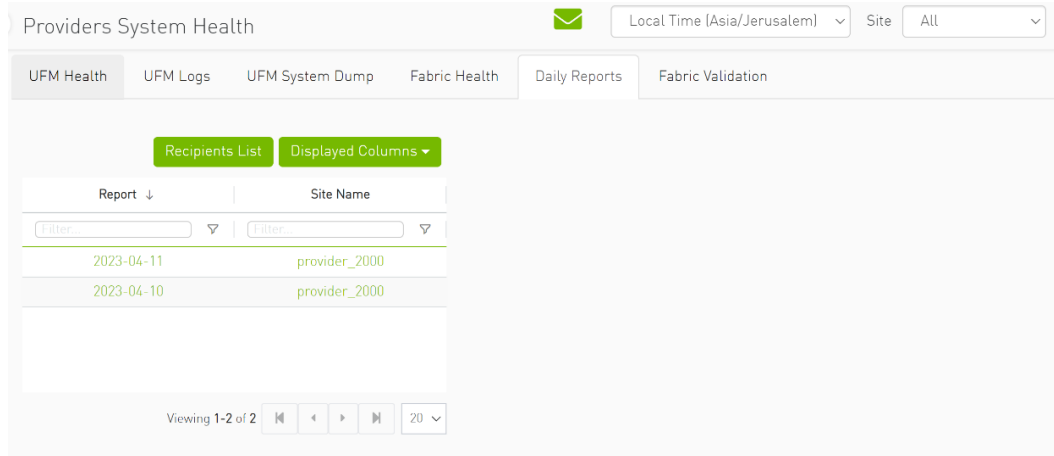

12. The "Fabric Validation" tab contains sub report tables for each provider.

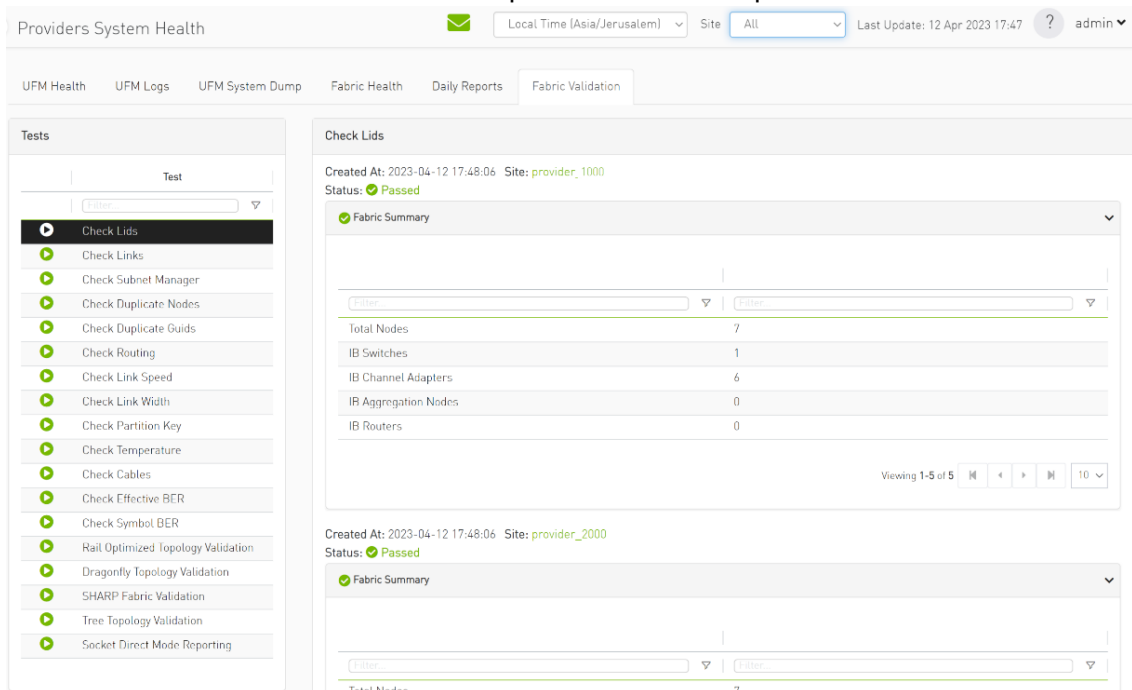

13. In "UFM Logs" Tab:

a. Consumer logs:

Consumer System Health

Local Time (Asia/Jerusalem) Site: All Last Update: 12 Apr 2023 18:01 admin

UFM Logs UFM System Dump Daily Reports

Event Logs Time Last 24 hours 10000 Search... Occurrences Show Hide

Log View

- 2023-04-11 18:11:44 [1] [352] INFO [Logical_Model] Grid [Grid]: Network management is added
- 2023-04-11 18:12:09 [3] [604] INFO [Maintenance] Grid [Grid]: Fabric Analysis Report succeeded
- 2023-04-11 18:12:44 [4] [525] CRITICAL [Maintenance] Grid [Grid]: Disk space usage in /opt/ufm/files/log is above the threshold of 90.0%.
- 2023-04-11 18:16:44 [10] [701] MINOR [Hardware] IBPort [default / Switch: r-hyp-sw-01 / 36] [dev_id: 248a070300e119a0]: Found a [25.0] link that operates in [14.0] speed mode.
- 2023-04-11 18:16:44 [11] [701] MINOR [Hardware] IBPort [default / Switch: SwitchB Mellanox Technologies / 36] [dev_id: e41d2d030003e3b0]: Found a [25.0] link that operates in [14.0] speed mode.
- 2023-04-12 1:06:34 [230] [517] CRITICAL [Fabric_Notification] Grid [Grid]: FabricHealth Report completed with 2 Errors and 2 Warnings
- 2023-04-12 1:06:34 [231] [604] INFO [Maintenance] Grid [Grid]: Fabric Health Report succeeded
- 2023-04-12 1:06:47 [234] [540] INFO [Maintenance] Grid [Grid]: Daily Report Completed successfully: /opt/ufm/files/reports/Daily/2023-04-11
- 2023-04-12 1:06:47 [235] [544] MINOR [Maintenance] Grid [Grid]: Unable to send mail - no recipients list
- 2023-04-12 14:46:10 [635] [332] INFO [Fabric_Topology] Site [default0] / NA / NA / NA: Site configuration changes: ec0d9a0300469ffc (swx-tor01) node is Up
- 2023-04-12 14:46:20 [637] [112] WARNING [Hardware] IBPort [default0] / Switch: desc1 / 26] [dev_id: 043f720300206650]: Link-Downed counter delta threshold exceeded. Threshold is 0, calculated delta is 1. Peer info: default03 / Computer: node001 / HCA-1/1.
- 2023-04-12 14:46:20 [638] [112] WARNING [Hardware] IBPort [default0] / Switch: desc1 / 28] [dev_id: 043f720300206650]: Link-Downed counter delta threshold exceeded. Threshold is 0, calculated delta is 1. Peer info: default03 / Computer: node001 / HCA-1/2.
- 2023-04-12 14:46:20 [639] [112] WARNING [Hardware] IBPort [default0] / Switch: desc1 / 30] [dev_id: 043f720300206650]: Link-Downed counter delta threshold exceeded. Threshold is 0, calculated delta is 87. Peer info: default03 / Computer: swx-tor01 / HCA-1/1.
- 2023-04-12 14:46:20 [640] [112] WARNING [Hardware] IBPort [default0] / Switch: desc1 / 32] [dev_id: 043f720300206650]: Link-Downed counter delta threshold exceeded. Threshold is 0, calculated delta is 87. Peer info: default03 / Computer: swx-tor01 / HCA-1/2.
- 2023-04-12 14:46:20 [641] [112] WARNING [Hardware] IBPort [default0] / Computer: r-ufm83 / HCA-1/2] [dev_id: ec0d9a0300b52f4]: Link-Downed counter delta threshold exceeded. Threshold is 0, calculated delta is 2. Peer info: default03 / Switch: desc1 / 24.
- 2023-04-12 14:28:20 [632] [332] INFO [Fabric_Topology] Site [default0] / NA / NA / NA: Site configuration changes: ec0d9a0300b52f4 (r-ufm83) node is Up
- 2023-04-12 16:29:10 [644] [525] CRITICAL [Maintenance] Grid [Grid]: Disk space usage in /opt/ufm/tmp is above the threshold of 80.0%.
- 2023-04-12 16:29:10 [645] [605] CRITICAL [Maintenance] Grid [Grid]: Fabric Analysis Report failed. Return code: 1
- 2023-04-12 16:31:40 [647] [112] WARNING [Hardware] IBPort [default0] / Computer: r-ufm83 / HCA-1/2] [dev_id: ec0d9a0300b52f4]: Link-Downed counter delta threshold exceeded. Threshold is 0, calculated delta is 2. Peer info: default03 / Switch: desc1 / 24.
- 2023-04-12 16:31:40 [648] [112] WARNING [Hardware] IBPort [default0] / Switch: desc1 / 26] [dev_id: 043f720300206650]: Link-Downed counter delta threshold exceeded. Threshold is 0, calculated delta

b. Providers logs display providers log separately, displaying logs for all providers is not supported.

Providers System Health

Local Time (Asia/Jerusalem) Site: provider_2000 Last Update: 12 Apr 2023 18:05 admin

UFM Health UFM Logs UFM System Dump Fabric Health Daily Reports Fabric Validation

Event Logs Time Last 24 hours 10000 Search... Occurrences Show Hide

Log View

- 2023-04-12 1:07:52 [53] [516] WARNING [Fabric_Notification] Grid [Grid]: FabricHealth Report completed with 4 Warnings
- 2023-04-12 1:07:52 [54] [604] INFO [Maintenance] Grid [Grid]: Fabric Health Report succeeded
- 2023-04-12 1:08:03 [56] [540] INFO [Maintenance] Grid [Grid]: Daily Report Completed successfully: /opt/ufm/files/reports/Daily/2023-04-11
- 2023-04-12 1:08:03 [56] [544] MINOR [Maintenance] Grid [Grid]: Unable to send mail - no recipients list
- 2023-04-12 2:34:20 [57] [65] WARNING [Fabric_Notification] IBPort [default03 / Computer: swx-tor01 / HCA-1/2] [dev_id: ec0d9a0300469ffc]: OID Address Out of Service: prefix fe800000000000000000000000000000 Link Source 043f720300206650_32 TO Dest: ec0d9a0300469ffc_2
- 2023-04-12 2:34:20 [58] [65] WARNING [Fabric_Notification] IBPort [default03 / Computer: swx-tor01 / HCA-1/1] [dev_id: ec0d9a0300469ffc]: OID Address Out of Service: prefix fe800000000000000000000000000000 Link Source 043f720300206650_30 TO Dest: ec0d9a0300469ffc_1
- 2023-04-12 2:34:20 [59] [329] WARNING [Fabric_Topology] Link [Source 043f720300206650_30 TO Dest: ec0d9a0300469ffc_1]: Link went down: [Switch:desc1-30]043f720300206650-30 - [Computer:swx-tor01 mx5_0]ec0d9a0300469ffc:1, cable S/N: MT2042V506276
- 2023-04-12 2:34:20 [60] [329] WARNING [Fabric_Topology] Link [Source 043f720300206650_32 TO Dest: ec0d9a0300469ffc_2]: Link went down: [Switch:desc1-32]043f720300206650-32 - [Computer:swx-tor01 mx5_1]ec0d9a0300469ffc:2, cable S/N: MT2042V506200
- 2023-04-12 2:34:20 [61] [331] WARNING [Fabric_Topology] Site [default0] / NA / NA / NA: Site configuration changes: ec0d9a0300469ffc (swx-tor01) node is Down
- 2023-04-12 2:36:45 [63] [64] INFO [Fabric_Notification] Site [default0] / NA / NA / NA: OID Address In Service: prefix fe800000000000000000000000000000 Link ec0d9a0300469ffc
- 2023-04-12 2:36:50 [65] [332] INFO [Fabric_Topology] Site [default0] / NA / NA / NA: Site configuration changes: ec0d9a0300469ffc (swx-tor01) node is Up
- 2023-04-12 2:36:50 [66] [328] INFO [Fabric_Topology] Link [Source 043f720300206650_30 TO Dest: ec0d9a0300469ffc_1]: Link is up: [Switch:desc1-30]043f720300206650-30 - [Computer:swx-tor01 mx5_0]ec0d9a0300469ffc:1
- 2023-04-12 2:36:50 [67] [328] INFO [Fabric_Topology] Link [Source 043f720300206650_32 TO Dest: ec0d9a0300469ffc_2]: Link is up: [Switch:desc1-32]043f720300206650-32 - [Computer:swx-tor01 mx5_1]ec0d9a0300469ffc:2
- 2023-04-12 2:36:58 [68] [1500] INFO [Security] Link [Source 043f720300206650_30 TO Dest: ec0d9a0300469ffc_1]: New cable S/N: MT2042V506276 is detected
- 2023-04-12 2:36:58 [69] [1500] INFO [Security] Link [Source 043f720300206650_32 TO Dest: ec0d9a0300469ffc_2]: New cable S/N: MT2042V506200 is detected
- 2023-04-12 2:36:58 [70] [604] INFO [Maintenance] Grid [Grid]: Fabric Analysis Report succeeded
- 2023-04-12 7:38:24 [82] [702] WARNING [Hardware] IBPort [default03 / Switch: desc1 / 30] [dev_id: 043f720300206650]: Peer Port swx-tor01 mx5_0 is considered by SM as unhealthy due to FLAPPING.
- 2023-04-12 7:38:24 [83] [702] WARNING [Hardware] IBPort [default03 / Computer: swx-tor01 / HCA-1/1] [dev_id: ec0d9a0300469ffc]: Peer Port desc1-30 is considered by SM as unhealthy due to FLAPPING.

14. In the "System Dump" tab:

a. "Consumer System Dump" collects system dump for consumer

Providers System Health

Local Time (Asia/Jerusalem) Site: provider_1000 Last Update: 12 Apr 2023 02:40 admin

UFM Health UFM Logs UFM System Dump Fabric Health Daily Reports Fabric Validation

Create System Dump

Create System Dump of UFM Database and Configuration Files.

Include Troubleshooting Information Create System Dump

The last system dump /opt/ufm/backup/ufm-host86_2023-04-13_01-40-49.tar.gz was created successfully. [Click here to download it.](#)

- b. "Providers System Dump" collect system dumps for one or all providers and mergeS them into one folder

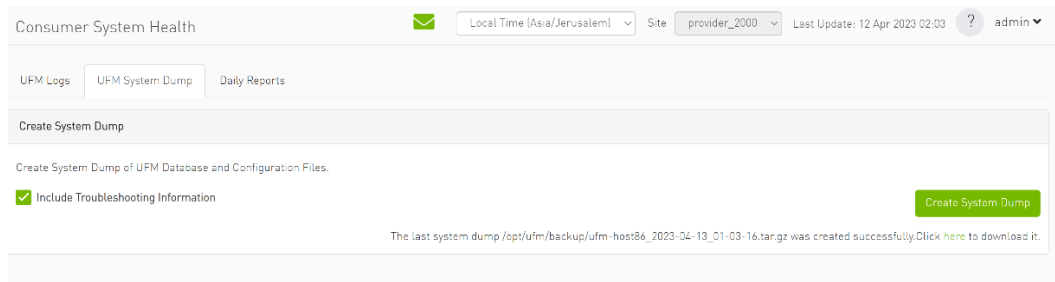

- 15. Under "Settings", subsections for Consumer and Provider are available.
 - a. "Consumer Settings" contain sections applicable to Consumer UFM specifically (e.g., creation of access tokens for UFM consumer authentication);

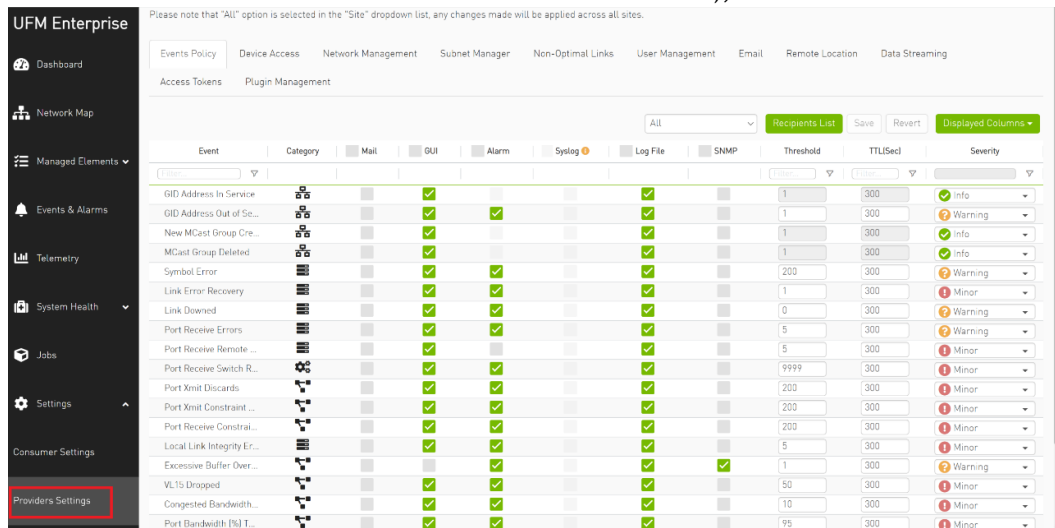

- b. "Provider Settings" contain sections applicable to one or multiple providers (e.g., Event Policies can be changed for multiple Providers at once from the Consumer).

UFM Enterprise

- Dashboard
- Network Map
- Managed Elements
- Events & Alarms
- Telemetry
- System Health
- Jobs
- Settings
- Consumer Settings**
- Providers Settings

User Management | Access Tokens | Plugin Management | Providers Management

[+ New](#) [Displayed Columns](#)

ID ↓	Name	Group
1	admin	System Admin

Viewing 1-1 of 1 ⏪ ⏩ 10

11 UFM Plugins

11.1 UFM Plugins Management

UFM plugin management can be done either via the `manage_ufm_plugins.sh` script or via the Web UI.

11.1.1 UFM Plugin Management Using the `manage_ufm_plugins.sh` Script

The `manage_ufm_plugins.sh` script, located in the `/opt/ufm/scripts` directory, is designed to manage UFM plugins through the command line interface.

To see the actions supported by this script, run:

```
/manage_ufm_plugins.sh --help
usage: manage_ufm_plugins.sh <command> [<args>]
positional arguments:
  {show,get-all,enable,start,stop,disable,add,upgrade,remove_image,remove,is-running,is-enable,get-http-proxy-
  port,debug,deploy,deploy-bundle}
  Commands
  show          Show plugins info
  get-all      get all loaded plugins
  enable       Enable plugin
  start        Start plugins
  stop         Stop all plugins
  disable      Disable plugin
  add          Add plugin
  upgrade      Upgrade plugin
  remove_image Remove plugin's image
  remove       Remove plugin
  is-running   Test plugin is running
  is-enable    Test plugin is enabled
  get-http-proxy-port Get plugin HTTP proxy port
  debug        Debug
  deploy       Deploy plugin image
  deploy-bundle Deploy bundle of plugins
```

Optional Arguments:

```
-h, --help          show this help message and exit
-v, --version       Print version information
```

Each supported option has its own help flag, which can be received by requesting help for a specific parameter. For example:

```
./manage_ufm_plugins.sh add --help
```

Usage:

```
manage_ufm_plugins.pyc <command> [<args>] add [-h] -p <[A-Za-z0-9_-] Name size: 32> [-t <[A-Za-z0-9._-] Name size: 128>]
```

Optional Arguments:

```
-h, --help          show this help message and exit
-p <[A-Za-z0-9_-] Name size: 32>, --plugin-name <[A-Za-z0-9_-] Name size: 32>          Plugin name
-t <[A-Za-z0-9._-] Name size: 128>, --plugin-tag <[A-Za-z0-9._-] Name size: 128>      Plugin tag
```

The following table lists the supported commands and provides their description and information on the parameters.

Command	Description	Parameters
<code>show</code>	Shows information about running plugins	N/A
<code>get-all</code>	Gets information about deployed plugins in JSON format	N/A
<code>enable</code>	Enables plugin	Loaded Parameter: plugin image name
<code>start</code>	Starts UFM plugin	Loaded Parameter: plugin name
<code>stop</code>	Stops UFM plugin	Loaded Parameter: plugin name
<code>disable</code>	Disables UFM plugin	Loaded Parameter: plugin name
<code>add</code>	Adds UFM plugin	Loaded Parameter: image name
<code>upgrade</code>	Upgrades UFM plugin	Loaded Parameter: plugin name
<code>remove_image</code>	Removes UFM plugin's image	Loaded Parameter: plugin image name
<code>remove</code>	Removes UFM plugin	Loaded Parameter: plugin name
<code>is-running</code>	Tests plugin is running	Loaded Parameter: plugin name
<code>is-enable</code>	Tests plugin is enabled	Loaded Parameter: plugin name
<code>get-http-proxy-port</code>	Gets plugin HTTP proxy port	Loaded Parameter: plugin name
<code>deploy</code>	Deploys plugin image	Loaded Parameter: - <code>f</code> flag with path to UFM plugin image
<code>deploy-bundle</code>	Deploys bundle of plugins	Loaded Parameter: - <code>f</code> flag with path to tarball file, that will contain number of UFM plugins. All the plugin images from the tar ball will be deployed to UFM. Operation could take some time. The progress of the plugin images from the tar file deployment will be printed to terminal, including error messages, if exists.

11.2 UFM Plugins

- [Plugins Bundle](#)
- [REST-RDMA Plugin](#)
- [NDT Plugin](#)
- [UFM Telemetry Fluentd Streaming \(TFS\) Plugin](#)
- [UFM Events Fluent Streaming \(EFS\) Plugin](#)
- [UFM Bright Cluster Integration Plugin](#)
- [UFM Cyber-AI Plugin](#)
- [Autonomous Link Maintenance \(ALM\) Plugin](#)
- [ClusterMinder Plugin](#)
- [GRPC-Streamer Plugin](#)
- [Sysinfo Plugin](#)

- [SNMP Plugin](#)
- [Packet Level Monitoring Collector \(PMC\) Plugin](#)
- [PDR Deterministic Plugin](#)
- [GNMI-Telemetry Plugin](#)
- [UFM Telemetry Manager \(UTM\) Plugin](#)
- [UFM Consumer Plugin](#)
- [Fast-API Plugin](#)
- [UFM Light Plugin](#)
- [Key Performance Indexes \(KPI\) Plugin](#)

11.3 Plugins Bundle

The default plugin bundle contains the NDT, TFS, KPI, PMC, and Cluster Minders plugins, packaged in a tarball file. To download this bundle, refer to [NVIDIA's Licensing Portal](#).

To deploy the plugin bundle within the UFM ecosystem, follow these steps:

For a UFM Bare Metal Deployment:

1. Download the bundle from NVIDIA's Licensing Portal.
2. Run the following command:

```
/opt/ufm/scripts/manage_ufm_plugins.sh deploy-bundle -f <plugins bundle file name>
```

For Docker Container-based UFM Deployment:

1. Download the bundle from NVIDIA's Licensing Portal and move the file to the `/opt/ufm/ufm_plugins_data` directory.
2. Run the following command:

```
docker exec ufm /opt/ufm/scripts/manage_ufm_plugins.sh deploy-bundle -f /opt/ufm/ufm_plugins_data/<plugins bundle file name>
```

All plugin images from the tarball will be deployed to UFM. The process may take some time, and progress, including any error messages, will be displayed in the terminal.

11.4 REST-RDMA Plugin

The REST-RDMA is a tool designed for sending requests over InfiniBand to the UFM server. These REST requests can fall into three categories:

1. UFM REST API requests
2. ibdiagnet requests
3. Telemetry requests

The rest-rdma utility is distributed as a Docker container, capable of functioning both as a server and a client.

11.4.1 Deployment Server

11.4.1.1 Deploy Plugin on UFM Appliance

1. Log into your UFM as admin.
2. Enter config mode. Run:

```
enable
config terminal
```

Make sure that UFM is running with `show ufm status`. If UFM is down, then run with `ufm start`.

3. Ensure that rest-rdma plugin is disabled with the `show ufm plugin` command.
4. Pull the plugin container with `docker pull mellanox/ufm-plugin-rest-rdma:[version]`.
5. Run `ufm plugin rest-rdma add tag [version]` to enable the plugin.
6. Check that plugin is up and running with `docker pull mellanox/ufm-plugin-rest-rdma:[version]`

11.4.1.2 Deploy Plugin on Bare Metal Server

1. Verify that UFM is installed and running.
2. Pull image from docker hub:

```
docker pull mellanox/ufm-plugin-rest-rdma:[version]
```
3. To load image run:

```
/opt/ufm/scripts/manage_ufm_plugins.py add -p rest-rdma
```

Example with credentials:

11.4.1.3 Deployment Client

Run the following command to pull the image from the docker hub:

```
docker pull mellanox/ufm-plugin-rest-rdma:[version]
```

Verify that the `/tmp/ibdiagnet` directory exists on the client's computer. If not - create it.

To start container as client (on any host in the same fabric as UFM server) run:

```
docker run -d --network=host --privileged --name=ufm-plugin-rest-rdma --rm -v /tmp/ibdiagnet:/tmp/ibdiagnet
mellanox/ufm-plugin-rest-rdma:[version] client
```

To check that plugin is up and running, run:

```
docker ps
```

11.4.2 How to Run

11.4.2.1 Server

In server mode `ufm_rdma.py` is started automatically and is restarted if exited. If the `ufm_rdma.py` server is not running - enter to the docker and run the following commands to start the server:

```
cd /opt/ufm/src/ufm-plugin-ufm-rest
./ufm_rdma.py -r server
```

11.4.2.2 Client

There are three options to run client. Running the client from inside the Docker container, using a custom script from the hosting server to execute the client or using the "docker exec" command from the hosting server.

1. Option 1: Run the client from inside the Docker container
 - a. Enter the docker container using `docker exec -it ufm-plugin-rest-rdma bash`
 - b. Then, run `cd /opt/ufm/src/ufm-plugin-rest-rdma`
 - c. Use the `-h` help option to see the available parameters

```
./ufm_rdma.py -h
```

2. Option 2: From the host server, the scripts can be located at `/opt/ufm/ufm-plugin-ufm-rest/` directory inside the docker container. They can copied using the following command:

```
cp <containerId>:/opt/ufm/ufm-plugin-ufm-rest/[script name] /host/path/target
```

Example:

```
cp <containerId>:/opt/ufm/ufm-plugin-ufm-rest/ufm-rest-rdma_client.sh /host/path/target
```

- a. To see the available options, run:

```
./ufm-rest-rdma_client.sh -h
```

3. Option 3: From hosting server, use the `docker exec` command.

To run from inside docker, run:

```
docker exec ufm-plugin-rest-rdma prior to the command.
```

For example: `docker exec ufm-plugin-rest-rdma /opt/ufm/ufm-plugin-ufm-rest/src/ufm_rdma.py -r client -u admin -p password -t simple -a GET -w ufmRest/app/ufm_version`

11.4.3 Authentication Configuration

Telemetry and ibdiagnet request authentication options could be enabled or disabled (enabled by default - set to True) in `ufm_rdma.ini` file in [Server] section on the server. The `rest_rdma` server performs simple requests to UFM server, using supplied credentials to verify that the user is allowed to run telemetry or ibdiagnet requests.

```
[Server]
use_ufm_authentication=True
```

11.4.3.1 Remote ibdiagnet Request

The following two user scripts can run on the hosting server.

- `remote_ibdiagnet_auth.sh`
- `remote_ibdiagnet.sh`

These scripts should be copied from the container to the hosting server using the following command:

```
cp <containerId>:/opt/ufm/ufm-plugin-ufm-rest/[script name] /host/path/target
```

Example :

```
cp <containerId>:/opt/ufm/ufm-plugin-ufm-rest/remote_ibdiagnet_auth.sh /host/path/target
```

The `remote_ibdiagnet.sh` script does not require authentication as the server side can run on a machine which does not run UFM (which is responsible for the authentication). This means it can run from the hosting server.

```
/remote_ibdiagnet.sh [options]
```

11.4.3.2 Authenticated Remote ibdiagnet Request

The `remote_ibdiagnet_auth.sh` script can receive parameters as credentials for authentication with UFM server.

```
/remote_ibdiagnet_auth.sh [options]
```

To get all the options, run the following command:

```
/remote_ibdiagnet_auth.sh -h
```

Important Note:

When using `remote_ibdiagnet.sh`, authentication is not required and the the `ibdiagnet` parameters should be sent in `ibdiagnet` format.

Example: `./remote_ibdiagnet.sh --get_phy_info`

When using the `remote_ibdiagnet_auth.sh`, the `ibdiagnet` parameters should be sent using the `-l` key.

Examples without credentials:

- `./remote_ibdiagnet_auth.sh -l '--get_phy_info'`
- `./remote_ibdiagnet_auth.sh -u username -p password`
- `./remote_ibdiagnet_auth.sh -u username -p password -l '--get_phy_info'`
- `./remote_ibdiagnet_auth.sh -k [token string] -l '--get_phy_info'`
- `./remote_ibdiagnet_auth.sh -s [defined for client certificate host name] -d [path to client certificate pfx file] -l '--get_phy_info'`

Please use the `-h` option to see the examples of credential usage.

11.4.3.3 Rest Request with Username/Password Authentication

To get the UFM version from inside the docker:

```
./ufm_rdma.py -r client -u admin -p admin_pwd -t simple -a GET -w ufmRest/app/ufm_version
```

To get the UFM version from hosting server using script:

```
./ufm_rest_rdma_client.sh -u admin -p admin_pwd -t simple -a GET -w ufmRest/app/ufm_version
```

For telemetry:

```
./ufm_rdma.py -r client -u admin -p admin_pwd -t telemetry -a GET -g 9001 -w /csv/enterprise
```

To get `ibdiagnet` run result using UFM REST API from inside the docker:

```
./ufm_rdma.py -r client -u admin -p admin_pwd -t ibdiagnet -a POST -w ufmRest/reports/ibdiagnetPeriodic -l '{"general": {"name": "IBDiagnet_CMD_1234567890_199_88", "location": "local", "running_mode": "once"}, "command_flags": {"-pc": ""}}'
```

11.4.3.4 Rest Request with Client Certificate Authentication

```
need to pass path to client certificate file and name of UFM server machine:  
6. ./ufm_rdma.py -r client -t simple -a GET -w ufmRest/resources/modules -d /path/to/certificate/file/ufm-client.pfx -s ufm.azurehpc.core.azure-test.net  
for telemetry if need authentication from inside the docker  
./ufm_rdma.py -r client -t telemetry -a GET -g 9001 -w csv/enterprise -d /path/to/certificate/file/ufm-client.pfx -s ufm.azurehpc.core.azure-test.net
```

Client certificate file should be located **INSIDE** the docker container.

11.4.3.5 Rest Request with Token Authentication

```
need to pass token for authentication
./ufm_rdma.py -r client -k OGUY7TwLyTmFkXyTksEWD9KKNvq6f -t simple -a GET -w ufmRestV3/app/ufm_version
for telemetry if need to perform authentication
./ufm_rdma.py -r client -k 4rQRf7i7wEeliuJEurGbeecc210V6G -t telemetry -a GET -g 9001 -w /csv/enterprise
```

Token could be generated using UFM UI.

If a token is used for client authentication, `ufmRestV3` must be used.

11.5 NDT Plugin

11.5.1 Overview

NDT plugin is a self-contained Docker container with REST API support managed by UFM. The NDT plugin introduces the following capabilities:

- a. NDT topology comparison: Allows the user to compare InfiniBand fabric managed by the UFM and NDT files which are used for the description of InfiniBand clusters network topology.
 - Verifies the IB fabric connectivity during cluster bring-up.
 - Verifies the specific parts of IB fabric after component replacements.
 - Automatically detects any changes in topology.
- b. Subnet Merger - Expansion of the fabric based on NDT topology files
Allows users to gradually extend the InfiniBand fabric without causing any disruption to the running fabric. The system administrator should prepare the NDT topology files, which describe the InfiniBand fabric extensions. Then, an intuitive and user-friendly UI wizard facilitates the topology extension process with a step-by-step guidance for performing necessary actions.
 - The Subnet Merger tool verifies the fabric topology within a predefined NDT file, and reports issues encountered for immediate resolution.
 - Once the verification results are acceptable by the network administrator, the tool creates a topoconfig file to serve as input for OpenSM. This allows setting the physical port states of the designated boundary ports as desired (physical ports can be set as disabled or no-discover).
 - Once the topoconfig file is deployed, the IB network can be extended and verified for the next IB extension.

11.5.2 Deployment

The following are the possible ways NDT plugin can be deployed:

1. On UFM Appliance
2. On UFM Software

For detailed instructions on how to deploy the NDT plugin refer to this [page](#).

11.5.3 Authentication

Following authentication types are supported:

- basic (/ufmRest)
- client (/ufmRestV2)
- token (/ufmRestV3)

11.5.4 REST API

The following REST APIs are supported:

11.5.4.1 Topodiff

- GET /help
- GET /version
- POST /upload_metadata
- GET /list
- POST /compare
- POST /cancel
- GET /reports
- GET /reports/<report_id>
- POST /delete

11.5.4.2 Subnet Merger

- GET /merger_ndts_list
- GET /merger_ndts_list/<ndt_file_name>
- POST /merger_upload_ndt
- POST /merger_verify_ndt
- GET /merger_verify_ndt_reports
- GET /merger_verify_ndt_reports/<report_id>
- POST /merger_update_topoconfig
- POST /merger_deploy_ndt_config
- POST /merger_update_deploy_ndt_config
- POST /merger_delete_ndt
- GET /merger_deployed_ndt
- POST /merger_create_topoconfig

For detailed information on how to interact with NDT plugin, refer to the [NVIDIA UFM Enterprise > Rest API > NDT Plugin REST API](#).

11.5.5 NDT Format - Topodiff

NDT is a CSV file containing data relevant to the IB fabric connectivity. The NDT plugin extracts the IB connectivity data based on the following fields:

1. Start device
2. Start port
3. End device
4. End port
5. Link type

11.5.5.1 Switch to Switch NDT

By default, IB links are filtered by:

- Link Type is Data
- Start Device and End Device end with IBn, where n is a numeric value.

For TOR switches, Start port/End port field should be in the format Port N, where N is a numeric value.

For Director switches, Start port/End port should be in the format Blade N_Port i/j, where N is a leaf number, i is an internal ASIC number and j is a port number.

Examples:

Start Device	Start Port	End Device	End Port	Link Type
DSM07-0101-0702-01IB0	Port 21	DSM07-0101-0702-01IB1	Blade 2_Port 1/1	Data
DSM07-0101-0702-01IB0	Port 22	DSM07-0101-0702-01IB1	Blade 2_Port 1/1	Data
DSM07-0101-0702-01IB0	Port 23	DSM07-0101-0702-02IB1	Blade 3_Port 1/1	Data
DSM09-0101-0617-001IB2	Port 33	DSM09-0101-0721-001IB4	Port 1	Data
DSM09-0101-0617-001IB2	Port 34	DSM09-0101-0721-001IB4	Port 2	Data
DSM09-0101-0617-001IB2	Port 35	DSM09-0101-0721-001IB4	Port 3	Data

11.5.5.2 Switch to Host NDT

NDT is a CSV file containing data not only relevant to the IB connectivity.

Extracting the IB connectivity data is based on the following five fields:

1. Start device
2. Start port
3. End device
4. End port
5. Link type

IB links should be filtered by the following:

- Link type is "Data".
- "Start Device" or "End Device" end with IBN, where N is a numeric value.
 - The other Port should be based on persistent naming convention: ibpXsYfZ, where X, Y and Z are numeric values.

For TOR switches, Start port/End port field will be in the format Port n, where n is a numeric value.

For Director switches, Start port/End port will be in the format Blade N_Port i/j, where N is a leaf number, i is an internal ASIC number and j is a port number.

Examples:

Start Device	Start Port	End Device	End Port	Link Type
DSM071081704019	DSM071081704019 ibp11s0f0	DSM07-0101-0514-01IB0	Port 1	Data
DSM071081704019	DSM071081704019 ibp21s0f0	DSM07-0101-0514-01IB0	Port 2	Data
DSM071081704019	DSM071081704019 ibp75s0f0	DSM07-0101-0514-01IB0	Port 3	Data

11.5.5.3 Other

Comparison results are forwarded to syslog as events. Example of `/var/log/messages` content:

1. Dec 9 12:32:31 <server_ip> ad158f423225[4585]: NDT: missing in UFM "SAT111090310019/ SAT111090310019 ibp203s0f0 - SAT11-0101-0903-19IB0/15"
2. Dec 9 12:32:31 <server_ip> ad158f423225[4585]: NDT: missing in UFM "SAT11-0101-0903-09IB0/27 - SAT11-0101-0905-01IB1-A/Blade 12_Port 1/9"
3. Dec 9 12:32:31 <server_ip> ad158f423225[4585]: NDT: missing in UFM "SAT11-0101-0901-13IB0/23 - SAT11-0101-0903-01IB1-A/Blade 08_Port 2/13"

For detailed information about how to check syslog, please refer to the [NVIDIA UFM-SDN Appliance Command Reference Guide](#) > UFM Commands > UFM Logs.

Minimal interval value for periodic comparison in five minutes.

In case of an error the clarification will be provided.

For example, the request “`POST /compare`” without NDTs uploaded will return the following:

- URL: https://<server_ip>/ufmRest/plugin/ndt/compare
- response code: 400
- Response:

```
{
  "error": [
    "No NDTs were uploaded for comparison"
  ]
}
```

Configurations could be found in “`ufm/conf/ndt.conf`”

- Log level (default: INFO)
- Log size (default: 10240000)
- Log file backup count (default: 5)
- Reports number to save (default: 10)
- NDT format check (default: enabled)
- Switch to switch and host to switch patterns (default: see NDT format section)

For detailed information on how to export or import the configuration, refer to the [NVIDIA UFM-SDN Appliance Command Reference Guide](#) > UFM Commands > UFM Configuration Management.

Logs could be found in “`ufm/logs/ndt.log`”.

For detailed information on how to generate a debug dump, refer to the [NVIDIA UFM-SDN Appliance Command Reference Guide](#) > System Management > Configuration Management > File System.

11.5.6 NDT Format - Subnet Merger

The Subnet Merger tool facilitates the seamless expansion of the InfiniBand fabric based on Non-Disruptive Topology (NDT) files. This section outlines the process of extending the fabric while ensuring uninterrupted operation. The tool operates through an intuitive UI wizard, guiding users step-by-step in extending the fabric topology.

The Subnet Merger tool enables the gradual expansion of the InfiniBand fabric without causing disruptions to the existing network. To achieve this, system administrators need to prepare NDT topology files that describe the planned fabric extensions. The tool offers an intuitive UI wizard that simplifies the extension process.

11.5.6.1 Functionality

1. **NDT Topology File Verification:** The Subnet Merger tool verifies the InfiniBand fabric topology specified in a predefined NDT file. During this verification, any issues encountered are reported to the user for immediate resolution. This step ensures the integrity of the planned fabric extension.
1. **Topology Extension Preparation:** Upon successful verification of the NDT topology file, the tool generates a comprehensive verification report. The network administrator reviews this report and ensures its acceptability.
1. **Topoconfig File Generation:** After obtaining acceptable verification results, the tool generates a topoconfig file. This file serves as input for OpenSM, the Subnet Manager for InfiniBand fabrics. The topoconfig file allows the network administrator to define the desired physical port states for designated boundary ports. These states include "disabled" or "no-discover."
1. **Fabric Extension and Verification:** With the topoconfig file prepared, the Subnet Merger tool initiates the deployment of the extended fabric configuration. The tool ensures that the defined physical port states are implemented. Once the extension is in place, the IB network can be extended further as needed. The fabric extension is executed while maintaining the operational stability of the existing network.
1. **Conclusion:** The Subnet Merger tool offers a reliable and user-friendly solution for expanding InfiniBand fabrics using NDT topology files. By following the steps provided in the intuitive UI wizard, system administrators can seamlessly extend the fabric while adhering to predefined physical port states. This tool ensures the smooth operation of the fabric throughout the expansion process, eliminating disruptions and enhancing network scalability.

11.5.6.2 Subnet Merger Flow

Initial Fabric Topology

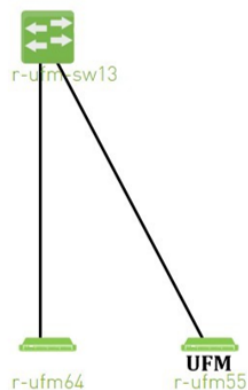

Target Fabric Topology

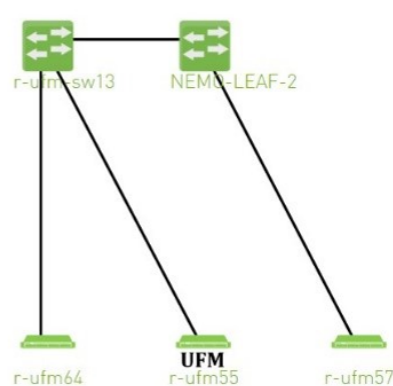

1. Create NDT, file that describes initial topology with definition of boundary ports. Boundary ports - switch ports that will be used for fabric extension. In our case it will be r-ufm-sw13 switch ports number 1 and 3. In NDT file those ports should be defined as boundary and disabled:

```
rack #,U height,#Fields:StartDevice,StartPort,StartDeviceLocation,EndDevice,EndPort,EndDeviceLocation,U
height_1,LinkType,Speed,_2,Cable Length,_3,_4,_5,_6,_7,State,Domain
,,MF0;r-ufm-sw13:MQM8700/U1,Port 1,,,,,,,,,,,,,Disabled,Boundary
,,MF0;r-ufm-sw13:MQM8700/U1,Port 30,,r-ufm55 mlx5_1,Port 1,,,,,,,,,,,,,Active,In-Scope
,,MF0;r-ufm-sw13:MQM8700/U1,Port 29,,r-ufm55 mlx5_0,Port 1,,,,,,,,,,,,,Active,In-Scope
,,MF0;r-ufm-sw13:MQM8700/U1,Port 26,,r-ufm64 mlx5_0,Port 1,,,,,,,,,,,,,Active,In-Scope
,,MF0;r-ufm-sw13:MQM8700/U1,Port 3,,,,,,,,,,,,,Disabled,Boundary
```

2. Upload a new NDT topology file which describes the desired topology. Before deploying to UFM, the new NDT topology file should be verified against the existing topology - to find out mismatches and problems.

After the verification, the plugin generates reports including information about:

- Duplicated GUIDs
 - Misswired links
 - Non-existent links in the pre-defined NDT files
 - Links that exist in the fabric and not in the NDT file
2. Following the issues detected in the plugin reports, the network administrator changes the NDT file or the fabric. The verification process can be repeated as many times as necessary until the network administrator is satisfied with the results.
 3. If the NDT verification results are satisfactory, a topoconfig file is generated and can be deployed to the UFM server to be used as configuration input for OpenSM. Topoconfig file should be located at /opt/ufm/files/conf/opensm/topoconfig.cfg on UFM server. By sending SIGHUP signal to opensm it forced to read configuration and to deploy it. In topoconfig file at this stage boundary ports will be defined as Disabled.

Example of topoconfig.cfg:

```
0xb83fd2030080302e,1,-,-,Any, Disabled
0xb83fd2030080302e,30,0xF452140300280081,1,Any,Active
0xb83fd2030080302e,29,0xF452140300280080,1,Any,Active
0xb83fd2030080302e,26,0xF452140300280040,1,Any,Active
```

```
0xb83fd2030080302e,3,-,-,Any, Disabled
```

- Next stage is to extend the fabric. Prepare separately new subnet that will be added to the existing fabric and, once it is ready, connect to the boundary ports, that are defined as Disabled in configuration file, so newly added subnet will not be discovered by opensm and will not affect in any way current setup functionality.
- Once new subnet connected to the fabric - prepare next NDT file, that contains setup, that describes current fabric with extended, when previously defined as boundary ports defined as Active and if planned to continue with extension new ports defined as boundary.
For example port number 9 of switch r-ufm-sw13:

```
rack #,U height,#Fields:StartDevice,StartPort,StartDeviceLocation,EndDevice,EndPort,EndDeviceLocation,U
height_1,LinkType,Speed,_2,Cable Length,_3,_4,_5,_6,_7,State,Domain
,,MF0;r-ufm-sw13:MQM8700/U1,Port 1,,NEMO-LEAF-2,Port 1,,,,,,,,,,,,Active,In-Scope
,,MF0;r-ufm-sw13:MQM8700/U1,Port 30,,r-ufm55 mlx5_1,Port 1,,,,,,,,,,,,Active,In-Scope
,,MF0;r-ufm-sw13:MQM8700/U1,Port 29,,r-ufm55 mlx5_0,Port 1,,,,,,,,,,,,Active,In-Scope
,,NEMO-LEAF-2,Port 11,,r-ufm57 mlx5_0,Port 1,,,,,,,,,,,,Active,In-Scope
,,MF0;r-ufm-sw13:MQM8700/U1,Port 26,,r-ufm64 mlx5_0,Port 1,,,,,,,,,,,,Active,In-Scope
,,NEMO-LEAF-2,Port 1,,MF0;r-ufm-sw13,Port 1,,,,,,,,,,,,Active,In-Scope
,,MF0;r-ufm-sw13:MQM8700/U1,Port 3,,NEMO-LEAF-2,Port 3,,,,,,,,,,,,Active,In-Scope
,,NEMO-LEAF-2,Port 3,,MF0;r-ufm-sw13,Port 3,,,,,,,,,,,,Active,In-Scope
,,MF0;r-ufm-sw13:MQM8700/U1,Port 9,,,,,,,,,,,,Disabled,Boundary
```

- After new subnet connected physically to the fabric, in opensm configuration file (topoconfig.cfg) boundary ports previously defined as Disabled should be set as No-discover.
Example:

```
0xb83fd2030080302e,1,-,-,Any,No-discover
0xb83fd2030080302e,30,0xf452140300280081,1,Any,Active
0xb83fd2030080302e,29,0xf452140300280080,1,Any,Active
0xb83fd2030080302e,26,0xf452140300280040,1,Any,Active
0xb83fd2030080302e,3,-,-,Any,No-discover
```

- Updated file should be deployed to UFM. In case boundary ports will be defined as No-discover - fabric, connected beyond those ports will not be discovered by opensm, but all the ibutils (ibdiagnet...) could send mads beyond those ports to newly added subnet - so NDT file verification for extended setup could be performed.
- Upload new NDT file and run verification for this file. Fix problems detected by verification. Once satisfied with results - deploy configuration to UFM.
Example of topoconfig file for extended setup:

```
0xb83fd2030080302e,1,0x98039b0300867bba,1,Any,Active
0xb83fd2030080302e,30,0xf452140300280081,1,Any,Active
0xb83fd2030080302e,29,0xf452140300280080,1,Any,Active
0x98039b0300867bba,11,0x248a0703009c0066,1,Any,Active
0xb83fd2030080302e,26,0xf452140300280040,1,Any,Active
0x98039b0300867bba,1,0xb83fd2030080302e,1,Any,Active
0xb83fd2030080302e,3,0x98039b0300867bba,3,Any,Active
0x98039b0300867bba,3,0xb83fd2030080302e,3,Any,Active
0xb83fd2030080302e,9,-,-,Any,Disabled
```

- Repeat previous steps if need to perform additional setup extension.

11.5.6.3 Subnet Merger UI

Bring-Up Merger Wizard

- Add the NDT plugin to UFM by loading the plugin's image through Settings->Plugins Management. A new item will appear in the main left navigator menu of the UFM labeled

"Subnet Merger".

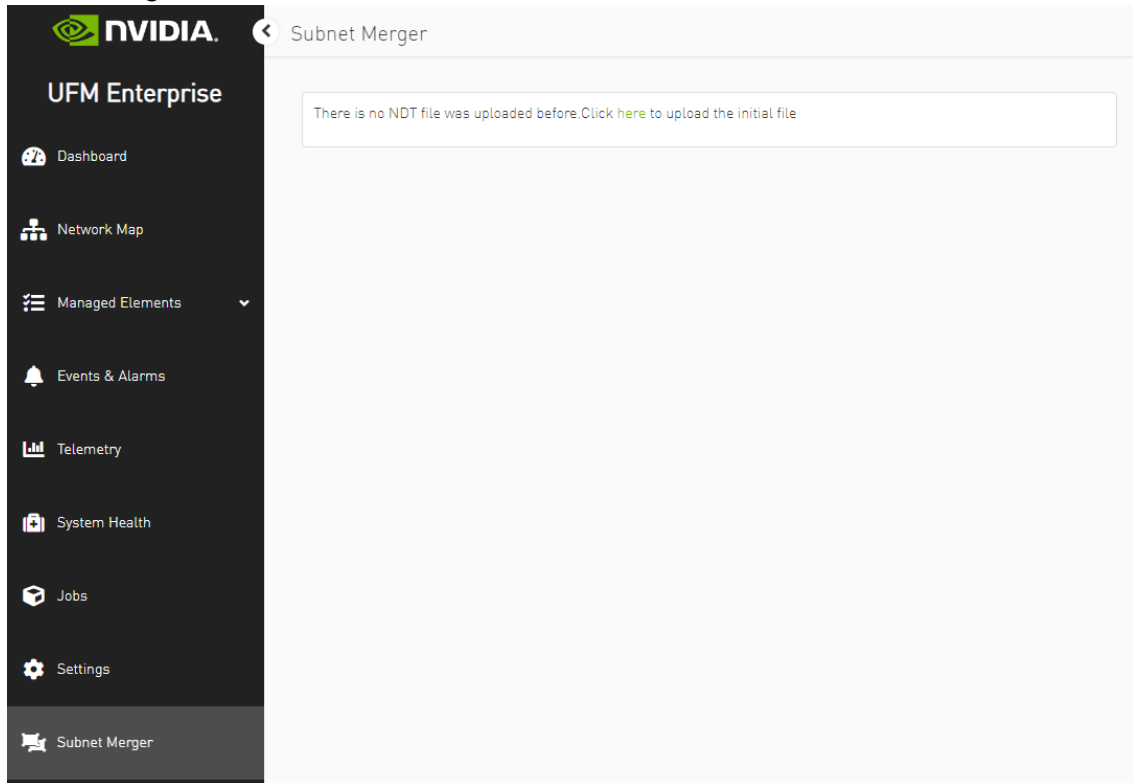

2. Access "Subnet Merger" to initiate the bring-up wizard.

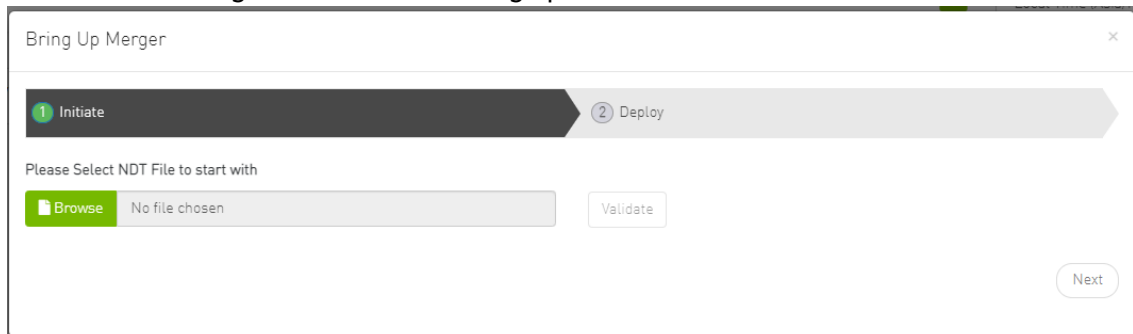

3. The wizard will guide you through the process, containing the following steps:
 - a. Upload the initial NDT tab and validate it.

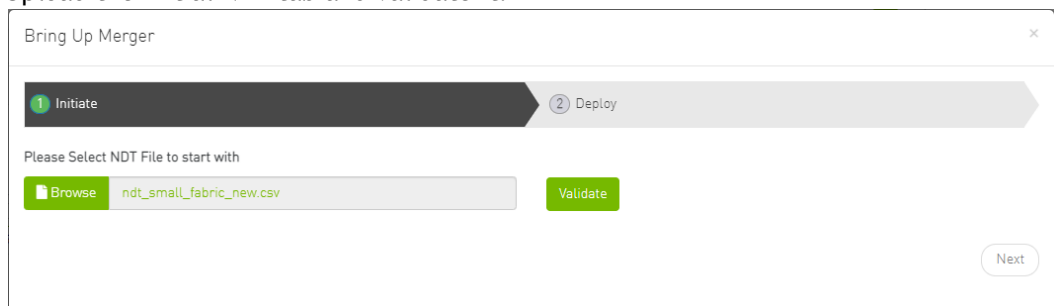

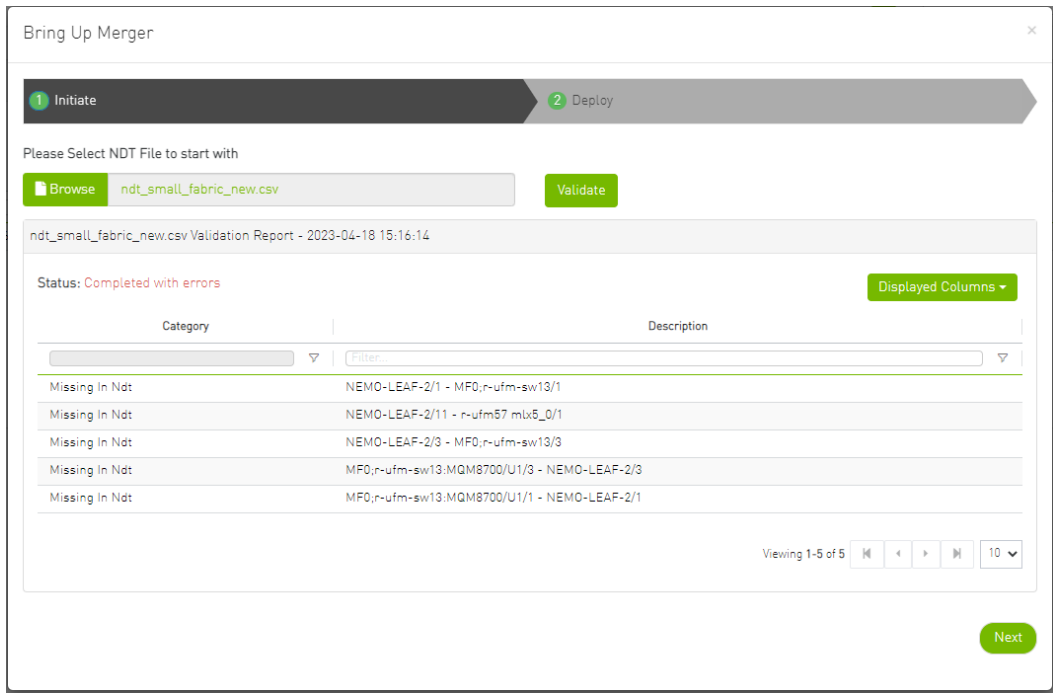

- b. Once you are satisfied with the results of the validation in the previous tab, you can proceed to deploy the file.

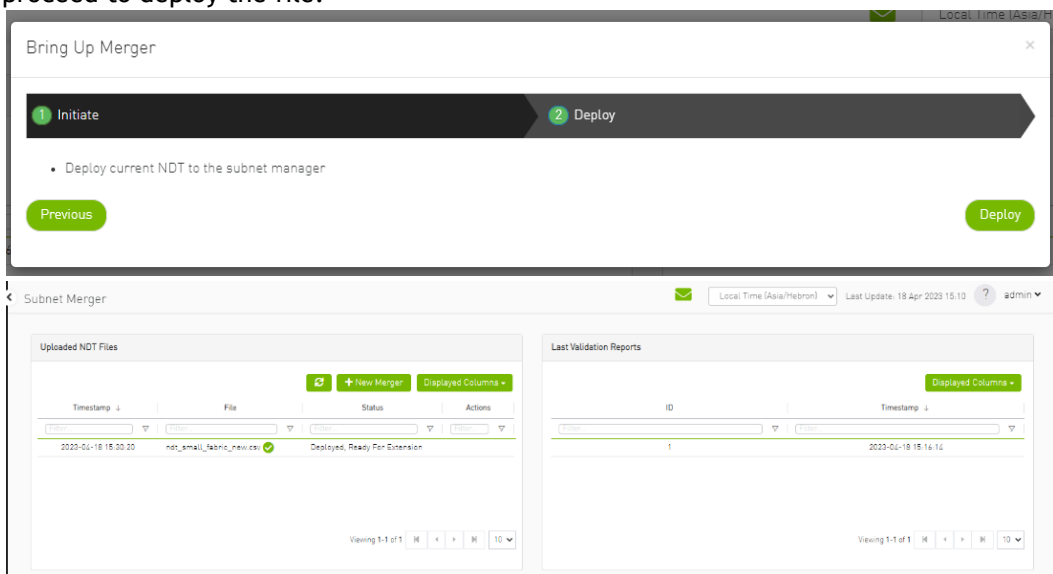

New Subnet Merger

Once you have successfully deployed the initial NDT file, you can initiate a new merger process by clicking the "New Merger" button.

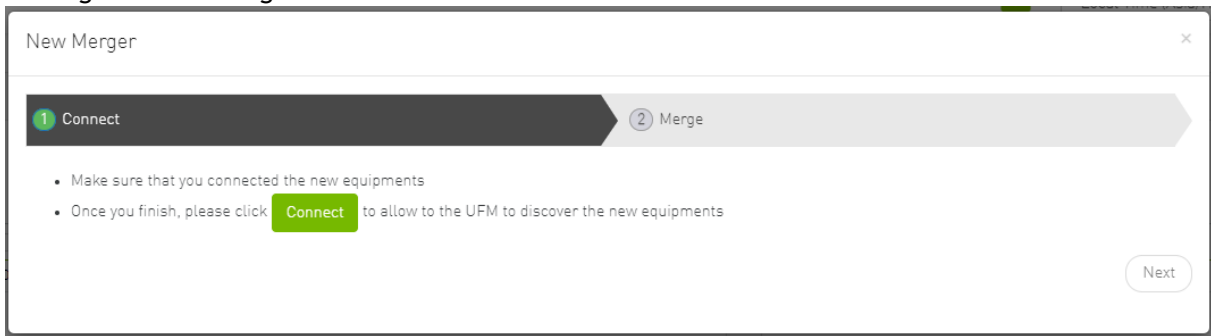

1. "Connect" Tab, it is important to physically connect the new equipment and confirm the connection. Then, click on a button which will open the boundary ports, change their state from Disabled to No-discover, and then deploy the active file again.

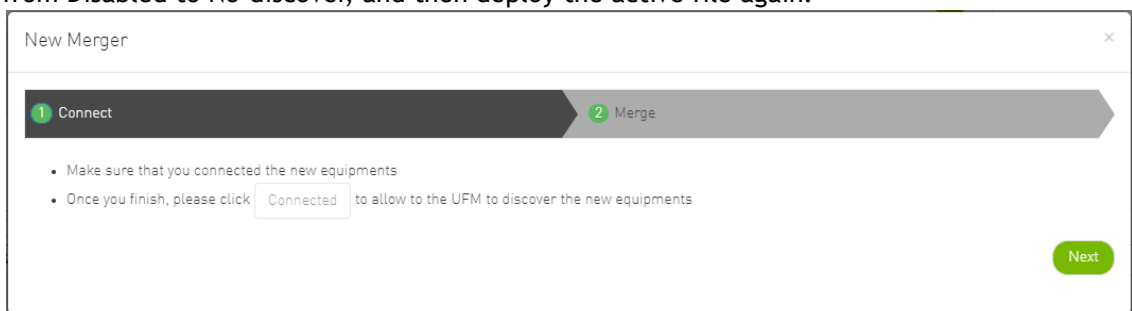

2. "Merge" Tab: Once the new equipment is connected and the boundary ports are updated, upload a new NDT file that includes both the current and newly added equipment, along with their boundary ports for future merges. Please note that you cannot merge the file if there are duplicate GUIDs in the report's results.

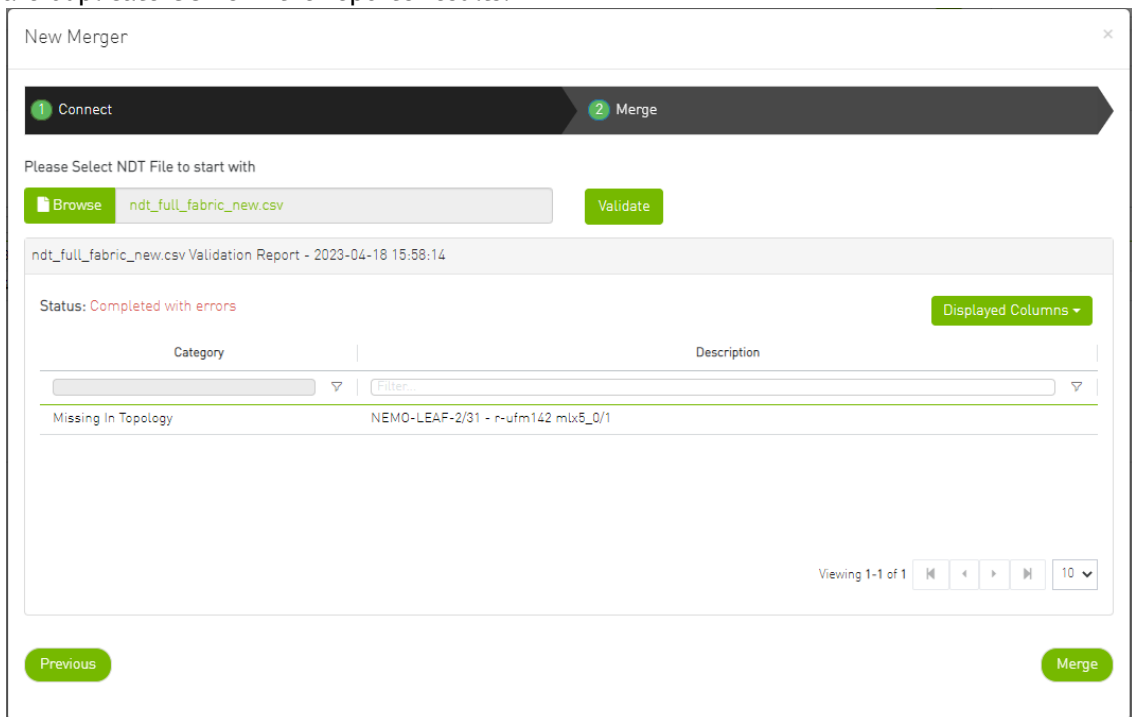

3. After completing the merge wizard, and if necessary, you can further proceed to extend the IB fabric.

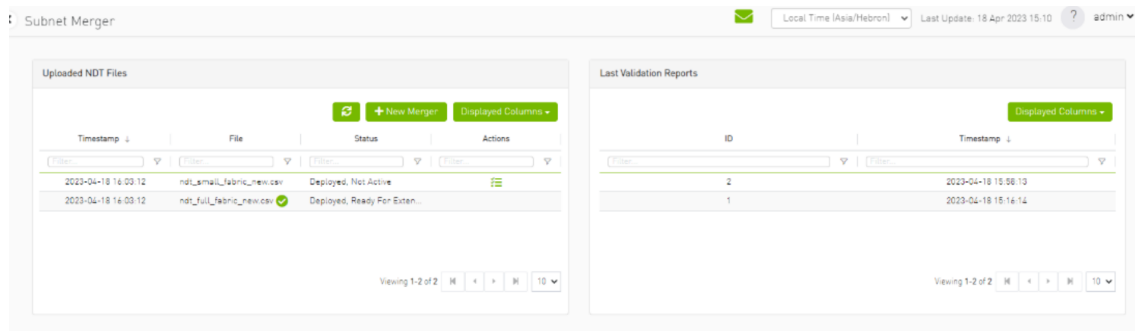

11.5.6.4 Extending the InfiniBand Setup via Subnet Merger

The following instructions outline the necessary steps for expanding the InfiniBand setup or fabric using subnet merging.

1. Step 1: NDT File Upload (Repeatable)
Upload the NDT file, performing this action as many times as required, especially when addressing file-related issues.
2. Step 2: NDT File Validation and Verification (Repeatable)
Validate the NDT file, a process that can be repeated multiple times, particularly after fixing fabric topology or NDT file errors. After initiating this call, you will obtain a validation report ID. The progress of this process is asynchronous, with the report's status initially indicated as "running." Once the report is completed, the status will change to either "Successfully completed" or "Completed with errors."
3. Step 3: Retrieving and Monitoring the Validation Report
Retrieve the validation report by its corresponding ID, running this step through continuous polling until the report reaches completion.
4. Step 4: Review and Potential Fixes
Inspect the report and address any necessary fixes to either the NDT file or the topology. Should changes be made to the file, upload the corrected NDT file anew. Alternatively, in case of topology has changed, repeat the verification process.
5. Step 5: Topology Deployment to UFM
Deploy the verified topology to UFM once you are satisfied with the verification outcomes.
6. Step 6: Adjusting Boundary Ports and Deployment
Following the physical connection of the setup extension, change the boundary ports' state from "Disabled" to "No-discover."
7. Step 7: Uploading Updated Topoconfig File
Deploy the updated topoconfig file to the UFM server.
8. Step 8: Next NDT File Upload (Combined Fabric and Extension)
Upload the next NDT file, which consolidates the current fabric and extension components.
9. Step 9: NDT File Verification
Conduct the NDT file verification process.
10. Step 10: Reviewing Verification Report
Review the verification report.

11. Step 11: Addressing Setup or NDT File Issues
If necessary, make necessary adjustments to the setup or NDT file.
12. Step 12: Final Configuration Deployment
Once content with the modifications, proceed to deploy the configuration to UFM.
13. Step 13: Iterative Workflow
Repeat this flow as many times as needed to further the expansion process.

11.6 UFM Telemetry Fluentd Streaming (TFS) Plugin

11.6.1 Overview

The TFS plugin is designed to extract UFM Telemetry counters from specified telemetry HTTP endpoints and stream them to the designated [Fluentd](#) collector destination.

The diagram below illustrates the plugin's stream flow:

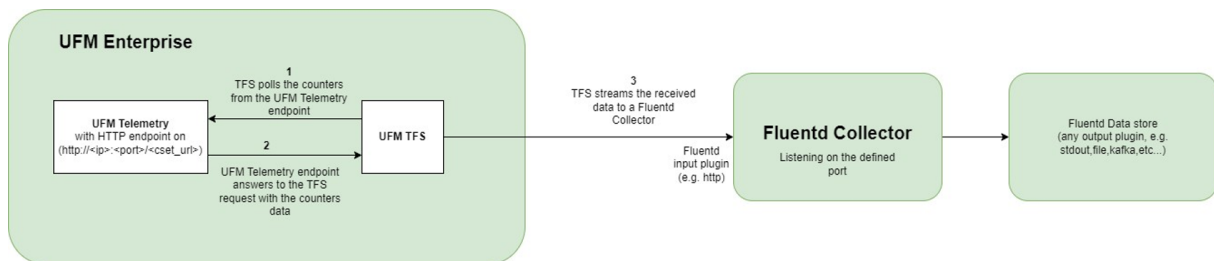

11.6.2 Deployment

The following are the possible ways the TFS plugin can be deployed:

1. On UFM Appliance
2. On UFM Software

For complete instructions on deploying the TFS plugin, refer to [UFM Telemetry endpoint stream To Fluentd endpoint \(TFS\)](#).

11.6.3 Authentication

The following authentication types are supported:

- basic (/ufmRest)
- client (/ufmRestV2)
- token (/ufmRestV3)

11.6.4 Rest API

The following REST APIs are supported:

- POST /plugin/tfs/conf
- GET /plugin/tfs/conf
- POST /plugin/tfs/conf/attributes
- GET /plugin/tfs/conf/attributes

For detailed information on interacting with TFS plugin, refer to the [NVIDIA UFM Enterprise > Rest API > TFS Plugin REST API](#).

11.7 UFM Events Fluent Streaming (EFS) Plugin

11.7.1 Overview

EFS plugin is a self-contained Docker container with REST API support managed by UFM. EFS plugin extracts the UFM events from UFM Syslog and streams them to a remote FluentD destination. It also has the option to duplicate current UFM Syslog messages and forward them to a remote Syslog destination. As a fabric manager, it will be useful to collect the UFM Enterprise events/logs, stream them to the destination endpoint and monitor them.

11.7.2 Deployment

The following are the ways EFS plugin can be deployed:

1. On UFM Appliance
2. On UFM Software

For detailed instructions on how to deploy EFS plugin, refer to [UFM Event Stream to FluentBit endpoint \(EFS\)](#).

11.7.3 Authentication

The following authentication types are supported:

- basic (/ufmRest)
- client (/ufmRestV2)
- token (/ufmRestV3)

11.7.4 Rest API

The following REST APIs are supported:

- PUT /plugin/efs/conf
- GET /plugin/efs/conf

For detailed information on how to interact with EFS plugin, refer to the [NVIDIA UFM Enterprise > Rest API > EFS Plugin REST API](#).

11.8 UFM Bright Cluster Integration Plugin

11.8.1 Overview

The Bright Cluster Integration plugin is a self-contained docker container managed by UFM and is managed by the REST APIs. It enables integrating data from Bright Cluster Manager (BCM) into UFM, providing a more comprehensive network perspective. This integration improves network-centered Root Cause Analysis (RCA) tasks and enables better scoping of workload failure domains.

11.8.2 Deployment

The Bright Cluster Integration plugin can be deployed either on the UFM Appliance or on UFM Software.

For detailed instructions on Bright Cluster Integration plugin deployment, refer to [UFM Bright Cluster Integration Plugin](#).

11.8.3 Authentication

The following authentication types are supported:

- basic (/ufmRest)
- client (/ufmRestV2)
- token (/ufmRestV3)

11.8.4 Bright Cluster Integration UI

1. After the successful deployment of the plugin, a new tab is shown under the UFM settings section for bright configurations management:

NVIDIA UFM Enterprise

- Dashboard
- Network Map
- Managed Elements
- Events & Alarms
- Telemetry
- System Health
- Jobs
- Settings**

Settings

- Events Policy
- Device Access
- Network Management
- Subnet Manager
- Non-Optimal Links
- User Management
- Email
- Remote Lo

Bright Configuration

Bright Configurations

Status: Disabled **Enabled**

Connection Status: **Healthy**

Host: 10.209.36.79 : 8081

Certificate (.pem):
-----BEGIN CERTIFICATE-----
MIIDfzCCAmegAwIBAgIBEDANBgkqhkiG9w0BAQ0FAD

Certificate Key(.key):
-----BEGIN PRIVATE KEY-----
MIIEvQIBADANBgkqhkiG9w0BAQEFAASCBKcwggSjAg

Data Retention Period: 30 Days

Save

NVIDIA UFM Enterprise

- Dashboard
- Network Map
- Managed Elements
- Events & Alarms
- Telemetry
- System Health
- Jobs
- Settings**

Settings

- Events Policy
- Device Access
- Network Management
- Subnet Manager
- Non-Optimal Links
- User Management
- Email
- Remote Lo

Bright Configuration

Bright Configurations

Status: **Disabled** Enabled

Connection Status: **Disabled**

Host: IP/Hostname : 8081

Certificate (.pem):

Certificate Key(.key):

Data Retention Period: 30 Days

Save

Fill the below required configurations:

Parameter	Description
Host	Hostname or IP of the BCM server
Port	Port of the BCM server, is typically 8081
Certificate	BMC client certificate content that could be located in the BMC server machine under <code>.cm/XXX.pem</code>
Certificate key	BMC client certificate key that could be located in the BMC server machine under <code>.cm/XXX.key</code>
Data retention period	UFM erases the data gathered in the database after the configured retention period. By default, after 30 days.

2. After you ensure you have successfully completed the plugin configuration, and that you have established a healthy connection with the BMC, navigate to the UFM Web GUI -> Managed Elements -> Devices

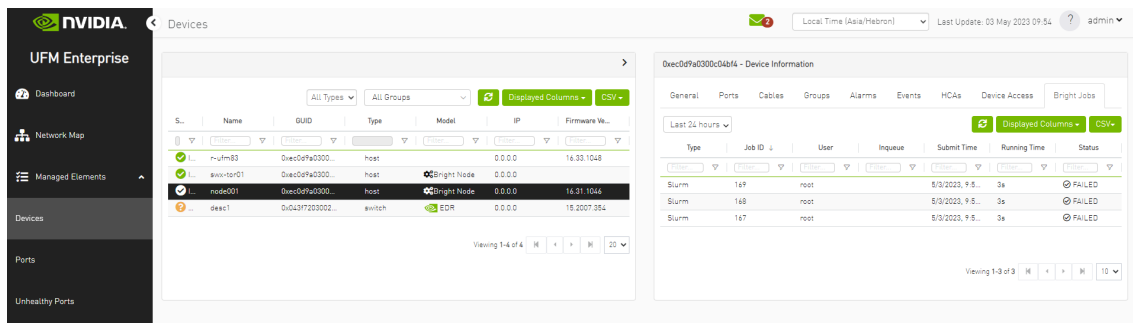

11.8.5 Rest API

The following REST APIs are supported:

- PUT plugin/bright/conf
- GET plugin/bright/conf
- GET plugin/bright/data/nodes
- GET plugin/bright/data/jobs

For detailed information on how to interact with bright plugin APIs, refer to [NVIDIA UFM Enterprise > Rest API > UFM Bright Cluster Integration Plugin REST API](#).

11.9 UFM Cyber-AI Plugin

11.9.1 Overview

The primary objective of this plugin is to integrate the UFM CyberAI product into the UFM Enterprise WEB GUI. This integration would result in both products being available within a single application.

11.9.2 Deployment

The following are the ways UFM CyberAI plugin can be deployed:

1. On UFM Appliance
2. On UFM Software

First, download the `ufm-plugin-cyberai-image` from the [NVIDIA License Portal \(NLP\)](#), then load the image on the UFM server, using the UFM GUI -> Settings -> Plugins Management tab or by loading the image via the following command:

1. Login to the [UFM server terminal](#).
2. Run:

```
docker load -I <path_to_image>
```

Once the plugin's image has been successfully loaded, you can locate the plugin in the Plugins management table within the UFM GUI. You can then run the plugin by right-clicking on the row associated with the plugin.

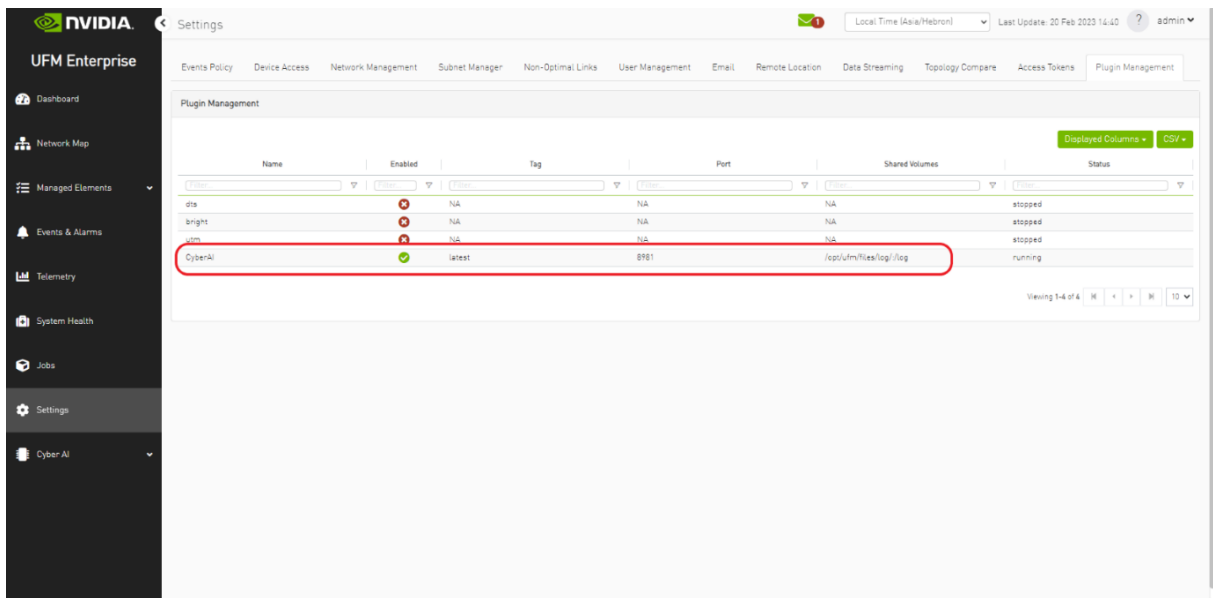

After running the plugin successfully. You should be able to see the Cyber-AI items under the main

UFM navigation menu:

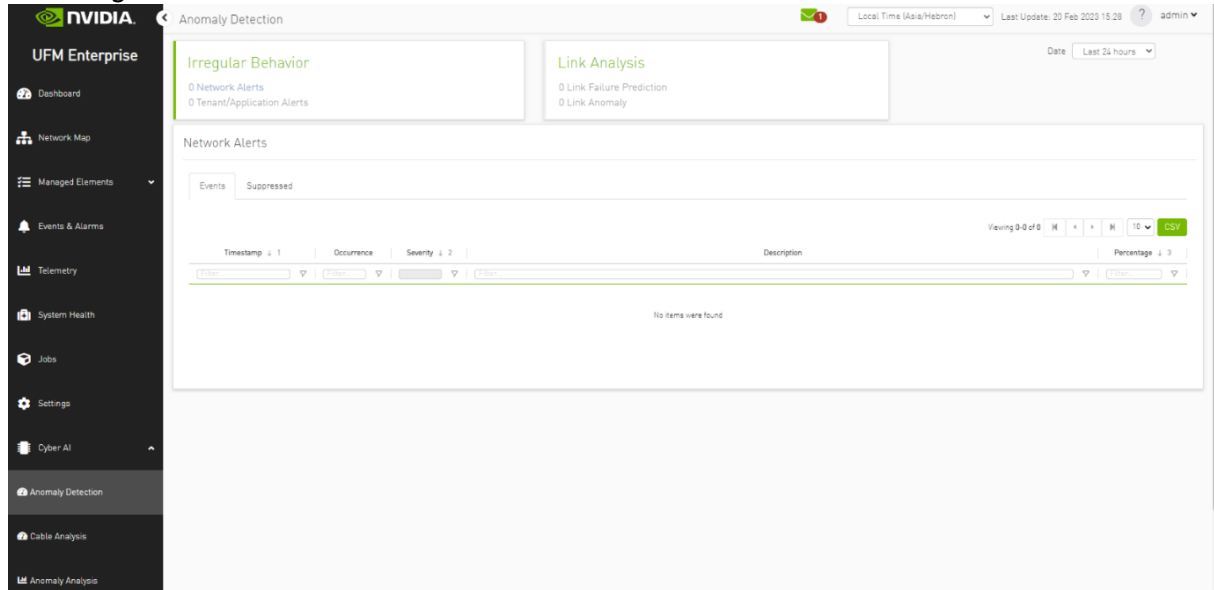

For more details, please refer to the [UFM Cyber-AI User Manual](#)

11.10 Autonomous Link Maintenance (ALM) Plugin

11.10.1 Overview

The primary objective of the Autonomous Link Maintenance (ALM) plugin is to enhance cluster availability and improve the rate of job completion. This objective is accomplished by utilizing machine learning (ML) models to predict potential link failures. The plugin then isolates the expected failing links, implements maintenance procedures on them, and subsequently restores the fixed links to their original state by removing the isolation.

The ALM plugin performs the following tasks:

1. Collects telemetry data from UFM and employs ML jobs to predict which ports need to be isolated/de-isolated
2. Identifies potential link failures and isolates them to avert any interruption to traffic flow
3. Maintains a record of maintenance procedures that can be executed to restore an isolated link
4. After performing the required maintenance, the system verifies if the links can be de-isolated and restored to operational status (brought back online)

The ALM plugin operates in the following two distinct modes:

1. Shadow mode
 - Collects telemetry data, runs ML prediction jobs, and saves the predictions to files.
2. Active mode
 - Collects telemetry data, runs ML prediction jobs, and saves the predictions to files.
 - Automatically isolates and de-isolates based on predictions.
 - It is essential to note that a subset of the links must be specified in the allow list to enable this functionality.

11.10.2 Schematic Flow

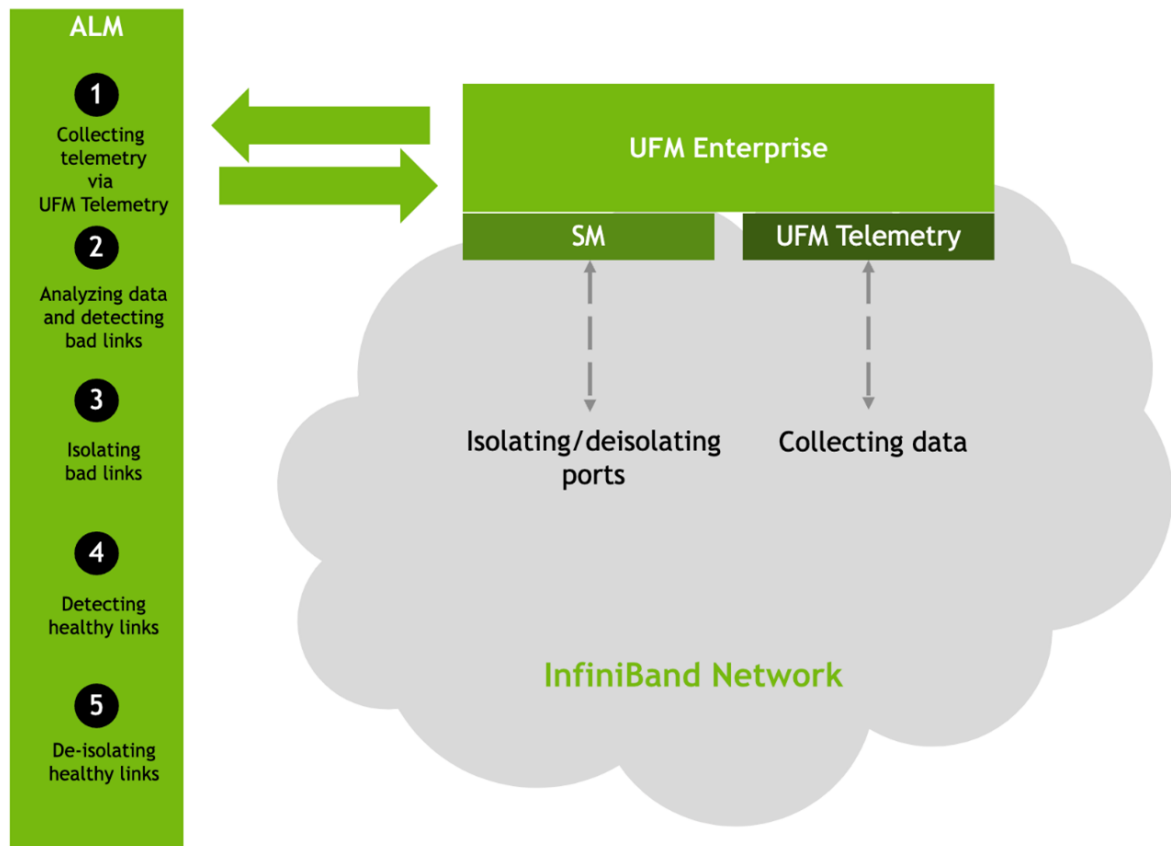

11.10.3 Deployment

The Autonomous Link Maintenance (ALM) plugin can be deployed using the following methods:

1. On the UFM Appliance
2. On the UFM Software

To deploy the plugin, follow these steps:

1. Download the `ufm-plugin-alm-image` from the [NVIDIA License Portal \(NLP\)](#).
2. Load the downloaded image onto the UFM server. This can be done either by using the UFM GUI by navigating to the Settings -> Plugins Management tab or by loading the image via the following instructions:
3. Log in to the UFM server terminal.
4. Run:

```
docker load -I <path_to_image>
```

5. After successfully loading the plugin image, the plugin should become visible within the plugins management table within the UFM GUI. To initiate the plugin's execution, simply right-click on the respective in the table.

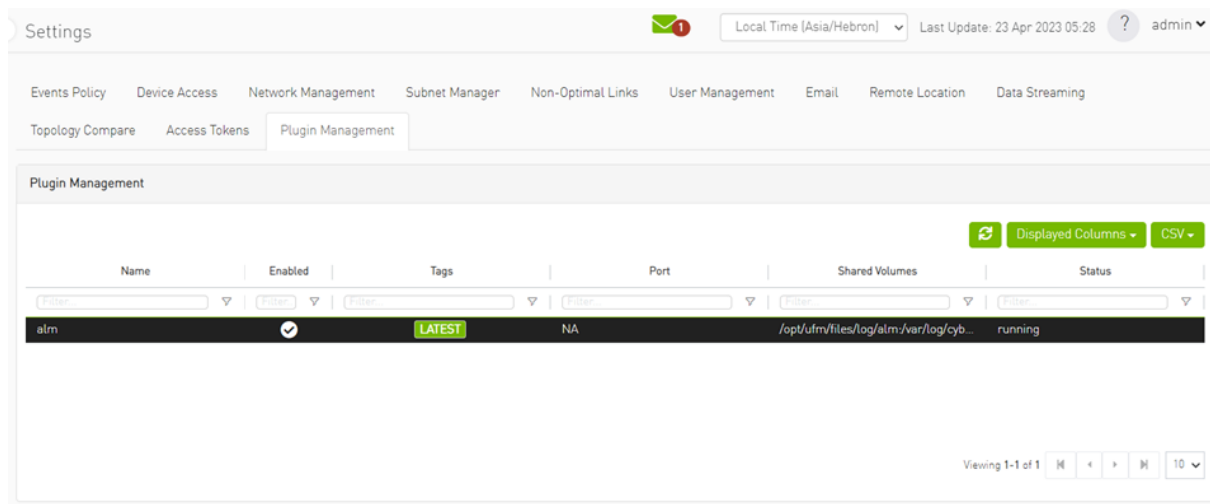

The supported InfiniBand hardware technologies are HDR, Beta on NDR.

11.10.4 Data Collection

The ALM plugin collects data from the UFM Enterprise appliance in the following two methods:

1. Low-frequency collection: This process occurs every 5 minutes in case the Alm use secondary telemetry(default) or 7 minutes when alm use adynamic telemetry api and gathers data for the following counter:
 hist0,hist1,hist2,hist3,hist4,hist5,hist6,hist7,hist8,hist9,hist10,hist11,hist12,hist13,hist14,hist15,
 phy_effective_errors,phy_symbol_errors,CableInfo.Temperature,switch_temperature,CableInfo.diag_supply_voltage,
 PortRcvErrorsExtended,PortRcvDataExtended,snr_host_lane0,snr_host_lane1,snr_host_lane2,snr_host_lane3,
 snr_media_lane0,snr_media_lane1,snr_media_lane2,snr_media_lane3,link_down_events,LinkErrorRecoveryCounterExtended,
 time_since_last_clear
2. High-frequency collection(disabled by default) : This process occurs every 10 seconds and gathers data for the following counters:
 phy_state,logical_state,link_speed_active,link_width_active,fec_mode_active,
 raw_ber,eff_ber,symbol_ber,phy_raw_errors_lane0,phy_raw_errors_lane1,phy_raw_errors_lane2, phy_raw_errors_lane3,phy_effective_errors,phy_symbol_errors,time_since_last_clear,
 hist0,hist1,hist2,hist3,hist4,switch_temperature,CableInfo.temperature,link_down_events,
 plr_rcv_codes,plr_rcv_code_err,plr_rcv_uncorrectable_code,plr_xmit_codes,plr_xmit_retry_codes, plr_xmit_retry_events,plr_sync_events,hi_retransmission_rate,fast_link_up_status,
 time_to_link_up,status_opcode,status_message,down_blame,local_reason_opcode,
 remote_reason_opcode,e2e_reason_opcode,num_of_ber_alarms,PortRcvRemotePhysicalErrorsExtended,
 PortRcvErrorsExtended,PortXmitDiscardsExtended,PortRcvSwitchRelayErrorsExtended,PortRcvConstraintErrorsExtended,

VL15DroppedExtended,PortXmitWaitExtended,PortXmitDataExtended,PortRcvDataExtended,PortXmitPktsExtended,
PortRcvPktsExtended,PortUniCastXmitPktsExtended,PortUniCastRcvPktsExtended,PortMultiCastXmitPktsExtended,PortMultiCastRcvPktsExtended

3. The collected counters can be configurable and customized to suit your requirements. The counters can be found at /opt/ufm/conf/plugins/alm/counters.cfg

```
root@r-ufm116:~# cat /opt/ufm/conf/plugins/alm/counters.cfg
[HighFreq]
phy_state = last_update_value
logical_state = last_update_value
link_speed_active = last_update_value
link_width_active = last_update_value
fec_mode_active = last_update_value
raw_ber = last_update_value
eff_ber = last_update_value
symbol_ber = last_update_value
phy_raw_errors_lane0 = delta
phy_raw_errors_lane1 = delta
phy_raw_errors_lane2 = delta
phy_raw_errors_lane3 = delta
phy_effective_errors = delta
phy_symbol_errors = delta
time_since_last_clear = last_update_value
hist0 = delta
hist1 = delta
hist2 = delta
hist3 = delta
hist4 = delta
switch_temperature = last_update_value
CableInfo.Temperature = last_update_value
link_down_events = delta
plr_rcv_codes = delta
plr_rcv_code_err = delta
plr_rcv_uncorrectable_code = delta
plr_xmit_codes = delta
plr_xmit_retry_codes = delta
plr_xmit_retry_events = delta
plr_sync_events = delta
hi_retransmission_rate = delta
fast_link_up_status = last_update_value
time_to_link_up = last_update_value
status_opcode = last_update_value
status_message = last_update_value
down_blame = last_update_value
local_reason_opcode = last_update_value
remote_reason_opcode = last_update_value
e2e_reason_opcode = last_update_value
num_of_ber_alarms = delta
PortRcvRemotePhysicalErrorsExtended = delta
PortRcvErrorsExtended = delta
PortXmitDiscardsExtended = delta
PortRcvSwitchRelayErrorsExtended = delta
```

11.10.5 ALM Configuration

The ALM configuration is used for controlling data collection and isolation/de-isolation. The configuration can be found under /opt/ufm/cyber-ai/conf/cyberai.cfg.

Name	Section name	Description
mode	Prediction	The mode can be either "active" or "shadow." In active mode, the ALM will enforce isolation/deisolation rules on all ports which predict to fail except those listed in the "expect" list. In shadow mode, the ALM will enforce isolation/deisolation rules on the ports listed in the "except" list, and predict to fail.
except_list	Prediction	Includes the ports that receive the opposite treatment compared to the mode. the expect list saved in location /opt/ufm/files/conf/plugin/alm/predict.csv Format: port_guid,port_number 0x1070fd03001769b4,1 0x1070fd03001769b4,3
mode	NOC	The mode can be either "active" or "shadow." In active mode, the ALM will enforce isolation/deisolation rules on all ports that considered as out of nominal condition except those listed in the "expect" list. In shadow mode, the ALM will enforce isolation/deisolation rules on the ports listed in the "except" list.
except_list	NOC	Includes the ports that receive the opposite treatment compared to the mode. the expect list saved in location /opt/ufm/files/conf/plugin/alm/noc.csv Format: port_guid,port_number 0x1070fd03001769b4,1 0x1070fd03001769b4,3
max_per_hour	Isolation	The maximum number of ports that can be isolated in a hour
max_per_week	Isolation	Maximum number of ports that can be isolated in a week
max_per_month	Isolation	Maximum number of the ports that can be isolated in a month
min_links_per_switch_pair	Isolation	Minimum links between two switches to perform isolation
min_active_ports_per_switch	Isolation	Minimum number of active ports per switch before perform isolation
Deisolation_time	Delsolation	The waiting time before deisolate the isolated port
max_per_hour	Delsolation	The maximum number of deisolated port per hour
absolute_threshold_of_isolated_ports	Isolation	The maximum number of ports than can be isolated in one sample
LowFreqCollector	use_secondary	the flag to determine if we need to use secondary telemetry or dynamic telemetry, if the flag true alm will use secondary else will use dynamic telemetry

Name	Section name	Description
LowFreqCollector	secondary_interval	the periodic interval for low frequency collection in case use secondary set to true
LowFreqCollector	interval	periodic interval for low frequency collection in case use alm dynamic telemetry

11.10.6 ALM UI

After the successful deployment of the plugin, a new item is shown in the UFM side menu for the ALM plugin:

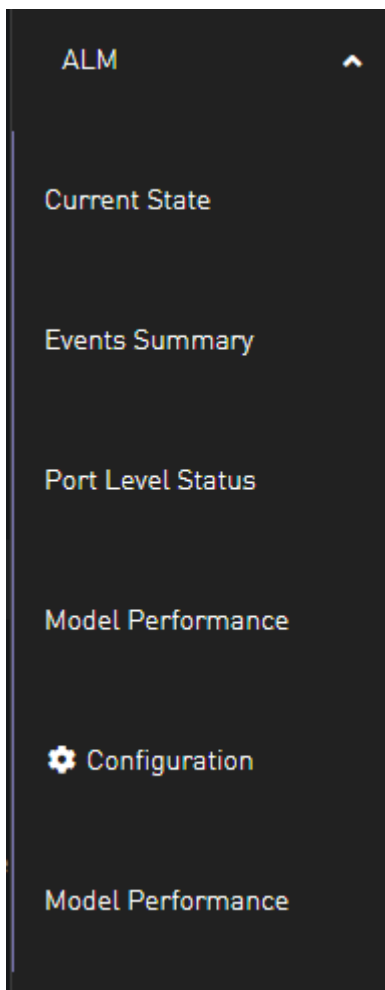

11.10.6.1 Current State

This page displays a table presenting the current cluster status, outlining the following counts:

1. Number of ports
2. Number of isolated ports
3. Number of ports in active/shadow prediction mode

4. Number of ports in active/shadow NOC mode
5. Number of ports out of NOC

Current State

Displayed Columns ▾ CSV ▾

	Switch to Switch	Switch to Host	Total, currently
Filter...	Filter...	Filter...	Filter...
Number of ports	8(57.14%)	6(42.86%)	14(100%)
Number of isolated ports	1(7.14%)	0(0%)	1(7.14%)
Number of ports in active prediction mode	8(57.14%)	6(42.86%)	14(100%)
Number of ports in shadow prediction mode	0(0%)	0(0%)	0(0%)
Number of ports in active NOC mode	0(0%)	0(0%)	0(0%)
Number of ports in shadow NOC mode	8(57.14%)	6(42.86%)	14(100%)
Out of NOC	0(0%)	0(0%)	0(0%)

Viewing 1-7 of 7 ⏪ ⏩ 10 ▾

11.10.6.2 Events Summary

This page displays a table presenting a port count summary, outlining the following counts:

1. Number of isolated ports in the past hour, week, and month for 'host to switch' and 'switch to switch'.
2. Number of de-isolated ports in the past hour, week, and month for 'host to switch' and 'switch to switch'.
3. Number of isolation actions not taken from prediction by ALM in the past hour, week, and month for 'host to switch' and 'switch to switch'.
4. Number of isolation actions not taken from NOC by ALM in the past hour, week, and month for 'host to switch' and 'switch to switch'.

Events Summary

Displayed Columns ▾ CSV ▾

	Switch to Switch			Switch to Host		
	Past Hour	Past Week	Past Month	Past Hour	Past Week	Past Month
Number of isolation	1	2	2	0	0	0
Number of de-isolation	1	2	2	0	0	0
Number of isolation actions not taken from prediction	3	4	4	0	0	0
Number of isolation actions not taken from NOC	0	0	0	0	0	0

Viewing 1-4 of 4 ⏪ ⏩ 10 ▾

11.10.6.3 Port Level Status

This page displays a table presenting the cluster ports.

Port Level Status

Displayed Columns ▾ CSV ▾

Node ID	Port Number	Prediction Mode	NOC Mode	Isolation Status	Type	Last Recommendation	Last Recommendation Time	Last Action	Last Action Time	Last Reason
0x248a070300bee960	9	active	shadow	Health	switch_switch	NA	N/A	NA	N/A	NA
0x043f7203001949c0	3	active	shadow	Health	switch_switch	NA	N/A	NA	N/A	NA
0x043f7203001949c0	6	active	shadow	Health	switch_switch	NA	N/A	NA	N/A	NA
0x98039b0300afe80	13	active	shadow	De_Isolate	switch_switch	NA	N/A	De-Isolation	N/A	UFM_User
0x0c42a103005bf438	1	active	shadow	Health	host_switch	NA	N/A	NA	N/A	NA
0x1070f03001769b4	1	active	shadow	Health	host_switch	NA	N/A	NA	N/A	NA
0x98039b030000e6ec6	1	active	shadow	Health	host_switch	NA	N/A	NA	N/A	NA
0x98039b0300afe80	11	active	shadow	Health	switch_switch	NA	N/A	NA	N/A	NA
0x043f720300206630	1	active	shadow	Health	switch_switch	NA	N/A	NA	N/A	NA
0x248a070300bee960	7	active	shadow	Health	switch_switch	NA	N/A	NA	N/A	NA

Viewing 1-10 of 14 ⏪ ⏩ 10 ▾

11.10.6.4 Configuration

This page displays ALM plugin configuration update method.

The ALM configuration is divided into four sections:

- General Configurations

General Configurations ▼

Max Number of Isolated Ports by ALM

Max Number of Isolated by ALM Per Time Window
 Hour Day Week Month

Max Number of De-isolated by ALM Per Time Window
 Hour

Minimum Time Port Should be Healthy Before De-isolation
 Minutes

Minimum Number of Links Between Two Switches

Minimum Number of Active Ports Per Switch

- Prediction Mode

Prediction Mode ▼

Default Mode
 Active Shadow

Exception List
 ▼

- NOC Mode

NOC Mode ? ▼

Default Mode
 Active Shadow

Exception List
 ▼

- ML Model Configurations

ML Model Configurations ▼

Threshold

11.10.7 ALM Jobs

The table presented below displays the names and descriptions of ALM jobs. These jobs are designed to predict the ports that require isolation/de-isolation. Upon enabling the ALM plugin, these ALM jobs run periodically.

ALM Job Name	Description	Frequency
Port_hist	By using the low frequency bit error histogram counters, the ALM job identifies the ports that will be monitored at high frequency in the next time interval. The job generates an output file that is later read by the high frequency telemetry monitoring job. It prioritizes links that are more susceptible to failure.	5 mins or 7 mins based on configuration
Low_freq_predict	Predicts the likelihood of a port failure by analyzing input data from low frequency telemetry, while only utilizing physical layer counters. The prediction works for isolated ports as well. The resulting output from this task serves as a critical input for determining whether to isolate or de-isolate ports.	5 mins or 7 mins based on configuration
Data Filter	Due to the vast amounts of data generated by the ALM in real time, it's impossible to store all the data for offline analysis. As such, the data filter applies a set of rules to select the N (N << total number of ports in cluster) "most interesting" ports in a given timepoint based on the current, past and future telemetry data. The data of the selected ports will persist for a longer time period, and thus enable to use it offline for debug, model validation, model training and so forth.	5 mins or 7 mins based on configuration
Metric Filter	This job maintains only data samples that are needed for the purpose of online calculation of the model's performance. Specifically, it will only collect samples where a failure was either predicted or actually occurred (e.g. there was an event of packet drop or symbol error). This filtering is required in order to enable the performance calculation to be executed for the entire history of the running plugin, without having to store excessive amounts of data.	5 mins or 7 mins based on configuration

11.11 ClusterMinder Plugin

This plugin is supported on UFM Enterprise Appliance only.

11.11.1 Overview

The ClusterMinder plugin collects telemetry data from multiple data sources and aggregates, streams and visualizes the backed. The plugin can cluster/group aggregated Redfish data from multiple machines that allows operational anomaly and misconfigurations detection. The plugin provides Cluster-wide histograms of hardware telemetry which details compute node configuration and inventory, PCIe bus, hardware information (SN and FW version) and health alerts of all relevant devices on each Redfish category.

The plugin can be deployed as a container and supports multiple data sources, including:

- Redfish on Host
- Redfish on DPU
- MLNX Switch Data
- DOCA Telemetry Service on DPU (BlueField)
- DOCA Telemetry Service on Host
- Unmanaged InfiniBand Switches

11.11.2 Deployment

The plugin can be deployed using the following methods:

1. On the UFM Appliance
2. On the UFM Software

To deploy the plugin, follow these steps:

- The plugin is included in the default plugin bundle available at [NVIDIA's Licensing Portal](#).
- Load the downloaded image onto the UFM server. This can be done either by using the UFM GUI by navigating to the Settings -> Plugins Management tab or by loading the image via the following instructions:
 - Log in to the UFM server terminal.
 - Run:

```
docker load < <path_to_image>
```

- After successfully loading the plugin image, the plugin should become visible within the plugins management table within the UFM GUI. To initiate the plugin's execution, simply right-click on the respective in the table.

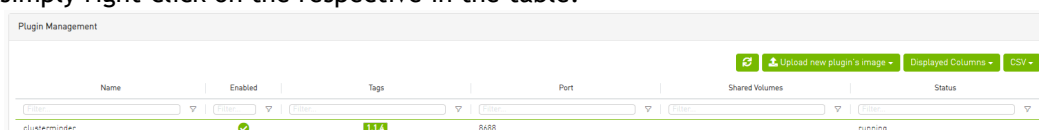

Name	Enabled	Tags	Port	Shared Volumes	Status
clusterminder	<input checked="" type="checkbox"/>	1.1.4	8688		running

11.11.3 ClusterMinder Plugin UI

After the successful deployment of the plugin, a new item is shown in the UFM side menu for the ClusterMinder plugin:

11.11.3.1 Example of Adding Data Source

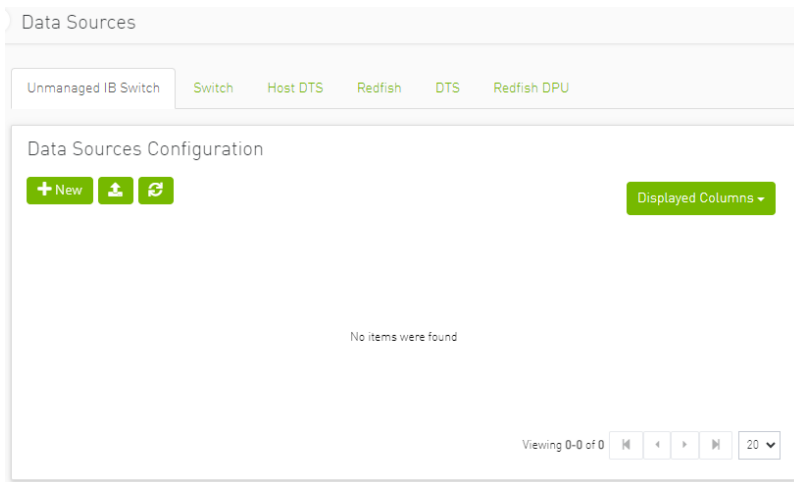

11.11.3.2 Example of Adding the Redfish Host

After inputting the "BMC IP", "Protocol", "Username" and "Password". Pressing the button tests the connection and allows to hosts if successful.

New Source
×

BMC IP

Protocol

Username

Password

Test Result: ✔

bmc_ip	username	protocol	status
<input type="text" value="Filter..."/>	<input type="text" value="Filter..."/>	<input type="text" value="Filter..."/>	<input type="text" value="Filter..."/>
hgx-isr1-pre-03-bmc	redfish	https	Up
hgx-isr1-pre-02-bmc	redfish	https	Up
hgx-isr1-pre-04-bmc	redfish	https	Up
hgx-isr1-pre-01-bmc	redfish	https	Up

Viewing 1-4 of 4

11.11.3.3 Example of Removing Data Source

Removing hosts is done through the "Data Sources" section, Right click any available host and click the remove option.

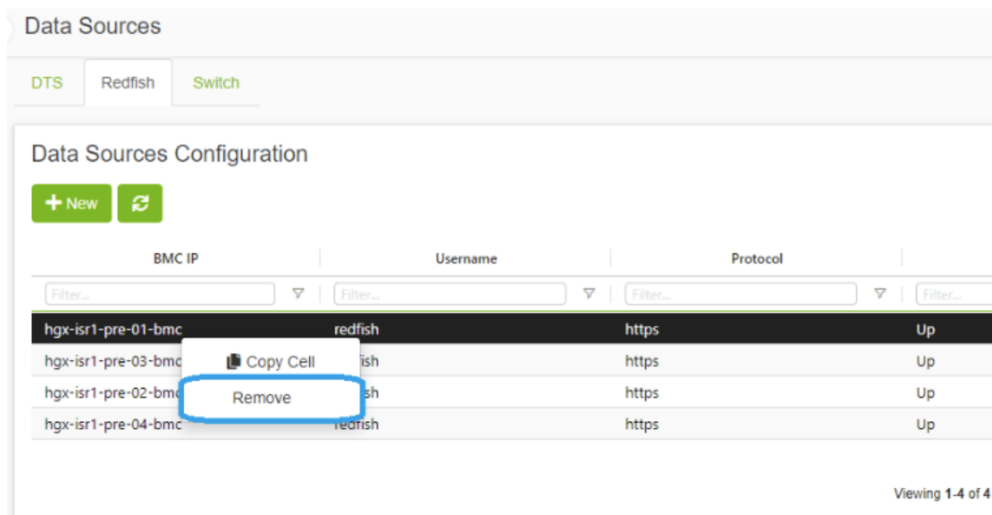

11.12 GRPC-Streamer Plugin

11.12.1 Authentication

The following authentication types are supported:

- Basic (/ufmRest)
- Token (/ufmRestV3)

11.12.2 Create a Session to UFM from GRPC

Description: Creates a session to receive REST API results from the UFM's GRPC server. After a stream or one call, the session is deleted so the server would not save the authorizations.

- Call: CreateSession in the grpc
- Request Content Type - message SessionAuth
- Request Data:

```
message SessionAuth{
  string job_id=1;
  string username = 2;
  string password = 3;
  optional string token = 4;
}
```

- Job_id - The unique identifier for the client you want to have
- Username - The authentication username
- Password - The authentication password
- Token - The authentication token
- Response:

```
message SessionRespond{
  string respond=1;
}
```

- Respond types:
 - Success - Ok.

- ConnectionError - UFM connection error (bad parameters or UFM is down).
- Other exceptions - details sent in the respond.
- Console command:

```
client session --server_ip=server_ip --id=client_id --auth=username,password --token=token
```

11.12.3 Create New Subscription

- Description: Only after the server has established a session for this grpc client, add all the requested REST APIs with intervals and delta requests.
- Call: AddSubscriber
- Request Content Type - Message SubscriberParams
- Request Data:

```
message SubscriberParams{
  message APIParams {
    string ufm_api_name = 1;
    int32 interval = 2;
    optional bool only_delta = 3;
  }
  string job_id = 1;
  repeated APIParams apiParams = 2;
}
```

- Job_id - A unique subscriber identifier
- apiParams - The list of apiParams from the above message above:
 - ufm_api_name - The name from the known to server request api list
 - interval - The interval between messages conducted in a stream run. Presented in seconds.
 - only_delta - Receives the difference between the previous messages in a stream run.
- Response content type:

```
message SessionRespond{
  string respond=1;
}
```

- Respond Types:
 - Created a user with session and added new IP- Ok.
 - Cannot add subscriber that do no have an established session - need to create a session before creating subscriber.
 - The server already have the ID - need to create new session and new subscriber with a new unique ID.
- Console command:

```
client create --server_ip=localhost --id=client_id --apis=events;40;True,links,alarms;10
```

The API's list is separated by commas, and each modifier for the REST API is separated by a semi comma.

If the server is not given a modifier, default ones are used (where only_delta is False and interval is based on the API).

11.12.4 Edit Known Subscription

- Description: Changes a known IP. Whether the server has the IP or not.
- Call: AddSubscriber
- Request Content Type - Message SubscriberParams
- Request Data:

```
message SubscriberParams{
  message APIParams {
    string ufm_api_name = 1;
    int32 interval = 2;
    optional bool only_delta = 3;
  }
  string job_id = 1; //unique identifier for this job
  repeated APIParams apiParams = 2;
}
```

- Job_id - The subscriber unique identifier
- apiParams - A list of apiParams from the above message.
 - ufm_api_name - name from the known to server request api list
 - interval - The interval between messages conducted in a stream run. Presented in seconds.
 - only_delta - Receives the difference between the previous messages in a stream run.
- Response content type:

```
message SessionRespond{
  string respond=1;
}
```

- Respond Types:
 - Created user with new IP- Ok.
 - Cannot add subscriber without an established session - need to create a session before creating subscriber.
 - Cannot add subscriber illegal apis - cannot create subscriber with empty API list, call again with correct API list.

11.12.5 Get List of Known Subscribers

- Description: Gets the list of subscribers, including the requested list of APIs.
- Call: ListSubscribers
- Request Content Type: google.protobuf.Empty
- Response:

```
message ListSubscriberParams{
  repeated SubscriberParams subscribers = 1;
}
```

- Console command: server subscribes --server_ip=server_ip

11.12.6 Delete a Known Subscriber

- Description: Deletes an existing subscriber and removes the session.
- Call: DeleteSubscriber
- Request Content Type: Message gRPCStreamerID
- Request Data:

```
message gRPCStreamerID{
  string job_id = 1;
}
```

- Response:protobuf.Empty

11.12.7 Run a Known Subscriber Once

- Description: Runs the Rest API list for a known subscriber once and returns the result in message runOnceRespond, and then delete the subscriber's session.
- Call: RunOnceJob
- Request Content Type: Message gRPCStreamerID
- Request Data:

```
message gRPCStreamerID{
  string job_id = 1;
}
```

- Response content type:

```
message runOnceRespond{
  string job_id=1;
  repeated gRPCStreamerParams results = 2;
}
```

- Job_id- The first message unique identifier.
- Results - list of gRPCStreamerParams contains results from each REST API
- Responses:
 - Job id - Cannot run a client without an established session. Empty results - an existing session for this client is not found, and the client is not known to the server.
 - Job id - Cannot run the client without creating a subscriber. Empty results - a session was created for the client but the subscription is not created.
 - Job_id - Cannot connect to the UFM. empty result - the GRPC server cannot connect to the UFM machine and receive empty results, because it cannot create a subscriber with an empty API list. This means that the UFM machine is experiencing a problem.
 - Job_id - The first unique message identifier of the messages. Not empty results - Ok
- Console command:

```
client once_id --server_ip=server_ip --id=client_id
```

11.12.8 Run Streamed Data of a Known Subscriber

- Description: Run a stream of results from the Rest API list for a known Subscriber and return the result as iterator, where each item is message gRPCStreamerParams. at the end, delete the session.
- Call: RunStreamJob
- Request Content Type: Message gRPCStreamerID
- Request Data:

```
message gRPCStreamerID{
  string job_id = 1;
}
```

- Response content type: iterator of messages gRPCStreamerParams

```
message gRPCStreamerParams{
  string message_id = 1; // unique identifier for messages
  string ufm_api_name = 2; // what rest api receive the data from
  google.protobuf.Timestamp timestamp = 3; //what time we created the message, can be converted to Datetime
  string data = 4; // data of rest api call
}
```

- Response:
 - One message only containing "Cannot run a client without a session" - A session has not been established
 - No message - A session and/or a subscriber with this ID does not exist.
 - Messages with interval between with the modifiers - Ok
- Console command:

```
client stream_id --server_ip=server_ip --id=client_id
```

11.12.9 Run a New Subscriber Once

- Description: After ensuring that a session for this specific job ID is established, the server runs the whole REST API list for the new subscriber once and returns the following result in message `runOnceRespond`. This action does not save the subscribe ID or the established session in the server.
- Call: RunOnce
- Request Content Type: Message SubscriberParams
- Request Data:

```
message SubscriberParams{
  message APIParams {
    string ufm_api_name = 1;
    int32 interval = 2;
    optional bool only_delta = 3;
  }
  string job_id = 1; //unique identifier for this job
  repeated APIParams apiParams = 2;
}
```

- Response content type:

```
message runOnceRespond{
  string job_id=1;
  repeated gRPCStreamerParams results = 2;
}
```

- Responses:
 - Job id = Cannot run a client without an established session. Empty results - no session for this client.
 - Job_id = 0 - The GRPC server cannot connect to the UFM machine and receive empty results, or it cannot create a subscriber with an empty API list.
 - Job_id = The messages' first unique identifier, and not an empty result - Ok.
- Console command:

```
client once --server_ip=server_ip --id=client_id --auth=username,password --token=token --apis=events;40;True,links;20;False,alarms;10
```

- The console command creates a session for this specific client.
- A token or the basic authorization is needed, not both.

11.12.10 Run New Subscriber Streamed Data

- Description: After the server checks it has a session for this job ID, Run a stream of results from the Rest API list for a new Subscriber and return the result as iterator, where each item is message gRPCStreamerParams. at the end, delete the session.
- Call: RunPeriodically
- Request Content Type: Message SubscriberParams
- Request Data:

```
message SubscriberParams{
  message APIParams {
    string ufm_api_name = 1;
    int32 interval = 2;
    optional bool only_delta = 3;
  }
  string job_id = 1; //unique identifier for this job
  repeated APIParams apiParams = 2;
}
```

- Response content type: iterator of messages gRPCStreamerParams
- Response:
 - Only one message with data equals to Cant run client without session - no session
 - Messages with intervals between with the modifiers - Ok
- Console command:

```
client stream --server_ip=server_ip --id=client_id --auth=username,password --token=token --apis=events;40;True,links;20;False,alarms;10
```

- console command also create session for that client.
- no need for both token and basic authorization, just one of them.

11.12.11 Run A Serialization on All the Running Streams

- Description: Run a serialization for each running stream. The serialization will return to each of the machines the results from the rest api list.
- Call: Serialization
- Request Content Type: google.protobuf.Empty
- Response: google.protobuf.Empty

11.12.12 Stop a Running Stream

- Description: Cancels running stream using the client id of the stream and stop it from outside, If found stop the stream.
- Call: StopStream

- Request Content Type: Message gRPCStreamerID
- Request Data:

```
message gRPCStreamerID{
  string job_id = 1;
}
```

- Response: google.protobuf.Empty

11.12.13 Run a subscribe stream

- Description: Create a subscription to a client identifier, all new messages that go to that client, will be copied and also sent to this stream.
- Call: Serialization
- Request Content Type: message gRPCStreamerID
- Response: iterator of messages gRPCStreamerParams

```
message gRPCStreamerParams{
  string message_id = 1; // unique identifier for messages
  string ufm_api_name = 2; // what rest api receive the data from
  google.protobuf.Timestamp timestamp = 3; //what time we created the message, can be converted to Datetime
  string data = 4; // data of rest api call
}
```

- the identifier may or may not be in the grpc server.
- Cannot be stop streamed using StopStream.
- Console command:

```
client subscribe --server_ip=server_ip --id=client_id
```

11.12.14 Get the variables from a known subscriber

- Description: Get the variables of known subscriber if found, else return empty variables.
- Call: GetJobParams
- Request Content Type: message gRPCStreamerID
- Response:

```
message SubscriberParams{
  message APIParams {
    string ufm_api_name = 1; //currently the list of api from ufm that are supported are [Jobs, Events,
Links, Alarms]
    int32 interval = 2;
    optional bool only_delta = 3;
  }
  string job_id = 1; //unique identifier for this job
  repeated APIParams apiParams = 2;
}
```

11.12.14.1 Get Help / Version

- Description: Get help and the version of the plugin, how to interact with the server. What stages need to be done to extract the rest apis (Session>run once/stream or Session>AddSubscriber>once_id/stream_id)
- Call: Help or Version
- Request Content Type: google.protobuf.Empty
- Response:

```
message SessionRespond{
  string respond=1;
}
```

11.13 Sysinfo Plugin

11.13.1 Overview

The Sysinfo plugin is a Docker container that is managed by UFM and comes with REST API support. Its purpose is to allow users to run commands and extract information from managed switches. This feature enables users to schedule runs at regular intervals and execute commands on switches directly from UFM.

The plugin takes care of managing sessions to the switches and can extend them if necessary. It also enables users to send both synchronous and asynchronous commands to all the managed switches. Additionally, it can intersect the given switches with the running UFM to ensure that only those switches that are on the UFM are activated.

11.13.2 Deployment

The following are the possible ways plugin plugin can be deployed:

1. On UFM Appliance
2. On UFM Software.
3. Authentication

Following authentication types are supported:

- basic (/ufmRest)
- client (/ufmRestV2)
- token (/ufmRestV3)

11.13.3 REST API

The following REST APIs are supported:

- GET /help
- GET /version
- POST /query
- POST /update
- POST /cancel
- POST /delete

11.13.4 Sysinfo Query Format

The Sysinfo plugin is responsible for extracting basic data needed to create a query. This is done using the following five fields:

1. Switches - An array of switch IP addresses. If this field is left empty, the plugin will gather all switches from the running UFM.

2. Callback - The URL location to which the answers should be sent.
3. Commands - An array of commands that need to be executed.
4. Schedule_run - An optional field used to set intervals for running the commands. The interval can be specified in seconds and can be set to run until a certain duration or end time. The start time can also be controlled.

There are additional flags for a configurable query:

- `ignore_ufm=True`: Does not check the UFM for switches or intersect it with given switches
- `username`: Overrides the switches' default username
- `password`: Overrides the switches' default password
- `is_async`: Rather than attempting to execute all commands simultaneously at the switch, the commands are executed one after the other in sequence.
- `one_by_one=False`: Instead of sending results from each switch as soon as information is obtained, all data is sent at once to the callback. This change eliminates multiple small sends and replaces them with a single large send.

For detailed information on how to interact with Sysinfo plugin, refer to the [NVIDIA UFM Enterprise > Rest API > Sysinfo Plugin REST API](#).

11.14 SNMP Plugin

The SNMP plugin is a self-contained Docker container that includes REST API support and is managed by UFM. Its primary function is to receive SNMP traps from switches and forward them to UFM as external events. This feature enhances the user experience by providing additional information about switches in the InfiniBand fabric via UFM events and alarms.

11.14.1 Deployment

There are two potential deployment options for the SNMP plugin:

- On UFM Appliance
- On UFM Software

For detailed instructions on how to deploy the SNMP plugin, refer to [this page](#).

11.14.2 Authentication

The following authentication types are supported:

- basic (/ufmRest)
- client (/ufmRestV2)
- token (/ufmRestV3)

11.14.3 REST API

The following REST API are supported:

- GET /switch_list
- GET /trap_list

- POST /register
- POST /unregister
- POST /enable_trap
- POST /disable_trap
- GET /version

For more information, please refer to [UFM Enterprise Documentation](#) → UFM REST API → SNMP Plugin REST API.

11.14.4 Usage

By default, upon initialization, the SNMP plugin captures traps from all switches within the fabric. However, this behavior can be modified through configuration settings utilizing the "snmp_mode" option, with available values of "auto" or "manual".

It is important to ensure that the switch is visible to UFM and has a valid IP address. As illustrated in the following example, switch traps will only be received from "r-ufm-sw61".

Severity	Name	GUID	Type	Model	IP	Firmware Version
Info	r-ufm-248	0x10709d03001763ec	host		192.168.1.30	16.35.2000
Info	r-ufm-247	0x248a070300054548	host		0.0.0.0	12.29.312
Info	r-ufm-sw61	0xe41d2d03000a2200	switch	SW6012	10.209.36.61	9.4.5070
Info	r-ufm-sw62	0x7c4e03000fceb0	switch	MSB7700	0.0.0.0	11.2008.3336

The following is an instance of a trap received by the SNMP plugin and displayed as a UFM event:

Severity	Event Name	Source	Description	Category
Critical	General External Event Error	Grid	SNMP traps from 10.209.24.108: 'oid=MELLANOX-EFM-MIB::systemHealthStatus, MELLANOX-EFM-MIB::mHealthStatus 1 = Power Supply 2 is unresponsive', happened 1 times	
Critical	General External Event Error	default / Switch: r-ufm-sw61	SNMP traps from r-ufm-sw61: 'oid=MELLANOX-EFM-MIB::systemHealthStatus, MELLANOX-EFM-MIB::mHealthStatus 1 = Power Supply 1 is unresponsive', happened 1 times	
Critical	Disk utilization threshold reached	Grid	Disk space usage in /opt/ufm/tes/ log is above the threshold of 90.0%	
Warning	General External Event Alert	default / Switch: r-ufm-sw61	SNMP traps from r-ufm-sw61: 'oid=MELLANOX-EFM-MIB::testTrap, IF-MIB::IPAddress2 = ei-16.26.60.91.20', happened 1 times	

Additionally, there is an option to verify events/alarms for a particular switch:

Severity	Date/Time	Event Name	Source	Source	Description
Critical	2023-04-25 16:16:35	General External Event Error	default / Switch: r-ufm-sw61	Switch	SNMP traps from
Critical	2023-04-25 16:14:32	General External Event Error	default / Switch: r-ufm-sw61	Switch	SNMP traps from
Critical	2023-04-25 16:12:27	General External Event Error	default / Switch: r-ufm-sw61	Switch	SNMP traps from
Warning	2023-04-25 15:21:51	General External Event Alert	default / Switch: r-ufm-sw61	Switch	SNMP traps from
Warning	2023-04-25 14:50:46	General External Event Alert	default / Switch: r-ufm-sw61	Switch	SNMP traps from
Critical	2023-04-25 14:05:49	General External Event Error	default / Switch: r-ufm-sw61	Switch	SNMP traps from
Warning	2023-04-25 14:03:58	General External Event Alert	default / Switch: r-ufm-sw61	Switch	SNMP traps from

The SNMP plugin performs a periodic check of the fabric every 180 seconds, allowing for prompt receipt of traps from new switches or updated IP addresses of existing switches in under 180 seconds. This interval may be adjusted via the "ufm_switches_update_interval" option. To manually register or unregister a switch, please refer to the [UFM Enterprise Documentation](#) → UFM REST API → SNMP Plugin REST API.

The SNMP plugin employs the most up-to-date SNMP v3 protocol, which incorporates advanced security measures such as authentication and encryption. The "snmp_version" option enables the selection of SNMP versions "1" or "3". It is essential to note that only switch-exposed traps will be transmitted to UFM as events.

OID	Name	Description	Status	Severity
MELLANOX-EFM-MIB::testTrap	send-test	A test trap ordered by the system administrator	Enabled	Warning
MELLANOX-EFM-MIB::asicChipDown	asic-chip-down	ASIC (Chip) Down	Enabled	Critical
MELLANOX-EFM-MIB::cpuUtilHigh	cpu-util-high	CPU utilization has risen too high	Enabled	Warning
MELLANOX-EFM-MIB::diskSpaceLow	disk-space-low	Filesystem free space has fallen too low	Enabled	Warning
MELLANOX-EFM-MIB::expectedShutdown	expected-shutdown	Expected system shutdown	Enabled	Info
MELLANOX-EFM-MIB::systemHealthStatus	health-module-status	Health module Status	Enabled	Critical
MELLANOX-EFM-MIB::insufficientFans	insufficient-fans	Insufficient amount of fans in system	Enabled	Warning
MELLANOX-EFM-MIB::insufficientFansRecover	insufficient-fans-recover	Insufficient amount of fans in system recovered	Enabled	Info
MELLANOX-EFM-MIB::insufficientPower	insufficient-power	Insufficient power supply	Enabled	Warning
RFC1213::linkdown	interface-down	An interface's link state has changed to down	Enabled	Minor
RFC1213::linkup	interface-up	An interface's link state has changed to up	Enabled	Info
MELLANOX-EFM-MIB::unexpectedShutdown	unexpected-shutdown	Unexpected system shutdown	Enabled	Minor
SNMPv2-MIB::coldStart	cold-start	SNMP entity reinitialized	Enabled	Info

To learn more about how to enable or disable a specific trap, please refer to the [UFM Enterprise Documentation](#) → UFM REST API → SNMP Plugin REST API.

If some traps are not included in the default list, they may be added using the "snmp_additional_traps" option. The SNMP plugin will consider these traps as "enabled" and transmit them to UFM as events with an "Info" severity level.

To ensure the uninterrupted reception of traps from switches within a large fabric, changes must be made to the UFM configuration in the [/opt/ufm/conf/gv.cfg] file's [Events] section. Specifically, the "max_events" option should be raised from 100 to 1000, while "medium_rate_threshold" and

"high_rate_threshold" should both be set to 500. To implement configuration adjustments, disable and then enable the plugin.

In case of an event storm, it is necessary to adjust the Event Policy settings such that General Events are non-alarmable and the TTL is set to zero, as illustrated in the following screenshot:

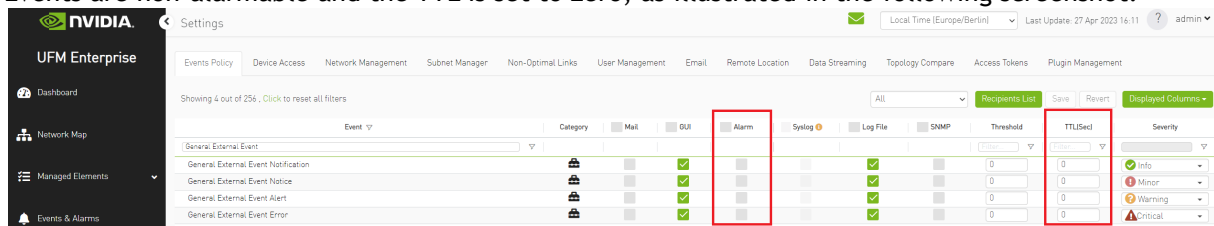

11.14.5 Other

Additional configurations are located in `"/opt/ufm/conf/plugins/snmp/snmp.conf"`. To implement configuration adjustments, disable and then enable the plugin. For instructions on modifying the appliance, please refer to the [UFM-SDN App CLI Guide](#).

Logs for the SNMP plugin are stored in `"/opt/ufm/logs/snmptrap.log"`. For guidance on accessing logs on the appliance, please refer to the [UFM-SDN App CLI Guide](#).

11.15 Packet Level Monitoring Collector (PMC) Plugin

11.15.1 Overview

The Packet Monitoring Collector/Controller plugin facilitates the configuration capture and display of a variety of events, enabling users to conduct real-time monitoring of network events. The PMC plugin is included in the plugins bundle, which can be downloaded from [NVIDIA's Licensing Portal](#).

Supported triggers are pFRN, Congestion, Fast Recovery, CQE and PHY Error Links.

Network events are stored as UFM events and are archived in files for later retrieval. Additionally, they can be observed through the PMC user interface. Events can be streamed externally via UFM REST API in the same way that UFM events are streamed. The REST APIs are described in the [UFM Enterprise REST API Guide](#).

11.15.1.1 pFRN

- pFRN Notifications - Enables/Disables mirroring on pFRN trigger for entire network or list of GUIDs

11.15.1.2 Fast Recovery

- Fast Recovery Notifications - Enables/Disables mirroring on Fast Recovery trigger for entire network or list of GUIDs
- Notifications Level - Specifies threshold for Fast Recovery mirroring. (Thresholds are configured in SM configuration)

11.15.1.3 PHY Error Links

- PHY Error Links Notifications - Enables/Disables mirroring on PHY Link Error trigger for entire network or list of GUIDs
- Specifies threshold for PHY Link Error mirroring. (Thresholds are configured in SM configuration)

11.15.1.4 CQE

- CQE Notifications - Enables/Disables mirroring on CQE Notifications trigger for entire network or list of GUIDs

11.15.1.5 Congestion

- Congestion Notifications - Enables/Disables mirroring on Congestion Notifications trigger for entire network or list of GUIDs
 - Mirrored packets (%) - Specifies the percent of congested packets to be mirrored.
 - High threshold - High threshold percentage for InfiniBand switch egress port queue size. Values are in the [1,1023] range.
 - Low threshold - Low threshold percentage for InfiniBand switch egress port queue size. Values are in the [1,1023] range.

When a packet enters an InfiniBand switch, its data is stored at an ingress port buffer. A pointer to the packet's data is inserted into the egress port's queue, from which the packet will be exiting the switch. At that point, the threshold given by this command line argument is compared to the egress queue data size. If the queue data size exceeds the threshold, a congestion event is reported. The threshold is given in percent of the ingress port size.

An egress port queue can point data coming from multiple ingress port buffers, therefore the threshold can be bigger than 100%.

11.15.2 Deployment

11.15.2.1 Installation

Load the image on the UFM server; either using the UFM GUI -> Settings -> Plugins Management tab, or by loading the image via the following command:

1. [Login to the UFM server terminal.](#)
2. [Run](#)

```
docker load -I <path_to_image>
```

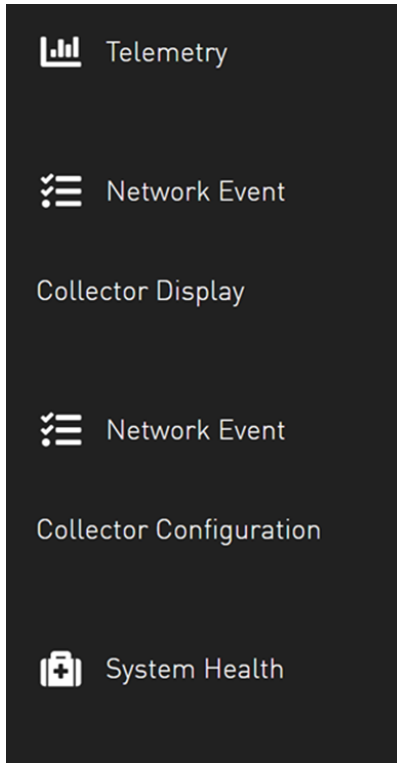

Upon completion of the plugin addition and subsequent refresh of the UFM GUI, the left navigation bar will display two new menu items. These two tabs can be observed in the following GUI screenshots

11.15.3 PMC UI

11.15.3.1 Network Event Collector Display

Network Event Collector Display

pFRN Events Congestion Events Fast Recovery Events CQE Events

Profile Time

Please wait...

Displayed Columns

timestamp	src guid	src lid	src desc	local qpn	dst lid	remote qpn	transport	syndrome
2024-01-02 11:20:13.607486	0x98039b03009fce86	1	smg-ib-svr065 mx5_0	72	6	224	RC	Remote Access Error

Viewing 1-1 of 1

11.15.3.2 Network Event Collector Configuration

Network Event Collector Configuration

Collectors

pFRN Notifications	<input type="text" value="on Entire Network"/>	<input type="button" value="Browse"/>
Fast Recovery Notifications	<input type="text" value="on Entire Network"/>	<input type="button" value="Browse"/>
Notification Level	<input type="text" value="Normal"/>	
PHY Error Links Notifications	<input type="text" value="on Entire Network"/>	<input type="button" value="Browse"/>
Notification Level	<input type="text" value="Normal"/>	
CQE Notifications	<input type="text" value="on Entire Network"/>	<input type="button" value="Browse"/>
Congestion Notifications	<input type="text" value="Disabled"/>	<input type="button" value="Browse"/>
Mirrored packets (%)	<input type="text" value="1"/>	
High threshold	<input type="text" value="75"/>	
Low threshold	<input type="text" value="50"/>	

General Options

enable adaptive routing	<input type="checkbox"/>
enable aggregation	<input checked="" type="checkbox"/>
enable autostart	<input checked="" type="checkbox"/>

11.16 PDR Deterministic Plugin

11.16.1 Overview

The PDR deterministic plugin, overseen by the UFM, is a docker container that isolates malfunctioning ports, and then reinstates the repaired links to their previous condition by lifting the isolation. The PDR plugin uses a specific algorithm to isolate ports, which is based on telemetry data from the UFM Telemetry. This data includes packet drop rate, BER counter values, link down counter, and port temperature. Any decisions made by the plugin will trigger an event in the UFM for tracking purposes.

The PDR plugin performs the following tasks:

1. Collects telemetry data using UFM Dynamic Telemetry
2. Identifies potential failures based on telemetry calculations and isolates them to avert any interruption to traffic flow
3. Maintains a record of maintenance procedures that can be executed to restore an isolated link
4. After performing the required maintenance, the system verifies if the ports can be de-isolated and restored to operational status (brought back online).

The plugin can simulate port isolation without actually executing it for the purpose of analyzing the algorithm's performance and decision-making process in order to make future adjustments. This behavior is achieved through the implementation of a "dry_run" flag that changes the plugin's behavior to solely record its port "isolation" decisions in the log, rather than invoking the port isolation API. All decisions will be recorded in the plugin's log.

11.16.2 Schematic Flow

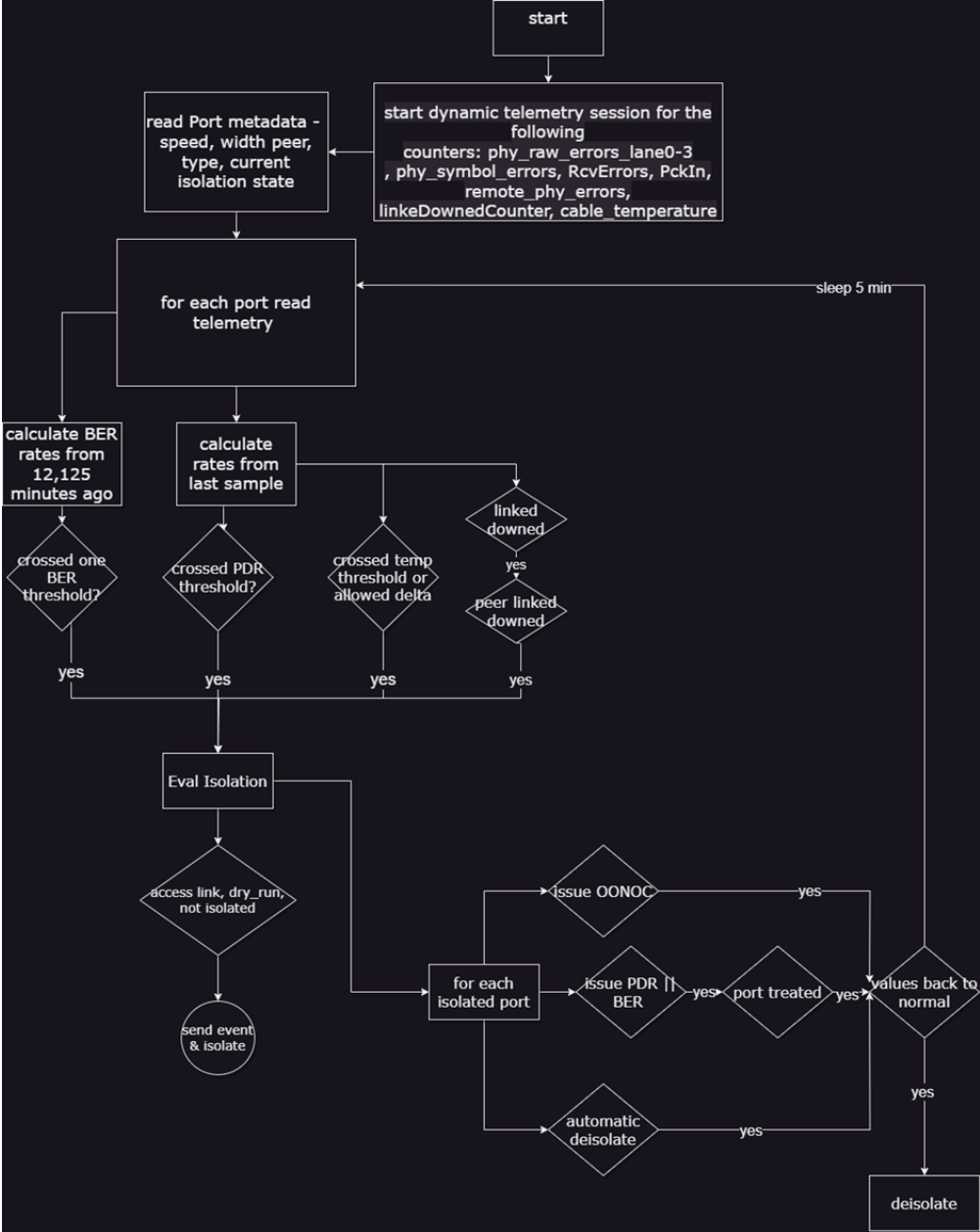

11.16.3 Deployment

To deploy the plugin, follow these steps:

1. Download the ufm-plugin-pdr_deterministic-image from the Docker Hub.
2. Load the downloaded image onto the UFM server. This can be done either by using the UFM GUI by navigating to the Settings -> Plugins Management tab or by loading the image via the following instructions:
 - a. Log in to the UFM server terminal.
 - b. Run:

```
docker load -i <path_to_image>
```

- c. After successfully loading the plugin image, the plugin should become visible in the plugin management table within the UFM GUI. To initiate the plugin's execution, simply right-click on the respective in the table.

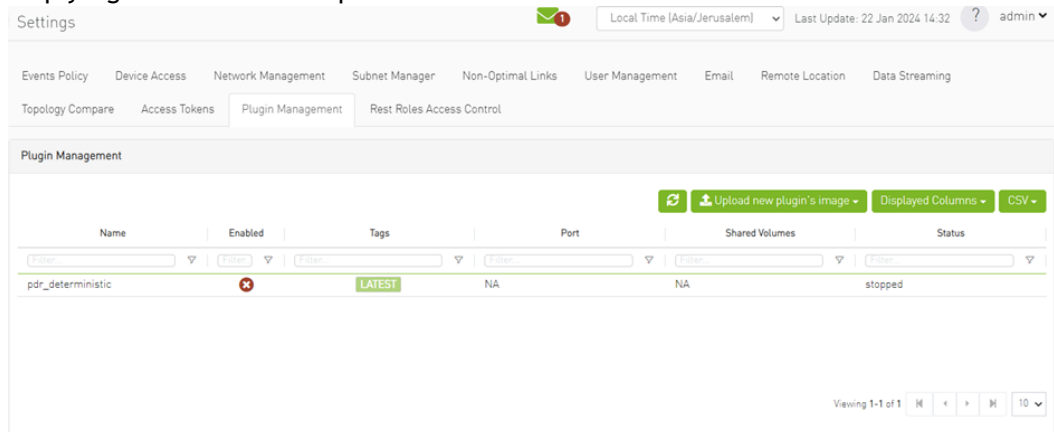

11.16.4 Isolation Decisions

11.16.4.1 NDR Link Validation Procedure

Verify ports that are in INIT, ARMED or ACTIVE states only. Track the SymbolErrorsExt of every such link for at least 120m. If polling period is Pm, need to keep $N=(125+Pm+1)/Pm$ samples. Also, two delta samples are computed: number of samples covering 12 minutes $S12m = (12 + Pm + 1)/Pm$ and $S125m = (125 + Pm + 1)/Pm$. $12m_thd = LinkBW_Gbps * 1e9 * 12 * 60 * 1e-14$ (2.88 for NDR) and $125m_thd = LinkBW_Gbps * 1e9 * 125 * 60 * 1e-15$ (3 for NDR).

Check the following conditions for every port in the given set:

1. If the $\Delta(LinkDownedCounterExt)$ port is > 0 and the $\Delta(LinkDownedCounterExt)$ remote port is > 0 , add it to the list of `bad_ports`. This condition should be ignored if the `--no_down_count` flag is provided.
2. If the $symbol_errors[now_idx] - symbol_errors[now_idx - S12m]$ is $> 12m_thd$, add the link to the list of `bad_ports`, and continue with next link.
3. If the $symbol_errors[now_idx] - symbol_errors[now_idx - S125m]$ is $> 125m_thd$, add the link to the list of `bad_ports`, continue with next linkPacket drop rate criteria

When packet drops due to the link health are detected, isolate the problematic link. To achieve this, a target packet_drop/packet_delivered ratio can be employed to include TX ports with a

receiver exceeding this threshold in the list of `bad_ports`. However, the drawback of this method is that such links may fluctuate between bad/good state since their BER may be normal. Therefore, it is advisable to track their statistics over time and refrain from reintegrating them after their second or third de-isolation.

11.16.4.2 Return to Service

Continuously monitoring the collection of `bad_ports`, the plugin persistently assess their Bit Error Rate (BER) and determines their reintegration when they successfully pass the 126m test without errors.

11.16.4.3 Configuration

The following parameters are configurable via the plugin's configuration file.
(`pdr_deterministic.conf`)

Name	Description	Default Value
<code>INTERVAL</code>	Interval for requesting telemetry counters, in seconds.	300
<code>MAX_NUM_ISOLATE</code>	Maximum ports to be isolated. $\max(\text{MAX_NUM_ISOLATE}, 0.5\% * \text{fabric_size})$	10
<code>TMAX</code>	Maximum temperature threshold	70 (Celsius)
<code>D_TMAX</code>	Maximum allowed Temperature Delta	10
<code>MAX_PDR</code>	Maximum allowed packet drop rate	1e-12
<code>CONFIGURED_BER_CHECK</code>	If set to true, the plugin will isolate based on BER calculations	True
<code>CONFIGURED_TEMP_CHECK</code>	If set to true, the plugin will isolate based on temperature measurements	True
<code>LINK_DOWN_ISOLATION</code>	If set to true, the plugin will isolate based on LinkDownedCounterExt measurements	False
<code>SWITCH_TO_HOST_ISOLATION</code>	If set to true, the plugin will isolate ports connected via access link	False
<code>DRY_RUN</code>	Isolation decisions will be only logged and will not take effect	False
<code>DEISOLATE_CONSIDER_TIME</code>	Consideration time for port de-isolation (in minutes)	5
<code>DO_DEISOLATION</code>	If set to false, the plugin will not perform de-isolation	True
<code>DYNAMIC_WAIT_TIME</code>	Seconds to wait for the dynamic telemetry session to respond	30

11.16.4.4 Calculating BER Counters

For calculating BER counters, the plugin extracts the maximum window it needs to wait for calculating the BER value, using the following formula:

$$seconds = \frac{max_BER_target^{-1}}{min_port_rate}$$

Example:

	Rate	BER Target	Minimum Bits	Minimum Time in Seconds	In Minutes
HDR	2.00E+11	1.00E-12	1.00E+12	5	0.083333
HDR	2.00E+11	1.00E-13	1.00E+13	50	0.833333
HDR	2.00E+11	1.00E-14	1.00E+14	500	8.333333
HDR	2.00E+11	1.00E-16	1.00E+16	50000	833.3333

BER counters are calculated with the following formula:

$$BER = \frac{error\ bits_i - error\ bits_{i-1}}{total\ bits_i - total\ bits_{i-1}} = \frac{error\ bits_i - error\ bits_{i-1}}{Link\ data\ rate * (time_i - time_{i-1})}$$

11.16.4.5 Ports Exclusion List

You can designate specific ports to be excluded from PDR analysis, isolation, or de-isolation for an indefinite or limited period. Already excluded ports can also be removed from this list.

Ports are added to or removed from the exclusion list via the PDR plugin's REST API.

To add ports to the exclusion list (to be excluded from analysis), run:

```
curl -k -i -u <user:password> -X PUT 'https://<host_ip>/ufmRest/plugin/pdr_deterministic/excluded' -d '[<formatted_ports_list>]' -H "Content-Type: application/json"
```

Optionally, you can specify a TTL (time to live in the exclusion list) following the port after the comma. If zero or not specified, the port is excluded. For example:

```
-d '[["9c0591030085ac80_45"],["9c0591030085ac80_46",300]]'
```

To remove ports from the exclusion list:

```
curl -k -i -u <user:password> -X DELETE 'https://<host_ip>/ufmRest/plugin/pdr_deterministic/excluded' -d '[<comma_separated_port_names>]' -H "Content-Type: application/json"
```

Example:

```
-d '["9c0591030085ac80_45","9c0591030085ac80_46"]'
```

To retrieve ports and their remaining exclusion times from the exclusion list:

```
curl -k -i -u <user:password> -X GET 'https://<host_ip>/ufmRest/plugin/pdr_deterministic/excluded'
```

11.17 GNMI-Telemetry Plugin

The GNMI Telemetry Plugin is a server that uses the gNMI protocol to stream data from UFM telemetry. Users can select the data to stream, specify intervals, and choose to include only deltas (on-change mode).

The server supports three functions: Capability, Get and Subscribe.

Data Streaming: The streamed data is delivered in CSV format. Headers are provided in the first message and included in subsequent messages. Data is presented in hex format to conserve space for unchanged data. Values are displayed as an array of strings, each representing a unique identifier (GUID) and port. Depending on the mode, values may have missing rows if there are no changes in the GUID and port.

Metadata Streaming: The plugin can stream UFM's metadata, providing an inventory of it. For convenience, examples use the gNMIc client, but any gNMI client can be used.

Configuration and Polling Intervals: The polling intervals for each server cache are configurable with the following defaults:

- Telemetry: every 5 minutes
- Inventory: every minute
- Events: every minute
- Switch rank: every 6 hours

The service supports telemetry from switch-level data (fset) and port-level data (xcset), querying `low_freq_debug xcset` by default. Multiple telemetries can be polled simultaneously.

Data Sharding: The service supports sharding the cache data on request, allowing many clients to request the same data while each receiving a different part.

11.17.1 Deployment

To deploy the plugin with UFM (SA or HA):

1. Install the latest version of UFM.
2. Run UFM with `/etc/init.d/ufmd start`.
3. Pull the plugin image from the Docker Hub.
4. Run `/opt/ufm/scripts/manage_ufm_plugins.sh add -p gnmi-telemetry -t <version>` to enable the plugin, or use the UFM UI to add the plugin via Setting → Plugin Management → Right Click on GNMI-telemetry → Add → select version → Add.
5. Check that the plugin is running with `docker ps`.
6. If the gNMI default port is unavailable, change the config file `gnmi-telemetry.env` and restart the plugin.

11.17.2 Authentication

The server's authentication is determined by the gNMI protocol. Two configurable items require authentication: the UFM Telemetry URL and the UFM inventory IP.

- Authentication is not necessary for the UFM telemetry URL. Therefore, only the telemetry URL is required.
- The inventory is sourced from the UFM of the local host, but can be changed to a different machine in the config file. To do so, token access to that machine is necessary.

11.17.3 Secure Server

The server can be secured using certificates. To secure the server, set the "secure_mode_enabled" flag to "true" in the configuration (default is true). Upon initialization, the gNMI server retrieves UFM certificates from the `/opt/ufm/conf/webClient` folder. The certificate folder can be changed by modifying the shared volume.

The server requires client-call certificates, granting access only if client certificates match its own. The gNMI server periodically checks its certificates for updates, ensuring they remain up-to-date. The client certification naming convention must align with the DNS name (SAN) as the UFM.

11.17.4 Supported API Requests

The service supports the following requests:

- **Capability:** Describes the YANG files the service supports (UFM telemetry).
- **Get:** Requires legal paths; receives the cache data from the service.
- **Subscribe:** Requires legal paths and an interval; receives cache data at the specified interval. The first message contains headers extracted from the path, and subsequent messages include only the headersID. In on-change subscribe mode, a heartbeat interval is provided instead of an interval. During the heartbeat interval, if no data changes, no notification is sent; A full notification message, similar to the first message, is sent. If some data changes a notification of the change is sent; No heart message is send.

11.17.4.1 Capability Request

The capability request provides information about the YANG files that the server supports, including their versions. This request can be fulfilled without requiring a connection to the telemetry or inventory.

Example:

```
gnmic -a localhost:9339 capability
```

Example Response:

```
gNMI version: 1.2.11
supported models:
- nvidia-ib-amber, Nvidia IB, 1.0.0
- nvidia-ib-amber-ext, Nvidia IB, 1.0.0
- nvidia-ib-amber-inventory-counters, Nvidia IB, 1.0.0
- nvidia-ib-amber-port-counters, Nvidia IB, 1.0.0
supported encodings:
- JSON
- JSON_IETF
```

11.17.4.2 Supported Paths

11.17.4.2.1 Telemetry Request Path Construction

To construct a path for a telemetry request, follow these steps:

1. Begin with "nvidia/ib".
2. Specify sharding if desired. For example, to partition the data into 10 pieces and take the second partition, use 2/10.
3. Specify the `node_guid` to select, using an asterisk (*) to select all nodes.
4. Specify the desired ports for the selected nodes, using an asterisk (*) to select all ports.
5. Select "amber" for amBER telemetry.
6. Specify the desired counters group. If unknown, this step can be skipped.
7. Specify the counter, using an asterisk (*) to select all the counters in the cache. If a counters group is used, it will return all counters in the specified group.

11.17.4.2.2 Other Information Requests (Events, Inventory)

1. Begin with "nvidia/ib".
2. Specify `inventory` or `events`.

11.17.4.2.3 Switch Rank Information Path Construction

To construct a path for switch rank information, follow these steps:

1. Begin with "nvidia/ib".
2. Specify the `node_guid` to select, using an asterisk (*) to select all nodes.
3. Select "amber" for amBER telemetry.
4. Use `Switch_rank` as the counter name.

11.17.4.2.4 Additional Configurations

Name	Description	Default
<code>grpc_port</code>	The port that the service uses for the gNMI protocol	9339
<code>cpu_list</code>	The CPU cores that the server is allowed to use	3
<code>include_port_sharding</code>	Includes the ports in the sharding. Ports of the node may not be in the same shard	false
<code>filtered_columns</code>	Specifies which counters to ignore when querying the telemetry	<code>port_guid</code>
<code>ufm_ip</code>	If querying events and inventory from a different UFM instance, provide the IP of that host machine and a UFM token for remote UFM	127.0.0.1
<code>ufm_access_token</code>	Required if the <code>ufm_ip</code> is not local	

11.17.4.3 Telemetry Messages - Data Format

Telemetry messages consist of two key components: Headers and Values, both representing telemetry data in a CSV format.

- Headers: Initially provided in a full mode, but transition to a string hash format after the second message when using a subscribe request to reduce message size.
- Values: Each value begins with a timestamp, followed by the `node_guid` and port number, and then the counter value in the same order as the headers. If a counter is not present for a node, it will be empty in the message.

In on-change subscribe messages, only nodes with changes and their corresponding modified values are included. All other counters for that node will remain empty.

Example:

```
gnmic -a localhost:9339 --insecure sub --path nvidia/ib/guid[guid=*/port[port_number=*/amber/port_counters/hist0
--path nvidia/ib/guid[guid=*/port[port_number=*/amber/port_counters/hist1 -i 30s
[{"source": "localhost:9339",
 "subscription-name": "default-1690282472",
 "timestamp": 1690282475124352063,
 "time": "2023-07-25T13:54:35.124352063+03:00",
 "updates": [{"Path": "nvidia/ib/amber/reply/sample", "values": { "nvidia/ib/amber/reply/sample": {
 "Headers": "timestamp,guid,port,hist0,hist1",
 "HeaderID": "5246201354",
 "Values": ["240771222771818,0x8168793592c6a790,1,,2",
 "240771222771818,0x47a67159c915493f,1,1,2",
 ...
 "240771222771818,0x667203ac69f3f2bf,1,2,",
 "240771222771818,0x113cd807bfed3853,1,0,"
 ]}}}]}
```

The second message on the headers will be set to hash values.

11.17.5 Get Request

The Get request retrieves data at a specified path. If the telemetry is devoid of information, the server will respond with an empty response. Otherwise, it will respond with counters it can locate.

Example:

```
gnmic -a localhost:9339 --insecure get --path nvidia/ib/guid[guid=0x5255456]/port[port_number=2]/amber/
port_counters/hist0
```

The request retrieves data from `node_guid` `0x5255456`, specifically in port number 2, with the request counter set to `hist0`.

Example 2:

```
gnmic -a localhost:9339 --insecure get --path nvidia/ib/guid[guid=*/port[port_number=*/amber/port_counters/hist0
```

The request retrieves the data from all the ports and the `node_guids`, with the request counter set to `hist0`.

Example3:

```
gnmic -a localhost:9339 --insecure get --path nvidia/ib/guid[guid=0x5255456]/port[port_number=2]/amber/*
```

The request retrieves the data from node_guid `0x5255456` , port 2, with the request counters set to "all".

Example for multi path:

```
gnmic -a localhost:9339 --insecure get nvidia/ib/guid[guid=*/port[port_number=*/amber/
CableInfo.transmitter_technology --path nvidia/ib/guid[guid=*/port[port_number=*/amber/sel_gctrln_en_5_lane0 --
path nvidia/ib/guid[guid=*/port[port_number=*/amber/num_plls_7nm --path nvidia/ib/guid[guid=*/
port[port_number=*/amber/rcal_fsm_done --path nvidia/ib/guid[guid=*/port[port_number=*/amber/
LinkErrorRecoveryCounterExtended --path nvidia/ib/guid[guid=*/port[port_number=*/amber/sel_enc2_ib0_lane2 --path
nvidia/ib/guid[guid=*/port[port_number=*/amber/lockdet_err_cnt_unlocked_sticky
```

Response Example:

```
{
  "source": "localhost:9339",
  "timestamp": 1719232374915165166,
  "time": "2024-06-24T15:32:54.915165166+03:00",
  "updates": [
    {
      "Path": "nvidia/ib/amber/reply",
      "values": {
        "nvidia/ib/amber/reply": {
          "Headers": ["timestamp", "Node_GUID", "Port_Number", "CableInfo.transmitter_technology", "sel_gctrln_en_5_
lane0", "num_plls_7nm", "rcal_fsm_done", "LinkErrorRecoveryCounterExtended", "sel_enc2_ib0_lane2", "lockdet_err_cnt_unloc
ked_sticky"],
          "Values": [
            "1719232345757948,0x91f87bf42deb3e03,1,5091,7826,6290,8615,4247,8586,6214",
            "1719232345757948,0x7b8c2e08907250ce,1,2891,3293,5774,4398,3681,3548,7408",
            "1719232345757948,0x48b60e6f3670eaca,1,9477,3847,1184,5527,4783,2102,8192",
            "1719232345757948,0xabccdad7f8a3eda6,1,7976,6143,8257,3770,6166,6690,2835",
            "1719232345757948,0x6d9ec4bb5fa45736,1,9051,2982,7145,3604,9256,1061,2638",
            "1719232345757948,0x028cf9e0f9ed7c32,1,5623,7483,2263,2265,6890,4875,5564",
            "1719232345757948,0x92a984c1a491b72a,1,6732,7795,6411,8569,3370,705,5536",
            "1719232345757948,0x8b4b404acd2f34da,1,7610,7128,10064,1880,4834,3411,6724",
            "1719232345757948,0x20f92ed58991d56c,1,6805,1632,5407,2038,1865,7279,8350",
            "1719232345757948,0x1dac004a426bb5f5,1,8351,5757,7925,6181,3260,3081,1554"
          ]
        }
      }
    }
  ]
}
```

11.17.5.1 Subscribe Stream Request

The Subscribe request, similar to the get request, provides data from the specified path. When the telemetry is empty, the server responds with an empty result. If data is available, the server responds with the retrieved counters. The stream delivers information at the specified interval. If no interval is specified, the server transmits the information at the default server rate, which is configurable and defaults to 10s.

Example:

```
gnmic -a localhost:9339 --insecure sub --path nvidia/ib/guid[guid=0x5255456]/port[port_number=2]/amber/
port_counters/hist0 -i 30s
```

This request retrieves data from the node_guid `0x5255456` , port 2, where the request counter is hist0, and the interval is configured for 30 seconds. If the user wishes to test the stream, the stream mode can be configured to "once," and following a single response, the stream will be stopped.

Example:

```
gnmic -a localhost:9339 --insecure sub --path nvidia/ib/guid[guid=0x5255456]/port[port_number=2]/amber/
port_counters/hist0 -i 30s --mode once
```

This request retrieves the data from node_guid `0x5255456` , port 2, where the request counter is hist0. The stream shuts down after one response, similar to a Get request.

Example:

```
gnmic -a localhost:9339 --insecure sub --path nvidia/ib/guid[guid=*]/port[port_number=*]/amber/* -i 10s
```

The server responds for the first two notifications, as follows:

```
{
  "source": "localhost:9339",
  "subscription-name": "default-1719233128",
  "timestamp": 1719233128171946518,
  "time": "2024-06-24T15:45:28.171946518+03:00",
  "updates": [{
    "Path": "nvidia/ib/amber/reply/sample",
    "values": {
      "nvidia/ib/amber/reply/sample": {
        "HeaderID": "970426048",
        "Headers": ["timestamp", "Node_GUID", "Port_Number", "Counter1", "Counter2", "Counter3", "Counter4", "Counter5", "Counter6", "Counter7"],
        "Values": [
          "1719232345757948,0x91f87bf42deb3e03,1,5091,7826,6290,8615,4247,8586,6214",
          "1719232345757948,0x7b8c2e08907250ce,1,2891,3293,5774,4398,3681,3548,7408",
          "1719232345757948,0x1dac004a426bb5f5,1,8351,5757,7925,6181,3260,3081,1554",
          "1719232345757948,0x48b60e6f3670eaca,1,9477,3847,1184,5527,4783,2102,8192",
          "1719232345757948,0xabccdad7f8a3eda6,1,7976,6143,8257,3770,6166,6690,2835",
          "1719232345757948,0x6d9ec4bb5fa45736,1,9051,2982,7145,3604,9256,1061,2638",
          "1719232345757948,0x028cf9e0f9ed7c32,1,5623,7483,2263,2265,6890,4875,5564",
          "1719232345757948,0x92a984c1a491b72a,1,6732,7795,6411,8569,3370,705,5536",
          "1719232345757948,0x8b4b404acd2f34da,1,7610,7128,10064,1880,4834,3411,6724",
          "1719232345757948,0x20f92ed58991d56c,1,6805,1632,5407,2038,1865,7279,8350"
        ]
      }
    }
  ]
}

{
  "source": "localhost:9339",
  "subscription-name": "default-1719233128",
  "timestamp": 1719233138173907825,
  "time": "2024-06-24T15:45:38.173907825+03:00",
  "updates": [{
    "Path": "nvidia/ib/amber/reply/sample",
    "values": {
      "nvidia/ib/amber/reply/sample": {
        "HeaderID": "970426048",
        "Values": [
          "1719232345757948,0x20f92ed58991d56c,1,6805,1632,5407,2038,1865,7279,8350",
          "1719232345757948,0x1dac004a426bb5f5,1,8351,5757,7925,6181,3260,3081,1554",
          "1719232345757948,0x48b60e6f3670eaca,1,9477,3847,1184,5527,4783,2102,8192",
          "1719232345757948,0xabccdad7f8a3eda6,1,7976,6143,8257,3770,6166,6690,2835",
          "1719232345757948,0x6d9ec4bb5fa45736,1,9051,2982,7145,3604,9256,1061,2638",
          "1719232345757948,0x028cf9e0f9ed7c32,1,5623,7483,2263,2265,6890,4875,5564",
          "1719232345757948,0x92a984c1a491b72a,1,6732,7795,6411,8569,3370,705,5536",
          "1719232345757948,0x8b4b404acd2f34da,1,7610,7128,10064,1880,4834,3411,6724",
          "1719232345757948,0x91f87bf42deb3e03,1,5091,7826,6290,8615,4247,8586,6214",
          "1719232345757948,0x7b8c2e08907250ce,1,2891,3293,5774,4398,3681,3548,7408"
        ]
      }
    }
  ]
}
```

11.17.5.2 Subscribe On-Change Request

The subscribe on-change request, similar to the standard subscribe request, provides data from the specified path. If the telemetry lacks data, the server responds with an empty result. When data is available, the server responds with the located counters. The stream delivers information at the specified interval, but only if there is new information to transmit. Otherwise, it waits for the next interval to check for updates. The path construction follows the same pattern as the get request and includes inventory and event paths.

Only updated data will be included in the response, with all other parts remaining empty but retaining the specified format. Similarly, only the nodes that have been updated will be included in the response.

Example:

```
gnmic -a localhost:9339 --insecure sub --path nvidia/ib/guid[guid=0x5255456]/port[port_number=2]/amber/port_counters/hist0 --stream-mode on-change --heartbeat-interval 1m
```

This request retrieves data from node_guid `0x5255456`, port 2, with the request counters set to `hist0`. It periodically checks for changes every minute, and when changes are detected, it promptly sends the updated values.

Example:

```
gnmic -a localhost:9339 --insecure sub --path nvidia/ib/guid[guid=*]/port[port_number=*]/amber/port_counters/* --stream-mode on-change --heartbeat-interval 1m
```

This request involves all nodes and ports, aiming to retrieve all counters from the telemetry. It periodically checks for changes every minute, and when changes are detected, it promptly sends the updated values.

The below is an example of the response to a particular GUID, which represents an on-change request for a few counters. However, only specific counters have been updated, those who have not updated have a value of 0. Because the flag `include_old_data_on_change` default is true

```
1706532307824,0x0002c903007e5220,1,0,0,0,41447490564,617155163,41423305825,617155163,24184739,17,0,0,0,0,0
```

The same example with the flag set to true will give this:

```
1706532307824,0x0002c903007e5220,1,,,,,41447490564,617155163,41423305825,617155163,24184739,17,,,,,
```

Only the values that have changed return while the others are empty values. To get this format of data, one need to change the `include_old_data_on_change` in the config file to false.

Example:

```
gnmic -a localhost:9339 --insecure sub --path nvidia/ib/guid[guid=*]/port[port_number=*]/amber/* --stream-mode on-change --heartbeat-interval 24h
```

The server responds for the first 2 notifications are the following (where `include_old_data_on_change` is true), one can see the last two columns have not changed but still return the data before, the second message was send due to some rows have changed, those rows

```
{
  "source": "localhost:9339",
  "subscription-name": "default-1719236764",
  "timestamp": 1719236764654659517,
  "time": "2024-06-24T16:46:04.654659517+03:00",
  "updates": [
    {
      "Path": "nvidia/ib/amber/reply/onchange",
      "values": {
        "nvidia/ib/amber/reply/onchange": {
          "HeaderID": "912200528",
          "Headers": ["timestamp", "Node_GUID", "Port_Number", "Counter1", "Counter2", "Counter3", "Counter4", "Counter5", "Counter6", "Counter7"],
          "Values": [
            "1719236753818594,0x7e680fb8f81a1950,1,100531,107250,100999,107455,109258,3716,5329",
            "1719236753818594,0x0176438fe4ee507c,1,104269,108884,104887,108502,105366,4540,6673",
            "1719236753818594,0x2e36224302959e79,1,101228,100555,105616,102767,108899,87,9953",
            "1719236753818594,0x8e62a55d7571a9b8,1,100684,108124,106670,102400,106689,2910,4203",
            "1719236753818594,0x0be75a9e97016f5e,1,102227,102735,108903,103547,108705,2629,1830",
            "1719236753818594,0x8307bfad0672adbd,1,106033,103906,106185,107450,105736,2567,6914",
            "1719236753818594,0x2cbe66ec0b1af84c,1,105958,106959,100349,107704,105073,8330,4962",
            "1719236753818594,0x6b6da39a9ec4bbfc,1,104340,106752,109134,103796,103500,7136,3493",
            "1719236753818594,0x6d122dbdd99cfeb60,1,104941,107630,104190,105392,109582,5480,7934",
            "1719236753818594,0xfeed4bd9cd3b7f325,1,102416,100164,106731,102033,103807,3048,6316"
          ]
        }
      }
    }
  ]
}

{
  "source": "localhost:9339",
  "subscription-name": "default-1719236764",
  "timestamp": 1719237054620929561,
  "time": "2024-06-24T16:50:54.620929561+03:00",
  "updates": [
    {
      "Path": "nvidia/ib/amber/reply/onchange",
      "values": {
        "nvidia/ib/amber/reply/onchange": {
          "HeaderID": "912200528",
          "Values": [

```

```

"1719237054172043,0xeed4bd9cd3b7f325,1,117416,115164,121731,117033,118807,3048,6316",
"1719237054172043,0x2e36224302959e79,1,116228,115555,120616,117767,123899,87,9953",
"1719237054172043,0x8e62a55d7571a9b8,1,115684,123124,121670,117400,121689,2910,4203",
"1719237054172043,0x7e680fb8f81a1950,1,115531,122250,115999,122455,124258,3716,5329",
"1719237054172043,0x0176438fe4ee507c,1,119269,123884,119887,123502,120366,4540,6673"
}}}}

```

11.17.6 Inventory Requests

Inventory messages are conveyed in separate updates, presenting the inventory details of the UFM associated with the provided IP. These messages display comprehensive information, including the total count of various components within the UFM, such as switches, routers, servers, and more, along with details about active ports and the total number of ports, including disabled ones. Moreover, inventory requests include the size of the telemetry, which is not always the same as the active ports. In cases where the plugin is unable to establish contact with the UFM, it will revert to using default values defined in the configuration file. It is worth noting that the path for inventory requests differs from the conventional path structure, as they do not rely on specific nodes or ports. Consequently, inventory requests are initiated after `"nvidia/ib."`

Example:

```
gnmic -a localhost:9339 --insecure get -path nvidia/ib/inventory/*
```

Response:

```

[ {
  "source": "localhost:9339",
  "timestamp": 1698824237536878067,
  "time": "2023-11-01T09:37:17.536878067+02:00",
  "updates": [ {
    "Path": "nvidia/ib/inventory",
    "values": {
      "nvidia/ib/inventory": {
        "ActivePorts": 4, "Cables": 2, "Gateways": 0, "HCAs": 2, "Routers": 0, "Servers": 2, "Switches": 1, "TotalPorts": 38, "TelemetrySize": 4, "timestamp": 1698824211535069000}
      }
    }
  ]
} ]

```

11.17.7 Events Requests

Events messages are provided in separate updates, offering insights into the events occurring within the UFM associated with the specified IP. Given that the event metadata remains consistent, even when numerous events are part of a request, the message format adopts a CSV-like structure. The Headers section contains essential metadata regarding UFM events, while the Values section contains the raw event data. Users can subscribe to these events with the on-change feature enabled, receiving only the events triggered within the subscription interval. Notably, the path structure for event requests differs from the typical node or port-based structure and is requested after `"nvidia/ib."`

Example:

```
gnmic -a localhost:9339 --insecure get -path nvidia/ib/events/*
```

Response:

```

[ {
  "source": "localhost:9339",
  "timestamp": 1698824809647515575,
  "time": "2023-11-01T09:46:49.647515575+02:00",
  "updates": [ {
    "Path": "nvidia/ib/events",

```

```

    "values": {
      "nvidia/ib/events": {
        "Headers": [ "id", "object_name", "write_to_syslog", "description", "type", "event_type", "severity", "timesta
mp", "counter", "category", "object_path", "name"],
        "Values": [
          "7718,Grid,false,Disk space usage in /opt/ufm/files/log is above the threshold of
90.0%,Grid,525,Critical,2023-11-01 07:25:54,N/A,Maintenance,Grid,Disk utilization threshold reached",
          "7717,Grid,false,Disk space usage in /opt/ufm/files/log is above the threshold of
90.0%,Grid,525,Critical,2023-11-01 07:24:54,N/A,Maintenance,Grid,Disk utilization threshold reached",
          "7716,Grid,false,Disk space usage in /opt/ufm/files/log is above the threshold of
90.0%,Grid,525,Critical,2023-11-01 07:23:54,N/A,Maintenance,Grid,Disk utilization threshold reached",
          ...
          "7491,ec0d9a0300d42e54,false,Mcast group is deleted: ff12601bffff0000,
00000002,Computer,67,Info,2023-10-31 06:39:21,N/A,Fabric Notification,default / Computer: r-ufm59,MCast Group
Deleted"]
        ]}}}}]
}]]]]]

```

11.17.8 Switch Rank Requests

Switch rank updates are conveyed in separate messages, presenting the rank of the switches in the UFM. This data is derived from a file in the UFM and is updated by the server every 6 hours by default. The `switch_rank` counter is associated only with switch-level data, so there is no need to specify a port in the path. However, this counter is not connected to the telemetry cache of switch-level data. Note that if the `ufm_ip` is changed, the `switch_rank` information will not be available.

Example:

```

gnmic -a localhost:9339 --insecure get --path nvidia/ib/guid[guid=*]/amber/switch_rank

Respond for example:

{
  "source": "localhost:9339",
  "timestamp": 1719296207323383222,
  "time": "2024-06-25T09:16:47.323383222+03:00",
  "updates": [
    {
      "Path": "nvidia/ib/guid[guid=*]/amber/amber/switch_rank",
      "values": {
        "nvidia/ib/guid/amber/amber/switch_rank": {
          "Headers": "Timestamp,Node_GUID,switch_rank",
          "Values": [
            "1719296205612,0x0002c903007e5220,0"
          ]}}}}]
}]]]]]

```

11.18 UFM Telemetry Manager (UTM) Plugin

11.18.1 Overview

Managed telemetry is a mode of high availability and improved performance of UFM Telemetry processes.

Governed by UFM Telemetry Manager (UTM) several UFM Telemetry Instances (TIs) run on one or more machines, each collecting a subset of the cluster fabric.

UTM manages the following aspects:

- monitoring of TI states: down, initializing, running, paused
- TI management commands: add, remove, pause, start, restart
- partitioning of fabric based on TIs health and fabric changes
- assigning fabric segments to TIs
- telemetry coverage check of a cluster

The UFM Telemetry Manager (UTM) Plugin facilitates managed telemetry in high availability mode, enhancing the performance of UFM Telemetry operations.

Under the governance of UFM Telemetry Manager (UTM), multiple UFM Telemetry Instances (TIs) are executed on one or more machines, with each TI responsible for collecting a specific portion of the cluster fabric.

Key functionalities managed by UTM include:

- Monitoring TI statuses: down, initializing, running, paused
- Execution of TI management commands: add, remove, pause, start, restart
- Fabric partitioning based on TI health and fabric changes
- Assigning fabric segments to TIs
- Verification of telemetry coverage across the cluster

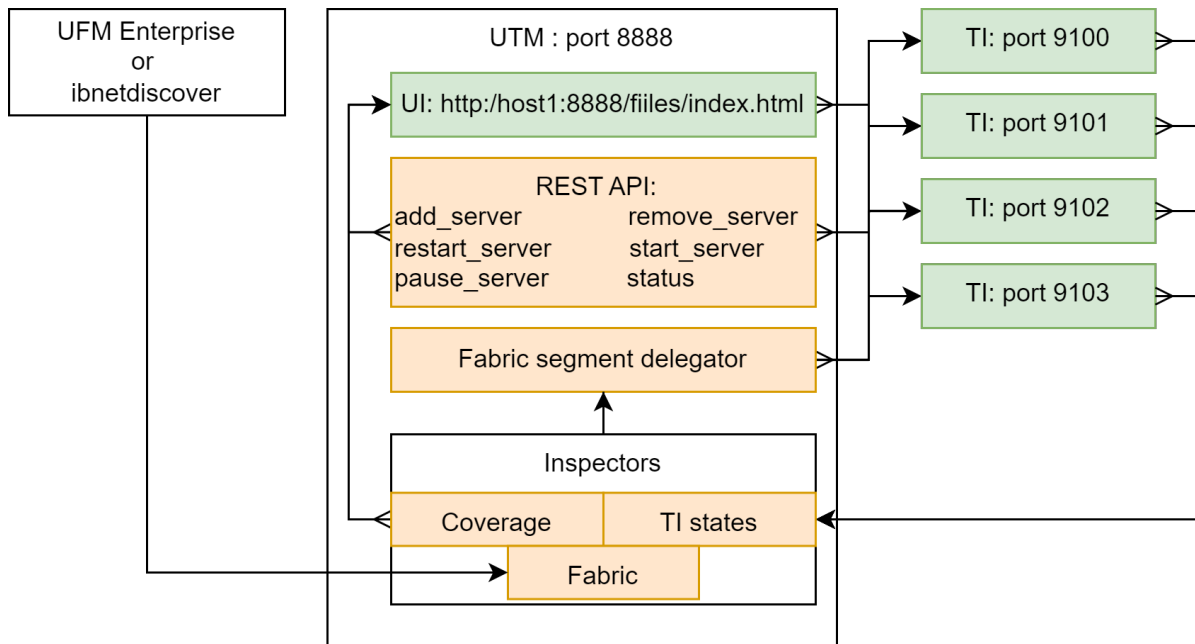

11.18.2 Deployment

As a first step, get the UTM image:

Get UTM image

```
docker pull mellanox/ufm-plugin-utm
```

The UTM plugin is designed to operate either as a UFM plugin or in standalone mode.

In both setups, it is advisable to utilize UTM deployment scripts. These scripts streamline the process by enabling the deployment or cleanup of the entire setup with just a single command. This includes UTM, host TIs, and preparation of the Switch Telemetry image.

11.18.2.1 UTM Deployment Scripts

Get deployment scripts and examples by mounting the local folder `UTM_DEPLOYMENT_SCRIPTS` (/tmp/utm_deployment_scripts in this example) and running `get_deployment_scripts.sh` :

Get UTM deployment scripts

```
$ export UTM_DEPLOYMENT_SCRIPTS=/tmp/utm_deployment_scripts
$ docker run -v "$UTM_DEPLOYMENT_SCRIPTS:/deployment_scripts" --rm --name utm-deployment-scripts -ti mellanox/ufm-plugin-utm:latest /bin/sh /get_deployment_scripts.sh
```

The content of the script folder consists of:

- **Examples** - Contains run/stop scripts for both standalone and UFM plugin modes. Each example script is an example of actual deployment script usage.
- **hostlist.txt** - Specifies the hosts, ports, and HCAs for TIs to be deployed
- **Scripts** - Contains actual deployment scripts. Entry-point script `deploy_managed_telemetry.sh` triggers the rest two scripts, depending on input arguments.

deployment scripts folder

```
$ cd $UTM_DEPLOYMENT_SCRIPTS
$ tree
.
├── examples
│   ├── run_standalone.sh
│   ├── run_with_plugin.sh
│   ├── stop_standalone.sh
│   └── stop_with_plugin.sh
├── hostlist.txt
├── README.md
└── scripts
    ├── deploy_bringup.sh
    ├── deploy_managed_telemetry.sh
    └── deploy_ufm_telemetry.sh
```

All example/deployment scripts should run from the `UTM_DEPLOYMENT_SCRIPTS` folder.

11.18.2.1.1 Hostlist File

Please note the following:

- The `hostlist.txt` file should be set before running any script.
- The hostname and port will be used for communication and HCA for telemetry collection.
- UTM only supports a single fabric for managed TIs, even if different HCAs on the same machine are connected to different fabrics.
- Both local and remote hosts are supported for TI deployments.

deployment help

```
$ cat hostlist.txt

# List lines in the following format:
# host:port:hca
#
# where:
# - host is IP or hostname. Use localhost or 127.0.0.1 for local deployment
```

```
# - port to run telemetry on.
# - hca is the target host device from which telemetry collects. Run `ssh $host ibstat`
#   to find the active device on the target host.

localhost:8123:mlx5_0
localhost:8124:mlx5_0
```

11.18.2.1.2 Main Deployment Script

For a more customizable setup beyond what the example scripts offer, users have the option to manually run `./scripts/deploy_managed_telemetry.sh`. This primary deployment script can deploy multiple TIs and optionally UTM as well.

Use `deploy_managed_telemetry.sh --help` to get help.

deployment help

```
./deploy_managed_telemetry.sh --help
./deploy_managed_telemetry.sh options:      mandatory:

mandatory:
  --hostlist-file=      Path to a file that lists hostname:port:hca lines
mandatory run options (use only one at the same time):
  -r, --run             Deploy and run managed telemetry setup
  -s, --stop           Stop all processes and cleanup
mandatory telemetry deployment options (use only one at the same time):
  -t, --ufmt-image=    UFM telemetry docker image or tgz/tar.gz-image
or:
  --bringup-package=   Bringup tar.gz package
optional:
  -m, --utm-image=     UTM docker image or tgz/tar.gz-image. Runs UTM only if it is set. Configures UTM
according hostlist file
  --utm-as-plugin=     if UTM runs as a plugin, set this flag
  -d, --data-root=    Root directory for run data | Default: '/tmp/managed_telemetry/'
  --switch-telem-image= Switch telemetry image (tar.gz-file or docker image). UTM will be able to deploy it
to managed switches if set
  --common-data-dir=   Common data folder for TIs
-h, --help            Print this message
```

11.18.2.2 UFM Plugin Mode

1. Upload the UTM Docker image to the Docker registry on the machine running UFM Enterprise.
2. Navigate to the UFM web UI and click on `Settings` in the left panel.
3. Go to the "Plugin Management" tab.
4. Right-click on the UTM plugin row and select "Add."

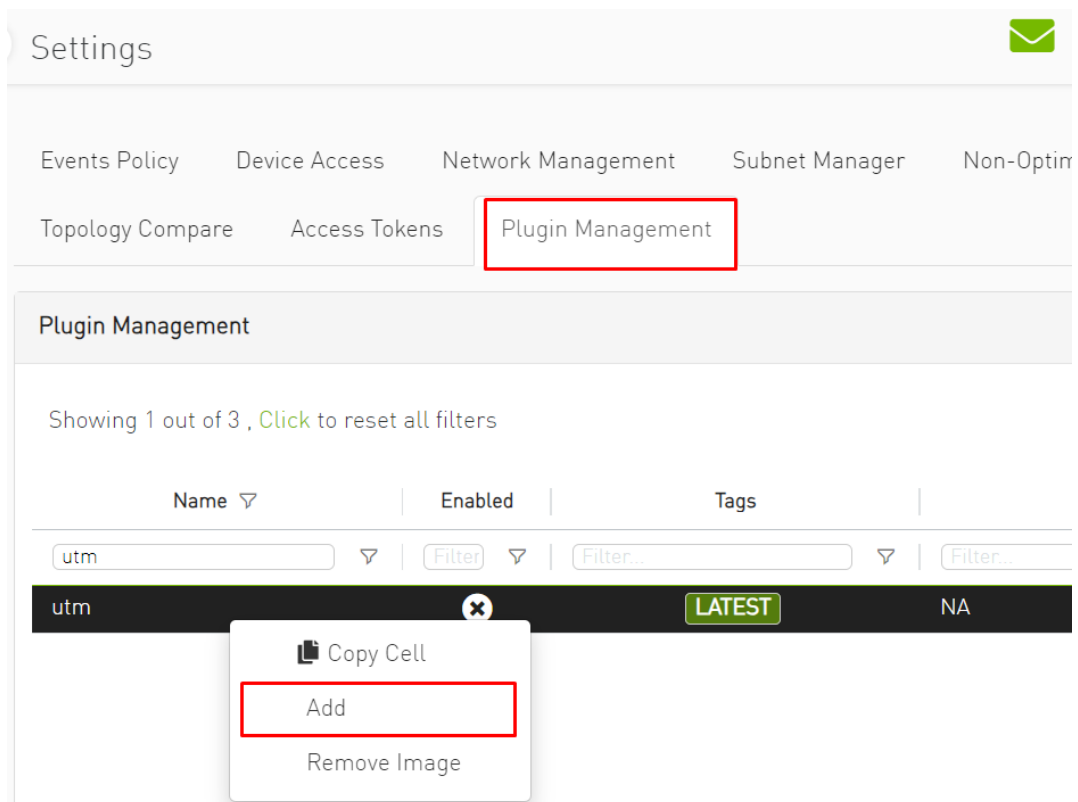

5. Go to the option on the left called "Telemetry Status" to see the UTM UI page.
6. Prepare TI setup using `utm_deployment_scripts` example scripts:
 - a. Change directory:

```
cd $UTM_DEPLOYMENT_SCRIPTS
```

- b. Open and configure `hostlist.txt`
- c. Deploy and run TIs according to `hostlist.txt` and set these TIs to be monitored by UTM:

```
sudo ./examples/run_with_plugin.sh
```

- d. To stop and cleanup TIs setup and unset TIs to be monitored by UTM:

```
sudo ./examples/stop_with_plugin.sh
```

This script does not stop UTM plugin!

To stop the UTM plugin, go to "Plugin Management", right-click on the UTM plugin line and click on `disable`.

If non-default UFM credentials are used, UTM may fail to access the UFM REST API. To resolve this, configure the `ufm` section of the `utm_config.ini` file with `ufm_user=` and `ufm_pass=` to restore the connection between UTM and UFM.

11.18.2.2.1 Default UFM Telemetry Monitoring

UFM Telemetry has high and low-frequency (Primary and Secondary, respectively) TIs that are running by default.

To enable meaningful monitoring:

1. Set `plugin_env_CLX_EXPORT_API_SHOW_STATISTICS=1` in the config files:

```
deployment help
```

```
/opt/ufm/files/conf/telemetry_defaults/launch_ibdiagnet_config.ini  
/opt/ufm/files/conf/secondary_telemetry_defaults/launch_ibdiagnet_config.ini
```

2. Restart telemetry instances with the new config. If UFM Enterprise runs as a docker container, this command should be executed inside the container.

```
deployment help
```

```
/etc/init.d/ufmd ufm_telemetry_restart
```

3. Give TIs some time to update performance metrics. The time depends on the update interval of default TIs.

11.18.2.3 Standalone Mode

In standalone mode, UTM periodically tracks fabric changes by itself and does not require UFM Enterprise.

Deploy via example scripts:

1. Change directory

```
cd $UTM_DEPLOYMENT_SCRIPTS
```

2. Open and configure `hostlist.txt`
3. Deploy and run TIs according to `hostlist.txt` and run UTM:

```
sudo ./examples/run_standalone.sh
```

4. To stop and cleanup TIs setup and UTM, run:

```
sudo ./examples/stop_standalone.sh
```

11.18.2.4 Manual Deployment

This section provides detailed instructions for manually deploying UTM and managed TIs to ensure coverage of all potential corner cases where the convenience script may not be effective.

11.18.2.4.1 UTM Deployment

UTM can be started with two docker run commands.

1. Set `utm_config`, `utm_data`, `utm_log`, and `utm_image` variables.
2. Initialize UTM config:

Initialize UTM

```
docker run -v $utm_config:/config \  
-v $utm_data:/data \  
--rm --name utm-init \  
--device=/dev/infiniband/ \  
$utm_image /init.sh
```

3. Run UTM

Run UTM

```
docker run -d --net=host \  
--security-opt seccomp=unconfined --cap-add=SYS_ADMIN \  
--device=/dev/infiniband/ \  
-v $utm_config:/config \  
-v $utm_data:/data \  
-v $utm_log:/log \  
--rm --name utm $utm_image
```

11.18.2.4.2 Managed/Standalone TIs Manual deployment

TI can be represented either as a UFM Telemetry docker container or as a UFM Telemetry Bring-up package.

To run the docker container in managed mode, `launch_ibdiagnet_config.in` should have the following flags enabled:

TI docker config

```
plugin_env_CLX_EXPORT_API_SHOW_STATISTICS=1  
plugin_env_UFM_TELEMETRY_MANAGED_MODE=1
```

To run UFM Telemetry with Distributed Telemetry, enable its receiver and specify `HCA` to work on:

TI docker config

```
plugin_env_CLX_EXPORT_API_RUN_DT_RECEIVER=1  
plugin_env_CLX_EXPORT_API_DT_RECEIVER_HCA=$HCA
```

To run bringup in managed mode, create `enable_managed.ini` file with the same flags and use `custom_config` option of `collection_start`:

```
TI bringup config
```

```
collection_start custom_config=./enable_managed.ini
```

11.18.2.5 UTM Configuration File

The UTM configuration file `utm_config.ini` is placed under the configuration folder (which is referred to as `UTM_CONFIG` later on this document).

In the case of UFM plugin mode, `UTM_CONFIG = /opt/ufm/files/conf/plugins/utm/`.

In the case of standalone mode, the default value is `UTM_CONFIG = /tmp/managed_telemetry/utm/config` and can be changed via `--data-root` argument of deployment script.

When changes are made to the configuration file, UTM initiates a restart of its main process to apply the updated configuration.

Users may wish to adjust timeout and update rate configurations based on their specific setups. However, it is important to note that the remaining configurations are tailored to enable UTM to function as a UFM plugin and should not be modified.

11.18.2.5.1 Distributed Telemetry

To enable distributed telemetry set `dt_enable=1` in the corresponding section.

Distributed Telemetry requires Switch Telemetry docker image tagged as `switch-telemetry:{version}` and placed under `$UTM_CONFIG/telem_files/` as `switch-telemetry_{version}.tar.gz`

UTM scans this file at its start.

Example deployment scripts handle it for both UFM plugin and standalone modes.

For more details refer to [NVIDIA UFM Telemetry Documentation](#) → Distributed Telemetry - Switch Telemetry Agent

11.18.3 GUI

To access the GUI within the UFM web UI, navigate to the Telemetry status section in the left panel.

The UI is accessible whether it is running as a part of UFM Enterprise or standalone via the endpoint: `http://127.0.0.1:8888/files/index.html`.

The GUI comprises several zones:

- The top pane displays general information and provides options to add a server name/IP and port for monitoring. Users can set the GUI refresh interval in the top right corner.
- The middle panes showcase TI groups, with the default group being basic. Unmanaged (standalone) TIs can be monitored and are placed in the "Unmanaged" group.

- Each group pane presents monitoring information for each TI.
- The bottom pane exhibits system events. Utilize the bottom right menu to navigate through the events history.

Telemetry Status

UFM Telemetry Manager Up Time: 2 mins, 4 secs
Fabric Source: http://127.0.0.1:8000 Refresh interval: 1 second

Add Server

Group name: unmanaged

URL ↑	Mode	DT receiver	Status	Uptime	Collected host/switch ports	Configured host/switch ports	Enabled/Discovered ports	Iteration time (sec)	Export time (sec)	Port counters time (sec)	Ports/sec
http://127.0.0.1:9001	standalone/host	0	Running	2 hours, 28 mins, 21 secs	0+35/-		30/173	0.000723	1e-05	0.000391	
http://127.0.0.1:9002	standalone/host	0	Running	2 days, 21 hours, 11 mins, 45 secs	173/-		30/173	0.38699	0.001255	0.037979	4555.15

Group name: default
Number of Discovered Ports: 30
Status Message: Sampled 29/30 ports. Cluster is sampled at max rate of 280.5 Hz.

URL ↑	Mode	DT receiver	Status	Uptime	Collected host/switch ports	Configured host/switch ports	Enabled/Discovered ports	Iteration time (sec)	Export time (sec)	Port counters time (sec)	Ports/sec
http://localhost:8123	managed/host	1	Running	50 secs	9/-	9/-	30/173	0.003565	8.2e-05	0.002276	3954.31
http://localhost:8124	managed/host	1	Running	50 secs	20/-	20/-	30/173	0.005695	9.7e-05	0.004665	4287.25

Events

Severity	Time	Source	Group	Description
info	2024-05-05 11:33:18.65627	http://localhost:8124	default	Updated Telemetry Instance with 20 ports
info	2024-05-05 11:33:18.652747	http://localhost:8123	default	Updated Telemetry Instance with 9 ports
info	2024-05-05 11:33:18.257047	http://localhost:8124	default	Host TI config updated. New config_hash=1dc7e0a8aedf520c0940219c45200549c30b6dbd690856b12a7e5aa8fed0788
info	2024-05-05 11:33:18.256252	http://localhost:8124	default	Host TI op updated. New op_info={op_lid: 7, 'op_port': 1, 'op_num': 5776-5777, 'total_ops': 2, 'timestamp': 1714908793139835}
info	2024-05-05 11:33:18.249813	http://localhost:8123	default	Host TI config updated. New config_hash=8723213085d64e1b913b798471eb1e6ae5863bb6e905e81da33f0fb147e952

Viewing 1-5 of 35 ⏪ ⏩ 5

11.18.3.1 TI Management

In managed mode, UTM can dispatch commands to TIs. By right-clicking on the TI line, users can:

- Pause a currently running TI. This action redistributes fabric sharding among the active TIs.
- Resume a paused TI.
- Exclude a TI from monitoring. Although the TI remains on the machine, it enters a paused state and is removed from its group. It's important to note that empty TI groups are automatically removed.

11.18.3.2 Telemetry Status Fields

The table below lists each column of a Telemetry Group panel:

Field Name	Description
URL	TI URL in format <code>http://{hostname}:{port}</code> or <code>http://{IP}:{port}</code>
Mode	standalone or managed / platform
DT receiver	With or without a Distributed Telemetry receiver. If 0, cannot receive DT data from a switch TI
Status	Down, Running, Initializing, Paused, or Restarting
Uptime	TI uptime in human-readable format

Field Name	Description
Collected host/switch ports	Ports collected from the host/switch. By default data that did not change from the last sample is not being re-exported. Such data is shown in the host part as +num_old_ports. In the screenshot above. first TI of the "unmanaged" group sampled 0 new data samples and found 35 old ones. Nothing is being sampled from Distributed Telemetry, because this TI runs without DT receiver. The resulting format is: 0+35/-
Configured host/switch ports	Ports configured to be sampled from a host and corresponding switches in total. For more details refer to Distributed Telemetry documentation .
Enabled/discovered ports	Enabled and discovered ports of the Fabric.
Iteration time	Total iteration time of UFM Telemetry data collection
Export time	Export time in the last iteration of UFM Telemetry data collection. Included to <code>Iteration time</code>
Port counters time	Time spent only on port counters telemetry collection. Included to <code>Iteration time</code>
Ports/sec	Speed of new port counters data collection during the last iteration of UFM Telemetry.

11.18.4 REST API

All the GUI features including TI management and monitoring can be accessed via REST API.

11.18.4.1 Accessing UTM API Commands Based on Operating Mode

The method to access UTM API commands varies depending on the mode:

- In UFM Plugin Mode: Use the UFM REST API proxy:

```
curl -s -k https://{UFM_HOST_IP}/ufmRest/plugin/utm/{COMMAND} -u {user}:{pass}
```

- In Standalone Mode: Access the UTM HTTPS endpoint on the default port `8888` :

```
curl -s -k https://{UTM_HOST_API}:8888/{COMMAND}
```

11.18.4.2 Command List

For simplicity, the following commands are provided for standalone mode.

- [Get the list of supported user endpoints:](#)

Standalone UTM help

```
curl -s -k https://127.0.0.1:8888/help
```

- Get the status of the monitored TIs in JSON format:

Standalone UTM help

```
curl -k https://127.0.0.1:8888/status
```

- Add TI <http://127.0.0.1:8123> to the `my_group` monitoring group:

Standalone UTM help

```
curl -k 'https://127.0.0.1:8888/add_server?url=http://127.0.0.1:8123&group=my_group'
```

- Add TI <http://127.0.0.1:8123> to `default` monitoring group:

Standalone UTM help

```
curl -k https://127.0.0.1:8888/add_server?url=http://127.0.0.1:8123
```

- Remove TI from monitoring (running TI will be paused):

Standalone UTM help

```
curl -k https://127.0.0.1:8888/remove_server?url=http://127.0.0.1:8123
```

- Pause running TI:

Standalone UTM help

```
curl -k https://127.0.0.1:8888/pause_server?url=http://127.0.0.1:8123
```

- Resume paused TI:

Standalone UTM help

```
curl -k https://127.0.0.1:8888/start_server?url=http://127.0.0.1:8123
```

11.19 UFM Consumer Plugin

11.19.1 Overview

The UFM consumer plugin is a self-contained Docker container with REST API support, under UFM management. It serves as a Multi-Subnet consumer within UFM, offering all the functionalities available for Multi-Subnet UFM.

The Multi-Subnet UFM feature allows the management of large fabrics spanning multiple sites within a single product, specifically Multi-Subnet UFM.

This feature comprises two layers: UFM Multi-Subnet Provider and UFM Multi-Subnet Consumer (UFM consumer plugin).

The UFM Provider acts as a Multi-Subnet Provider, exposing all local InfiniBand fabric information to the UFM consumer plugin. On the other hand, the UFM consumer plugin functions as a Multi-Subnet Consumer, gathering and consolidating data from configured UFM Providers. This enables users to manage multiple sites conveniently in one location. While the UFM Consumer offers similar functionality to regular UFM, there are behavioral differences concerning aggregation.

Upon deployment of the UFM consumer plugin, an additional tab is incorporated into the UFM interface.

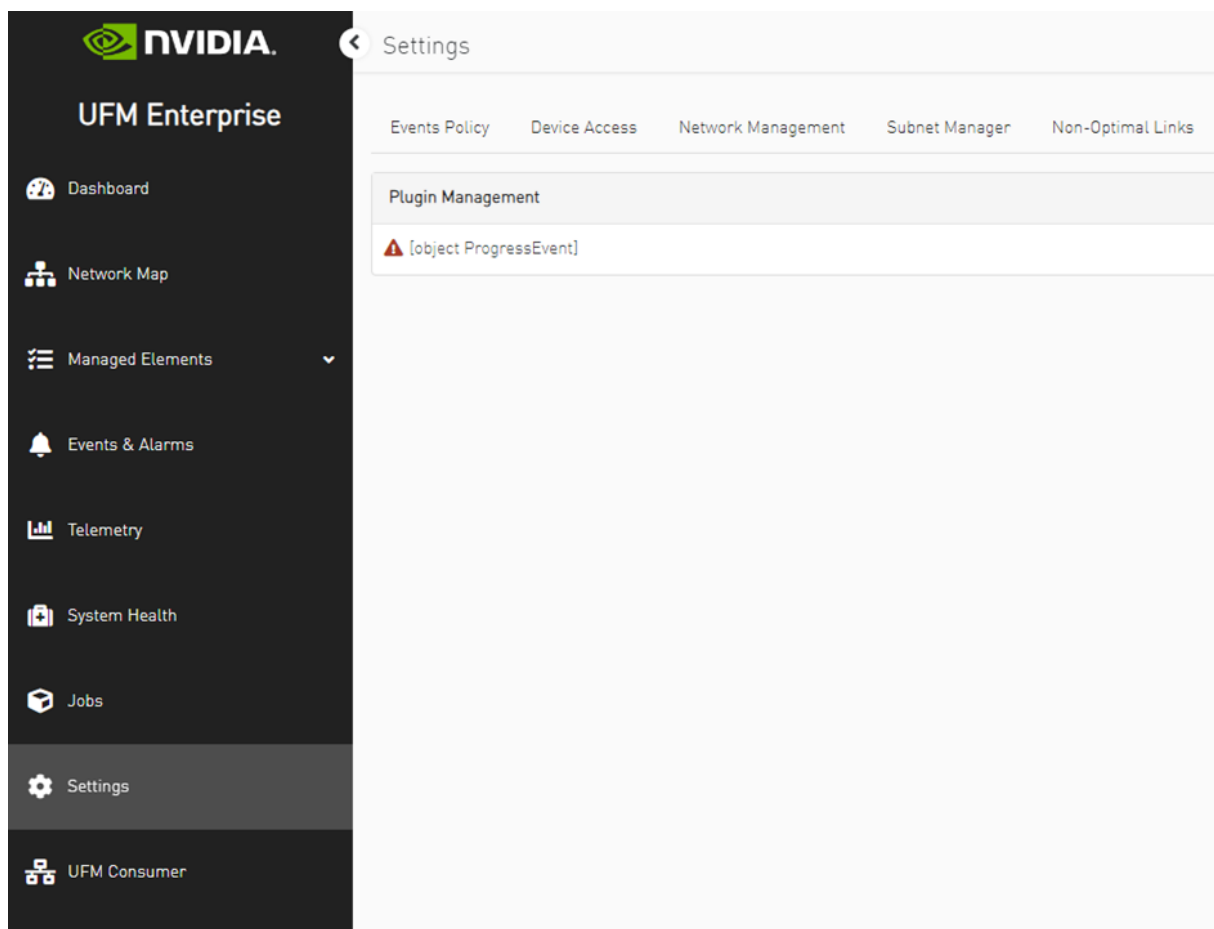

After clicking on UFM consumer plugin UI, a new browser tab with UFM Multi-Subnet consumer functionality options is presented. Upon the initial launch of the UFM consumer plugin UI and in case there are no configured providers, a screen for adding providers (Provider Management) will be displayed.

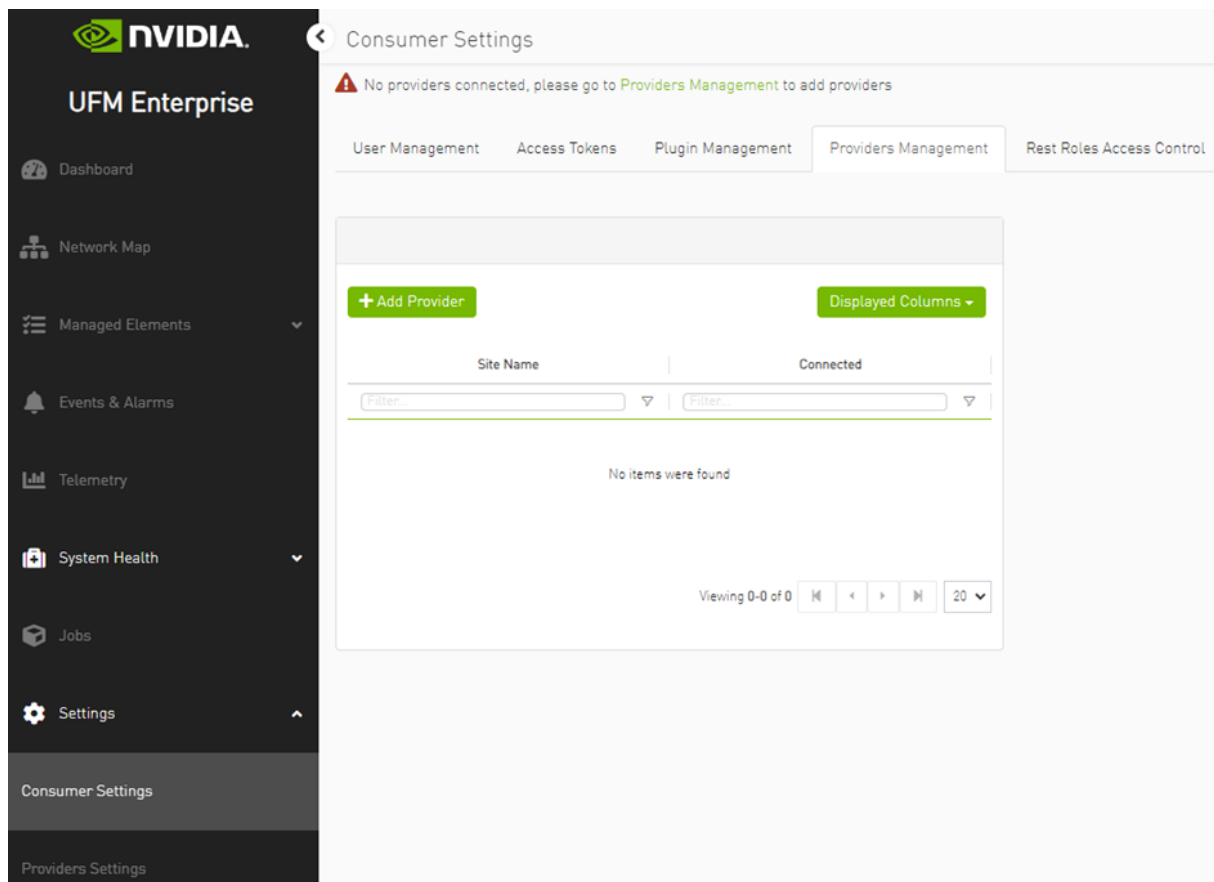

The functionality of the UFM consumer plugin is similar to that of Multi-Subnet UFM. For further details, refer to [Multi-Subnet UFM](#).

11.20 Fast-API Plugin

11.20.1 Overview

The Fast-API plugin is a new component that runs in parallel to the UFM model and provides a more scalable and efficient way to manage the inventory and topology of the fabric. It uses a Redis database to store the data it receives from the SM client consumer and the ibdiagnet collector. It also exposes REST APIs for querying the ports, systems, links, switches, and sharp reservations. The Fast-API plugin also supports persistent inventory, which means it keeps track of all the devices, ports, and links the UFM ever encountered, even if they are disabled or removed. The Fast-API plugin is designed to be backward compatible with the UFM model, except for some minor differences in the API parameters and the handling of generic node names.

11.20.2 Deployment

- As a first step, get the Fast API image:

```
docker pull mellanox/ufm-plugin-fast_api
```

- Load the downloaded image onto the UFM server. This can be done either by using the UFM GUI by navigating to the Settings -> Plugins Management tab or by loading the image via the following instructions:
 - a. Log in to the UFM server terminal.
 - b. Run:

```
docker load -I <path_to_image>
```

- After successfully loading the plugin image, the plugin should become visible in the plugin management table within the UFM GUI. To initiate the plugin's execution, simply right-click on the respective in the table.

11.20.3 SequencDiagram

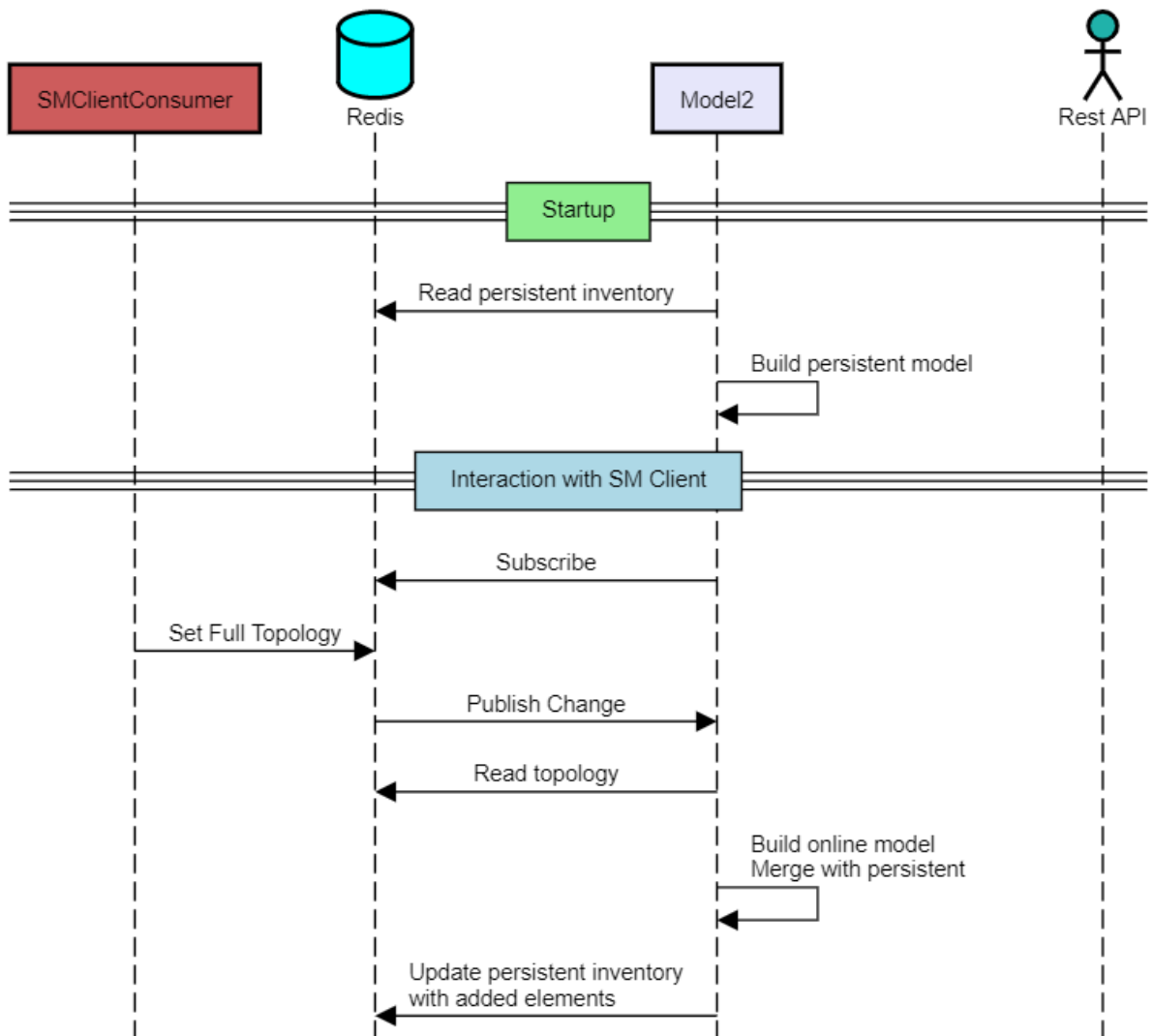

11.20.4 Sequence Diagram

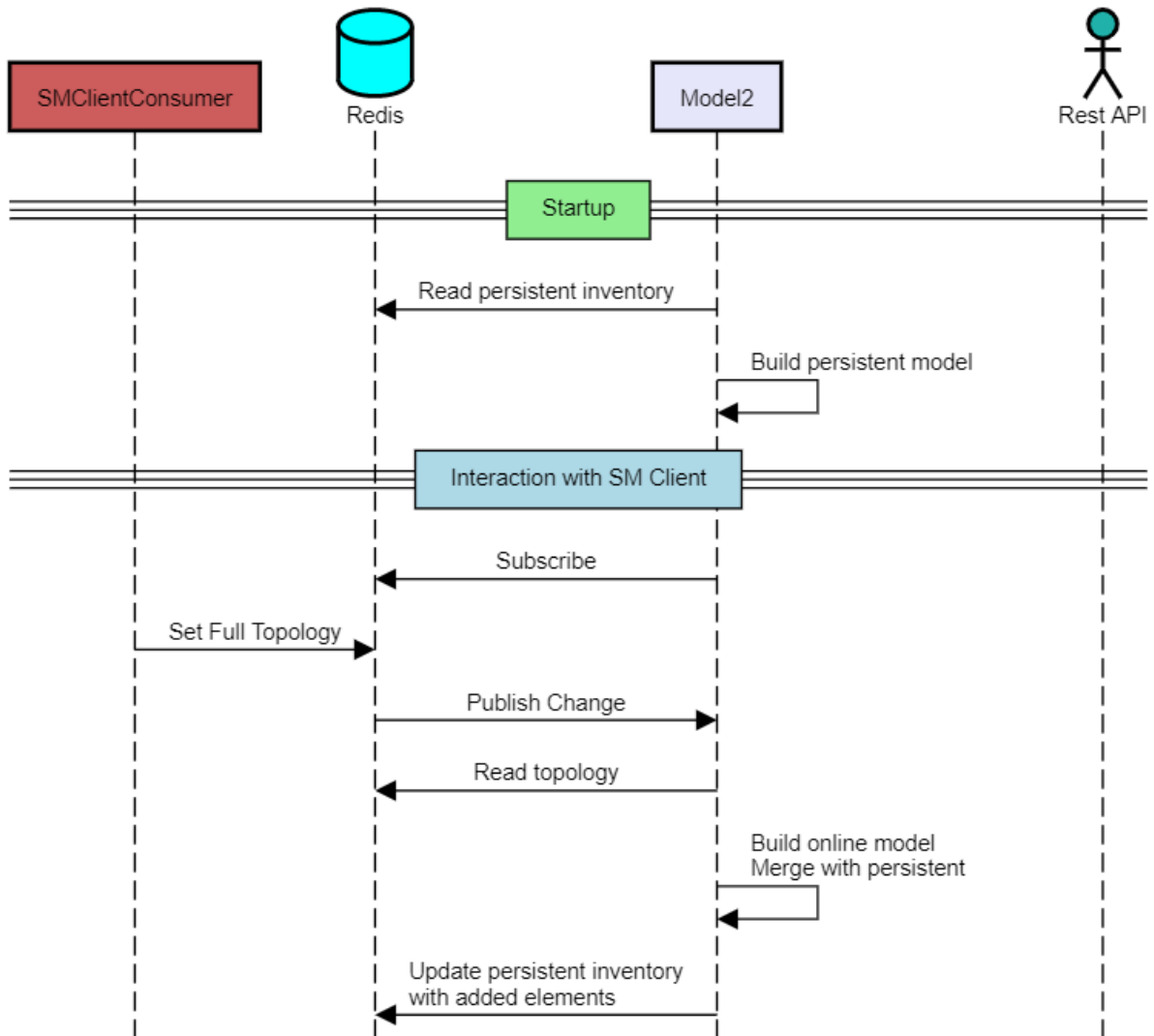

11.20.5 Supported APIs

The following APIs are supported:

Ports API - Retrieve all the ports in the cluster or filter by the system name. The following attributes are retrieved:

- GET https://<UFM_IP>/ufmRestV2/plugin/fast_api/resources/ports
- GET /resources/ports/ - deviceId referred as sys_guid for switches and hostname for hosts
 - name : The name of the port.
 - lid : The local ID of the port.
 - logical_state : The logical state of the port.
 - physical_state : The physical state of the port.

- `number` : The number of the port.
- `decimal_guid` : The decimal GUID of the port.
- `mtu` : The maximum transmission unit of the port.
- `active_speed` : The active speed of the port.
- `active_width` : The active width of the port.
- `peer_address` : The peer address of the port.
- `peer_port` : The peer port of the port.
- `tier` : The tier of the port.
- `label` : The label of the port.

This API retrieves all the ports in the cluster, including cable information. The following attributes are supported for cable information:

- GET https://<UFM_IP>/ufmRestV2/plugin/fast_api/resources/ports/?cable_info=true
 - `part_number` : The part number of the cable.
 - `serial_number` : The serial number of the cable.
 - `revision` : The revision of the cable.
 - `identifier` : The identifier of the cable.
 - `length` : The length of the cable.
 - `technology` : The technology of the cable.
 - `fw_version` : The firmware version of the cable.

Links API - Retrieve all the links in the cluster. The following attributes are retrieved:

- GET https://<UFM_IP>/ufmRestV2/plugin/fast_api/resources/links
 - `source_guid` : The GUID of the source port.
 - `source_port` : The source port.
 - `destination_guid` : The GUID of the destination port.
 - `destination_port` : The destination port.
 - `source_port_dname` : The display name of the source port.
 - `source_port_name` : The name of the source port.
 - `destination_port_dname` : The display name of the destination port.
 - `destination_port_name` : The name of the destination port.
 - `width` : The width of the link.
 - `severity` : The severity of the link.
 - `source_port_node_description` : The description of the node connected to the source port.
 - `destination_port_node_description` : The description of the node connected to the destination port.
 - `name` : The name of the link.
 - `active` : The status of the link.

This API retrieves information about the systems in the cluster. It can retrieve all the systems or filter by the system name. The following attributes are retrieved:

- GET https://<UFM_IP>/ufmRestV2/plugin/fast_api/resources/systems
- GET https://<UFM_IP>/ufmRestV2/plugin/fast_api/resources/systems/<system_name>

- GET https://<UFM_IP>/ufmRestV2/plugin/fast_api/resources/switches
 - `name` : The display name of the system.
 - `system_name` : The name of the system.
 - `guid` : The GUID of the system.
 - `sys_guid` : The system GUID.
 - `ports` : A list of ports associated with the system.
 - `hostname` : The hostname of the system.
 - `vendor` : The vendor of the system.
 - `temperature` : The temperature of the system.
 - `fw_version` : The firmware version of the system.
 - `technology` : The technology used by the system.
 - `level` : The level of the system.
 - `uptime` : The uptime of the system.
 - `sw_version` : The software version of the system.
 - `system_type` : The type of the system.
 - `description` : The description of the system.
 - `psid` : The PSID of the system.
 - `active` : The status of the system.
 - `state` : The state of the system.
 - `is_managed` : Indicates whether the system is managed.

11.21 UFM Light Plugin

11.21.1 Overview

UFM Light is a C++ UFM plugin designed to create a reduced UFM model and deliver a high-performance REST API. While it builds a model similar to the legacy UFM, there are notable differences:

- The model in UFM Light is streamlined to meet the specific requirements of the UFM Light REST API functionality.
- UFM Light builds its model more quickly.

UFM Light offers the same REST API as the legacy UFM, but with enhanced performance.

11.21.2 Deployment

11.21.2.1 Prerequisites

1. UFM is running
2. Fast-API plugin is running

UFM Light builds its model from the Redis inventory and requires the Fast-API plugin as the inventory provider. Writing to Redis must be enabled in UFM.

11.21.2.2 Installation

1. Get UFM Light image:

```
docker pull mellanox/ufm-plugin-ufm-light
```

2. Load UFM Light plugin:

```
sudo /opt/ufm/scripts/manage_ufm_plugins.sh add -p ufm-light -t <version>
```

3. Configure the UFM Light plugin if needed (see "Configuration" section).

Note: it is recommended to configure parameter `--http.threads` to "4" for 16-Core systems, "16" for 64-Core systems.

11.21.2.3 Configuration

UFM Light runs with its default configuration. To update the configuration, edit:

```
sudo vim /opt/ufm/files/conf/plugins/ufm-light/ufm-light.cfg
```

If `ufm-light.cfg` is updated, the UFM Light plugin must be stopped and started again manually to apply the changes:

```
sudo /opt/ufm/scripts/manage_ufm_plugins.sh stop -p ufm-light
sudo /opt/ufm/scripts/manage_ufm_plugins.sh start -p ufm-light
```

11.21.2.4 Configuration Options:

```
--model.srcmode arg (=redis:invnt)  base source of model: redis:invnt, redis:full, grpc
--model.period arg (=30)             set farbric request period in seconds
--redis.address arg (=localhost)     set Redis address
--redis.port arg (=6379)             set Redis port
--grpc.address arg (=localhost)      set gRPC address
--grpc.port arg (=2510)              set gRPC port
--telemetry.address arg (=localhost) set Telemetry address
--telemetry.port arg (=9001)         set Telemetry port
--telemetry.url arg (=csv/cset/converted_enterprise) set Telemetry url
--http.address arg (=127.0.0.1)      set http address
--http.port arg (=8950)              set http port
--http.threads arg (=1)              set number of http server threads, min 1
--logging.level arg (=INFO)          set logging level: CRITICAL, ERROR, WARNING, INFO, DEBUG, TRACE
--logging.log_dir arg (=log)         set logging directory
--logging.file.max_size_MB arg (=10) set MAX log file size limit in MBs, min 1
--logging.file.backups arg (=10)     set number of log file backups
```

For normal operation, keep the parameter `model.srcmode = redis:invnt` at its default value. Other values (`redis:full`, `grpc`) can be set, but the model will not be fully built. This feature is not part of the current release. Parameters `grpc.address` and `grpc.port` will have no effect.

Note: it is recommended to configure parameter `--http.threads` to "4" for 16-Core systems, "16" for 64-Core systems.

11.21.3 Supported REST API

Telemetry API:

- GET `monitoring/session/0/data`

Access methods:

- Direct access:

```
curl http://127.0.0.1:8950/monitoring/session/0/data
```

- Over plugins API:

```
curl -k https://<lab_ip>/ufmRest/plugin/ufm-light/monitoring/session/0/data -u <user>:<password>
```

11.21.4 Troubleshooting

If the response to `GET monitoring/session/0/data` contains an empty dictionary, ensure that the Fast-API plugin is running.

UFM Light logs are located in:

```
/opt/ufm/files/log/plugins/ufm-light/
```

The default log level is `INFO`. To change the log level to `DEBUG`, edit:

```
sudo vim /opt/ufm/files/conf/plugins/ufm-light/ufm-light.cfg
logging.level = DEBUG
```

After config update, `ufm-light` plugin must be stopped and started again manually in order to obtain config changes.

11.22 Key Performance Indexes (KPI) Plugin

The KPI plugin periodically collects telemetry metrics and topology data from one or multiple UFM Telemetry and UFM clusters to calculate high-level Key Performance Indicators (KPIs). It can operate as a standalone Docker container or as a UFM plugin.

The calculated KPIs and collected telemetry metrics are stored in a Prometheus time-series database using the remote-write Prometheus protocol.

11.22.1 KPIs

11.22.1.1 NICs Connectivity

- Name: `connected_endpoints`
- Description: This KPI shows the percentage of NICs connectivity, namely, from all NICs available, how many are connected. The desired value is 100%, meaning all NICs are connected.

The default threshold for "bad" values is $\leq 95\%$.

The complete list of NICs includes all those detected at least once since the plugin is started.

Topology Correctness

- Name: `topology_correctness`
- Description: This KPI reports the number of wrongly connected links. The ability to spread traffic over multiple minimal-distance paths is critical in utilizing the bandwidth provided by the network.
Therefore, a pass/fail criteria for the topology not being broken by miss-connections is key for the network to provide reasonable bandwidth to running applications. The threshold for failure is > 0 .

11.22.1.2 Link Stability

- Name: `stability`
- Description: For each UID (Unique Identifier), the KPI checks for changes in the link down counter. A change may indicate a link recovery, suggesting there was a period with no link. The statistics are tracked per UID, and the ideal value for link down errors is 0, indicating no problematic links.

11.22.1.3 Overheated Components

- Name: `operating_conditions`
- Description: This KPI displays the total number of elements (ports and devices) experiencing operating condition violations. Each hardware element has a predefined normal operating temperature range, with a common default threshold set at 70°C (158°F) or higher.

11.22.1.4 Bandwidth Loss due to Congestion

- Name: `bw_loss_by_congestion`
- Description: An Infiniband (IB) network is lossless and can therefore experience loss congestion spread. Features like congestion control aim to minimize this issue. This KPI reports the percentage of bandwidth loss due to congestion for each layer and direction, as measured by the `port-xmit-wait` counter.
The reported percentage is calculated by averaging the `xmit-wait` equivalent time with the time between samples across all links in the specified layer-direction group.

11.22.1.5 Fat Tree (Single Root) to Tree Conversion

- Name: `tree_over_subscription`
- Description: Fat Trees were constructed by Leiserson in order to enable building a tree structure using fixed radix K and capacity switches T . Consider a regular $K-1$ tree (each switch has one parent and $K-1$ children), which have a single root switch service and after $H-1$ levels $(K-1)^{(H-1)}$ leaf switches connecting $(K-1)^H$ hosts each with bandwidth B . Consider the worst case traffic pattern where each leaf switch send traffic to other leaf switches that must cross

the top. The connection from each leaf switch up should carry $B(K-1)$ traffic and the capacity of that switch is bi-directional $B(K-1)$ too. One level up the capacity and up link capacity required is $B(K-1)^2$, etc. But that requires exponentially growing capacity from links and switches.

For example, the below diagram is of a three level fat tree:

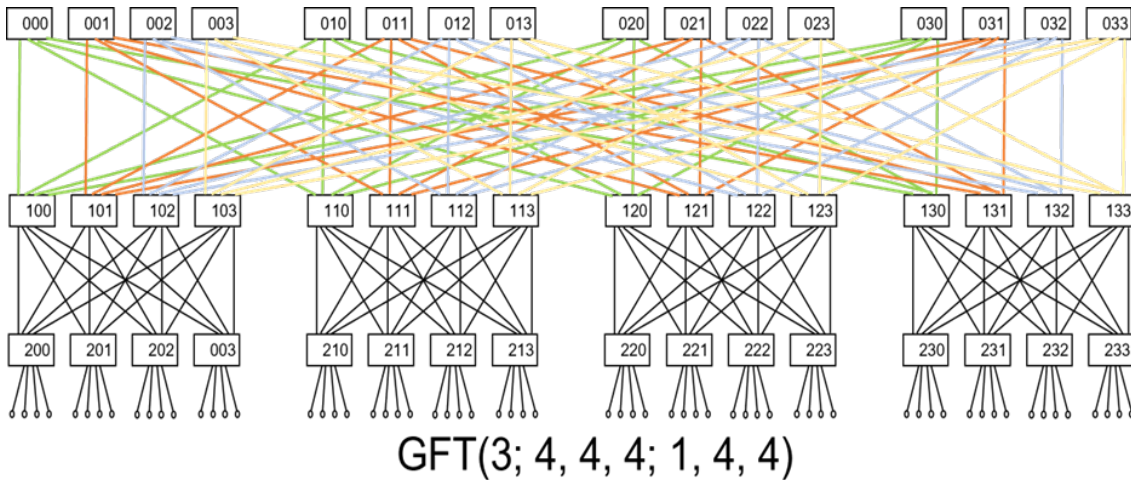

The Single Root Tree:

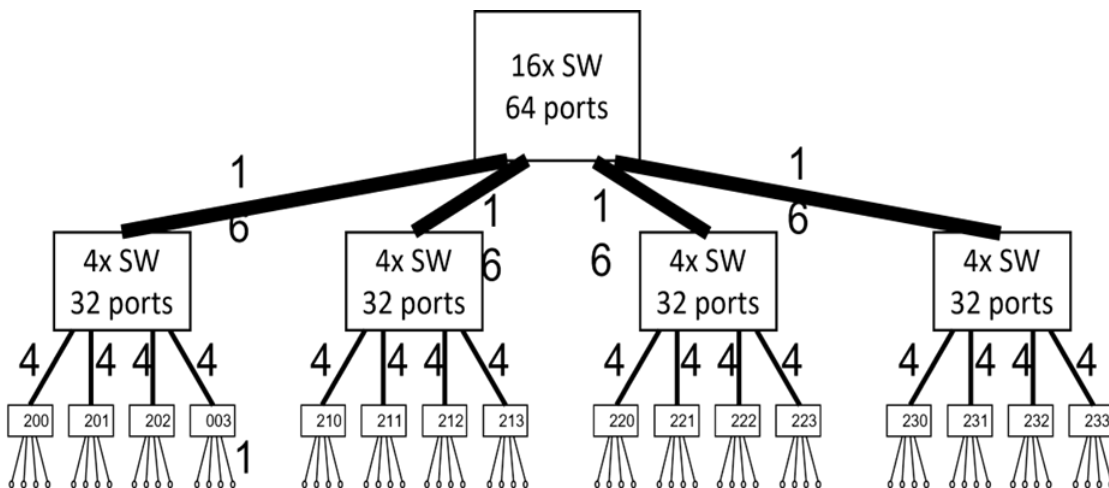

The solution to that problem was to split each single switch in the original Single Root Tree (SRT) into Multi Rooted Tree - which is a Fat Tree. In each level there are exactly same number of switches connected up and down except for the top level which carry half the number of switches - connecting only down.

The Fat Tree formulations define which switches connect to which other switches but it does not break the basic concept that a Fat Tree can be collapsed back into a simple tree by merging switches into much larger ones. A pair of leaf switches can still be classified by their distance - or the level of their common parents - just like in the original SRT.

When we want to evaluate the damage to the perfect tree structure due to link faults, it is very hard to get an exact maximum flow bandwidth without lengthy N^2 complex algorithm. However, if

we examine the SRT obtained by collapsing the Fat Tree back into a tree, we can get an upper bound to the available bandwidth between different branches of the SRT.

This metric evaluates Fat Tree clusters topology and extracts their original Tree structure. Then it evaluates the over-subscription of each sub-tree. This way, the impact of the exact set of missing links can be evaluated in terms of the bandwidth taken out between sub-trees of the topology.

11.22.1.6 Top-of-rack (ToR) to ToR Max Flow (Bandwidth) Matrix

- Name: `tor_to_tor_bw`
- Description: This KPI provides a simple metric for the impact of link failures. One such network property is the available bandwidth for pairs of ToRs. This provides a meaningful yet traffic independent metric. So no prior knowledge of the exact set of instantaneous traffic patterns is required.

It is most important to look at the TOR up-ports since on Fat Trees the number of possible paths rows exponentially when going up the topology towards the roots. So the impact of link faults is decaying exponentially with their level towards the roots.

It would have been nice if we could just count the number of missing up links on each of the TORs in the pair and claim that TOR X lost x uplinks and TOR Y lost y uplinks, the lost bandwidth is $\text{linkBW} * \min(x, y)$. But in reality the worst case lost bandwidth is $\text{linkBW} * (x + y)$. This is an artifact of the specific links lost and the network structure.

The code we provide performs a Fat Tree specific computation of the exact available bandwidth for each TOR's pair.

The algorithm provides unique identifiers for sub-trees and consider the subtree each link of the TORs connect to. Then it sums the min number of links connected from each of the TORs to each of the subtrees.

A more straight forward approach utilizing networkx or direct implementation of Dinic's max-flow algorithm yielded much higher runtime, yielding this metric impractical to use.

We use an example to demonstrate these concepts:

Consider the Fat Tree $GFT(3; 4, 4, 4; 1, 4, 4)$ depicted in the diagram below:

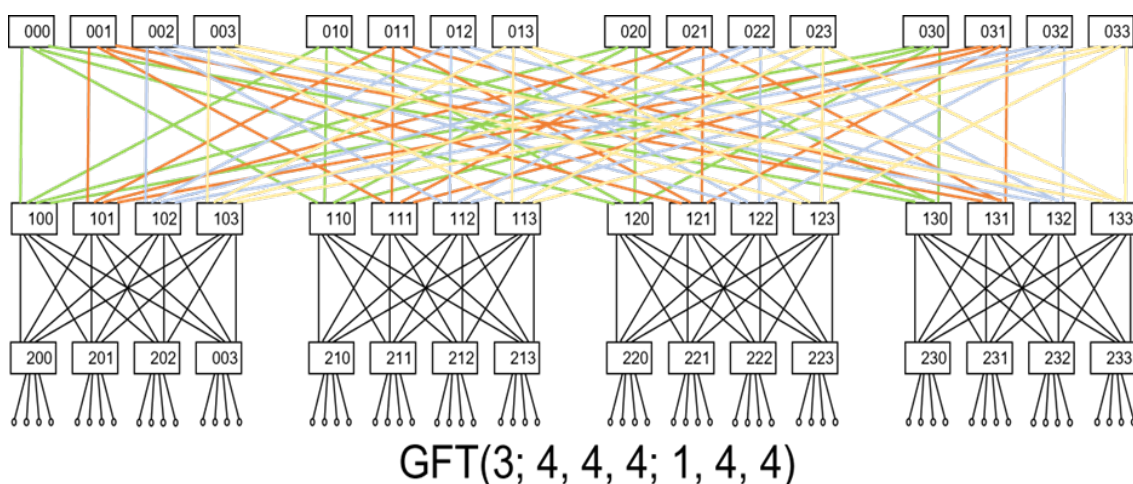

We re-arrange the top row of switches (cores) such that the full-bipartites between switch levels 2 and 3 are close together:

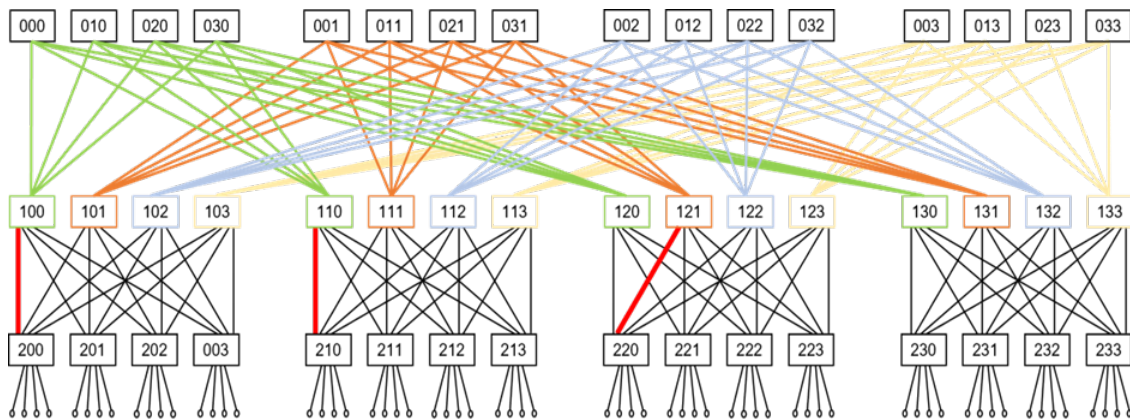

GFT(3; 4, 4, 4; 1, 4, 4) Cores Reordered

The re-ordered picture highlights that if we imagine the red links as missing links, then:

1. TORs 200 and 210 missing links are connected to the same bipartite and thus they only lose 1 out of the 4 paths between them.
2. However, TORs 200 and 220, missing links connect to 2 different L2-L3 bipartites and thus 2 different paths out of the 4 possible are lost.

The resulting TOR to TOR max-flow matrix, providing the maximal bandwidth between each pair, in units of single link bandwidth is provided below:

	00	01	02	03	10	11	12	13	20	21	22	23	30	31	32	33
100	3	3	3	3	3	3	3	3	2	3	3	3	3	3	3	3
101	3	4	4	3	4	4	4	3	4	4	4	4	4	4	4	4
102	3	4	4	3	4	4	4	3	4	4	4	4	4	4	4	4
103	3	4	4	3	4	4	4	3	4	4	4	4	4	4	4	4
110	3	3	3	3	3	3	3	2	3	3	3	3	3	3	3	3
111	3	4	4	3	4	4	4	3	4	4	4	4	4	4	4	4
112	3	4	4	3	4	4	4	3	4	4	4	4	4	4	4	4
113	3	4	4	3	4	4	4	3	4	4	4	4	4	4	4	4
120	2	3	3	3	2	3	3	3	3	3	3	3	3	3	3	3
121	3	4	4	3	4	4	4	3	4	4	4	4	4	4	4	4
122	3	4	4	3	4	4	4	3	4	4	4	4	4	4	4	4
123	3	4	4	3	4	4	4	3	4	4	4	4	4	4	4	4
130	3	4	4	3	4	4	4	3	4	4	4	4	4	4	4	4
131	3	4	4	3	4	4	4	3	4	4	4	4	4	4	4	4
132	3	4	4	3	4	4	4	3	4	4	4	4	4	4	4	4
133	3	4	4	3	4	4	4	3	4	4	4	4	4	4	4	4

The Algorithm

The following steps are conducted in order to provide that table:

1. DFS from top to bottom collecting the list of parents for each switch. We require all TORs be accessed so we try all top level switches until we find one that is connected to all TORs. After

- we are done we can ask for every TORs pair what is the level of the lowest common parent. This is required since routing will only use shortest paths, and thus go up to that level only.
2. Establish for each TOR and up the unique bottom-up subtree it is part of. The same sub-tree number should be used for all parents of each switch that are on the same level. Since the topology may be missing some links, it is not simple to check if there was previous allocation of such number, so first all parents are scanned, and then a consolidation step decides which levels are missing a number. If any needs to be set then another step applies the consolidated value.
 3. For TOR switch, we sum the total number of links that connect to switches with same bottom-up tree (recognized by their assigned number). We do that for every parent level.
 4. Now that we have that data for every TOR, we compute the TOR to TOR max-flow by first looking up the level of their common parent and then computing the the minimal number of flows they connect to each bottom-up tree they connect to.

11.22.2 Deployment

The plugin could be deployed as a standalone application or as a UFM plugin.

11.22.2.1 Deploy the KPI as a UFM plugin

1. Pull/load the latest image of the plugin:

```
docker pull mellanox/ufm-plugin-kpi
```

2. Pull/load the latest image of the plugin:

```
/opt/ufm/scripts/manage_ufm_plugins.sh add -p kpi -t <TAG>
```

11.22.2.2 Deploy the KPI as a Standalone application

1. Pull/load the latest image of the plugin:

```
docker pull mellanox/ufm-plugin-kpi
```

2. Pull/load the latest image of the plugin:

```
docker run --network host -v /opt/ufm/files/conf/plugins/kpi:/config -v /opt/ufm/files/logs/plugins/kpi:/logs --rm -dit $IMAGE
```

11.22.3 Configurations

The configurations can be managed through a configuration file.

- Within the container, the configurations file can be found under `/config/kpi_plugin.conf`
- On the host, the shared volume location of the `/config` is `/opt/ufm/files/conf/plugins/kpi/kpi_plugin.conf`

11.22.3.1 Clusters Configurations

The default KPI configurations KPI include one default cluster called `unknown`, once the plugin starts, the default cluster is configured to collect the secondary telemetry endpoint <http://localhost:9002/csv/metrics> and the local UFM topology data.

To change the parameters of the default cluster, or to add additional clusters, please refer to the following configuration under the `kpi_plugin.conf` :

```
### Set name to "cluster-config-$cluster_name". Add section per each cluster
[cluster-config-unknown]

### uncomment and set 2 following options:
#host_list = host_name[1-1024],another_host_name[1-100]
### threshold to distinguish between hosts and switches (inclusive)
#host_max_ports = 4

### OR

### If hostlist format is not possible, another option is per-level regular expressions
### That is a list of regular expressions to detect nodes level in topology (0 is lowest - hosts)
### Key structure is 'level.<level number>.<per-level running index>'
#level.0.0=some-host-pattern-\d+
#level.0.1=another-host-pattern-\d+
#level.1.0=leaf-pattern-1\d+
#level.2.0=spine-pattern-s\d+
#level.3.0=core-pattern-c\d+

### If running as standalone app please uncomment and set next 3 lines
#ufm_ip=0.0.0.0
#ufm_access_token=1234567890abcdefghijklmnopqrstuvwxyz
#telemetry_url=http://0.0.0.0:9100

### If running as UFM plugin and UFM port has changed
#ufm_port=1234
```

Property	Description	Default Value
<code>cluster.host_list</code>	Set of hosts in hostlist format . Used to detect the topology leafs.	None
<code>cluster.host_max_ports</code>	The maximal number of ports in a server. Used as threshold to classify a node as server / switch.	4
<code>cluster.level.X.Y</code>	Regular Expression to capture topology levels. The first index (X) is the level and the following index (Y) is a running index for level X	None
<code>cluster.ufm_ip</code>	UFM IP that used to collect the topology data	'127.0.0.1'
<code>cluster.ufm_port</code>	UFM port that used to collect the topology data in case the cluster is local	'8000'
<code>cluster.ufm_access_token</code>	The UFM access token that should be provided in case the cluster is collecting data from a remote UFM	None
<code>cluster.telemetry_url</code>	UFM telemetry endpoint URL that used to collect the telemetry metrics.	' http://127.0.0.1:9002 '
<code>cluster.telemetry_metrics_push_delta_only</code>	If True, only changed telemetry metrics are pushed to Prometheus after each pulling interval, with a fallback to push unchanged metrics if they remain static for over an hour. Otherwise, all fetched metrics will be pushed to the Prometheus after each pulling interval	True

11.22.3.2 KPI Configurations

The configurations are related to the KPI plugin itself. please refer to the below configuration section in order to manage the KPI generic configurations:

```
[kpi-config]
### Optional Comma separated list that contains list of the disabled KPIs that we don't want to store them in
Prometheus DB
### Available KPIs:
###
connected_endpoints, topology_correctness, stability, operating_conditions, bw_loss_by_congestion, tree_over_subscription,
tor_to_tor_bw, general, telemetry_metrics
disabled_kpis=telemetry_metrics
```

Property	Description	Default Value
disabled_kpis	Optional Comma-separated list that contains the list of the disabled KPIs that we don't want to store in Prometheus DB. The available KPIs are: connected_endpoints, topology_correctness, stability, operating_conditions, bw_loss_by_congestion, tree_over_subscription, tor_to_tor_bw, general, telemetry_metrics	telemetry_metrics

11.22.3.3 Prometheus Configurations

The plugin includes a local Prometheus server instance that is used by default, the following parameters are used to manage the Prometheus configurations:

```
[prometheus-config]
prometheus_ip=0.0.0.0
prometheus_port=9090
prometheus_db_data_retention_size=120GB
prometheus_db_data_retention_time=15d
```

Property	Description	Default Value
prometheus_ip	IP of Prometheus server	0.0.0.0
prometheus_port	Port of Prometheus server	9090
prometheus_db_data_retention_size	Data retention policy by size (used only for the local Prometheus server)	120GB
prometheus_db_data_retention_time	Data retention policy by time (used only for the local Prometheus server)	15d

The data storage path of the local Prometheus DB is under `/opt/ufm/files/conf/plugins/kpi/prometheus_data`.

11.22.3.4 Global Time Interval Configurations

The following is used by all clusters globally, each property could be overridden by adding it under the cluster's section.

```
[time-interval-config]
telemetry_interval=300
ufm_interval=60
```

Property	Description	Default Value
telemetry_interval	Polling interval for the telemetry metrics data in seconds	300
ufm_interval	Polling interval for the UFM APIs in seconds	60
disabled_kpis	Polling interval for the connected_endpoints KPI specifically	60

11.22.3.5 Logs Configurations

The below configurations are to manage the `kpi_plugin.log` file

```
[logs-config]
logs_level = INFO
logs_file_name = /log/kpi_plugin.log
log_file_max_size = 10485760
log_file_backup_count = 5
```

11.22.3.6 Grafana Dashboard Templates

The KPI plugin provides several Grafana dashboard templates that the Grafana users can import, these dashboards display the KPIs panels and graphs. The main dashboard is a cluster view that shows the cluster's KPIs. The dashboard should be connected to the KPI Prometheus server.

The dashboard JSON template can be found under `/opt/ufm/files/conf/plugins/kpi/grafana/`:

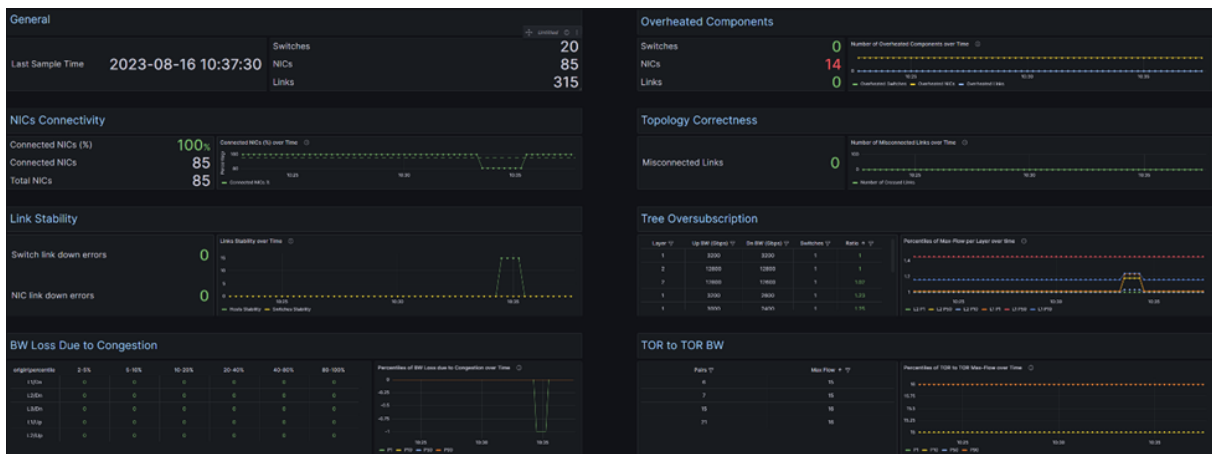

11.22.4 Logs

The following logs are exposed under `/opt/ufm/files/logs/plugins/kpi/` in case of UFM plugin mode, and under `/log` inside the container in case of Standalone mode.

- `kpi_plugin.log` - The application logs.
- `kpi_plugin_stderr/stdout` - The application service logs

- `prometheus.log` - The local Prometheus logs.

11.22.5 REST APIs

11.22.5.1 Get List of Configured Clusters

- URL:
 - UFM Plugin: `https://<IP>/ufmRest/plugin/kpi/api/cluster/__names__`
 - Standalone: `http://<IP>:8686/api/cluster/__names__`
- Method: GET
- Response: List of cluster names strings

11.22.5.2 Get KPIs Information

- URL:
 - UFM Plugin: `https://<IP>/ufmRest/plugin/kpi/files/kpi_info`
 - Standalone: `http://<IP>:8686/files/kpi_info`
- Method: GET
- Response: List of KPI names and HTML descriptions.

11.22.5.3 Get KPIs Values

- URL:
 - UFM Plugin: `https://<IP>/ufmRest/plugin/kpi/api/cluster/<cluster_name>`
 - Standalone: `http://<IP>:8686/api/cluster/<cluster_name>`
- Method: GET

Response: A list of KPIs with the relative calculates graph values to be used in the UI. Generally, 2 main components are expected: the table data (key “2d_matrix_data”) and the graph data (key “graph_data”). Each value corresponds to rules expected by the UI:

- `display name` - KPI display name
- `2d_matrix_data` - Latest data in a table-like format. Every list item is a dict that makes a table row - corresponding to the columns of that row.
 - `data` - List of dict, each dict is a column in the row. May contain:
 - `percentage` - Value in percentage.
 - `value` - Raw value.
 - `name` - Column header
 - `direction` - For arrows icon (up / down)
 - `name` - Row header
- `graph_data` - dictionary with the following items:
 - `multi_line_graph` - time series graph for one or more series.
 - `title` - Graph title.
 - `x_label` - X axis label.
 - `x_values` - X axis values.
 - `y_labels` - Y axis labels.
 - `y_values` - Y axis values.

- `info` - string with information of the graph data.

11.22.5.4 Get KPI Plugin Overview

- URL:
 - UFM Plugin: `https://<IP>/ufmRest/plugin/kpi/overview?time_window=<value>` (in hours)
 - Standalone: `http://<IP>:8686/overview?time_window=<value>` (in hours)
- Method: GET

Response:

```
{
  "clusters_telemetry_info": [
    {
      "cluster_name": "unknown",
      "interval": 60,
      "url": "http://pjazz:9002/csv/metrics"
    }
  ],
  "prometheus_info": {
    "db_statistics": {
      "appended_samples_rate_per_sec": 11.46,
      "bytes_rate_per_sample": 9.227,
      "total_compressed_blocks_size_bytes": 272329313.0,
      "total_head_chunks_size_bytes": 1937238.0,
      "total_wal_size_bytes": 2989807.0
    },
    "url": "http://pjazz:9191"
  }
}
```

Where:

`clusters_telemetry_info` : contains a list of the configured clusters' information, each cluster has the following properties:

Property	Description	Default Value
<code>cluster_name</code>	Cluster's name	One cluster with name 'unknown'
<code>interval</code>	Cluster's telemetry pulling time interval	60
<code>url</code>	The cluster's URL telemetry	http://0.0.0.0:9002/csv/metrics

`prometheus_info`: Contains the general Prometheus configurations (e.g. the URL) and statistics about the collected samples (for the local Prometheus mode)

Property	Description
<code>db_statistics.appended_samples_rate_per_sec</code>	Prometheus rate of the total appended samples per second, calculated by the following Prometheus expression: <code>rate(prometheus_tsdb_head_samples_appended_total[rate_window_time]h)</code>
<code>db_statistics.bytes_rate_per_sample</code>	Prometheus rate of ingested bytes per sample, calculated by the following Prometheus expression: <code>rate(prometheus_tsdb_compaction_chunk_size_bytes_sum[rate_window_time]h) / rate(prometheus_tsdb_compaction_chunk_samples_sum[rate_window_time]h)</code>

db_statistics. total_compressed_blocks_size_bytes	Total compressed blocks size in bytes that the Prometheus was stored, calculating by the following Prometheus expression: <i>prometheus_tsdb_storage_blocks_bytes</i>
db_statistics. total_head_chunks_size_bytes	Total HEAD chunks blocks size in bytes that the Prometheus was stored, calculating by the following Prometheus expression: <i>prometheus_tsdb_head_chunks_storage_size_bytes</i>
db_statistics.total_wal_size_bytes	Total WAL size bytes, calculating by the following Prometheus expression: <i>prometheus_tsdb_wal_storage_size_bytes</i>
prometheus_info.url	The promethues's URL telemetry

11.22.6 UI Views

11.22.6.1 KPI Overview

The screenshot displays the NVIDIA UFM Enterprise KPI Overview interface. On the left is a dark sidebar with the NVIDIA logo and 'UFM Enterprise' text, containing navigation icons for Dashboard, Network Map, Histogram View, Managed Elements, Events & Alarms, Telemetry, System Health, KPI, KPI Overview, and Cluster Data. The main content area is titled 'KPI Overview' and features two primary sections:

- Clusters Telemetry Information:** A table with columns for Cluster Name, Telemetry URL, and Scraping Interval. A single entry is visible: Cluster Name 'unknown', Telemetry URL 'http://pjazz:9002/csv/metrics', and Scraping Interval '60'. Below the table is a pagination control showing 'Viewing 1-1 of 1'.
- Prometheus Server Information:** A table displaying server metrics for a 'Rate Time Window' of 'Last 24 hours'. The metrics are:

Prometheus Address	http://pjazz:9191
Ingested Samples/sec	11.774 samples/s
Stored Bytes/Sample	9.228 B/sample
WAL Directory Size	1.81 MB
HEAD CHUNKS Directory Size	128 KB
Compressed Blocks Size	253.1 MB

11.22.6.2 Cluster KPIs Data

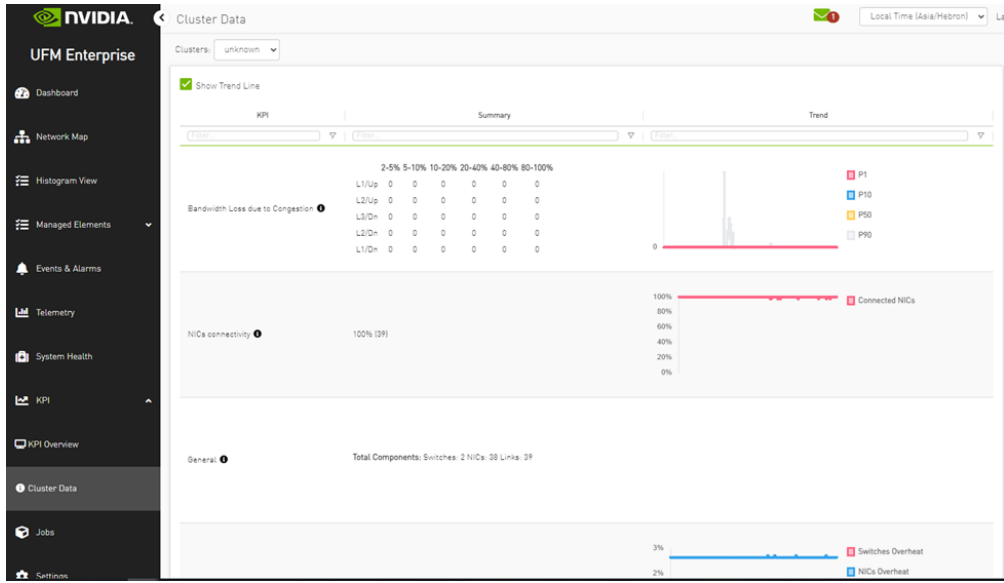

12 Troubleshooting

12.1 Split-Brain Recovery in HA Installation

The split-brain problem is a DRBD synchronization issue (HA status shows `DUnknown` in the DRBD disk state), which occurs when both HA nodes are rebooted. For example, in cases of electricity shut-down. To recover, please follow the below steps:

- Step 1: Manually choose a node where data modifications will be discarded.
It is called the split-brain victim. Choose wisely; all modifications will be lost! When in doubt, run a backup of the victim's data before you continue.
When running a Pacemaker cluster, you can enable maintenance mode. If the split-brain victim is in the Primary role, bring down all applications using this resource. Now switch the victim to the Secondary role:

```
victim# drbdadm secondary ha_data
```

- Step 2: Disconnect the resource if it's in connection state `WConnection`:

```
victim# drbdadm disconnect ha_data
```

- Step 3: Force discard of all modifications on the split-brain victim:

```
victim# drbdadm -- --discard-my-data connect ha_data
```

For DRBD 8.4.x:

```
victim# drbdadm connect --discard-my-data ha_data
```

- Step 4: Resync starts automatically if the survivor is in a `WConnection` network state. If the split-brain survivor is still in a `Standalone` connection state, reconnect it:

```
survivor# drbdadm connect ha_data
```

Now the resynchronization from the survivor (`SyncSource`) to the victim (`SyncTarget`) starts immediately. There is no full sync initiated, but all modifications on the victim will be overwritten by the survivor's data, and modifications on the survivor will be applied to the victim.

12.2 Performing Failover on Non-Master Node

The `ufm_ha_cluster failover` action fails with the following error: "Cannot perform failover on non-master node". To fix, follow the below action:

- Step 1: Verify that `/etc/hosts` file on both the master and standby UFM hosts contains the correct host names and IP addresses mapping.
- Step 2: If necessary, fix the mapping and retry the failover command.

12.3 Restoring UFM Data Upon In-Service Upgrade Failure

These instructions apply in high availability scenario only.

In the event of an in-service upgrade failure, the previous version of UFM's data will be safeguarded as a backup in the "`/opt/ufm/BACKUP`" directory, formatted as

"`ufm_upgrade_backup_<prev_version>-<new_version<_<date>.zip`."

To restore the data on the unupgraded node, follow these steps:

1. Copy the backup file from the upgraded node to the unupgraded node using the following command:

```
scp /opt/ufm/BACKUP/ufm_upgrade_backup_<prev_version>-<new_version<_<date>.zip root@<unupgraded_node_ip>:/opt/ufm/BACKUP/
```

2. Perform a failover of UFM to the master node, which is mandatory for data mount migration (including '`/opt/ufm/files`') to the master node: On the Master node, execute:

```
ufm_ha_cluster takeover
```

3. Stop UFM on the unupgraded node:

```
ufm_ha_cluster stop
```

4. Restore UFM configuration files from the backup:

```
/opt/ufm/scripts/ufm_restore.sh -f /opt/ufm/BACKUP/ufm_upgrade_backup_<prev_version>-<new_version<_<date>.zip
```

5. Start UFM on the unupgraded node (Note: Only the upgraded node can function until the upgrade issue is resolved, and failovers will not work).

Now, the issue that caused the upgrade failure can be addressed. If the problem is resolved, you can attempt the in-service upgrade again by failing UFM over to the upgraded node.

Alternatively, if needed, you can revert the changes made by reinstalling the old UFM version on the upgraded node.

13 Appendixes

- [SM Configurations](#)
- [Appendix - Diagnostic Utilities](#)
- [Appendix - Supported Port Counters and Events](#)
- [Appendix - Used Ports](#)
- [Appendix - Configuration Files Auditing](#)
- [Appendix - IB Router](#)
- [Appendix - NVIDIA SHARP Integration](#)
- [Appendix - UFM SLURM Integration](#)
- [Appendix - Switch Grouping](#)
- [Appendix - Device Management Feature Support](#)

13.1 SM Configurations

- [Appendix - SM Default Files](#)
- [Appendix - UFM Subnet Manager Default Properties](#)
- [Appendix - Partitioning](#)
- [Appendix - Enhanced Quality of Service](#)
- [Appendix - OpenSM Configuration Files for Congestion Control](#)
- [Appendix - Routing Chains](#)
- [Appendix - Adaptive Routing](#)
- [Appendix - Security Features](#)
- [Appendix - SM Activity Report](#)

13.1.1 Appendix - SM Default Files

The SM default files are located under the following paths:

- Default SM configuration file - /opt/ufm/files/conf/opensm/opensm.conf
- Default node name map file - /opt/ufm/files/conf/opensm/ib-node-name-map
- Default partition configuration file - /opt/ufm/files/conf/opensm/partitions.conf
- Default QOS policy configuration file - /opt/ufm/files/conf/opensm/qos-policy.conf
- Default prefix routes file - /opt/ufm/files/conf/opensm/prefix-routes.conf

13.1.2 Appendix - UFM Subnet Manager Default Properties

The following table provides a comprehensive list of UFM SM default properties.

Category	Property	Config File Attribute	Default	Mode / Field	Description
Generic	Subnet Prefix	subnet_prefix	0xfe80000000000000	RW	Subnet prefix used on the subnet 0xfe80000000000000

Category	Property	Config File Attribute	Default	Mode / Field	Description
	LMC	lmc	0	RW	The LMC value used on the subnet: 0-7 Changes to the LMC parameter require a UFM restart.
	SM LID	master_sm_lid	0		Force LID for local SM when in MASTER state Selected LID must match configured LMC 0 disables the feature
Keys	M_Key	m_key	0x0000000000000000	RW	M_Key value sent to all ports -used to qualify the set(PortInfo)
	M_Key Lease Period	m_key_lease_period	0	RW	The lease period used for the M_Key on the subnet in [sec]
	SM_Key	sm_key	0x0000000000000001	RO	SM_Key value of the SM used for SM authentication
	SA_Key	sa_key	0x0000000000000001	RO	SM_Key value to qualify rcv SA queries as 'trusted'
	Partition enforcement	part_enforce	<ul style="list-style-type: none"> • Out • In • Both (default-outbound and inbound enforcement enabled) 	RO	Partition enforcement type (for switches)
	MKEY lookup	m_key_lookup	FALSE	RW	If FALSE, SM will not try to determine the m_key of unknown ports.
	M_Key Per Port	m_key_per_port	FALSE	RW	When m_key_per_port is enabled, OpenSM will generate an M_Key for each port
Limits	Packet Life Time	packet_life_time	0x12	RW	The maximum lifetime of a packet in a switch. The actual time is $4.096\text{usec} * 2^{\langle \text{packet_life_time} \rangle}$ The value 0x14 disables the mechanism
	VL Stall Count	vl_stall_count	0x07	RO	The number of sequential packets dropped that cause the port to enter the VL Stalled state. The result of setting the count to zero is undefined.

Category	Property	Config File Attribute	Default	Mode / Field	Description
	Leaf VL Stall Count	leaf_vl_stall_count	0x07	RO	The number of sequential packets dropped that causes the port to enter the leaf VL Stalled state. The count is for switch ports driving a CA or gateway port. The result of setting the count to zero is undefined.
	Head Of Queue Life time	head_of_queue_lifetime	0x12	RW	The maximum time a packet can wait at the head of the transmission queue. The actual time is $4.096\text{usec} * 2^{\langle \text{head_of_queue_lifetime} \rangle}$ The value 0x14 disables the mechanism
	Leaf Head Of Queue Life time	leaf_head_of_queue_lifetime	0x10	RW	The maximum time a packet can wait at the head of queue on a switch port connected to a CA or gateway port.
	Maximal Operational VL	max_op_vls	2	RW	Limit of the maximum operational VLs
	Force Link Speed	force_link_speed	15 (Do NOT change)	RO	Force PortInfo: LinkSpeedEnabled on switch ports. If 0, do not modify. Values are: 1: 2.5 Gbps 3: 2.5 or 5.0 Gbps 5: 2.5 or 10.0 Gbps 7: 2.5 or 5.0 or 10.0 Gbps 2,4,6,8-14 Reserved 15: set to PortInfo: LinkSpeedSupported
Limits	Subnet Timeout	subnet_timeout	18 (1second)	RW	The subnet_timeout code that will be set for all the ports. The actual timeout is $4.096\text{usec} * 2^{\langle \text{subnet_timeout} \rangle}$
	Local PHY Error Threshold	local_phy_errors_threshold	0x08	RW	Threshold of local phy errors for sending Trap 129
	Overrun Errors Threshold	overrun_errors_threshold	0x08	RW	Threshold of credit overrun errors for sending Trap 130
Sweep	Sweep Interval	sweep_interval	10	RW	The time in seconds between subnet sweeps (Disabled if 0)
	Reassign Lids	reassign_lids	FALSE (disabled)	RW	If TRUE (enabled), all LIDs are reassigned

Category	Property	Config File Attribute	Default	Mode / Field	Description
	Force Heavy Sweep	force_heavy_sweep_window	-1	RW	Forces heavy sweep after number of light sweeps (-1 disables this option and 0 will cause every sweep to be heavy)
	Sweep On trap	sweep_on_trap	TRUE (enabled)	RW	If TRUE every trap 128 and 144 will cause a heavy sweep
	Alternative Route Calculation	max_alt_dr_path_retries	4	RW	Maximum number of attempts to find an alternative direct route towards unresponsive ports
	Fabric Rediscovery	max_seq_redisc	2	RW	Max Failed Sequential Discovery Loops
	Offsweep Rebalancing Enable	offsweep_balancing_enabled	FALSE	RW	Enable/Disable idle time routing rebalancing
	Offsweep Rebalancing Window	offsweep_balancing_window	180	RW	Set the time window in seconds after sweep to start rebalancing
Handover	SM Priority	sm_priority	15	RO	SM (enabled). The priority used for deciding which is the master. Range is 0 (lowest priority) to 15 (highest)
	Ignore Other SMs	ignore_other_sm	FALSE (disabled)	RO	If TRUE other SMs on the subnet should be ignored
	Polling Timeout	sminfo_polling_timeout	10	RO	Timeout in seconds between two active master SM polls
	Polling Retries	polling_retry_number	4	RO	Number of failing remote SM polls that declares it non-operational
	Honor GUID-to-LID File	honor_guid2lid_file	FALSE (disabled)	RO	If TRUE, honor the guid2lid file when coming out of standby state, if the guid2lid file exists and is valid
	Allowed SM GUID list	allowed_sm_guids	(null) (disabled)		List of Host GUIDs where SM is allowed to run when specified. OpenSM ignores SM running on port that is not in this list. If 0, does not allow any other SM. If null, the feature is disabled.
Threading	Max Wire SMPs	max_wire_smps	8	RW	Maximum number of SMPs sent in parallel
	Transaction Timeout	transaction_timeout	200	RO	The maximum time in [msec] allowed for a transaction to complete

Category	Property	Config File Attribute	Default	Mode / Field	Description
	Max Message FIFO Timeout	max_msg_fifo_timeout	10000	RO	Maximum time in [msec] a message can stay in the incoming message queue
	Routing Threads	routing_threads_num	0	RW	Number of threads to be used for parallel minhop/updn calculations. If 0, number of threads will be equal to number of processors.
	Routing Threads Per Core	max_threads_per_core	0	RW	Max number of threads that are allowed to run on the same processor during parallel computing. If 0, threads assignment per processor is up to operating system initial assignment.
Logging	Log File	log_file	/opt/ufm/files/log/opensm.log	RO	Path of Log file to be used
	Log Flags	log_flags	Error and Info 0x03	RW	The log flags, or debug level being used.
	Force Log Flush	force_log_flush	FALSE (disabled)	RO	Force flush of the log file after each log message
	Log Max Size	log_max_size	4096	RW	Limit the size of the log file in MB. If overrun, log is restarted
	Accumulate Log File	accum_log_file	TRUE (enabled)	RO	If TRUE, will accumulate the log over multiple OpenSM sessions
	Dump Files Directory	dump_files_dir	/opt/ufm/files/log	RO	The directory to hold the file SM dumps (for multicast forwarding tables for example). The file is used collects information.
	Syslog log	syslog_log	0x0	RW	Sets a verbosity of messages to be printed in syslog
Misc	Node Names Map File	node_name_map_name	Null	RW	Node name map for mapping node's to more descriptive node descriptions
	SA database File	sa_db_file	Null	RO	SA database file name
	No Clients Reregistration	no_clients_rereg	FALSE (disabled)	RO	If TRUE, disables client reregistration
	Exit On Fatal Event	exit_on_fatal	TRUE (enabled)	RO	If TRUE (enabled), the SM exits for fatal initialization issues

Category	Property	Config File Attribute	Default	Mode / Field	Description
	Switch Isolation From Routing	held_back_sw_file	Null	RW	File that contains GUIDs of switches isolated from routing
	Enable NVIDIA SHARP support	sharp_enabled	Enabled	RW	Defines whether to enable/disable NVIDIA SHARP on supporting ports.
Multicast	Disable Multicast	disable_multicast	FALSE (disabled)	RO	If TRUE, OpenSM should disable multicast support and no multicast routing is performed
	Multicast Group Parameters	default_mcg_mtu	0	RW	Default MC group MTU for dynamic group creation. 0 disables this feature, otherwise, the value is a valid IB encoded MTU
Multicast	Multicast Group Parameters	default_mcg_rate	0	RW	Default MC group rate for dynamic group creation. 0 disables this feature, otherwise, the value is a valid IB encoded rate
Multicast	Enable incremental multicast routing	enable_inc_mc_routing	FALSE	RW	Enable incremental multicast routing
Multicast	MC root file	mc_roots_file	null	RW	Specify predefined MC groups root guides
QoS	Settings	qos	FALSE (disabled) *From UFM v3.7 and on	RW	If FALSE (disabled), SM will not apply QoS settings
Unhealthy Ports	Enabling Unhealthy Ports	hm_unhealthy_ports_checks	TRUE	RW	Enables Unhealthy Ports configuration
	Configuration file	hm_ports_health_policy_file	null	RW	Specifies configuration file for health policy
	Unhealthy actions	hm_sw_manual_action	no_discover	RW	Specifies what to do with switch ports which were manually added to health policy file
	MADs validation	validate_smp	TRUE	RW	If set to TRUE, opensm will ignore nodes sending non-spec compliant MADs. When set to FALSE, opensm will log the warning in the opensm log file about non-compliant node

Category	Property	Config File Attribute	Default	Mode / Field	Description	
Routing	Unicast Routing Engine	routing_engine	(null)	RW	By default, ar_updn routing engine is used by the SM. Supported routing engines are minhop, updn, dnup, ftree, dor, torus-2QoS, kdor-hc, kdor-ghc, dfp, dfp2, ar_updn, ar_ftree and ar_dor.	
	Randomization	scatter_ports	8	RW	Assigns ports in a random order instead of round-robin. If 0, the feature is disabled, otherwise use the value as a random seed. Applicable to the MINHOP/UPDN routing algorithms	
	Randomization	guid_routing_order_no_scatter	TRUE	RO	Do not use scatter for ports defined in guid_routing_order file	
	Unicast Routing Caching	use_ucast_cache	TRUE	RW	Use unicast routing cache for routing computation time improvement	
	GUID Ordering During Routing	guid_routing_order_file	NULL	RW	The file holding guid routing order of particular guides (for MinHop, Up/Down)	
	Torus Routing	torus_config	/opt/ufm/files/conf/opensm/torus-2QoS.con	RW	Torus-2QoS configuration file name	
	Routing Chains		pgrp_policy_file	NULL	RW	The file holding the port groups policy
			topo_policy_file	NULL	RW	The file holding the topology policy
			rch_policy_file	NULL	RW	The file holding the routing chains policy
			max_topologies_per_sw	1	RO	Defines maximal number of topologies to which a single switch may be assigned during routing engine chain configuration.
	Incremental Multicast Routing (IMR)	enable_inc_mc_routing	TRUE	RW	If TRUE, MC nodes will be added to the MC tree incrementally. When set to FALSE, the tree will be recalculated per each change.	
	MC Global root	mc_primary_root_guid/ mc_secondary_root_guid	0x0000000000000000 00 (for both)	RW	Primary and Secondary global mc root guid	
	Scatter ports	use_scatter_for_switch_lid	FALSE	RW	Use scatter when routing to the switch's LIDs	

Category	Property	Config File Attribute	Default	Mode / Field	Description
	updn lid tracking mode	updn_lid_tracking_mode	FALSE	RW	Controls whether SM will use LID tracking or not when updn or ar_updn routing engine is used
Events	Event Subscription Handling	drop_subscr_on_report_fail	FALSE	RW	Drop subscription on report failure (o13-17.2.1)
	Event Subscription Handling	drop_event_subscriptions	TRUE	RW	Drop event subscriptions (InformInfo and ServiceRecords) on port removal and SM coming out of STANDBY
Virtualization	Virtualization enabled	virt_enabled	Enabled	RW	Enables/disables virtualization support
	Maximum ports in virtualization process	virt_max_ports_in_process	64	RW	Sets a number of ports to be handled on each virtualization process cycle
Router	Router aguid enable	rtr_aguid_enable	0 (Disabled)	RW	Defines whether the SM should create alias GUIDs required for router support for each HCA port
	Router path record flow label	rtr_pr_flow_label	0	RW	Defines flow label value to use in multi-subnet path query responses
	Router path record tclass	rtr_pr_tclass	0	RW	Defines tclass value to use in multi-subnet path query responses.
	Router path record sl	rtr_pr_sl	0	RW	Defines sl value to use in multi-subnet path query responses
	Router path record MTU	rtr_pr_mtu	4 (IB_MTU_LEN_2048)	RW	Define MTU value to use in multi-subnet path query responses
	Router path record rate	rtr_pr_rate	16 (IB_PATH_RECORD_RATE_100_GBS)	RW	Defines rate value to use in multi-subnet path query responses
SA Security	SA Enhanced Trust Model (SAETM)	sa_enhanced_trust_model	FALSE	RW	Controls whether SAETM is enabled.

Category	Property	Config File Attribute	Default	Mode / Field	Description
	Untrusted GuidInfo records	sa_etm_allow_untrusted_guidinfo_rec	FALSE	RW	Controls whether to allow Untrusted Guidinfo record requests in SAETM.
	Guidinfo record requests by VF	sa_etm_allow_guidinfo_rec_by_vf	FALSE	RW	Controls whether to allow Guidinfo record requests by vf in SAETM.
	Untrusted proxy requests	sa_etm_allow_untrusted_proxy_requests	FALSE	RW	Controls whether to allow Untrusted proxy requests in SAETM.
	Max number of multicast groups	sa_etm_max_num_mcgs	128	RW	Max number of multicast groups per port/vport that can be registered.
	Max number of service records	sa_etm_max_num_srvcs	32	RW	Max number of service records per port/vport that can be registered.
	Max number of event subscriptions	sa_etm_max_num_event_subs	32	RW	Max number of event subscriptions (InformInfo) per port/vport that can be registered.
	SGID spoofing	sa_check_sgid_spoofing	TRUE	RW	If enabled, the SA checks for SGID spoofing in every request with GRH included, unless the SLID is from a router port at that request.

13.1.2.1 Configuring UFM for SR-IOV

Single-root I/O virtualization (SR-IOV) enables a PCI Express (PCIe) device to appear to be multiple separate physical PCIe devices.

UFM is ready to work with SR-IOV devices by default. You can fine-tune the configuration using the SM configuration.

The following arguments are available for ConnectX-5 and later devices:

Argument	Value	Description
virt_enabled	<ul style="list-style-type: none"> 0 - no virtualization support 1 - disable virtualization on all virtualization supporting ports 2 - enable virtualization on all virtualization supporting ports (default) 	Virtualization support

Argument	Value	Description
virt_max_ports_in_process	Possible values: 0-65535; where 0 processes all pending ports Default: 64	Maximum number of ports to be processed simultaneously by the virtualization manager
virt_default_hop_limit	Possible values: 0-255 Default: 2	Default value for hop limit to be returned in path records where either the source or destination are virtual ports

13.1.2.2 Isolating Switch From Routing

UFM can isolate particular switches from routing in order to perform maintenance of the switches with minimal interruption to the existing traffic in the fabric.

Isolating a switch from routing is done via UFM Subnet Manager as follows:

1. Create a file that includes either the node GUIDs or system GUID of the switches under maintenance. For example:

```
0x1234566
0x1234567
```

2. Set the filename of the parameter held_back_sw_file in the /conf/opensm.conf file (the same as the file created in Step 1).
3. Run:

```
kill -s HUP 'pidof opensm'
```

Once SM completes rerouting, the traffic does not go through the ports of isolated switches.

To attach the switch to the routing:

1. Remove the GUID of the switch from the list of isolated switches defined in Step 1 of the isolation process.
2. Run:

```
kill -s HUP 'pidof opensm'
```

Once SM completes rerouting, traffic will go through the switch.

13.1.3 Appendix - Partitioning

Partitioning enforces isolation of the fabric. The default partition is created on all managed devices. Devices that are running an SM, all switches, routers, and gateways are added to the default partition with full membership. By default, all the HCA ports are also added to the default partition with FULL membership.

Partitioning is provisioned to the Subnet Manager via the partitions.conf configuration file, which cannot be removed or manually modified.

For those who use NVIDIA gateway systems, for proper system functionality, disable the automatic partitioning by changing the attribute `gateway_port_partitioning = none` in the `/opt/ufm/files/conf/gv.cfg` configuration. Restart UFM for the change to take effect.

If required, you can add an extension to the `partitions.conf` file that is generated by UFM. You can edit the file, `/opt/ufm/files/conf/partitions.conf.user_ext`, and the content of this extension file will be added to the `partitions.conf` file. Files synchronization is done by UFM on every logical model change. However, it can also be triggered manually by running the `/opt/ufm/scripts/sync_partitions_conf.sh` script. The script validates and merges the `/opt/ufm/files/conf/partitions.conf.user_ext` file into the `/opt/ufm/files/conf/opensm/partitions.conf` file and starts the heavy sweep on the Subnet Manager.

The maximum length of the line in the `partitions.conf` file is 4096 characters. However, to enable long PKeys, it is possible to split the pkey membership to multiple lines:

```
IOPartition=0x4, ipoib, sl=0, defmember=full : <port-guid1> , <port-guid2> ;  
IOPartition=0x4, ipoib, sl=0, defmember=full : <port-guid3> , <port-guid4> ;
```

The `partitions.conf.user_ext` uses the same format as the `partitions.conf` file. See [SM Partitions.conf File Format](#) for the format of the `partitions.conf` file.

For example, to add server ports to PKey 4:

```
IOPartition=0x4, ipoib, sl=0, defmember=full : 0x8f10001072a41;
```

13.1.3.1 SM Partitions.conf File Format

This appendix presents the content and format of the SM `partitions.conf` file.

```
OpenSM Partition configuration  
=====  
  
The default partition will be created by OpenSM unconditionally even  
when partition configuration file does not exist or cannot be accessed.  
  
The default partition has P_Key value 0x7fff. OpenSM's port will always  
have full membership in default partition. All other end ports will have  
full membership if the partition configuration file is not found or cannot  
be accessed, or limited membership if the file exists and can be accessed  
but there is no rule for the Default partition.  
  
Effectively, this amounts to the same as if one of the following rules  
below appear in the partition configuration file:  
In the case of no rule for the Default partition:  
Default=0x7fff : ALL=limited, SELF=full ;  
In the case of no partition configuration file or file cannot be accessed:  
Default=0x7fff : ALL=full ;  
  
File Format  
=====  
  
Comments:  
  
Line content followed after \'#\'' character is comment and ignored by  
parser.  
  
General file format:  
  
<Partition Definition>:[<newline>]<Partition Properties>;  
  
Partition Definition:  
[PartitionName][=PKey][,ipoib_bc_flags][,defmember=full|limited]  
  
PartitionName - string, will be used with logging. When omitted  
empty string will be used.  
PKey - P_Key value for this partition. Only low 15 bits will  
be used. When omitted will be autogenerated.
```

```

ipoib_bc_flags - used to indicate/specify IPoIB capability of this partition.
defmember=full|limited - specifies default membership for port guid
list. Default is limited.

ipoib_bc_flags:
ipoib_flag[mgroup_flag]*

ipoib_flag - indicates that this partition may be used for IPoIB, as
a result the IPoIB broadcast group will be created with
the flags given, if any.

Partition Properties:
[<Port list>|<MCast Group>]* | <Port list>

Port list:
<Port Specifier>[,<Port Specifier>]

Port Specifier:
<PortGUID>[=[full|limited]]

PortGUID - GUID of partition member EndPort. Hexadecimal
numbers should start from 0x, decimal numbers
are accepted too.

full or limited - indicates full or limited membership for this
port. When omitted (or unrecognized) limited
membership is assumed.

MCast Group:
mgid=gid[,mgroup_flag]*<newline>

- gid specified is verified to be a Multicast address
IP groups are verified to match the rate and mtu of the
broadcast group. The P_Key bits of the mgid for IP
groups are verified to either match the P_Key specified
in by "Partition Definition" or if they are 0x0000 the
P_Key will be copied into those bits.

mgroup_flag:
rate=<val> - specifies rate for this MC group
            (default is 3 (10Gbps))
mtu=<val> - specifies MTU for this MC group
            (default is 4 (2048))
sl=<val> - specifies SL for this MC group
            (default is 0)
scope=<val> - specifies scope for this MC group
            (default is 2 (link local)). Multiple scope settings
            are permitted for a partition.
NOTE: This overwrites the scope nibble of the specified
mgid. Furthermore specifying multiple scope
settings will result in multiple MC groups
being created.
qkey=<val> - specifies the Q_Key for this MC group
            (default: 0x0b1b for IP groups, 0 for other groups)
            WARNING: changing this for the broadcast group may
            break IPoIB on client nodes!!!
tclass=<val> - specifies tclass for this MC group
            (default is 0)
FlowLabel=<val> - specifies FlowLabel for this MC group
            (default is 0)

newline: '\n'

```

Note that values for rate, mtu, and scope, for both partitions and multicast groups, should be specified as defined in the IBTA specification (for example, mtu=4 for 2048).

There are several useful keywords for PortGUID definition:

- 'ALL' means all end ports in this subnet.
- 'ALL_CAS' means all Channel Adapter end ports in this subnet.
- 'ALL_SWITCHES' means all Switch end ports in this subnet.
- 'ALL_ROUTERS' means all Router end ports in this subnet.
- 'SELF' means subnet manager's port.

Empty list means no ports in this partition.

Notes:

White space is permitted between delimiters ('=', ',', ':', ';').

PartitionName does not need to be unique, PKey does need to be unique.
If PKey is repeated then those partition configurations will be merged
and first PartitionName will be used (see also next note).

It is possible to split partition configuration in more than one
definition, but then PKey should be explicitly specified (otherwise
different PKey values will be generated for those definitions).

Examples:

```

-----
Default=0x7fff : ALL, SELF=full ;
Default=0x7fff : ALL, ALL_SWITCHES=full, SELF=full ;

NewPartition , ipoib : 0x123456=full, 0x3456789034=limited, 0x2134af2306 ;

YetAnotherOne = 0x300 : SELF=full ;
YetAnotherOne = 0x300 : ALL=limited ;

```

```

ShareIO = 0x80 , defmember=full : 0x123451, 0x123452;
# 0x123453, 0x123454 will be limited
ShareIO = 0x80 : 0x123453, 0x123454, 0x123455=full;
# 0x123456, 0x123457 will be limited
ShareIO = 0x80 : defmember=limited : 0x123456, 0x123457, 0x123458=full;
ShareIO = 0x80 , defmember=full : 0x123459, 0x12345a;
ShareIO = 0x80 , defmember=full : 0x12345b, 0x12345c=limited, 0x12345d;

# multicast groups added to default
Default=0x7fff,ipoib:
  mgid=ff12:401b:0707,s1=1 # random IPv4 group
  mgid=ff12:601b:16 # MLDv2-capable routers
  mgid=ff12:401b:16 # IGMP
  mgid=ff12:601b:2 # All routers
  mgid=ff12:1,s1=1,Q_Key=0xDEADBEEF,rate=3,mtu=2 # random group
  ALL=full;

Note:
----

The following rule is equivalent to how OpenSM used to run prior to the
partition manager:

Default=0x7fff,ipoib:ALL=full;

```

13.1.4 Appendix - Enhanced Quality of Service

Enhanced QoS provides a higher resolution of QoS at the service level (SL). Users can configure rate limit values per SL for physical ports, virtual ports, and port groups, using `enhanced_qos_policy_file` configuration parameter.

Valid values of this parameter:

- Full path to the policy file through which Enhanced QoS Manager is configured
- “null” - to disable the Enhanced QoS Manager (default value)

To enable Enhanced QoS Manager, QoS must be enabled in SM configuration file.

13.1.4.1 Enhanced QoS Policy File

The policy file is comprised of two sections:

- **BW_NAMES:** Used to define bandwidth setting and name (currently, rate limit is the only setting). Bandwidth names are defined using the syntax:

```
<name> = <rate limit in 1Mbps units>
```

Example:

```
My_bandwidth = 50
```

- **BW_RULES:** Used to define the rules that map the bandwidth setting to a specific SL of a specific GUID. Bandwidth rules are defined using the syntax:

```
<guid>|<port group name> = <sl id>:<bandwidth name>, <sl id>:<bandwidth name>...
```

Examples:

```
0x2c90000000025 = 5:My_bandwidth, 7:My_bandwidth
Port_grp1 = 3:My_bandwidth, 9:My_bandwidth
```

13.1.4.1.1 Notes

- Rate limit = 0 represents unlimited rate limit.
- Any unspecified SL in a rule will be set to 0 (unlimited) rate limit automatically.
- “default” is a well-known name which can be used to define a default rule used for any GUID with no defined rule (If no default rule is defined, any GUID without a specific rule will be configured with unlimited rate limit for all SLs).
- Failure to complete policy file parsing leads to an undefined behavior. User must confirm no relevant error messages in SM log in order to ensure Enhanced QoS Manager is configured properly.
- An empty file with only ‘BW_NAMES’ and ‘BW_RULES’ keywords configures the network with an unlimited rate limit.
- The VPORT_BW_RULES section is optional and includes virtual port GUIDs only (including the vport0 GUID). Physical port GUIDs added to this section are treated as vport0 GUIDs.

13.1.4.1.2 Policy File Example

The below is an example of configuring all ports in the fabric with rate limit of 50Mbps on SL1, except for GUID 0x2c90000000025, which is configured with rate limit of 100Mbps on SL1. In this example, all SLs (other than SL1) are unlimited.

```
-----  
BW_NAMES  
bw1 = 50  
bw2 = 100  
BW_RULES  
default: 1:bw1  
0x2c90000000025: 1:bw2  
-----  
VPORT_BW_RULES  
default = all:DEF_BW_2
```

13.1.5 Appendix - OpenSM Configuration Files for Congestion Control

13.1.5.1 OpenSM Configuration

13.1.5.1.1 Enabling Congestion Control

In order to enable congestion control, set the parameter `mlnx_congestion_control` in the OpenSM configuration file to 2. For example:

```
mlnx_congestion_control 2
```

To disable congestion control, set the parameter value to 1. For example:

```
mlnx_congestion_control 1
```

13.1.5.1.2 Defining a Congestion Control Policy File

To define a congestion control policy file, set the parameter `congestion_control_file` in OpenSM configuration file to point to congestion control policy file. For example:

```
congestion_control_policy_file /opt/ufm/files/conf/opensm/conf/congestion_control_policy_file
```

The file includes a reference to an active algorithm file name. The algorithm file has to be inside the `ppcc_algo_dir`.

For Example:

```
ca_algo_import_start
  algo_start
    algo_id:1
    algo_file_name: active_algo_file_name
    # PPCC parameter by name, as defined in algo profile
    parameters: (BW_G,400), (ALPHA,3932), (MAX_DEC,63569), (MAX_INC,69468), (AI,36), (HAI,1200)
  algo_end
ca_algo_import_end
```

The `ca_algo_import` block contains all the algo blocks that map an `algo_id` to an algorithm profile file. The `algo_id` field of the algo blocks must be unique and start from 1. This block is used to import the various PCC algorithms into the configuration and associate them with their `algo_id` values.

13.1.5.1.3 Defining a directory for PPCC algorithm profiles

To define a directory for the programmable congestion control algorithm profiles, set the parameter `ppcc_algo_dir` in OpenSM configuration file. For Example:

```
ppcc_algo_dir /opt/ufm/files/conf/opensm/conf/ppcc_algo_dir
```

13.1.6 Appendix - Routing Chains

The routing chains feature is offering a solution that enables one to configure different parts of the fabric and define a different routing engine to route each of them. The routings are done in a sequence (hence the name "chains") and any node in the fabric that is configured in more than one part is left with the last routing engine updated for it.

13.1.6.1 Configuring Routing Chains

The configuration for the routing chains feature consists of the following steps:

1. Define the port groups.
2. Define topologies based on previously defined port groups.
3. Define configuration files for each routing engine.
4. Define routing engine chains over defined topologies.

13.1.6.1.1 Defining Port Groups

The basic idea behind the port groups is the ability to divide the fabric into sub-groups and give each group an identifier that can be used to relate to all nodes in this group. The port groups are used to define the participants in each of the routing algorithms.

13.1.6.1.2 Defining Port Group Policy File

In order to define a port group policy file, set the parameter 'pgrp_policy_file' in the opensm configuration file, as follows:

```
/opt/ufm/files/conf/opensm/port_groups_policy_file.conf
```

13.1.6.1.3 Configuring Port Group Policy

The port groups policy file details the port groups in the fabric. The policy file should be composed of one or more paragraphs that define a group. Each paragraph should begin with the line 'port-group' and end with the line 'end-port-group'.

For example:

```
port-group
...port group qualifiers...
end-port-group
```

13.1.6.1.4 Port Group Qualifiers

Unlike the port group's beginning and ending which do not require a colon, all qualifiers must end with a colon (':'). Also - a colon is a predefined mark that must not be used inside qualifier values. An inclusion of a colon in the name or the use of a port group, will result in the policy's failure.

13.1.6.1.4.1 Table 62: Port Group Qualifiers

Parameter	Description	Example
name	Each group must have a name. Without a name qualifier, the policy fails.	name: grp1
use	'use' is an optional qualifier that one can define in order to describe the usage of this port group (if undefined, an empty string is used as a default).	use: first port group

13.1.6.1.5 Rule Qualifiers

There are several qualifiers used to describe a rule that determines which ports will be added to the group. Each port group may contain one or more rules of the rule qualifiers in Table 63 (at least one rule shall be defined for each port group).

13.1.6.1.5.1 Table 63: Rule Qualifiers

Parameter	Description	Example
guid list	<p>Comma separated list of guides to include in the group.</p> <p>If no specific physical ports were configured, all physical ports of the guid are chosen. However, for each guid, one can detail specific physical ports to be included in the group. This can be done using the following syntax:</p> <ul style="list-style-type: none"> Specify a specific port in a guid to be chosen port-guid: 0x283@3 Specify a specific list of ports in a guid to be chosen port-guid: 0x286@1/5/7 Specify a specific range of ports in a guid to be chosen port-guid: 0x289@2-5 Specify a list of specific ports and ports ranges in a guid to be chosen port-guid: 0x289@2-5/7/9-13/18 Complex rule port-guid: 0x283@5-8/12/14, 0x286, 0x289/6/8/12 	port-guid: 0x283, 0x286, 0x289
port guid range	<p>It is possible to configure a range of guides to be chosen to the group. However, while using the range qualifier, it is impossible to detail specific physical ports.</p> <p>Note: A list of ranges cannot be specified. The below example is invalid and will cause the policy to fail: port-guid-range: 0x283-0x289, 0x290-0x295</p>	port-guid-range: 0x283-0x289
port name	<p>One can configure a list of hostnames as a rule. Hosts with a node description that is built out of these hostnames will be chosen. Since the node description contains the network card index as well, one might also specify a network card index and a physical port to be chosen. For example, the given configuration will cause only physical port 2 of a host with the node description 'kuku HCA-1' to be chosen.</p> <p>port and hca_idx parameters are optional. If the port is unspecified, all physical ports are chosen. If hca_idx is unspecified, all card numbers are chosen. Specifying a hostname is mandatory. One can configure a list of hostname/port/hca_idx sets in the same qualifier as follows: port-name: hostname=kuku; port=2; hca_idx=1 , hostname=host1; port=3, hostname=host2</p> <p>Note: port-name qualifier is not relevant for switches, but for HCA's only.</p>	port-name: hostname=kuku; port=2; hca_idx=1
port regexp	One can define a regular expression so that only nodes with a matching node description will be chosen to the group	port-regexp: SW.*

Parameter	Description	Example
	It is possible to specify one physical port to be chosen for matching nodes (there is no option to define a list or a range of ports). The given example will cause only nodes that match physical port 3 to be added to the group.	port-regexp: SW.*:3
union rule	It is possible to define a rule that unites two different port groups. This means that all ports from both groups will be included in the united group.	union-rule: grp1, grp2
subtract rule	One can define a rule that subtracts one port group from another. The given rule, for example, will cause all the ports which are a part of grp1, but not included in grp2, to be chosen. In subtraction (unlike union), the order does matter, since the purpose is to subtract the second group from the first one. There is no option to define more than two groups for union/subtraction. However, one can unite/ subtract groups which are a union or a subtraction themselves, as shown in the port groups policy file example.	subtract-rule: grp1, grp2

13.1.6.1.6 Predefined Port Groups

There are 3 predefined port groups that are available for use, yet cannot be defined in the policy file (if a group in the policy is configured with the name of one of these predefined groups, the policy fails) -

- ALL - a group that includes all nodes in the fabric
- ALL_SWITCHES - a group that includes all switches in the fabric.
- ALL_CAS - a group that includes all HCA's in the fabric.

13.1.6.1.7 Port Groups Policy Examples

```
port-group
name: grp3
use: Subtract of groups grp1 and grp2
subtract-rule: grp1, grp2
end-port-group

port-group
name: grp1
port-guid: 0x281, 0x282, 0x283
end-port-group

port-group
name: grp2
port-guid-range: 0x282-0x286
port-name: hostname=server1 port=1
end-port-group

port-group
name: grp4
port-name: hostname=kika port=1 hca_idx=1
end-port-group

port-group
name: grp3
union-rule: grp3, grp4
end-port-group
```

13.1.6.2 Defining Topologies Policy File

In order to define a port group policy file, set the parameter 'topo_policy_file' in the opensm configuration file.

```
/opt/ufm/files/conf/opensm/topo_policy_file.conf
```

13.1.6.2.1 Configuring Topology Policy

The topologies policy file details a list of topologies. The policy file should be composed of one or more paragraphs which define a topology. Each paragraph should begin with the line 'topology' and end with the line 'end-topology'.

For example:

```
topology
...topology qualifiers...
end-topology
```

13.1.6.2.2 Topology Qualifiers

Unlike topology and end-topology which do not require a colon, all qualifiers must end with a colon (':'). Also - a colon is a predefined mark that must not be used inside qualifier values. An inclusion of a column in the qualifier values will result in the policy's failure.

All topology qualifiers are mandatory. Absence of any of the below qualifiers will cause the policy parsing to fail.

Parameter	Description	Example
id	Topology ID. Legal Values - any positive value. Must be unique.	id: 1
sw-grp	Name of the port group that includes all switches and switch ports to be used in this topology.	sw-grp: some_switches
hca-grp	Name of the port group that includes all HCA's to be used in this topology.	hca-grp: some_hosts

13.1.6.3 Configuration File per Routing Engine

Each engine in the routing chain can be provided by its own configuration file. Routing engine configuration file is the fraction of parameters defined in the main opensm configuration file.

Some rules should be applied when defining a particular configuration file for a routing engine:

- Parameters that are not specified in specific routing engine configuration file are inherited from the main opensm configuration file.
- The following configuration parameters are taking effect only in the main opensm configuration file:

- qos and qos_* settings like (vl_arb, sl2vl, etc.)
- lmc
- routing_engine

13.1.6.3.1 Defining Routing Chain Policy File

In order to define a port group policy file, set the parameter 'rch_policy_file' in the opensm configuration file, as follows:

```
/opt/ufm/files/conf/opensm/routing_chains_policy.conf
```

13.1.6.3.2 First Routing Engine in Chain

The first unicast engine in a routing chain must include all switches and HCA's in the fabric (topology id must be 0). The path-bit parameter value is path-bit 0 and it cannot be changed.

13.1.6.3.3 Configuring Routing Chains Policy

The routing chains policy file details the routing engines (and their fallback engines) used for the fabric's routing. The policy file should be composed of one or more paragraphs which defines an engine (or a fallback engine). Each paragraph should begin with the line 'unicast-step' and end with the line 'end-unicast-step'.

For example:

```
unicast-step
...routing engine qualifiers...
end-unicast-step
```

13.1.6.3.4 Routing Engine Qualifiers

Unlike unicast-step and end-unicast-step which do not require a colon, all qualifiers must end with a colon (':'). Also - a colon is a predefined mark that must not be used inside qualifier values. An inclusion of a colon in the qualifier values will result in the policy's failure.

Parameter	Description	Example
id	<p>'id' is mandatory. Without an id qualifier for each engine, the policy fails.</p> <ul style="list-style-type: none"> • Legal values - size_t value (0 is illegal). • The engines in the policy chain are set according to an ascending id order, so it is highly crucial to verify that the id that is given to the engines match the order in which you would like the engines to be set. 	is: 1

Parameter	Description	Example
engine	This is a mandatory qualifier that describes the routing algorithm used within this unicast step. Currently, on the first phase of routing chains, legal values are minhop/ftree/updn.	engine: minhop
use	This is an optional qualifier that enables one to describe the usage of this unicast step. If undefined, an empty string is used as a default.	use: ftree routing for cluster 1
config	This is an optional qualifier that enables one to define a separate opensm config file for a specific unicast step. If undefined, all parameters are taken from main opensm configuration file.	config: /etc/config/ opensm2.cfg
topology	Define the topology that this engine uses. <ul style="list-style-type: none"> • Legal value - id of an existing topology that is defined in topologies policy (or zero that represents the entire fabric and not a specific topology). • Default value - If unspecified, a routing engine will relate to the entire fabric (as if topology zero was defined). • Notice: The first routing engine (the engine with the lowest id) MUST be configured with topology: 0 (entire fabric) or else, the routing chain algorithm will fail. 	topology: 1
fallback-to	This is an optional qualifier that enables one to define the current unicast step as a fallback to another unicast step. This can be done by defining the id of the unicast step that this step is a fallback to. <ul style="list-style-type: none"> • If undefined, the current unicast step is not a fallback. • If the value of this qualifier is a non-existent engine id, this step will be ignored. • A fallback step is meaningless if the step it is a fallback to did not fail. • It is impossible to define a fallback to a fallback step (such definition will be ignored) 	-
path-bit	This is an optional qualifier that enables one to define a specific lid offset to be used by the current unicast step. Setting lmc > 0 in main opensm configuration file is a prerequisite for assigning specific path-bit for the routing engine. Default value is 0 (if path-bit is not specified)	Path-bit: 1

13.1.6.3.5 Dump Files per Routing Engine

Each routing engine on the chain will dump its own data files if the appropriate log_flags is set (for instance 0x43).

- The files that are dumped by each engine are:
 - opensm-lid-matrix.dump
 - opensm-lfts.dump
 - opensm.fdb

- opensm-subnet.lst

These files should contain the relevant data for each engine topology.

sl2vl and mcfdbs files are dumped only once for the entire fabric and NOT by every routing engine.

- Each engine concatenates its ID and routing algorithm name in its dump files names, as follows:
 - opensm-lid-matrix.2.minhop.dump
 - opensm.fdfs.3.ftree
 - opensm-subnet.4.updn.lst
- If a fallback routing engine is used, both the routing engine that failed and the fallback engine that replaces it, dump their data.

If, for example, engine 2 runs ftree and it has a fallback engine with 3 as its id that runs minhop, one should expect to find 2 sets of dump files, one for each engine:

- opensm-lid-matrix.2.ftree.dump
- opensm-lid-matrix.3.minhop.dump
- opensm.fdfs.2.ftree
- opensm.fdfs.3.minhop

13.1.7 Appendix - Adaptive Routing

As of UFM v6.4, Adaptive Routing plugin is no longer required for Adaptive Routing and SHIELD configuration. AR is now part of the core Subnet Manager implementation. However, upgrading UFM to v6.4 from an earlier version using the AR plugin will remain possible.

For information on how to set up AR and SHIELD, please refer to [How-To Configure Adaptive Routing and Self Healing Networking](#).

13.1.8 Appendix - Security Features

13.1.8.1 SA Enhanced Trust Model (SAETM)

Standard SA has a concept of trust-based requests on the SA_Key that is part of each SA MAD. A trusted request is when the SA_Key value is not equal to zero but equals the SA configured value, while an untrusted request is when the SA_Key value equals zero in the request. If a request has a non-zero SA_Key value that is different from the configured SA key, it will be dropped and reported.

When SAETM is enabled, the SA limits the set of untrusted requests allowed. Untrusted requests that are not allowed according to SAETM will be silently dropped (for the set of untrusted requests allowed, see [the following section](#) below).

SAETM feature is disabled by default. To enable it, set the sa_enhanced_trust_model parameter to TRUE.

Additional SAETM Configuration Parameters

Parameter	Description
sa_etm_allow_untrusted_guidinfo_rec	Defines whether to allow GUIDInfoRecord as part of the SAETM set of untrusted requests allowed (see section below)
sa_etm_allow_guidinfo_rec_by_vf	Defines whether to drop GUIDInfoRecord from non-physical ports (see section below)
sa_etm_allow_untrusted_proxy_requests	Defines the behavior for proxy requests (see section below)
sa_etm_max_num_mcgs/ sa_etm_max_num_srvcs/ sa_etm_max_num_event_subs	Defines the registration limits in SAETM (see section below)

13.1.8.1.1 Set of Untrusted SA Requests Allowed

The following table lists the untrusted requests allowed when SAETM is enabled:

Request	Request Type
MCMemberRecord	Get/Set/Delete
PathRecord	Get
PathRecord	GetTable (only if both destination and source are specified (e.g. only point to point))
ServiceRecord	Get/Set/Delete
ClassPortInfo	Get
InformInfo	Set (for non-SM security traps)
GUIDInfoRecord	Set/Delete - this request can only be part of this set depending on the values of sa_etm_allow_untrusted_guidinfo_rec and sa_etm_allow_guidinfo_rec_by_vf - see elaboration below.

When sa_etm_allow_untrusted_guidinfo_rec is set to FALSE (and SAETM is enabled), the SA will drop GUIDInfoRecord Set/Delete untrusted requests.

When sa_etm_allow_guidinfo_rec_by_vf is set to FALSE (and SAETM is enabled), the SA will drop GUIDInfoRecord Set/Delete requests from non-physical ports.

If sa_etm_allow_untrusted_guidinfo_rec=FALSE, GUIDInfoRecord Set/Delete requests will become part of the SAETM set of untrusted requests allowed. Note that if sa_etm_allow_guidinfo_rec_by_vf=FALSE, the requests will only be allowed from physical ports.

13.1.8.1.2 Proxy SA Requests

SA modification request (SET/DELETE) is identified as a proxy operation when the port corresponding with the requester source address (SLID from LRH/SGID from GRH) is different than the port for which the request applies:

- For MCMemberRecord, when the MCMemberRecord.PortGID field does not match the requester address
- For ServiceRecord, when the ServiceRecord.ServiceGID field does not match requester address

- For the GUIDInfoRecord, when the LID field in the RID of the record does not match the requester address

When sa_etm_allow_untrusted_proxy_requests is set to FALSE and SAETM is enabled, untrusted proxy requests will be dropped.

13.1.8.1.3 Registration Limits

When any of sa_etm_max_num_mcgs, sa_etm_max_num_srvcs or sa_etm_max_num_event_subs parameters is set to 0, the number of this parameter's registrations can be unlimited. When the parameter's value is different than 0, attempting to exceed the maximum number of registrations will result in the request being silently dropped. Consequently, the requester and request info will be logged, and an event will be generated for the Activity Manager.

The following parameters control the maximum number of registrations:

Parameter	Description
sa_etm_max_num_mcgs	Maximum number of multicast groups per port/vport that can be registered.
sa_etm_max_num_srvcs	Maximum number of service records per port/vport that can be registered.
sa_etm_max_num_event_subs	Maximum number of event subscriptions (InformInfo) per port/vport that can be registered.

13.1.8.1.4 SAETM Logging

When requesting an operation that is not part of the SAETM set of untrusted requests, it will be silently dropped and eventually written to the SM log.

The logging of the dropped MADs is repressed to not overload the OpenSM log. If the request that needs to be dropped was received from the same requester many times consecutively, OpenSM logs it only if the request number is part of the following sequence:

0, 1, 2, 5, 10, 20, 50, 100, 200... (similar to the trap log repression).

13.1.8.2 SGID Spoofing

SA can validate requester addresses by comparing the SLID and SGID of the incoming request. SA determines the requester port by the SLID and SGID field of the request. SGID spoofing is when the SGID and SLID do not match.

When sa_check_sgid_spoofing parameter is enabled, SA checks for SGID spoofing in every request that includes GRH, unless the SLID belongs to a router port in that same request. In case the request SGID does not match its SLID, the request will be dropped. The default value of this parameter is TRUE.

13.1.8.3 M_Key Authentication

13.1.8.3.1 M_Key Per Port

This feature increases protection on the fabric as a unique M_Key is generated and set for each HCA, router, or switch port.

OpenSM calculates an M_Key per port by performing a hash function on the port GUID of the device and the M_Key configured in opensm.conf.

To enable M_Key per port, set the parameter below in addition to the parameters listed in the [previous section](#):

```
m_key_per_port TRUE
```

13.1.9 Appendix - SM Activity Report

SM can produce an activity report in a form of a dump file that details the different activities done in the SM. Activities are divided into subjects. The table below specifies the different activities currently supported in the SM activity report.

Reporting of each subject can be enabled individually using the configuration parameter `activity_report_subjects`:

- Valid values:

Comma-separated list of subjects to dump. The current supported subjects are:

- "mc" - activity IDs 1, 2 and 8
- "prtn" - activity IDs 3, 4, and 5
- "virt" - activity IDs 6 and 7
- "routing" - activity IDs 8-12

Two predefined values can be configured as well:

- "all" - dump all subjects
- "none" - disable the feature by dumping none of the subjects
- Default value: "none"

13.1.9.1 SM Supported Activities

Activity ID	Activity Name	Additional Fields	Comments	Description
1	mcm_member	- MLid - MGid - Port Guid - Join State	Join state: 1 - Join -1 - Leave	Member joined/left MC group
2	mcb_change	- MLid - MGid - Change	Change: 0 - Create 1 - Delete	MC group created/ deleted
3	prtn_guid_add	- Port Guid - PKey - Block index - Pkey Index		Guid added to partition

Activity ID	Activity Name	Additional Fields	Comments	Description
4	prtn_create	- PKey - Prtn Name		Partition created
5	prtn_delete	- PKey - Delete Reason	Delete Reason: 0 - empty prtn 1 - duplicate prtn 2 - sm shutdown	Partition deleted
6	port_virt_discover	- Port Guid - Top Index		Port virtualization discovered
7	vport_state_change	- Port Guid - VPort Guid - VPort Index - VNode Guid - VPort State	VPort State: 1 - Down 2 - Init 3 - ARMED 4 - Active	Vport state changed
8	mcg_tree_calc	- mlid		MCast group tree calculated
9	routing_succeed	routing engine name		Routing done successfully
10	routing_failed	routing engine name		Routing failed
11	ucast_cache_invalidated			ucast cache invalidated
12	ucast_cache_routing_done			ucast cache routing done

13.2 Appendix - Diagnostic Utilities

For UFM-SDN Appliance, all the below diagnostics commands have ib prefix.

For example, for UFM-SDN Appliance, the command `ibstat` is `ib ibstat`.

13.2.1 InfiniBand Diagnostics Commands

Command	Description
ibstat	Shows the host adapters status.
ibstatus	Similar to ibstat but implemented as a script.
ibnetdiscover	Scans the topology.
ibaddr	Shows the LID range and default GID of the target (default is the local port).
ibroute	Displays unicast and multicast forwarding tables of the switches.
ibtracert	Displays unicast or multicast route from source to destination.
ibping	Uses vendor MADs to validate connectivity between InfiniBand nodes. On exit, (IP) ping-like output is shown.

Command	Description
ibsysstat	Obtains basic information for the specific node which may be remote. This information includes: hostname, CPUs, memory utilization.
sminfo	Queries the SMInfo attribute on a node.
smpdump	A general purpose SMP utility which gets SM attributes from a specified SMA. The result is dumped in hex by default.
smpquery	Enables a basic subset of standard SMP queries including the following: node info, node description, switch info, port info. Fields are displayed in human readable format.
perfquery	Dumps (and optionally clears) the performance counters of the destination port (including error counters).
ibswitches	Scans the net or uses existing net topology file and lists all switches.
ibhosts	Scans the net or uses existing net topology file and lists all hosts.
ibnodes	Scans the net or uses existing net topology file and lists all nodes.
ibportstate	Gets the logical and physical port states of an InfiniBand port or disables or enables the port (only on a switch). Note: This tool can change port settings. Should be used with caution.
saquery	Issues SA queries.
ibdiagnet	ibdiagnet scans the fabric using directed route packets and extracts all the available information regarding its connectivity and devices.
ibnetsplit	Automatically groups hosts and creates scripts that can be run to split the network into sub-networks each containing one group of hosts.
lbqueryerrors	Queries IB spec-defined errors from all fabric ports. Note: This tool can change reset port counters Should be used with caution.
smparquery	Queries adaptive-routing related settings from a particular switch. Note: This tool can change reset port counters Should be used with caution.

13.2.2 Diagnostic Tools

Model of operation: All utilities use direct MAD access to operate. Operations that require QP 0 mads only, may use direct routed mads, and therefore may work even in subnets that are not configured. Almost all utilities can operate without accessing the SM, unless GUID to lid translation is required.

13.2.2.1 Dependencies

Multiple port/Multiple CA support:

When no InfiniBand device or port is specified (as shown in the following example for "Local umad parameters"), the tools select the interface port to use by the following criteria:

1. The first InfiniBand ACTIVE port.
2. If not found, the first InfiniBand port that is UP (physical link up).

If a port and/or CA name is specified, the tool attempts to fulfill the user's request and will fail if it is not possible.

For example:

```
ibaddr      # use the 'best port'
ibaddr -C mthcal      # pick the best port from mthcal only.
ibaddr -P 2           # use the second (active/up) port from the first available IB device.
ibaddr -C mthca0 -P 2 # use the specified port only.
```

Common Options & Flags

Most diagnostics take the following flags. The exact list of supported flags per utility can be found in the usage message and can be shown using `util_name -h` syntax.

```
# Debugging flags
-d      raise the IB debugging level. May be used several times (-ddd or -d -d -d).
-e      show umad send receive errors (timeouts and others)
-h      show the usage message
-v      increase the application verbosity level.
        May be used several times (-vv or -v -v -v)
-V      show the internal version info.
```

```
# Addressing flags
-D      use directed path address arguments.
        The path is a comma separated list of out ports.
        Examples:
        "0"      # self port
        "0,1,2,1,4" # out via port 1, then 2, ...
-G      use GUID address arguments.
        In most cases, it is the Port GUID.
        Examples:
        "0x08f1040023"
-s <smlid> use 'smlid' as the target lid for SA queries.
```

```
# Local umad parameters:
-C <ca_name>      use the specified ca_name.
-P <ca_port>      use the specified ca_port.
-t <timeout_ms>  override the default timeout for the
                 solicited mads.
```

CLI notation: all utilities use the POSIX style notation, meaning that all options (flags) must precede all arguments (parameters).

13.2.3 Utilities Descriptions

ibstatus

A script that displays basic information obtained from the local InfiniBand driver. Output includes LID, SMLID, port state, link width active, and port physical state.

Syntax

```
ibstatus [-h] [devname[:port]]
```

Examples:

```
ibstatus          # display status of all IB ports
ibstatus mthcal   # status of mthcal ports
ibstatus mthcal:1 mthca0:2 # show status of specified ports
```

See also: `ibstat`

`ibstat`

Similar to the `ibstatus` utility but implemented as a binary and not as a script. Includes options to list CAs and/or ports.

Syntax

```
ibstat [-d(debug) -l(list_of_cas) -p(port_list) -s(hort)] <ca_name> [portnum]
```

Examples:

```
ibstat          # display status of all IB ports
ibstat mthca1   # status of mthca1 ports
ibstat mthca1 2 # show status of specified ports
ibstat -p mthca0 # list the port guides of mthca0
ibstat -l      # list all CA names
```

See also: `ibstatus`

ibroute

Uses SMPs to display the forwarding tables (unicast (LinearForwardingTable or LFT) or multicast (MulticastForwardingTable or MFT)) for the specified switch LID and the optional lid (mlid) range. The default range is all valid entries in the range 1...FDBTop.

Syntax

```
ibroute [options] <switch_addr> [<startlid> [<endlid>]]
```

Nonstandard flags:

```
-a          show all lids in range, even invalid entries.
-n          do not try to resolve destinations.
-M          show multicast forwarding tables. In this case the range
node-name-map parameters are specifying mlid range.
node name map file
```

Examples:

```
ibroute 2          # dump all valid entries of switch lid 2
ibroute 2 15       # dump entries in the range 15...FDBTop.
ibroute -a 2 10 20 # dump all entries in the range 10..20
ibroute -n 2       # simple format
ibroute -M 2       # show multicast tables
```

See also: `ibtracert`

ibtracert

Uses SMPs to trace the path from a source GID/LID to a destination GID/LID. Each hop along the path is displayed until the destination is reached or a hop does not respond. By using the `-m` option, multicast path tracing can be performed between source and destination nodes.

Syntax

```
ibtracert [options] <src-addr> <dest-addr>
```

Nonstandard flags:

```
-n          simple format; don't show additional information.
-m <mlid>  show the multicast trace of the specified mlid.
-f <force> force
node-name-map node name map file
```

Examples:

```
ibtracert 2 23          # show trace between lid 2 and 23
ibtracert -m 0xc000 3 5 # show multicast trace between lid 3
and 5 for mcast lid 0xc000.
```

smpquery

Enables a basic subset of standard SMP queries including the following node info, node description, switch info, port info. Fields are displayed in human readable format.

Syntax

```
smpquery [options] <op> <dest_addr> [op_params]
```

Currently supported operations and their parameters:

```
nodeinfo <addr>
nodedesc <addr>
portinfo <addr> [<portnum>] # default port is zero
switchinfo <addr>
pkeys <addr> [<portnum>]
sl2vl <addr> [<portnum>]
vlarb <addr> [<portnum>]
GUIDInfo (GI) <addr>
MlnxExtPortInfo (MEPI) <addr> [<portnum>]
Combined (-c) : use Combined route address argument
node-name-map : node name map file
extended (-x) : use extended speeds
```

Examples:

```
smpquery nodeinfo 2          # show nodeinfo for lid 2
smpquery portinfo 2 5       # show portinfo for lid 2 port 5
```

smpdump

A general purpose SMP utility that gets SM attributes from a specified SMA. The result is dumped in hex by default.

Syntax

```
smpdump [options] <dest_addr> <attr> [mod]
```

Nonstandard flags:

```
-s          show output as string
```

Examples:

```
smpdump -D 0,1,2 0x15 2     # port info, port 2
smpdump 3 0x15 2           # port info, lid 3 port 2
```

ibaddr

Can be used to show the LID and GUID addresses of the specified port or the local port by default. This utility can be used as simple address resolver.

Syntax

```
ibaddr [options] [<dest_addr>]
```

Nonstandard flags:

```
gid_show (-g) : show gid address only  
lid_show (-l) : show lid range only  
Lid_show (-L) : show lid range (in decimal) only
```

Examples:

```
ibaddr          # show local address  
ibaddr 2       # show address of the specified port lid  
ibaddr -G 0x8f1040023 # show address of the specified port guid
```

sminfo

Issues and dumps the output of an sminfo query in human readable format. The target SM is the one listed in the local port info or the SM specified by the optional SM LID or by the SM direct routed path.

CAUTION: Using sminfo for any purpose other than a simple query might result in a malfunction of the target SM.

Syntax

```
sminfo [options] <sm_lid|sm_dr_path> [sminfo_modifier]
```

Nonstandard flags:

```
-s <state>      # use the specified state in sminfo mad  
-p <priority>   # use the specified priority in sminfo mad  
-a <activity>  # use the specified activity in sminfo mad
```

Examples:

```
sminfo          # show sminfo of SM listed in local portinfo  
sminfo 2       # query SM on port lid 2
```

perfquery

Uses PerfMgt GMPs to obtain the PortCounters (basic performance and error counters) from the Performance Management Agent (PMA) at the node specified. Optionally show aggregated counters for all ports of node. Also, optionally, reset after read, or only reset counters.

```
perfquery [options] [<lid|guid> [[port] [reset_mask]]]
```

Nonstandard flags:

```
-a                Shows aggregated counters for all ports of the destination lid.
-r                Resets counters after read.
-R                Resets only counters.
Extended (-x)    Shows extended port counters
Xmtsl (-X)       Shows Xmt SL port counters
Rcvsl ,(-S)      Shows Rcv SL port counters
Xmtdisc (-D)     Shows Xmt Discard Details
rcvrr, (-E)      Shows Rcv Error Details
extended_speeds (-T) Shows port extended speeds counters
oprcvcounters    Shows Rcv Counters per Op code
flowctlcounters Shows flow control counters
vloppackets      Shows packets received per Op code per VL
vlopdata         Shows data received per Op code per VL
vlxmitflowctlerrors Shows flow control update errors per VL
vlxmitcounters   Shows ticks waiting to transmit counters per VL
swportvlcong     Shows sw port VL congestion
rcvcc            Shows Rcv congestion control counters
slrcvfebn        Shows SL Rcv FECN counters
slrcvbecn        Shows SL Rcv BECN counters
xmitcc           Shows Xmit congestion control counters
vlxmittlecc      Shows VL Xmit Time congestion control counters
smplctl (-c)     Shows samples control
loop_ports (-l)  Iterates through each port
```

Examples:

```
perfquery          # read local port's performance counters
perfquery 32 1      # read performance counters from lid 32, port 1
perfquery -a 32     # read from lid 32 aggregated performance counters
perfquery -r 32 1   # read performance counters from lid 32 port 1 and reset
perfquery -R 32 1   # reset performance counters of lid 32 port 1 only
perfquery -R -a 32  # reset performance counters of all lid 32 ports
perfquery -R 32 2 0xf000 # reset only non-error counters of lid 32 port 2
```

ibping

Uses vendor mads to validate connectivity between InfiniBand nodes. On exit, (IP) ping like output is show. `ibping` is run as client/server. The default is to run as client. Note also that a default ping server is implemented within the kernel.

Syntax

```
ibping [options] <dest lid|guid>
```

Nonstandard flags:

```
-c <count>        stop after count packets
-f                flood destination: send packets back to back w/o delay
-o <oui>           use specified OUI number to multiplex vendor MADs
-S                start in server mode (do not return)
```

ibnetdiscover

Performs InfiniBand subnet discovery and outputs a human readable topology file. GUIDs, node types, and port numbers are displayed as well as port LIDs and node descriptions. All nodes (and links) are displayed (full topology). This utility can also be used to list the current connected nodes. The output is printed to the standard output unless a topology file is specified.

Syntax

```
ibnetdiscover [options] [<topology-filename>]
```

Nonstandard flags:

```
l  Lists connected nodes
H  Lists connected HCAs
S  Lists connected switches
```



```

g Groups
full (-f) Shows full information (ports' speed and width, vlcap)
show (-s) Shows more information
Router_list (-R) Lists connected routers
node-name-map Nodes name map file
cache filename to cache ibnetdiscover data to
load-cache filename of ibnetdiscover cache to load
diff filename of ibnetdiscover cache to diff
diffcheck Specifies checks to execute for --diff
ports : (-p) Obtains a ports report
max_hops (-m) Reports max hops discovered by the library
outstanding_smps (-o) Specifies the number of outstanding SMP's which should be issued during the scan

```

ibhosts

Traces the InfiniBand subnet topology or uses an already saved topology file to extract the CA nodes.

Syntax

```
ibhosts [-h] [<topology-file>]
```

Dependencies: ibnetdiscover, ibnetdiscover format

ibswitches

Traces the InfiniBand subnet topology or uses an already saved topology file to extract the InfiniBand switches.

Syntax

```
ibswitches [-h] [<topology-file>]
```

Dependencies: ibnetdiscover, ibnetdiscover format

ibportstate

Enables the port state and port physical state of an InfiniBand port to be queried or a switch port to be disabled or enabled.

Syntax

```

ibportstate [-d(ebug) -e(rr_show) -v(erbose) -D(irect) -G(uid) -s smlid -V(ersion) -C ca_name -P ca_port -t
timeout_ms] <dest dr_path|lid|guid> <portnum> [<op>]

```

Supported ops: enable, disable, query, on, off, reset, speed, espeed, fdr10, width, down, arm, active, vls, mtu, lid, smlid, lmc, mkey, mkeylease, mkeyprot

Examples:

```

ibportstate 3 1 disable # by lid
ibportstate -G 0x2C9000100D051 1 enable # by guid
ibportstate -D 0 1 # by direct route

```

ibnodes

Uses the current InfiniBand subnet topology or an already saved topology file and extracts the InfiniBand nodes (CAs and switches).

Syntax

```
ibnodes [<topology-file>]
```

Dependencies: ibnetdiscover, ibnetdiscover format

ibqueryerrors

Queries or clears the PMA error counters in PortCounters by walking the InfiniBand subnet topology.

```
ibqueryerrors [options]
```

Syntax

```
Options:
--suppress, -s <err1,err2,...>  suppress errors listed
--suppress-common, -c           suppress some of the common counters
--node-name-map <file>         node name map file
--port-guid, -G <port_guid>    report the node containing the port
                                specified by <port_guid>
--, -S <port_guid>             Same as "-G" for backward compatibility
--Direct, -D <dr_path>         report the node containing the port specified
                                by <dr_path>
--skip-sl                       don't obtain SL to all destinations
--report-port, -r              report port link information
--threshold-file <val>         specify an alternate threshold file, default: /etc/infiniband-diags/error_thresholds
                                (This option is obsolete and does nothing)
--GNDN, -R                     include data counters for ports with errors
--data                           print data for switches only
--switch                         print data for CA's only
--ca                             print data for routers only
--router                         include transmit discard details
--details                        print data counters only
--counters                       Clear error counters after read
--clear-errors, -k             Clear data counters after read
--clear-counts, -K            filename of ibnetdiscover cache to load
--load-cache <file>           --outstanding_smps, -o <val> specify the number of outstanding SMP's
                                which should be issued during the scan
--config, -z <config>         use config file, default: /etc/infiniband-diags/ibdiag.conf
--Ca, -C <ca>                 Ca name to use
--Port, -P <port>             Ca port number to use
--timeout, -t <ms>            timeout in ms
--m_key, -y <key>             M_Key to use in request
--errors, -e                   show send and receive errors
--verbose, -v                  increase verbosity level
--debug, -d                    raise debug level
--help, -h                     help message
--version, -V                  show version
```

smparquery

Issues Adaptive routing-related queries to the fabric switch.

Syntax

```
Supported ops (and aliases, case insensitive):
ARInfo (ARI) <addr>
ARGroupTable (ARGT) <addr> [<plft>] [<group_table>] [<blocknum>]
ARLPTTable (ARLT) <addr> [<plft>] [<blocknum>]
PLFTInfo (PLFTI) <addr>
PLFTDef (PLFTD) <addr> [<blocknum>]
PLFTMap (PLFTM) <addr> [<plft>] [<control_map>]
PortSLToPLFTMap (PLFTP) <addr> [<blocknum>]
RNSubGroupDirectionTable (DIRT) <addr> [<blocknum>]
RNGenStringTable (GSTR) <addr> [<plft>] [<blocknum>]
RNGenBySubGroupPriority (GSGP) <addr>
RNRevString (RSTR) <addr> [<blocknum>]
RNXmitPortMask (RNXM) <addr> [<blocknum>]
PortRNCounters (RNPC) <addr>
```

```
Options:
Main
-C|--Ca <ca>                  : Ca name to use
-P|--Port <port>              : Ca port number to use
-D|--Direct                    : use Direct address argument
-L|--Lid                       : use LID address argument
-h|--help                     : help message
-V|--version                   : show version
-d|--debug                     : Print debug logs
```

saquery

Issues SA queries.

Syntax

```
saquery [-h -d -P -N -L -G -s -g][<name>]
```

Queries node records by default.

d	Enables debugging
P	Gets PathRecord info
N	Gets NodeRecord info
L (-L)	Returns just the Lid of the name specified
G (-G)	Returns just the Guid of the name specified
S (-S)	Returns the PortInfoRecords with isSM capability mask bit on
G (-g)	Gets multicast group info
L (-l)	Returns the unique Lid of the name specified
O (-O)	Returns name for the Lid specified
m(-m)	Gets multicast member info (if multicast group specified, list member GIDs only for group specified for example 'saquery -m 0xC000')
x (-x)	Gets LinkRecord info"
c (-c)	Gets the SA's class port info
S (-S)	Gets ServiceRecord info
I (-I)	Gets InformInfoRecord (subscription) info
list (-D)	the node desc of the CA's
src-to-dst (<src:dst>)	Gets a PathRecord for <src:dst> where src and dst are either node names or LIDs
sgid-to-dgid (<sgid-dgid>)	Gets a PathRecord for <sgid-dgid> where sgid and dgid are addresses in IPv6 format
node-name-map	Specifies a node name map file
smkey <val>	SA SM_Key value for the query. If non-numeric value (like 'x') is specified then saquery will prompt for a value. Default (when not specified here or in ibdiag.conf) is to use SM_Key == 0 (or \"untrusted\")
slid <lid>	Source LID (PathRecord)
dlid <lid>	Destination LID (PathRecord)
mild <lid>	Multicast LID (MCMemberRecord)
sgid <gid>	Source GID (IPv6 format) (PathRecord)
dgid <gid>	Destination GID (IPv6 format) (PathRecord)
gid <gid>	Port GID (MCMemberRecord)
mgid <gid>	Multicast GID (MCMemberRecord)
Reversible", 'r', 1, NULL"	Reversible path (PathRecord)
numb_path ", 'n', 1, NULL"	Number of paths (PathRecord)
pkey: P_Key (PathRecord, MCMemberRecord) .	QoS Class (PathRecord)
qos_class (-Q)	Service level (PathRecord, MCMemberRecord)
sl	MTU and selector (PathRecord, MCMemberRecord)
mtu : (-M)	Rate and selector (PathRecord, MCMemberRecord)
rate (-R)	Packet lifetime and selector (PathRecord, MCMemberRecord)
pkt_lifetime	If non-numeric value (like 'x') is specified then saquery will prompt for a value.
qkey (-q) (PathRecord, MCMemberRecord) .	Traffic Class (PathRecord, MCMemberRecord)
tclass (-T)	Flow Label (PathRecord, MCMemberRecord)
flow_label : (-F)	Hop limit (PathRecord, MCMemberRecord)
hop_limit : (-H)	Scope (MCMemberRecord)
scope	Join state (MCMemberRecord)
join_state (-J)	Proxy join (MCMemberRecord)
proxy_join (-X)	ServiceID (PathRecord)
service_id	

Dependencies: OpenSM libvendor, OpenSM libopensm, libibumad

ibsysstat

```
ibsysstat [options] <dest lid|guid> [<op>]
```

Nonstandard flags:

```
Current supported operations:
```

```
ping - verify connectivity to server (default)
host - obtain host information from server
cpu - obtain cpu information from server
-o <oui> use specified OUI number to multiplex vendor mads
-S start in server mode (do not return)
```

ibnetsplit

Automatically groups hosts and creates scripts that can be run in order to split the network into sub-networks containing one group of hosts.

Syntax

- **Group:**

```
ibnetsplit [-v][-h][-g grp-file] -s <.lst|.net|.topo> <-r head-ports|-d max-dist>
```

- **Split:**

```
ibnetsplit [-v][-h][-g grp-file] -s <.lst|.net|.topo>
-o out-dir
```

- **Combined:**

```
ibnetsplit [-v][-h][-g grp-file] -s <.lst|.net|.topo> <-r head-ports|-d max-dist> -o out-dir
```

Usage

- **Grouping:**

The grouping is performed if the -r or -d options are provided.

- If the -r is provided with a file containing group head ports, the algorithm examines the hosts distance from the set of node ports provided in the head-ports file (these are expected to be the ports running standby SM's).
- If the -d is provided with a maximum distance of the hosts in each group, the algorithm partition the hosts by that distance.

This method of analyzation may not be suitable for some topologies.

The results of the identified groups are printed into the file defined by the -g option (default ibnetsplit.groups) and can be manually edited. For groups where the head port is a switch, the group file uses the FIRST host port as the port to run the isolation script from.

- **Splitting:**

- If the -o flag is included, this algorithm analyzes the MinHop table of the topology and identifies the set of links and switches that may potentially be used for routing each group ports. The cross-switch links between switches of the group to other switches are declared as split-links and the commands to turn them off using Directed Routes from the original Group Head ports are written into the out-dir provided by the -o flag.

Both stages require a subnet definition file to be provided by the -s flag. The supported formats for subnet definition are:

- *.net - for ibnetdiscover
- *.lst - for opensm-subnet.lst or ibiagnet.lst
- *.topo - for a topology file

HEAD PORTS FILE

This file is provided by the user and defines the ports by which grouping of the other host ports is defined.

Format:

Each line should contain either the name or the GUID of a single port. For switches the port number shall be 0.

```
<node-name>/P<port-num>|<PGUID>
```

GROUPS FILE

This file is generated by the program if the head-ports file is provided to it. Alternatively it can be provided (or edited) by the user if different grouping is desired. The generated script for isolating or connecting the group should be run from the first node in each group.

Format:

Each line may be either:

```
GROUP: <group name>  
<node-name>/P<port-num>|<PGUID>
```

ibdiagnet

ibdiagnet scans the fabric using directed route packets and extracts all the available information regarding its connectivity and devices.

It then produces the following files in the output directory (see below):

- "ibdiagnet2.log" - A log file with detailed information.
- "ibdiagnet2.db_csv" - A dump of the internal tool database.
- "ibdiagnet2.lst" - A list of all the nodes, ports and links in the fabric.
- "[ibdiagnet2.pm](#)" - A dump of all the nodes PM counters.
- "ibdiagnet2.mlnx_cntrs" - A dump of all the nodes Mellanox diagnostic counters.
- "ibdiagnet2.net_dump" - A dump of all the links and their features.
- "ibdiagnet2.pkey" - A list of all pkeys found in the fabric.
- "ibdiagnet2.aguid" - A list of all alias GUIDs found in the fabric.
- "[ibdiagnet2.sm](#)" - A dump of all the SM (state and priority) in the fabric.
- "ibdiagnet2.fdfs" - A dump of unicast forwarding tables of the fabric switches.
- "ibdiagnet2.mcfdfs" - A dump of multicast forwarding tables of the fabric switches.
- "ibdiagnet2.slvl" - A dump of SLVL tables of the fabric switches.
- "ibdiagnet2.nodes_info" - A dump of all the nodes vendor specific general information for nodes who supports it.
- "ibdiagnet2.plft" - A dump of Private LFT Mapping of the fabric switches.
- "[ibdiagnet2.ar](#)" - A dump of Adaptive Routing configuration of the fabric switches.
- "ibdiagnet2.vl2vl" - A dump of VL to VL configuration of the fabric switches.

Load plugins from:

```
/tmp/ibutils2/share/ibdiagnet2.1.1/plugins/
```

You can specify additional paths to be looked in with "IBDIAGNET_PLUGINS_PATH" env variable.

Plugin Name	Result	Comment
libibdiagnet_cable_diag_plugin-2.1.1	Succeeded	Plugin loaded
libibdiagnet_phy_diag_plugin-2.1.1	Succeeded	Plugin loaded

Syntax

```
[-i|--device <dev-name>] [-p|--port <port-num>]
[-g|--guid <GUID in hex>] [--skip <stage>]
[--skip_plugin <library name>] [--sc]
[--scr] [--pc] [-P|--counter <<PM>=<value>>]
[--pm_pause_time <seconds>] [--ber_test]
[--ber_thresh <value>] [--llr_active_cell <64|128>]
[--extended_speeds <dev-type>] [--pm_per_lane]
[--ls <2.5|5|10|14|25|FDR10|EDR20>]
[--lw <1x|4x|8x|12x>] [--screen_num_errs <num>]
[--smp_window <num>] [--gmp_window <num>]
[--max_hops <max-hops>] [--read_capability <file name>]
[--write_capability <file name>]
[--back_compat_db <version.sub_version>]
[-V|--version] [-h|--help] [-H|--deep_help]
[--virtual] [--mads_timeout <mads-timeout>]
[--mads_retries <mads-retries>] [-m|--map <map-file>]
[--vlr <file>] [-r|--routing] [--r_opt <[vs,][mcast,]>]
[--sa_dump <file>] [-u|--fat_tree]
[--scope <file.guid>] [--exclude_scope <file.guid>]
[-w|--write_topo_file <file name>]
[-t|--topo_file <files>] [--out_ibnl_dir <directory>]
[-o|--output_path <directory>]
Cable Diagnostic (Plugin)
[--get_cable_info] [--cable_info_disconnected]
Phy Diagnostic (Plugin)
[--get_phy_info] [--reset_phy_info]
```

Options

```
-i|--device <dev-name>      : Specifies the name of the device of the port
                             used to connect to the IB fabric (in case
                             of multiple devices on the local system).
-p|--port <port-num>       : Specifies the local device's port number
                             used to connect to the IB fabric.
-g|--guid <GUID in hex>    : Specifies the local port GUID value of the
                             port used to connect to the IB fabric. If
                             GUID given is 0 then ibdiagnet displays
                             a list of possible port GUIDs and waits
                             for user input.
--skip <stage>             : Skip the executions of the given stage.
                             Applicable skip stages (vs_cap_smp
                             vs_cap_gmp | links | pm |
                             speed_width_check | all).
--skip_plugin <library name> : Skip the load of the given library name.
                             Applicable skip plugins:
                             (libibdiagnet_cable_diag_plugin-2.1.1 |
                             libibdiagnet_phy_diag_plugin-2.1.1).
--sc                        : Provides a report of Mellanox counters
--scr                       : Reset all the Mellanox counters (if --sc
                             option selected).
--pc                        : Reset all the fabric PM counters.
-P|--counter <<PM>=<value>> : If any of the provided PM is greater than
                             its provided value then print it.
--pm_pause_time <seconds>  : Specifies the seconds to wait between
                             first counters sample and second counters
                             sample. If seconds given is 0 then no
                             second counters sample will be done.
                             (default=1).
--ber_test                  : Provides a BER test for each port.
                             Calculate BER for each port and check no
                             BER value has exceeded the BER threshold.
                             (default threshold="10^-12").
--ber_thresh <value>       : Specifies the threshold value for the
                             BER test. The reciprocal number of the
                             BER should be provided. Example: for
                             10^-12 then value need to be
                             1000000000000 or 0xe8d4a51000
                             (10^12). If threshold given is 0 then all
                             BER values for all ports will be
                             reported.
--llr_active_cell <64|128> : Specifies the LLR active cell size
                             for BER test, when LLR is active in the
                             fabric.
--extended_speeds <dev-type> : Collect and test port extended speeds
                             counters. dev-type: (sw | all).
--pm_per_lane               : List all counters per lane (when
                             available).
--ls <0|2.5|5|10|14|25|50|100|FDR10> : Specifies the expected link speed.
--lw <1x|4x|8x|12x>         : Specifies the expected link width.
--screen_num_errs <num>    : Specifies the threshold for printing
                             errors to screen. (default=5).
--smp_window <num>         : Max smp MADs on wire. (default=8).
--gmp_window <num>         : Max gmp MADs on wire. (default=128).
--max_hops <max-hops>     : Specifies the maximum hops for the
                             discovery process. (default=64).
--read_capability <file name> : Specifies capability masks
                             configuration file, giving capability
                             mask configuration for the fabric.
                             ibdiagnet will use this mapping for
```

```

--write_capability <file name>      : Vendor Specific MADs sending.
                                     : Write out an example file for
                                     : capability masks configuration,
                                     : and also the default capability
                                     : masks for some devices.
--back_compat_db <version.sub_version> : Show ports section in
                                     : "ibdiagnet2.db_csv" according to
                                     : given version. Default version 2.0.
-V|--version                          : Prints the version of the tool.
-h|--help                              : Prints help information (without
                                     : plugins help if exists).
-H|--deep_help                         : Prints deep help information
                                     : (including plugins help).
--virtual                              : Discover VPorts during discovery
                                     : stage.
--mads_timeout <mads-timeout>         : Specifies the timeout (in
                                     : milliseconds) for sent and received
                                     : mads. (default=500).
--mads_retries <mads-retries>         : Specifies the number of retries for
                                     : every timeout mad. (default=2).
-m|--map <map-file>                  : Specifies mapping file, that maps
                                     : node guid to name
                                     : (format: 0x[0-9a-fA-F]+ "name").
                                     : Mapping file can also be specified by
                                     : Environment variable
                                     : "IBUTILS_NODE_NAME_MAP_FILE_PATH".
--src_lid <src-lid>                  : source lid
--dest_lid <dest-lid>                 : destination lid
--dr_path <dr-path>                   : direct route path
-o|--output_path <directory>         : Specifies the directory where the
                                     : Output files will be placed.
                                     : (default="/var/tmp/ibdiagpath/").

Cable Diagnostic (Plugin)
--get_cable_info                      : Indicates to query all QSFP cables
                                     : for cable information. Cable
                                     : information will be stored
                                     : in "ibdiagnet2.cables".
--cable_info_disconnected            : Get cable info on disconnected
                                     : ports.

Phy Diagnostic (Plugin)
--get_phy_info                        : Indicates to query all ports for phy
                                     : information.
--reset_phy_info                     : Indicates to clear all ports phy
                                     : information.

```

Cable Diagnostic (Plugin):

This plugin performs cable diagnostic. It can collect cable info (vendor, PN, OUI etc..) on each valid QSFP cable, if specified.

It produces the following files in the output directory (see below):

- "ibdiagnet2.cables" - In case specified to collect cable info, this file will contain all collected cable info.

Phy Diagnostic (Plugin)

This plugin performs phy diagnostic.

Load Plugins from:

```
/tmp/ibutils2/share/ibdiagnet2.1.1/plugins/
```

You can specify additional paths to be looked in with "IBDIAGNET_PLUGINS_PATH" env variableLoad plugins from:

Plugin Name	Result	Comment
libibdiagnet_cable_diag_plugin-2.1.1	Succeeded	Plugin loaded
libibdiagnet_phy_diag_plugin-2.1.1	Succeeded	Plugin loaded

Syntax

```

[-i|--device <dev-name>] [-p|--port <port-num>]
[-g|--guid <GUID in hex>] [--skip <stage>]
[--skip_plugin <library name>] [--sc]
[--scr] [--pc] [-P|--counter <<PM>=<value>>]
[--pm_pause_time <seconds>] [--ber_test]
[--ber_thresh <value>] [--llr_active_cell <64|128>]

```

```
[--extended_speeds <dev-type>] [--pm_per_lane]
[--ls <2.5|5|10|14|25|FDR10|EDR20>]
[--lw <1x|4x|8x|12x>] [--screen_num_errs <num>]
[--smp_window <num>] [--gmp_window <num>]
[--max_hops <max-hops>] [--read_capability <file name>]
[--write_capability <file name>]
[--back_compat_db <version.sub_version>]
[-V|--version] [-h|--help] [-H|--deep_help]
[--virtual] [--mads_timeout <mads-timeout>]
[--mads_retries <mads-retries>] [-m|--map <map-file>]
[--src_lid <src-lid>] [--dest_lid <dest-lid>]
[--dr_path <dr-path>] [-o|--output_path <directory>]

Cable Diagnostic (Plugin)
[--get_cable_info] [--cable_info_disconnected]
Phy Diagnostic (Plugin)
[--get_phy_info] [--reset_phy_info]
```

Options

<pre> -i --device <dev-name> -p --port <port-num> -g --guid <GUID in hex> --skip <stage> --skip_plugin <library name> --sc --scr --pc -P --counter <<PM>=<value>> --pm_pause_time <seconds> --ber_test --ber_thresh <value> --llr_active_cell <64 128> --extended_speeds <dev-type> --pm_per_lane :List all counters per lane (when available). --ls <2.5 5 10 14 25 FDR10 EDR20> --lw <1x 4x 8x 12x> --screen_num_errs <num> --smp_window <num> --gmp_window <num> --max_hops <max-hops> --read_capability <file name> --write_capability <file name> --back_compat_db <version.sub_version> -V --version -h --help -H --deep_help --virtual --mads_timeout <mads-timeout> --mads_retries <mads-retries> -m --map <map-file> --src_lid <src-lid> --dest_lid <dest-lid> --dr_path <dr-path> -o --output_path <directory> Cable Diagnostic (Plugin) --get_cable_info --cable_info_disconnected Phy Diagnostic (Plugin) --get_phy_info --reset_phy_info </pre>	<pre> :Specifies the name of the device of the port used to connect to the IB fabric (in case of multiple devices on the local system). :Specifies the local device's port number used to connect to the IB fabric. :Specifies the local port GUID value of the port used to connect to the IB fabric. If GUID given is 0 than ibdiagnet displays a list of possible port GUIDs and waits for user input. :Skip the executions of the given stage. Applicable skip stages: (vs_cap_smp vs_cap_gmp links pm speed_width_check all). :Skip the load of the given library name. Applicable skip plugins: (libibdiagnet_cable_diag_plugin-2.1.1 libibdiagnet_phy_diag_plugin-2.1.1). :Provides a report of Mellanox counters :Reset all the Mellanox counters (if -sc option selected). :Reset all the fabric PM counters. :If any of the provided PM is greater than its provided value than print it. :Specifies the seconds to wait between first counters sample and second counters sample. If seconds given is 0 than no second counters sample will be done. (default=1). :Provides a BER test for each port. Calculate BER for each port and check no BER value has exceeds the BER threshold. (default threshold="10^-12"). :Specifies the threshold value for the BER test. The reciprocal number of the BER should be provided. Example: for 10^-12 than value need to be 1000000000000 or 0xe8d4a51000(10^12).If threshold given is 0 than all BER values for all ports will be reported. :Specifies the LLR active cell size for BER test, when LLR is active in the fabric. :Collect and test port extended speeds counters. dev-type: (sw all). :Specifies the expected link speed. :Specifies the expected link width. :Specifies the threshold for printing errors to screen. (default=5). :Max smp MADs on wire. (default=8). :Max gmp MADs on wire. (default=128). :Specifies the maximum hops for the discovery process. (default=64). :Specifies capability masks configuration file, giving capability mask configuration for the fabric. ibdiagnet will use this mapping for Vendor Specific MADs sending. :Write out an example file for capability masks configuration, and also the default capability masks for some devices. :Show ports section in "ibdiagnet2.db_csv" according to given version. Default version 2.0. :Prints the version of the tool. :Prints help information (without plugins help if exists). :Prints deep help information (including plugins help). :Discover VPorts during discovery stage. :Specifies the timeout (in milliseconds) for sent and received mads.(default=500). :Specifies the number of retries for every timeout mad. (default=2). :Specifies mapping file, that maps node guid to name (format: 0x[0-9a-fA-F]+ "name"). Mapping file can also be specified by environment variable "IBUTILS_NODE_NAME_MAP_FILE_PATH". :source lid destination lid :direct route path :Specifies the directory where the output files will be placed. (default="/var/tmp/ibdiagpath/"). :Indicates to query all QSFP cables for cable information. Cable information will be stored in "ibdiagnet2.cables". :Get cable info on disconnected ports. :Indicates to query all ports for phy information. :Indicates to clear all ports phy information. </pre>
--------------------------------------------------------------------------------------------------------------------------------------------------------------------------------------------------------------------------------------------------------------------------------------------------------------------------------------------------------------------------------------------------------------------------------------------------------------------------------------------------------------------------------------------------------------------------------------------------------------------------------------------------------------------------------------------------------------------------------------------------------------------------------------------------------------------------------------------------------------------------------------------------------------------------------------------------------------------------------------------------------------------------------------------------------------------------------------------------------------------------------------	--------------------------------------------------------------------------------------------------------------------------------------------------------------------------------------------------------------------------------------------------------------------------------------------------------------------------------------------------------------------------------------------------------------------------------------------------------------------------------------------------------------------------------------------------------------------------------------------------------------------------------------------------------------------------------------------------------------------------------------------------------------------------------------------------------------------------------------------------------------------------------------------------------------------------------------------------------------------------------------------------------------------------------------------------------------------------------------------------------------------------------------------------------------------------------------------------------------------------------------------------------------------------------------------------------------------------------------------------------------------------------------------------------------------------------------------------------------------------------------------------------------------------------------------------------------------------------------------------------------------------------------------------------------------------------------------------------------------------------------------------------------------------------------------------------------------------------------------------------------------------------------------------------------------------------------------------------------------------------------------------------------------------------------------------------------------------------------------------------------------------------------------------------------------------------------------------------------------------------------------------------------------------------------------------------------------------------------------------------------------------------------------------------------------------------------------------------------------------------------------------------------------------------------------------------------------------------------------------------------------------------------------------------------------------------------------------------------------------------------------------------------------------------------------------------------------------------------------------------------------------------------------------------------------------------------------------------------------------------------------------------------------------------------------------------------------------------------------------------------------------------------------------------------------------------------------------------------------------------------------------------------------------------------------------------------------------------

13.3 Appendix - Supported Port Counters and Events

Port counters and events are available in the following views:

- Events and Port Counters area, at the bottom of the UFM window
- Error window (Error tab) in the Manage Devices tab
- In the New Monitoring Session window, in the Monitor tab, when clicking Create New Session
- Event Log in the Log tab (click Show Event Log)

13.3.1 InfiniBand Port Counters

The following tables list and describe the port counters and events currently supported:

- InfiniBand Port Counters
- Calculated Port Counters

<i>InfiniBand Port Counters</i>	
Counter	Description
Xmit Data (in bytes)	Total number of data octets, divided by 4, transmitted on all VLs from the port, including all octets between (and not including) the start of packet delimiter and the VCRC, and may include packets containing errors. All link packets are excluded. Results are reported as a multiple of four octets.
Rcv Data (in bytes)	Total number of data octets, divided by 4, received on all VLs at the port. All octets between (and not including) the start of packet delimiter and the VCRC are excluded and may include packets containing errors. All link packets are excluded. When the received packet length exceeds the maximum allowed packet length specified in C7-45: the counter may include all data octets exceeding this limit. Results are reported as a multiple of four octets.
Xmit Packets	Total number of packets transmitted on all VLs from the port, including packets with errors and excluding link packets.
Rcv Packets	Total number of packets, including packets containing errors and excluding link packets, received from all VLs on the port.
Rcv Errors	Total number of packets containing errors that were received on the port including: <ul style="list-style-type: none"> • Local physical errors (ICRC, VCRC, LPCRC, and all physical errors that cause entry into the BAD PACKET or BAD PACKET DISCARD states of the packet receiver state machine) • Malformed data packet errors (LVer, length, VL) • Malformed link packet errors (operand, length, VL) • Packets discarded due to buffer overrun (overflow)
Xmit Discards	Total number of outbound packets discarded by the port when the port is down or congested for the following reasons: <ul style="list-style-type: none"> • Output port is not in the active state • Packet length has exceeded NeighborMTU • Switch Lifetime Limit exceeded • Switch HOQ Lifetime Limit exceeded, including packets discarded while in VLStalled State.

<i>InfiniBand Port Counters</i>	
Counter	Description
Symbol Errors	Total number of minor link errors detected on one or more physical lanes.
Link Error Recovery	Total number of times the Port Training state machine has successfully completed the link error recovery process.
Link Error Downed	Total number of times the Port Training state machine has failed the link error recovery process and downed the link.
Local Integrity Error	The number of times that the count of local physical errors exceeded the threshold specified by LocalPhyErrors
Rcv Remote Physical Error	Total number of packets marked with the EBP delimiter received on the port.
Xmit Constraint Error	Total number of packets not transmitted from the switch physical port for the following reasons: <ul style="list-style-type: none"> • FilterRawOutbound is true and packet is raw • PartitionEnforcementOutbound is true and packet fails partition key check or IP version check
Rcv Constraint Error	Total number of packets received on the switch physical port that are discarded for the following reasons: <ul style="list-style-type: none"> • FilterRawInbound is true and packet is raw • PartitionEnforcementInbound is true and packet fails partition key check or IP version check
Excess Buffer Overrun Error	The number of times that OverrunErrors consecutive flow control update periods occurred, each having at least one overrun error
Rcv Switch Relay Error	Total number of packets received on the port that were discarded when they could not be forwarded by the switch relay for the following reasons: <ul style="list-style-type: none"> • DLID mapping • VL mapping • Looping (output port = input port)
VL15 Dropped	Number of incoming VL15 packets dropped because of resource limitations (e.g., lack of buffers) in the port
XmitWait	The number of ticks during which the port selected by PortSelect had data to transmit but no data was sent during the entire tick because of insufficient credits or of lack of arbitration.

<i>InfiniBand Calculated Port Counters</i>	
Counter	Description
Normalized XmitData	Effective port bandwidth utilization in % XmitData incremental/ Link Capacity
Normalized Congested Bandwidth	Amount of bandwidth that was suppressed due to congestion (XmitWait incremental/ Time) * Link Capacity Separate counters are used for Tier 4 ports and for the rest of the ports.

13.3.2 Supported Traps and Events

Device events are listed as VDM or CDM in the Source column of the Events table in the UFM GUI. For information about defining event policy, see [Configuring Event Management](#).

Alarm ID	Alarm Name	To Log	Alarm	Default Severity	Default Threshold	Default TTL	Related Object	Category	Source
64	GID Address In Service	1	0	Info	1	0	Port	Fabric Notification	SM
65	GID Address Out of Service	1	0	Warning	1	0	Port	Fabric Notification	SM
66	New MCast Group Created	1	0	Info	1	0	Port	Fabric Notification	SM
67	MCast Group Deleted	1	0	Info	1	0	Port	Fabric Notification	SM
110	Symbol Error	1	1	Warning	200	0	Port	Hardware	Telemetry
111	Link Error Recovery	1	1	Minor	1	0	Port	Hardware	Telemetry
112	Link Downed	1	1	Critical	0	0	Port	Hardware	Telemetry
113	Port Receive Errors	1	1	Minor	5	0	Port	Hardware	Telemetry
114	Port Receive Remote Physical Errors	0	0	Minor	5	0	Port	Hardware	Telemetry
115	Port Receive Switch Relay Errors	1	1	Minor	50	0	Port	Fabric Configuration	Telemetry
116	Port Xmit Discards	1	1	Minor	200	0	Port	Communication Error	Telemetry
117	Port Xmit Constraint Errors	1	1	Minor	1	0	Port	Communication Error	Telemetry
118	Port Receive Constraint Errors	1	1	Minor	1	0	Port	Communication Error	Telemetry
119	Local Link Integrity Errors	1	1	Minor	5	0	Port	Hardware	Telemetry
120	Excessive Buffer Overrun Errors	1	1	Minor	1	0	Port	Communication Error	Telemetry
121	VL15 Dropped	1	1	Minor	500	0	Port	Communication Error	Telemetry

Alarm ID	Alarm Name	To Log	Alarm	Default Severity	Default Threshold	Default TTL	Related Object	Category	Source
122	Congested Bandwidth (%) Threshold Reached	1	1	Minor	10	0	Port	Hardware	Telemetry
123	Port Bandwidth (%) Threshold Reached	1	1	Minor	95	0	Port	Communication Error	Telemetry
130	Non-optimal link width	1	1	Minor	1	0	Port	Hardware	SM
134	T4 Port Congested Bandwidth	1	1	Warning	10	0	Port	Communication Error	Telemetry
141	Flow Control Update Watchdog Timer Expired	1	0	Warning	1	0	Port	Hardware	SM
144	Capability Mask Modified	1	0	Info	1	0	Port	Fabric Notification	SM
145	System Image GUID changed	1	0	Info	1	0	Port	Communication Error	SM
156	Link Speed Enforcement Disabled	1	0	Critical	0	0	Site	Fabric Notification	SM
250	Running in Limited Mode	1	1	Critical	1	0	Grid	Maintenance	Licensing
251	Switching to Limited Mode	1	1	Critical	1	0	Grid	Maintenance	Licensing
252	License Expired	1	1	Warning	1	0	Grid	Maintenance	Licensing
253	Duplicated licenses	1	0	Critical	1	0	Grid	Maintenance	Licensing
254	License Limit Exceeded	1	0	Critical	1	0	Grid	Maintenance	Licensing
255	License is About to Expire	1	0	Warning	1	0	Grid	Maintenance	Licensing
256	Bad M_Key	1	0	Minor	1	0	Port	Security	SM
257	Bad P_Key	1	0	Minor	1	0	Port	Security	SM
258	Bad Q_Key	1	0	Minor	1	0	Port	Security	SM
259	Bad P_Key Switch External Port	1	0	Critical	1	0	Port	Security	SM
328	Link is Up	1	1	Info	1	10	Link	Fabric Topology	SM
329	Link is Down	1	1	Warning	1	10	Site	Fabric Topology	SM
331	Node is Down	1	0	Warning	1	0	Site	Fabric Topology	SM

Alarm ID	Alarm Name	To Log	Alarm	Default Severity	Default Threshold	Default TTL	Related Object	Category	Source
332	Node is Up	1	0	Info	1	0	Site	Fabric Topology	SM
336	Port Action Succeeded	1	0	Info	1	0	Port	Maintenance	UFM
337	Port Action Failed	1	0	Minor	1	0	Port	Maintenance	UFM
338	Device Action Succeeded	1	0	Info	1	0	Port	Maintenance	UFM
339	Device Action Failed	1	0	Minor	1	0	Port	Maintenance	UFM
344	Partial Switch ASIC Failure	1	1	Critical	1	0	Switch	Maintenance	UFM
352	Network Added	1	0	Info	1	0	Network	Logical Model	UFM
353	Network Removed	1	0	Info	1	0	Network	Logical Model	UFM
380	Switch Upgrade Error	1	1	Critical	1	0	Switch	Maintenance	UFM
381	Switch Upgrade Failed	1	0	Info	1	0	Switch	Maintenance	UFM
382	Module status NOT PRESENT	1	1	Warning	1	0	Switch	Module Status	UFM
383	Host Upgrade Failed	1	0	Info	1	0	Computer	Maintenance	UFM
384	Switch Module Powered Off	1	1	Info	1	0	Switch	Module Status	UFM
385	Switch FW Upgrade Started	1	0	Info	1	0	Switch	Maintenance	UFM
386	Switch SW Upgrade Started	1	0	Info	1	0	Switch	Maintenance	UFM
387	Switch Upgrade Finished	1	0	Info	1	0	Switch	Maintenance	UFM
388	Host FW Upgrade Started	1	0	Info	1	0	Computer	Maintenance	UFM
389	Host OFED Upgrade Started	1	0	Info	1	0	Computer	Maintenance	UFM
391	Switch Module Removed	1	0	Info	1	0	Switch	Fabric Notification	Switch
392	Module Temperature Threshold Reached	1	0	Info	60	0	Module	Hardware	Switch

Alarm ID	Alarm Name	To Log	Alarm	Default Severity	Default Threshold	Default TTL	Related Object	Category	Source
393	Switch Module Added	1	0	Info	1	0	Switch	Fabric Notification	Switch
394	Module Status FAULT	1	1	Critical	1	0	Switch	Module Status	Switch
395	Device Action Started	1	0	Info	1	0	Port	Maintenance	UFM
396	Site Action Started	1	0	Info	1	0	Port	Maintenance	UFM
397	Site Action Failed	1	0	Minor	1	0	Port	Maintenance	UFM
398	Switch Chip Added	1	0	Info	1	0	Switch	Fabric Notification	Switch
399	Switch Chip Removed	1	0	Critical	1	0	Switch	Fabric Notification	Switch
403	Device Pending Reboot	1	1	Warning	0	0	Device	Maintenance	UFM
404	System Information is missing	1	1	Warning	1	0	Switch	Communication Error	UFM
405	Switch Identity Validation Failed	1	1	Warning	1	0	Switch	Communication Error	UFM
406	Switch System Information is missing	1	1	Warning	1	0	Switch	Communication Error	UFM
407	COMEX Ambient Temperature Threshold Reached	1	1	Minor	60	0	Switch	Hardware	Switch
408	Switch is Unresponsive	1	1	Critical	1	0	Switch	Communication Error	UFM
502	Device Upgrade Finished	1	0	Info	1	0	Device	Maintenance	UFM
506	Device Upgrade Finished	1	0	Info	1	0	Device	Maintenance	UFM
508	Core Dump Created	1	1	Info	1	0	Grid	Maintenance	UFM
510	SM Failover	0	1	Critical	1	0	Grid	Fabric Notification	SM

Alarm ID	Alarm Name	To Log	Alarm	Default Severity	Default Threshold	Default TTL	Related Object	Category	Source
511	SM State Change	0	1	Info	1	0	Grid	Fabric Notification	SM
512	SM UP	0	1	Info	1	0	Grid	Fabric Notification	SM
513	SM System Log Message	0	1	Minor	1	0	Grid	Fabric Notification	SM
514	SM LID Change	0	1	Warning	1	0	Grid	Fabric Notification	SM
515	Fabric Health Report Info	1	1	Info	1	0	Grid	Fabric Notification	UFM
516	Fabric Health Report Warning	1	1	Warning	1	0	Grid	Fabric Notification	UFM
517	Fabric Health Report Error	1	1	Critical	1	0	Grid	Fabric Notification	UFM
518	UFM-related process is down	1	1	Critical	1	0	Grid	Maintenance	UFM
519	Logs purge failure	1	1	Minor	1	0	Grid	Maintenance	UFM
520	Restart of UFM-related process succeeded	1	1	Info	1	0	Grid	Maintenance	UFM
521	UFM is being stopped	1	1	Critical	1	0	Grid	Maintenance	UFM
522	UFM is being restarted	1	1	Critical	1	0	Grid	Maintenance	UFM
523	UFM failover is being attempted	1	1	Info	1	0	Grid	Maintenance	UFM
524	UFM cannot connect to DB	1	1	Critical	1	0	Grid	Maintenance	UFM
525	Disk utilization threshold reached	1	1	Critical	1	0	Grid	Maintenance	UFM
526	Memory utilization threshold reached	1	1	Critical	1	0	Grid	Maintenance	UFM
527	CPU utilization threshold reached	1	1	Critical	1	0	Grid	Maintenance	UFM
528	Fabric interface is down	1	1	Critical	1	0	Grid	Maintenance	UFM
529	UFM standby server problem	1	1	Critical	1	0	Grid	Maintenance	UFM

Alarm ID	Alarm Name	To Log	Alarm	Default Severity	Default Threshold	Default TTL	Related Object	Category	Source
530	SM is down	1	1	Critical	1	0	Grid	Maintenance	UFM
531	DRBD Bad Condition	1	1	Critical	1	0	Grid	Maintenance	UFM
532	Remote UFM-SM Sync	1	1	Info	1	0	Grid	Maintenance	UFM
533	Remote UFM-SM problem	1	1	Critical	1	0	Site	Maintenance	UFM
536	UFM Health Watchdog Info	1	1	Info	1	0	Grid	Maintenance	UFM
537	UFM Health Watchdog Critical	1	1	Critical	1	0	Grid	Maintenance	UFM
538	Time Diff Between HA Servers	1	1	Warning	1	0	Grid	Maintenance	UFM
539	DRBD TCP Connection Performance	1	1	Warning	1	0	Grid	Maintenance	UFM
540	Daily Report Completed successfully	1	0	Info	1	0	Grid	Maintenance	UFM
541	Daily Report Completed with Error	1	0	Minor	1	0	Grid	Maintenance	UFM
542	Daily Report Failed	1	0	Critical	1	0	Grid	Maintenance	UFM
543	Daily Report Mail Sent successfully	1	0	Info	1	0	Grid	Maintenance	UFM
544	Daily Report Mail Sent Failed	1	0	Minor	1	0	Grid	Maintenance	UFM
545	SM is not responding	1	1	Critical	1	0	Grid	Maintenance	UFM
546	Management interface is down	1	1	Critical	1	0	Grid	Maintenance	UFM
547	UFM stopped polling SM for updates	1	1	Critical	1	0	Grid	Maintenance	UFM
548	Failed to run generic script test	1	1	Critical	1	0	Grid	Maintenance	UFM
551	General External Event Notification	1	0	Info	0	0	Grid	Maintenance	UFM
552	General External Event Notice	1	0	Minor	0	0	Grid	Maintenance	UFM
553	General External Event Alert	1	0	Warning	0	0	Grid	Maintenance	UFM
554	General External Event Error	1	0	Critical	0	0	Grid	Maintenance	UFM
560	User Connected	1	0	Info	1	0	Grid	Security	UFM

Alarm ID	Alarm Name	To Log	Alarm	Default Severity	Default Threshold	Default TTL	Related Object	Category	Source
561	User Disconnected	1	0	Info	1	0	Grid	Security	UFM
602	UFM Server Failover	1	1	Critical	1	0	Site	Fabric Notification	UFM
603	Events Suppression	1	0	Critical	0	0	Site	Maintenance	UFM
604	Report Succeeded	1	1	Info	1	0	Grid	Maintenance	UFM
605	Report Failed	1	1	Critical	1	0	Grid	Maintenance	UFM
606	Correction Attempts Paused	1	0	Warning	1	0	Site	Fabric Notification	UFM
610	Monitoring History Enabled	1	0	Info	1	0	Grid	Maintenance	UFM
611	Monitoring History Disabled	1	0	Info	1	0	Grid	Maintenance	UFM
612	Monitoring History Bad Connection	1	1	Critical	1	0	Grid	Maintenance	UFM
613	Monitoring History Connection Established	1	0	Info	1	0	Grid	Maintenance	UFM
614	Monitoring History Inconsistent Version	1	1	Critical	1	0	Grid	Maintenance	UFM
615	Monitoring History Failed save metadata	1	1	Critical	1	0	Grid	Maintenance	UFM
616	Monitoring History Failed update metadata	1	1	Critical	1	0	Grid	Maintenance	UFM
617	Monitoring History Failed save data	1	1	Critical	1	0	Grid	Maintenance	UFM
618	Monitoring History Failed get metadata	1	1	Critical	1	0	Grid	Maintenance	UFM
619	Monitoring History Failed get data	1	1	Critical	1	0	Grid	Maintenance	UFM
620	Monitoring History Failed remove file	1	1	Critical	1	0	Grid	Maintenance	UFM
621	Monitoring History version not matches UFM version	1	1	Critical	1	0	Grid	Maintenance	UFM
622	Monitoring History Purge DB Occurred	1	1	Warning	1	0	Grid	Maintenance	UFM
623	Monitoring History Migration is not completed	1	1	Warning	1	0	Grid	Maintenance	UFM

Alarm ID	Alarm Name	To Log	Alarm	Default Severity	Default Threshold	Default TTL	Related Object	Category	Source
624	Monitoring History partition utilization threshold reached	1	1	Critical	1	0	Grid	Maintenance	UFM
625	Monitoring History local report files are about to be cleaned	1	0	Info	1	0	Grid	Maintenance	UFM
626	Monitoring History oldest DB table is about to be removed	1	0	Info	1	0	Grid	Maintenance	UFM
627	Monitoring History partition is not mounted	1	0	Critical	1	0	Grid	Maintenance	UFM
701	Non-optimal Link Speed	1	1	Minor	1	0	Port	Hardware	UFM
702	Unhealthy IB Port	1	1	Warning	1	0	Port	Hardware	SM
703	Fabric Collector Connected	1	0	Info	1	0	Grid	Maintenance	UFM
704	Fabric Collector Disconnected	1	1	Critical	1	0	Grid	Maintenance	UFM
750	High data retransmission count on port	1	1	Warning	500	0	Port	Hardware	SM
901	Fabric Configuration Started	0	1	Info	1	0	Grid	Fabric Notification	UFM
902	Fabric Configuration Completed	0	1	Info	1	0	Grid	Fabric Notification	UFM
903	Fabric Configuration Failed	0	1	Critical	1	0	Grid	Fabric Notification	UFM
904	Device Configuration Failure	0	1	Critical	1	0	Device	Fabric Notification	UFM
905	Device Configuration Timeout	0	1	Critical	1	0	Device	Fabric Notification	UFM
906	Provisioning Validation Failure	0	1	Critical	1	0	Grid	Fabric Notification	UFM
907	Switch is Down	1	1	Critical	1	0	Site	Fabric Topology	UFM
908	Switch is Up	1	1	Info	1	0	Site	Fabric Topology	UFM
909	Director Switch is Down	1	1	Critical	1	0	Site	Fabric Topology	UFM
910	Director Switch is Up	1	1	Info	1	0	Site	Fabric Topology	UFM

Alarm ID	Alarm Name	To Log	Alarm	Default Severity	Default Threshold	Default TTL	Related Object	Category	Source
911	Module Temperature Low Threshold Reached (Unmanaged IB switches only)	1	1	Warning	0	0	Module	Hardware	Telemetry
912	Module Temperature High Threshold Reached (Unmanaged IB switches only)	1	1	Critical	60	0	Module	Hardware	Telemetry
913	Module High Voltage	1	1	Warning	15	0	Switch	Module Status	Telemetry
914	Module High Current	1	1	Warning	10	0	Switch	Module Status	Telemetry
915	Critical BER reported	1	1	Critical	10	0	Port	Hardware	Telemetry
916	High BER reported	1	1	Warning	10	0	Port	Hardware	Telemetry
917	Critical Symbol BER reported	1	1	Critical	10	0	Port	Hardware	Telemetry
918	High Symbol BER reported	1	1	Warning	10	0	Port	Hardware	Telemetry
919	Cable Temperature High	1	1	Critical	1	0	Port	Hardware	UFM
920	Cable Temperature Low	1	1	Critical	1	0	Port	Hardware	UFM
1300	SA Key violation	1	1	Warning	5	0	Port	Security	SM
1301	SGID Spoofed	1	1	Warning	5	0	Port	Security	SM
1302	SA High Rate detected	1	1	Warning	5	0	Port	Security	SM
1303	Multicast subscriptions over limit	1	1	Warning	5	0	Port	Security	SM
1304	Service Record subscriptions over limit	1	1	Warning	5	0	Port	Security	SM
1305	Event subscriptions over limit	1	1	Warning	5	0	Port	Security	SM
1306	Unallowed SM was detected in the fabric	1	1	Warning	0	0	Port	Fabric Notification	SM
1307	SMInfo SET request was received from unallowed SM	1	1	Warning	0	0	Port	Fabric Notification	SM
1309	SM was detected with non-matching SMKey	1	1	Warning	0	0	Port	Fabric Notification	SM
1310	Duplicated node GUID was detected	1	1	Critical	1	0	Device	Fabric Notification	SM

Alarm ID	Alarm Name	To Log	Alarm	Default Severity	Default Threshold	Default TTL	Related Object	Category	Source
1311	Duplicated port GUID was detected	1	1	Critical	1	0	Port	Fabric Notification	SM
1312	Switch was Rebooted	1	1	Info	1	0	Device	Fabric Notification	UFM
1315	Topo Config File Error	1	1	Critical	1	0	Grid	Fabric Notification	UFM
1316	Topo Config Subnet Mismatch	1	1	Critical	1	0	Grid	Fabric Notification	Topodiff
1400	High Ambient Temperature	1	1	Warning	0	0	Switch	Hardware	Switch
1401	High Fluid Temperature	1	1	Warning	0	0	Switch	Hardware	Switch
1402	Low Fluid Level	1	1	Warning	0	0	Switch	Hardware	Switch
1403	Low Supply Pressure	1	1	Warning	0	0	Switch	Hardware	Switch
1404	High Supply Pressure	1	1	Warning	0	0	Switch	Hardware	Switch
1405	Low Return Pressure	1	1	Warning	0	0	Switch	Hardware	Switch
1406	High Return Pressure	1	1	Warning	0	0	Switch	Hardware	Switch
1407	High Differential Pressure	1	1	Warning	0	0	Switch	Hardware	Switch
1408	Low Differential Pressure	1	1	Warning	0	0	Switch	Hardware	Switch
1409	System Fail Safe	1	1	Warning	0	0	Switch	Hardware	Switch
1410	Fault Critical	1	1	Critical	0	0	Switch	Hardware	Switch
1411	Fault Pump1	1	1	Critical	0	0	Switch	Hardware	Switch
1412	Fault Pump2	1	1	Critical	0	0	Switch	Hardware	Switch
1413	Fault Fluid Level Critical	1	1	Critical	0	0	Switch	Hardware	Switch
1414	Fault Fluid Over Temperature	1	1	Critical	0	0	Switch	Hardware	Switch
1415	Fault Primary DC	1	1	Critical	0	0	Switch	Hardware	Switch
1416	Fault Redundant DC	1	1	Critical	0	0	Switch	Hardware	Switch
1417	Fault Fluid Leak	1	1	Critical	0	0	Switch	Hardware	Switch
1418	Fault Sensor Failure	1	1	Critical	0	0	Switch	Hardware	Switch
1419	Cooling Device Monitoring Error	1	0	Critical	0	0	Grid	Hardware	Switch
1420	Cooling Device Communication Error	1	1	Critical	0	0	Switch	Hardware	Switch
1500	New cable detected	1	0	Info	1	0	Link	Security	UFM

Alarm ID	Alarm Name	To Log	Alarm	Default Severity	Default Threshold	Default TTL	Related Object	Category	Source
1502	Cable detected in a new location	1	0	Warning	1	0	Link	Security	UFM
1503	Duplicate Cable Detected	1	0	Critical	1	0	Link	Security	UFM
1504	SHARP Allocation Succeeded	1	1	Info	1	0	Grid	SHARP	SHARP
1505	SHARP Allocation Failed	1	0	Warning	1	0	Grid	SHARP	SHARP
1506	SHARP Deallocation Succeeded	1	0	Info	1	0	Grid	SHARP	SHARP
1507	SHARP Deallocation Failed	1	0	Warning	1	0	Grid	SHARP	SHARP
1508	Device Collect System Dump Started	1	0	Info	1	0	Device	Maintenance	UFM
1509	Device Collect System Dump Finished	1	0	Info	1	0	Device	Maintenance	UFM
1510	Device Collect System Dump Error	1	0	Critical	1	0	Device	Maintenance	UFM
1511	Virtual Port Added	1	0	Info	1	0	Port	Fabric Notification	SM
1512	Virtual Port Removed	1	0	Warning	1	0	Port	Fabric Notification	SM
1513	Burn Cables Transceivers Started	1	0	Info	1	0	Device	Maintenance	UFM
1514	Burn Cables Transceivers Finished	1	0	Info	1	0	Device	Maintenance	UFM
1515	Burn Cables Transceivers Failed	1	0	Warning	1	0	Device	Maintenance	UFM
1516	Activate Cables Transceivers FW Finished	1	0	Info	1	0	Device	Maintenance	UFM
1517	Activate Cables Transceivers FW Failed	1	0	Warning	1	0	Device	Maintenance	UFM
1520	Aggregation Node Discovery Failed	1	0	Critical	1	0	SHARP AM	SHARP	SHARP
1521	Job Started	1	0	Info	1	0	SHARP AM	SHARP	SHARP
1522	Job Ended	1	0	Info	1	0	SHARP AM	SHARP	SHARP
1523	Job Start Failed	1	0	Critical	1	0	SHARP AM	SHARP	SHARP

Alarm ID	Alarm Name	To Log	Alarm	Default Severity	Default Threshold	Default TTL	Related Object	Category	Source
1524	Job Error	1	0	Critical	1	0	SHARP AM	SHARP	SHARP
1525	Trap QP Error	1	0	Critical	1	0	SHARP AM	SHARP	SHARP
1526	Trap Invalid Request	1	0	Critical	1	0	SHARP AM	SHARP	SHARP
1527	Trap Sharp Error	1	0	Critical	1	0	SHARP AM	SHARP	SHARP
1528	Trap QP Alloc timeout	1	0	Critical	1	0	SHARP AM	SHARP	SHARP
1529	Trap AMKey Violation	1	0	Critical	1	0	SHARP AM	SHARP	SHARP
1530	Unsupported Trap	1	0	Critical	1	0	SHARP AM	SHARP	SHARP
1531	Reservation Updated	1	0	Info	1	0	SHARP AM	SHARP	SHARP
1532	Sharp is not Responding	1	0	Critical	1	0	SHARP AM	SHARP	SHARP
1533	Agg Node Active	1	0	Info	1	0	SHARP AM	SHARP	SHARP
1534	Agg Node Inactive	1	0	Warning	1	0	SHARP AM	SHARP	SHARP
1535	Trap AMKey Violation Triggered by AM	1	0	Warning	1	0	SHARP AM	SHARP	SHARP
1550	GUIDs Were Added to Pkey	1	0	Info	1	0	Port	Fabric Notification	UFM
1551	GUIDs Were Removed from Pkey	1	0	Info	1	0	Port	Fabric Notification	UFM
1600	VS/CC Classes Key Violation	1	0	Warning	1	0	Port	Security	SM
1601	Tenant Access Violation	1	0	Warning	1	0	Port	Security	SM
1602	PCI Speed Degradation Warning	1	1	Critical	1	0	Port	Fabric Notification	UFM
1603	PCI Width Degradation Warning	1	1	Critical	1	0	Port	Fabric Notification	UFM
1604	Non-optimal aggregated port bandwidth	1	1	Warning	1	0	Port	Hardware	UFM
1605	Routing Engine Action Remove	1	1	Warning	1	0	Switch	Fabric Notification	UFM

Alarm ID	Alarm Name	To Log	Alarm	Default Severity	Default Threshold	Default TTL	Related Object	Category	Source
1606	Routing Engine Action Recover	1	1	Info	1	0	Switch	Fabric Notification	UFM

13.4 Appendix - Used Ports

The following is the list of ports used by the UFM Server for internal and external communication:

Port	Purpose
80(tcp), 443(tcp)	Used by WS clients (Apache Web Server)
8000(udp)	Used for UFM server listening for REST API requests (redirected by Apache web server)
6306(udp)	Used for Multicast requests - communication with latest UFM Agents
8005(udp)	Used as UFM monitoring listening port
8089(tcp)	Used for internal communication between UFM server and MonitoringHistoryEngine
8888(tcp)	Used by DRBD - communication between UFM Primary and Standby server
15800(tcp)	Used for communication with legacy UFM Agents on Mellanox Grid Director DDR switches
8081(tcp), 8082(tcp)	Used for internal communication with Subnet Manager

13.5 Appendix - Configuration Files Auditing

The main purpose of this feature is to allow users to track changes made to selected configuration files. When activating the feature, all the changes are reflected in specific log files which contain information about the changes and when they took place.

To activate this feature:

In *TrackConfig* section in *gv.cfg*, file value of *track_config* key should be set to true and value of *track_conf_files* key should contain a comma-separated list of defined conf files to be tracked. By default - ALL conf-files are tracked. To activate the feature, after *track_config* key is set to true, the UFM server should be restarted.

Example:

```
[TrackConfig]
# track config files changes
track_config = true
# Could be selected options (comaseparated) UFM, SM, SHARP, Telemetry. Or ALL for all the files.
track_conf_files = ALL
```

The below lists the configuration files that can be tracked:

Conf File Alias	Configuration Files
UFM	/opt/ufm/files/conf/gv.cfg
SM	/opt/ufm/files/conf/opensm/opensm.conf
SHARP	/opt/ufm/files/conf/sharp2/sharp_am.cfg
Telemetry	/opt/ufm/files/conf/telemetry/launch_ibdiagnet_config.ini
ALL	All the above configuration files.

Once the feature is activated and the UFM server is restarted, the UFM generates file which list the changes made in each of the tracked conf files. These files are located in `/opt/ufm/files/auditing/` directory and the file naming convention is as follows: original conf file name with audit.log suffix.

Example: For gv.cfg, the name of the changes-tracking file is gv.cfg.audit.log. Changes are stored in auditing files in “linux diff”-like format.

Example:

```

cat /opt/ufm/files/auditing/gv.cfg.audit.log
=== Change occurred at 2022-07-24 07:31:48.679247 ===
---
+++
@@ -45,7 +45,7 @@
mon_mode_discovery_period = 60
check_interface_retry = 5
# The number of times to try if the InfiniBand fabric interface is down. The duration of each retry is 1 second.
-ibport_check_retries = 90
+ibport_check_retries = 92
ws_address = UNDEFINED
ws_port = 8088
ws_protocol = https

```

13.6 Appendix - IB Router

IB router provides the ability to send traffic between two or more IB subnets thereby potentially expanding the size of the network to over 40k end-ports, enabling separation and fault resilience between islands and IB subnets, and enabling connection to different topologies used by different subnets.

The forwarding between the IB subnets is performed using GRH lookup. The IB router’s basic functionality includes:

- Removal of current L2 LRH (local routing header)
- Routing table lookup - using GID from GRH
- Building new LRH according to the destination according to the routing table

The DLID in the new LRH is built using simplified GID-to-LID mapping (where LID = 16 LSB bits of GID) thereby not requiring to send for ARP query/lookup.

Site-Local Unicast GID Format

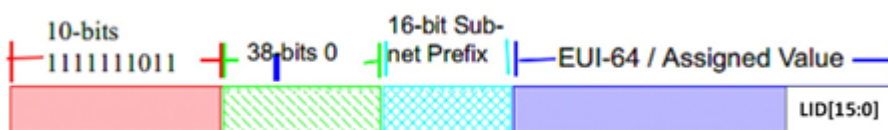

For this to work, the SM allocates an alias GID for each host in the fabric where the alias GID = {subnet prefix[127:64], reserved[63:16], LID[15:0]}. Hosts should use alias GIDs in order to transmit traffic to peers on remote subnets.

Host-to-Host IB Router Unicast Flow

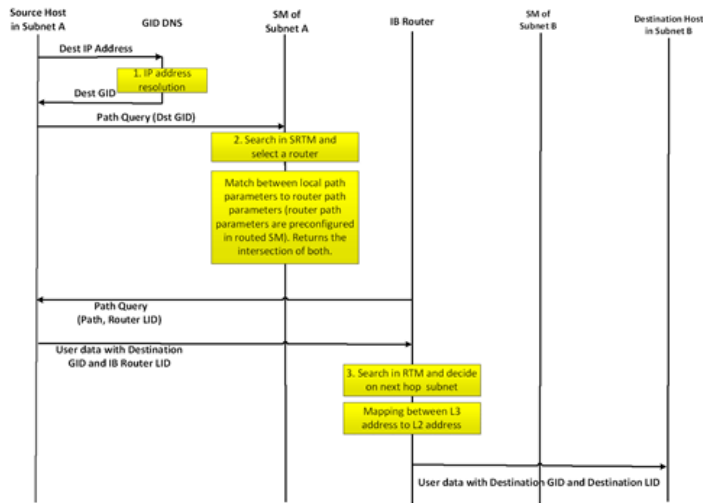

13.6.1 IB Router Scripts

The following scripts are supplied as part of UFM installation package.

13.6.1.1 set_num_of_subnets.sh

- Arguments

```
/opt/ufm/scripts/ib_router/set_num_of_subnets.sh --hostname <hostname> --username <username> --password <password> --num-of-subnets <num-of-subnets>
```

- Description - Configures system profile to InfiniBand allowing multiple switch IDs
- Syntax Description

hostname	IB router hostname or IP address
username	IB router username
password	IB router user password
num-of-subnets	Specified number of subnets (AKA SWIDs) to be initialized by the system. Value range: 2-6

- Example

```
/opt/ufm/scripts/ib_router/set_num_of_subnets.sh --hostname 10.6.204.12 --username admin --password admin --num-of-subnets 6
```

As a result of running this script, reboot is performed and all configuration is removed

13.6.1.2 add_interfaces_to_subnet.sh

- Arguments

```
/opt/ufm/scripts/ib_router/add_interfaces_to_subnet.sh --hostname <hostname> --username <username> --password <password> --interface <interface | interface-range> --subnet <subnet>
```

- Description
Maps an interface to a subnet and enables it

- SyntaxDescription

hostname	IB router hostname or IP address
username	IB router username
password	IB router user password
interface interface-range	Single IB interface or range of IB interfaces. Single IB interface: 1/<interface> Range of IB interfaces: 1/<interface>-1/<interface>
subnet	Name of IB subnet (AKA SWID): infiniband-default, infiniband-1...infiniband-5

- Example

```
/opt/ufm/scripts/ib_router/add_interfaces_to_subnet.sh --hostname 10.6.204.12 --username admin --password admin --interface 1/1-1/6 --subnet infiniband-1
```

13.6.1.3 remove_interfaces_from_subnet.sh

- Arguments

```
/opt/ufm/scripts/ib_router/remove_interfaces_from_subnet.sh --hostname <hostname> --username <username> --password <password> --interface <interface | interface-range>
```

- Description
Un-maps an interface from a subnet after it has been disabled

- Syntax Description

hostname	IB router hostname or IP address
username	IB router username
password	IB router user password
interface interface-range	Single IB interface or range of IB interfaces. Single IB interface: 1/<interface> Range of IB interfaces: 1/<interface>-1/<interface>

- Example

```
/opt/ufm/scripts/ib_router/remove_interfaces_from_subnet.sh --hostname 10.6.204.12 --username admin --password admin --interface 1/6Example
```

13.6.1.4 add_subnet_to_router.sh

- Arguments

```
/opt/ufm/scripts/ib_router/add_subnet_to_router.sh --hostname <hostname> --username <username> --password <password> --subnet <subnet>
```

- Description

Creates routing on IB subnet interface and enables routing on that interface

- Syntax Description

hostname	IB router hostname or IP address
username	IB router username
password	IB router user password
subnet	Name of IB subnet (AKA SWID): infiniband-default, infiniband-1... infiniband-5

- Example

```
/opt/ufm/scripts/ib_router/add_subnet_to_router.sh --hostname 10.6.204.12 --username admin --password admin --subnet infiniband-3Example
```

As a result of running this script, the set of commands that allow control of IB router functionality is being enabled

13.6.1.5 remove_subnet_from_router.sh

- Arguments

```
/opt/ufm/scripts/ib_router/remove_subnet_from_router.sh --hostname <hostname> --username <username> --password <password> --subnet <subnet>
```

- Description

Destroys routing on IB subnet interface after routing on that interface has been disabled

- Syntax Description

hostname	IB router hostname or IP address
username	IB router username
password	IB router user password
subnet	Name of IB subnet (AKA SWID): infiniband-default, infiniband-1... infiniband-5

- Example

```
/opt/ufm/scripts/ib_router/remove_subnet_from_router.sh --hostname 10.6.204.12 --username admin --password admin --subnet infiniband-defaultExample
```

13.6.1.6 set_ufm_sm_router_support.sh

- Arguments

```
/opt/ufm/scripts/ib_router/set_ufm_sm_router_support.sh [-c <subnet prefix>] [-r] [-h]
```

- Description

[-c <subnet prefix>]: Used for updating OpenSM configuration file with new subnet prefix and forces OpenSM to re-read configuration.

[-r]: Used for resetting OpenSM configuration to default value and canceling IB routing.

- Syntax Description

-c	Configure new IB subnet prefix. Should be followed by new IB router subnet prefix value
-r	Reset to default
-h	Show help

- Example

```
/opt/ufm/scripts/ib_router/set_ufm_sm_router_support.sh -c 0xfec000000001234Examples
```

```
/opt/ufm/scripts/ib_router/set_ufm_sm_router_support.sh -r
```

13.6.2 IB Router Configuration

Step 1: Configure multi-switch. Run:

```
/opt/ufm/scripts/set_num_of_subnets.sh --hostname 10.6.204.12 --username admin --password admin --num-of-subnets 6
```

Step 2: Map interface to a subnet. Run:

```
/opt/ufm/scripts/add_ports_to_subnet.sh --hostname 10.6.204.12 --username admin --password admin --interface 1/1 --subnet infiniband-default
```

Step 3: Create routing on IB subnet interface. Run:

```
/opt/ufm/scripts/add_subnet_to_router.sh --hostname 10.6.204.12 --username admin --password admin --subnet infiniband-default
```

13.7 Appendix - NVIDIA SHARP Integration

13.7.1 NVIDIA Scalable Hierarchical Aggregation and Reduction Protocol (SHARP)™

NVIDIA SHARP is a technology that improves the performance of MPI operation by offloading collective operations from the CPU and dispatching to the switch network, and eliminating the need

to send data multiple times between endpoints. This approach decreases the amount of data traversing the network as aggregation nodes are reached, and dramatically reduces the MPI operation time.

NVIDIA SHARP software is based on:

- Hardware capabilities in Switch-IB™ 2
- Hierarchical communication algorithms (HCOL) library into which NVIDIA SHARP capabilities are integrated
- NVIDIA SHARP daemons, running on the compute nodes
- NVIDIA SHARP Aggregation Manager, running on UFM

1. These components should be installed from HPCX or MLNX_OFED packages on compute nodes. Installation details can be found in SHARP Deployment Guide.

13.7.2 NVIDIA SHARP Aggregation Manager

Aggregation Manager (AM) is a system management component used for system level configuration and management of the switch-based reduction capabilities. It is used to set up the NVIDIA SHARP trees, and to manage the use of these entities.

AM is responsible for:

- NVIDIA SHARP resource discovery
- Creating topology aware NVIDIA SHARP trees
- Configuring NVIDIA SHARP switch capabilities
- Managing NVIDIA SHARP resources
- Assigning NVIDIA SHARP resource upon request
- Freeing NVIDIA SHARP resources upon job termination

AM is configured by a topology file created by Subnet Manager (SM): subnet.lst. The file includes information about switches and HCAs.

13.7.2.1 NVIDIA SHARP AM Prerequisites

In order for UFM to run NVIDIA SHARP AM, the following conditions should be met:

- Managed InfiniBand fabric must include at least one of the following Switch-IB 2 switches with minimal firmware version of 15.1300.0126:
 - CS7500
 - CS7510
 - CS7520
 - MSB7790
 - MSB7800
- NVIDIA SHARP software capability should be enabled for all Switch-IB 2 switches in the fabric (a dedicated logical port #37, for NVIDIA SHARP packets transmission, should be enabled and should be visible via UFM).
- UFM OpenSM should be running to discover the fabric topology.

NVIDIA SHARP AM is tightly dependent on OpenSM as it uses the topology discovered by OpenSM.

- NVIDIA SHARP AM should be enabled in UFM configuration by running:

```
[Sharp]
sharp_enabled = true
```

13.7.2.2 NVIDIA SHARP AM Configuration

By default, when running NVIDIA SHARP AM by UFM, there is no need to run further configuration. To modify the configuration of NVIDIA SHARP AM, you can edit the following NVIDIA SHARP AM configuration file: `/opt/ufm/files/conf/sharp/sharp_am.cfg`.

13.7.3 Running NVIDIA SHARP AM in UFM

➤ To run NVIDIA SHARP AM within UFM, do the following:

1. Make sure that the root GUID configuration file (`root_guid.conf`) exists in `conf/opensm`. This file is required for activating NVIDIA SHARP AM.
2. Enable NVIDIA SHARP in `conf/opensm/opensm.conf` OpenSM configuration file by running `"ib sm sharp enable"` or by setting the `sharp_enabled` parameter to 2:

```
# SHArP support
# 0: Ignore SHArP - No SHArP support
# 1: Disable SHArP - Disable SHArP on all supporting switches
# 2: Enable SHArP - Enable SHArP on all supporting switches
sharp_enabled 2
```

3. Make sure that port #6126 (on which NVIDIA SHARP AM is communicating with NVIDIA SHARP daemons) is not being used by any other application. If the port is being used, you can change it by modifying `smx_sock_port` parameter in the NVIDIA SHARP AM configuration file: `conf/sharp2/sharp_am.cfg` or via the command `"ib sharp port"`.
4. Enable NVIDIA SHARP AM in `conf/gv.cfg` UFM configuration file by running the command `"ib sharp enable"` or by setting the `sharp_enabled` parameter to true (it is false by default):

```
[Sharp]
sharp_enabled = true
```

5. (Optional) Enable NVIDIA SHARP allocation in `conf/gv.cfg` UFM configuration file by setting the `sharp_allocation_enabled` parameter to true (it is false by default):

```
[Sharp]
sharp_allocation_enabled = true
```

If the field `sharp_enabled`, and `sharp_allocation_enabled` are both set as true in `gv.cfg`, UFM sends an allocation (reservation) request to NVIDIA SHARP Aggregation Manager (AM) to allocate a list of GUIDs to the specified PKey when a new "Set GUIDs for PKey" REST API is called. If an empty list of GUIDs is sent, a PKEY deallocation request is sent to the SHARP AM.

NVIDIA SHARP allocations (reservations) allow SHARP users to run jobs on top of these resource (port GUID) allocations for the specified PKey. For more information, please refer to the *UFM REST API Guide* under Actions REST API → PKey GUIDs → Set/Update PKey GUIDs.

13.7.4 Operating NVIDIA SHARP AM with UFM

If NVIDIA SHARP AM is enabled, running UFM will run NVIDIA SHARP AM, and stopping UFM will stop NVIDIA SHARP AM.

- To start UFM with NVIDIA SHARP AM (enabled):

```
/etc/init.d/ufmd start
```

The same command applies to HA, using `/etc/init.d/ufmha`.

Upon startup of UFM or SHARP Aggregation Manager, UFM will resend all existing persistent allocation to SHARP AM.

- To stop UFM with NVIDIA SHARP AM (enabled):

```
/etc/init.d/ufmd stop
```

- To stop only NVIDIA SHARP AM while leaving UFM running:

```
/etc/init.d/ufmd sharp_stop
```

- To start only NVIDIA SHARP AM while UFM is already running:

```
/etc/init.d/ufmd sharp_start
```

Upon startup of UFM or SHARP Aggregation Manager, UFM will resend all existing persistent allocation to SHARP AM.

- To restart only NVIDIA SHARP AM while UFM is running:

```
/etc/init.d/ufmd sharp_restart
```

Upon startup of UFM or SHARP Aggregation Manager, UFM will resend all existing persistent allocation to SHARP AM.

- To display NVIDIA SHARP AM status while UFM is running:

```
/etc/init.d/ufmd sharp_status
```

13.7.5 Monitoring NVIDIA SHARP AM by UFMHealth

UFMHealth monitors SHARP AM and verifies that NVIDIA SHARP AM is always running. When UFMHealth detects that NVIDIA SHARP AM is down, it will try to re-start it, and will trigger an event to the UFM to notify it that NVIDIA SHARP AM is down.

13.7.6 Managing NVIDIA SHARP AM by UFM High Availability (HA)

In case of a UFM HA failover or takeover, NVIDIA SHARP AM will be started on the new master node using the same configuration that was used prior to the failover/takeover.

13.7.7 NVIDIA SHARP AM Logs

NVIDIA SHARP AM log file (sharp_am.log) at /opt/ufm/files/log.

NVIDIA SHARP AM log files are rotated by UFM logrotate mechanism.

13.7.8 NVIDIA SHARP AM Version

NVIDIA SHARP AM version can be found at /opt/ufm/sharp/share/doc/SHARP_VERSION.

13.8 Appendix - UFM SLURM Integration

Simple Linux Utility for Resource Management (SLURM) is a job scheduler for Linux and Unix-like kernels.

By integrating SLURM with UFM, you can:

- Assign partition keys (PKeys) to SLURM nodes that are assigned for specific SLURM jobs.
- Create SHARP reservations based on SLURM nodes assigned for specific SLURM jobs.

13.8.1 Prerequisites

- UFM 6.9.0 (or newer)
- Python 3.0 on SLURM controller
- UFM-SLURM integration files (provided independently)

13.8.2 Automatic Installation

A script is provided to install the UFM-SLURM integration automatically.

1. Using the SLURM controller, extract the UFM-SLURM integration tar file:

```
tar -xf ufm_slurm_integration.tar.gz
```

2. Run the installation script using root privileges.

```
sudo ./install.sh
```

13.8.3 Manual Installation

To install the UFM-SLURM integration manually:

1. Extract the UFM-SLURM integration tar file:

```
tar -xf ufm_slurm_integration.tar.gz
```

2. Copy the UFM-SLURM integration files to the SLURM controller folder.
3. Change the permissions of the UFM-SLURM integration files to 755.
4. Modify the SLURM configuration file on the SLURM controller, `/etc/slurm/slurm.conf`, and add/modify the following two parameters:

```
PrologSlurmctld=/etc/slurm/ufm-prolog.sh  
EpilogSlurmctld=/etc/slurm/ufm-epilog.sh
```

13.8.4 UFM SLURM Config File

The integration process uses a configuration file located at `/etc/slurm/ufm_slurm.conf`. This file is used to configure settings and attributes for UFM-SLURM integration.

Here are the contents:

Attribute Name	Description	Optionality
ufm_server	IP of UFM server to connect to	Mandatory
auth_type	Should be <code>token_auth</code> , or <code>basic_auth</code> If you select <code>basic_auth</code> , you need to set <code>ufm_server_user</code> and <code>ufm_server_pass</code> If you select <code>token_auth</code> , you need to set <code>token_auth</code>	Mandatory
ufm_server_user	Username of UFM server used to connect to UFM, if you set <code>auth_type=basic_auth</code>	Mandatory, depends on the <code>auth_type</code>
ufm_server_pass	UFM server user password	Mandatory, depends on the <code>auth_type</code>
token	Generated token when you set <code>uth_type</code> to <code>token_auth</code>	Mandatory, depends on the <code>auth_type</code>
pkey_allocation	By setting <code>pkey_allocation</code> to true, UFM SLURM Integration will use static Pkey assignment to create new Pkey, otherwise it will use the default management Pkey <code>0x7fff</code>	Mandatory, default is True.
pkey	Hexadecimal string between "0x0001"- "0x7ffe" exclusive	Optional, default is "0x7fff" (This is the default management pkey)
ip_over_ib	PKey is a member in a multicast group that uses IP over InfiniBand	Hidden param, default is True

Attribute Name	Description	Optionality
index0	If true, the API will store the PKey at index 0 of the PKey table of the GUID	Hidden param, default is False
sharp_allocation	By setting <code>sharp_allocation</code> to true, UFM SLURM Integration will create new SHARP allocation with all SLURM job IDs allocated to hosts	Mandatory, default is False
partially_alloc	By setting this to false, UFM will fail the SHARP allocation request if at least one node does not exist in the fabric	Optional, default is False
app_resources_limit	Application resources limitation	Hidden param, default is -1
log_file_name	Name of integration logging file	Optional

13.8.5 Configuring UFM for NVIDIA SHARP Allocation

To configure UFM for NVIDIA SHARP allocation/deallocation you must set `sharp_enabled` and `enable_sharp_allocation` to true in `gv.cfg` file.

13.8.5.1 Generate token_auth

If you set `auth_type=token_auth` in UFM SLURM's config file, you must generate a new token by logging into the UFM server and running the following `curl` command:

```
curl -H "X-Remote-User:admin" -XPOST http://127.0.0.1:8000/app/tokens
```

Then you must copy the generated token and paste it into the config file beside the `token_auth` parameter.

13.8.6 Prolog and Epilog

After submitting jobs on SLURM, there are two scripts that are automatically executed:

- `ufm-prolog.sh` - the prolog script is executed when a job is submitted and before running the job itself. It creates the partition key (pkey) assignment and/or NVIDIA SHARP reservation and assigns the SLURM job hosts for them.
- `ufm-epilog.sh` - the epilog script is executed when a job is complete. It removes the partition key (PKey) assignment and/or NVIDIA SHARP reservation and free the associated SLURM job hosts.

13.8.7 Integration Files

The integration use scripts and configuration files to work, which should be copied to SLURM controller `/etc/slurm`. Here is a list of these files:

File Name	Description
ufm-prolog.sh	Bash file which executes jobs related to UFM after the SLURM job is completed
ufm-epilog.sh	Bash file which executes jobs related to UFM before the SLURM job is executed
ufm_slurm.conf	UFM-SLURM integration configuration file
ufm_slurm_prolog.py	Python script file which creates the partition key (pkey) assignment and/or SHARP reservation when the prolog bash script is running
ufm_slurm_epilog.py	Python script file which removes partition key (pkey) assignment and/or SHARP reservation based on the SLURM job hosts.
ufm_slurm_utils.py	Utility Python file containing functions and utilities used by the integration process

13.8.8 Running UFM-SLURM Integration

Using the SLURM controller, execute the following commands to run your batch job:

```
$ sbatch -N4 slurm_demo.sh
Submitted batch job 1
```

N4 is the number of compute nodes used to run the jobs. `slurm_demo.sh` is the job batch file to be run.

The output and result are stored on the working directory `slurm-{id}.out` where `{id}` is the ID of the submitted job.

In the above example, after executing `sbatch` command, you can see that the submitted job ID is 1. Therefore, the output file would be stored in `slurm-1.out`.

Execute the following command to see the output:

```
$cat slurm-1.out
```

On the UFM side, a partition key (PKey) is created in case the `pkey_allocation` parameter is set to true in the configuration file, and the user provided the PKey name including the SLURM job IDs allocated to the hosts. Otherwise it will use the default management PKey.

In addition, the UFM-SLURM will create SHARM AM reservation in case the `sharp_allocation` parameter is set to true in the `ufm_slurm.conf` file.

After the SLURM job is completed, the UFM removes the job-related partition key (PKey) assignment and SHARP reservation, if they were created.

From the moment a job is submitted by the SLURM server until its completion, a log file named `/tmp/ufm_slurm.log` logs all of the actions and errors that occurred during the execution.

This log file can be changed by modifying the `log_file_name` parameter in `/etc/slurm /ufm_slurm.conf`.

13.9 Appendix - Switch Grouping

To facilitate the logical grouping of 1U switches into a "director-like switch" group, the UFM implements a special dedicated group of interconnected 1U switches based on a YAML configuration file. This group, which is of type "superswitch", only includes 1U switches connected to each other, with some functioning as lines and others as spines.

To access the configuration file for superswitches, users can define the path in the [SubnetManager] section of the `gv.cfg` file, using the variable name `super_switch_config_file_path`. For instance, the path can be specified as follows: `super_switch_config_file_path=/opt/ufm/files/conf/super_switches_configuration.cfg`.

It is important to note that the file must be located in the `/opt/ufm/files` file tree, as it should be replicated between master and slave UFM servers in a high-availability configuration.

The structure of the superswitch definition should be as follows, based on the following example:

```
superswitch:
- name: "Marlin01" # Director switch name
  description: "primary dc switch" # Free text with the customer facing description
  location: "US, NC, DC01" # Director switch location (global location, includes all racks/switches)
  racks: # Director switch Racks definitions
    #Rack definition
    - name: "rack A" # Director switch rack name
      location:
        dc-grid-row: "A" # formalized rack location in DC
        dc-grid-column: "1" # formalized
        comments: "left-most rack in the line" #Cutomer facing comment on the rack
      leaves: # List of Director switch leaves (for the rack specified)
        - guid: "0x043f720300922a00" #required filed. Switch GUID.
          location-u: 1 # required field. Device location in rack: "U#"
          description: "MF0;gorilla-01:MQM9700/U1" # optional field.
        - guid: "0x043f720300899cc0" #required filed. Switch GUID.
          location-u: XX # required field. Device location in rack: "U#"
          description: "MF0;gorilla-01:MQM9700/U2" # optional field.
      spines: # List of Director switch spines (for the rack specified)
        - guid: "0x043f720900922a00" #required filed. Switch GUID.
          location-u: 10 # required field. Device location in rack: "U#"
          description: "MF0;gorilla-02:MQM9700/U1" # optional field.
        - guid: "0x043f720900899cc0" #required filed. Switch GUID.
          location-u: XX # required field. Device location in rack: "U#"
          description: "MF0;gorilla-02:MQM9700/U2" # optional field.
- name: "Marlin02" # Director switch name
  description: "primary dc switch" # Free text with the customer facing description
  location: "US, NC, DC01" # Director switch location (global location, includes all racks/switches)
  racks: # Director switch Racks definitions
    #Rack definition
    - name: "rack B" # Director switch rack name
      location:
        dc-grid-row: "B" # formalized rack location in DC
        dc-grid-column: "1" # formalized
        comments: "left-most rack in the line" #Cutomer facing comment on the rack
      leaves: # List of Director switch leaves (for the rack specified)
        - guid: "0x093f720300922a00" #required filed. Switch GUID.
          location-u: 1 # required field. Device location in rack: "U#"
          description: "MF0;gorilla-03:MQM9700/U1" # optional field.
        - guid: "0x093f720300899cc0" #required filed. Switch GUID.
          location-u: XX # required field. Device location in rack: "U#"
          description: "MF0;gorilla-03:MQM9700/U2" # optional field.
      spines: # List of Director switch spines (for the rack specified)
        - guid: "0x093f720900922a00" #required filed. Switch GUID.
          location-u: 10 # required field. Device location in rack: "U#"
          description: "MF0;gorilla-04:MQM9700/U1" # optional field.
        - guid: "0x093f720900899cc0" #required filed. Switch GUID.
          location-u: XX # required field. Device location in rack: "U#"
          description: "MF0;gorilla-04:MQM9700/U2" # optional field
```

13.9.1 UI Presentation

The logical grouping can be accessed under the "Groups" view, specifically listed as "SuperSwitch group" type.

Groups Local Time [redacted] ? admin

All + New Displayed Columns CSV

Severity	Name ↑	Description	Type
Info	1U Switches	Includes all 1U Switches that exist in the fabric	General
Info	Alarmed Devices	Devices with alarms	General
Info	Devices Pending FW Transceivers Reset	Includes all Devices that pending FW transceivers reset t...	General
Info	Gateway Devices	Includes all Gateway Devices that exist in the fabric	General
Info	Marlin01	SuperSwitch group	SuperSwitch
Info	Marlin02	SuperSwitch group	SuperSwitch
Info	Modular Switches	Includes all Modular Switches that exist in the fabric	General
Info	Routers	Includes all Router Devices that exist in the fabric	General
Info	Servers	Includes all Hosts that exist in the fabric	General
Info	Servers With DPU	Includes all Devices that has DPU that exist in the fabric	General
Info	Suppressed Devices	No event notifications issued	General
Info	Switches	Includes all Switches that exist in the fabric	General

Viewing 1-12 of 12 [Navigation icons] 20

Upon selecting the group type SuperSwitch, additional columns containing information related to the SuperSwitch are added to the details view.

Groups Local Time [redacted] Last Update [redacted] ? admin

All + New Displayed Columns CSV

Severity	Name ↑	Description	Type
Info	1U Switches	Includes all 1U Switche...	General
Info	Alarmed Devices	Devices with alarms	General
Info	Devices Pending FW Tr...	Includes all Devices tha...	General
Info	Gateway Devices	Includes all Gateway D...	General
Info	Marlin01	SuperSwitch group	SuperSwitch
Info	Marlin02	SuperSwitch group	SuperSwitch
Info	Modular Switches	Includes all Modular S...	General
Info	Routers	Includes all Router Dev...	General
Info	Servers	Includes all Hosts that ...	General
Info	Servers With DPU	Includes all Devices tha...	General
Info	Suppressed Devices	No event notifications i...	General
Info	Switches	Includes all Switches t...	General

Viewing 1-12 of 12 [Navigation icons] 20

Marlin01 - Members Displayed Columns

Name ↑	GUID	IP	Type	Descri...	Locati...	Rack
gorilla-01	0x043f72...	0.0.0.0	leaf	MF0:gori...	1	rack A
gorilla-01	0x043f72...	0.0.0.0	leaf	MF0:gori...	XX	rack A
gorilla-07	0x073f72...	0.0.0.0	spine	MF0:gori...	10	rack A
gorilla-07	0x073f72...	0.0.0.0	spine	MF0:gori...	XX	rack A

Viewing 1-4 of 4 [Navigation icons] 20

An icon for the SuperSwitch group in its collapsed view exists on the network map.

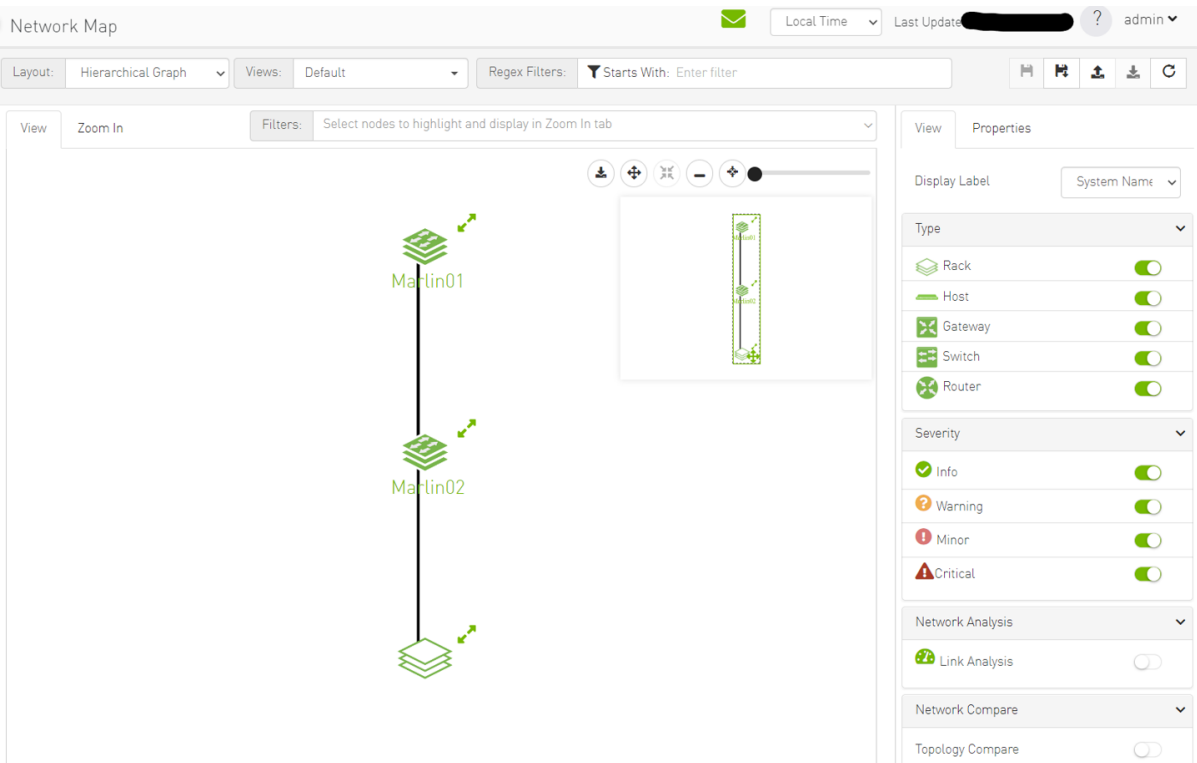

Upon selecting the SuperSwitch group, all of its properties can be viewed in the details view.

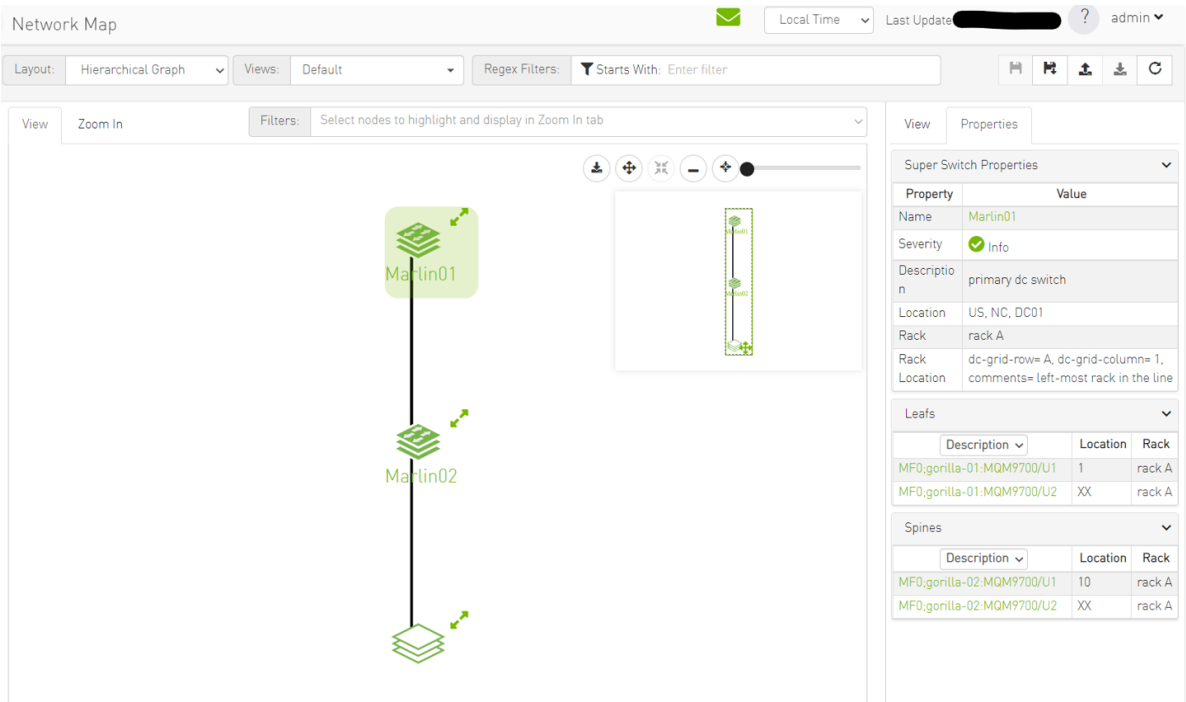

Expanding the SuperSwitch group icon displays all the switches included in the group as separate 1U switches, along with their respective properties.

Network Map

Layout: Hierarchical Graph Views: Default Regex Filters: Starts With: Enter filter

View Zoom In Filters: Select nodes to highlight and display in Zoom In tab

View Properties

Super Switch Properties

Property	Value
Name	Marlin01
Severity	Info
Description	primary dc switch
Location	US, NC, DC01
Rack	rack A
Rack Location	dc-grid-row= A, dc-grid-column= 1, comments= left-most rack in the line

Leaves

Description	Location	Rack
MF0:gorilla-01:MQM9700/U1	1	rack A
MF0:gorilla-01:MQM9700/U2	XX	rack A

Spines

Description	Location	Rack
MF0:gorilla-02:MQM9700/U1	10	rack A
MF0:gorilla-02:MQM9700/U2	XX	rack A

Network Map

Layout: Hierarchical Graph Views: Default Regex Filters: Starts With: Enter filter

View Zoom In Filters: Select nodes to highlight and display in Zoom In tab

View Properties

System Properties

Property	Value
Name	gorilla-07
IP	0.0.0.0
GUID	0x073f720300922a00
Type	switch
Model	MQM9700
Severity	Info
FW Version	N/A
PSID	N/A
Total Alarms	0
Temperature	N/A
Description	MQM9700
SW Version	N/A

System Ports

Port Name
gorilla-07:1
gorilla-07:13
gorilla-07:14

On the devices view, switches that are part of the SuperSwitch group are marked with an additional icon that indicates their role in the group. The "S" icon denotes spines, while the "L" icon denotes lines.

Devices Local Time Last Update [redacted] admin

All Types All Groups Displayed Columns CSV

Severity	Name	GUID	Type	Model	IP	Firmware Version
Info	gorilla-01	0x043f720300922a00	switch	MQM9700	0.0.0.0	
Info	gorilla-07	0x073f720300922a00	switch	MQM9700	0.0.0.0	
Info	gorilla-08	0x083f720300922a00	switch	MQM9700	0.0.0.0	
Info	gorilla-02	0x093f720300922a00	switch	MQM9700	0.0.0.0	
Info	gorilla-01	0x043f720300899cc0	switch	MQM9700	0.0.0.0	
Info	gorilla-07	0x073f720300899cc0	switch	MQM9700	0.0.0.0	
Info	gorilla-08	0x083f720300899cc0	switch	MQM9700	0.0.0.0	
Info	gorilla-02	0x093f720300899cc0	switch	MQM9700	0.0.0.0	
Info	r-ufm50	0x248a0703008fa050	host		0.0.0.0	

Viewing 1-9 of 9

Selecting a switch that belongs to the SuperSwitch group in the properties view allows you to view all the switch properties related to the SuperSwitch group.

Devices Local Time Last Update [redacted] admin

Name	GUID	Type	Model	IP	Firmwa...
gorilla-01	0x043f720...	switch	MQM97	0.0.0.0	
<input checked="" type="checkbox"/>	gorilla-07	0x073f720...	switch	MQM97	0.0.0.0
gorilla-08	0x083f720...	switch	MQM97	0.0.0.0	
gorilla-02	0x093f720...	switch	MQM97	0.0.0.0	
gorilla-01	0x043f720...	switch	MQM97	0.0.0.0	
gorilla-07	0x073f720...	switch	MQM97	0.0.0.0	
gorilla-08	0x083f720...	switch	MQM97	0.0.0.0	
gorilla-02	0x093f720...	switch	MQM97	0.0.0.0	
r-ufm50	0x248a07...	host		0.0.0.0	

0x073f720300922a00 - Device Information

General Ports Cables Groups Alarms Events Inventory

Device Access Super Switch

Property	Value
Description	MF0:gorilla-02:MQM9700/U1
Location	10
Type	spine
Rack Name	rack A
Rack Location	dc-grid-row=A, dc-grid-column=1, comment...
Super Switch Name	Martin01

Each SuperSwitch definition can include one or more racks where each embedded rack can include multiple leaves and spines switches.

13.10 Appendix - Device Management Feature Support

The following table describes the management features available on supported devices.

Feature	10 Gb Ethernet Gateway Module	Grid Director 4700/4200/4036/4036E v3.5	Managed IS5000 Switches	Managed SX6000 Switches	Externally Managed IS5000 / SX6000 Switches	Gateway BX5020	HP Class	Linux Hosts	Windows Hosts

Discovery									
IB L2 Discovery	Yes	Yes	Yes	Yes	Yes	Yes	Yes	Yes	Yes
Advanced Discovery (IP, hostname, Hosts: CPU, memory, FW version)	Yes	Yes	No	Yes	No	No	No	Yes with UFM Host Agent	No
Ethernet access Management interface	Yes	Yes	Yes	Yes	No	No	No	Yes	Yes
Provisioning/ Configuration									
IB Partitioning (pkey)	Yes	Yes	Yes	Yes	Yes	Yes	Yes	Yes	Yes
QoS: SL (SM configuration)	N/A	Yes	Yes	Yes	Yes	Yes	Yes	Yes	Yes
QoS: Rate Limit (SM configuration)	N/A	Yes	Yes	Yes	Yes	Yes	Yes	Yes	Yes
Interface/VIF Configuration (IP, hostname, mtu, Bonding)	N/A	N/A	N/A	N/A	N/A	No	N/A	Yes with UFM Host Agent	No
Device Monitoring									
Device Resources: CPU, Memory, Disk	No	Yes	No	No	No	No	No	Yes with UFM Host Agent	No
Get device alerts (Temperature, PS, Fan) Note: This feature is not supported on Switch-X switches.	Yes	Yes	No	Yes	Yes	No	No	No	No
L1 (Physical Port) - Monitoring	Yes	Yes	Yes	Yes	Yes	Yes	Yes	Yes	Yes

L2-3 (Interface/VIF) - Monitoring	No	No	No	No	No	No	No	Yes with UFM Host Agent	No
Congestion Monitoring per port (enables congestion map)	No	Yes	Yes	Yes	Yes	Yes	Yes	Yes	Yes
Congestion Monitoring per flow (Advanced Package)	No	Yes	No	No	No	No	No	No	No
Device Management									
Add/remove to/from Rack	Yes	Yes	Yes	Yes	Yes	Yes	Yes	Yes	Yes
Add/remove to/from Logical Server	N/A	N/A	N/A	N/A	N/A	N/A	N/A	Yes	Yes
View/clear Alarms	Yes	Yes	Yes	Yes	Yes	Yes	Yes	Yes	Yes
SSH terminal to device	Yes	Yes	Yes	Yes	No	No	No	Yes	Yes
Power On	No	No	No	No	No	No	No	Yes with IPMI	No
Reboot	No	No	No	Yes (SX3606 only)	No	No	No	Yes with IPMI	No
Shutdown	No	No	No	No	No	No	No	Yes with IPMI	No
Port Enable/Disable	No	Yes	Yes	Yes	Yes	Yes	Yes	Yes	Yes
Firmware Upgrade (HCA & switch)	No	Yes	No	Yes (Upon SW upgrade - SX6036 only)	No	No	No	Yes	No
Inband Firmware Upgrade (over InfiniBand connection)	No	No	No	No	Yes	No	No	Yes	Yes
Software Upgrade (OFED & switch)	No	Yes	No	Yes (SX3606 only)	No	No	No	Yes with UFM Host Agent	No

Protocols									
Communication UFM Server - Device	IB/SNMP	IB/UDP/SSH	IB	IB/HTTP/SSH	IB	IB	IB	IB, SSH, IPMI, UDP	IB

1. For a full list of supported IS5000 switches, see [Supported IS5000 Switches](#).
2. QoS Rate Limit (SM configuration): On ConnectX HCAs-only, for hosts.
3. XmitWait counter monitoring requires ConnectX HCAs with firmware version 2.6 and above.
4. This feature requires that the IP address is configured.

14 Document Revision History

Release	Date	Description
6.18.0	Aug 14, 2024	<p>Updated:</p> <ul style="list-style-type: none"> • Changes and New Features • Bug Fixes in This Release • Known Issues in This Release • Installation Notes • Installing UFM Server Software - Added a note on Docker installation via SNAP on Ubuntu OSs • Data Streaming • Installing UFM on Docker Container - High Availability Mode - Added two pre-deployment requirements • REST-RDMA Plugin - Updated "Authenticated Remote ibdiagnet Request" • Topology Compare Tab and Events & Alarms - Updated screenshots • Appendix - Supported Port Counters and Events - Added 1605 and 1606 alarm IDs • Autonomous Link Maintenance (ALM) Plugin - Added "Data Filter" and "Metric Filter" ALM jobs • UFM Telemetry Manager (UTM) Plugin - Added an important note on UFM credentials, added instructions on accessing UTM API commands and "Command List" • GNMI-Telemetry Plugin <p>Added:</p> <ul style="list-style-type: none"> • Excluding Unhealthy Ports from Fabric Health Report • UFM Configuration Files Based on Fabric Size • Exposing Performance Histogram Counters • Plugins Bundle • UFM Plugins Management • Key Performance Indexes (KPI) Plugin • UFM Light Plugin
6.17.2	Jun 24, 2024	Added bug fix (Ref #3912416) to Bug Fixes in This Release
	Jun 26, 2024	<p>Updated:</p> <ul style="list-style-type: none"> • Upgrading UFM on Bare Metal Server • Upgrading UFM on Docker Container • GNMI-Telemetry Plugin • Fast-API Plugin
6.17.1	May 28, 2024	<p>Updated:</p> <ul style="list-style-type: none"> • Bug Fixes in This Release • Known Issues in This Release <p>Added Fast-API Plugin</p>
	Jun 17, 2024	<ul style="list-style-type: none"> • Updated the Fast-API Plugin name • Updated Enabling UFM Authentication Server

Release	Date	Description
6.17.0	May 7, 2024	<p>Introduced a minor reorganization of the document.</p> <p>Updated:</p> <ul style="list-style-type: none"> • Changes and New Features • Bug Fixes in This Release • GNMI-Telemetry Plugin • Events Policy - Updated event policy parameters • Inventory Window • Devices Window • UFM Health Tab • UFM System Dump Tab • Device Access - Updated screenshot and parameters • Configurations of the UFM Authentication Server - Updated that it is turned on by default • Autonomous Link Maintenance (ALM) Plugin • PDR Deterministic Plugin - updated the configuration table • Low-Frequency (Secondary) Telemetry Fields • Appendix - Supported Port Counters and Events - Added and removed alarm IDs <p>Added:</p> <ul style="list-style-type: none"> • Events and Alarms • Reports • Telemetry2 • Events Policy Simulation • UFM Telemetry Manager (UTM) Plugin • UFM Consumer Plugin
	May 13, 2024	<p>Updated:</p> <ul style="list-style-type: none"> • Known Issues in This Release - Added issue #3862847 • Installation Notes - Updated the latest tested FW versions in Supported NVIDIA Externally/Internally Managed Switches • PDR Deterministic Plugin
	May 24, 2024	<p>Updated:</p> <ul style="list-style-type: none"> • Known Issues in This Release - Added issue #3872303 • UFM Telemetry Fluentd Streaming (TFS) Plugin • GNMI-Telemetry Plugin • PDR Deterministic Plugin

Release	Date	Description
6.16.0	Feb 8, 2024	<p>Updated:</p> <ul style="list-style-type: none"> • Changes and New Features • Bug Fixes in This Release • Installation Notes • Secondary Telemetry - Added the secondary_slvl_support flag and information on the default counters and added Secondary Telemetry Exposing IPv6 Counters • PDR Deterministic Plugin - Updated instructions • Link Analysis - Updated GUI screenshots • Device Cable Tab - Updated GUI screenshots • Cables Window - Updated GUI screenshots • Packet Level Monitoring Collector (PMC) Plugin - Updated overview and GUI screenshots • General Tab, Inventory Tab and Inventory Window - Updated GUI screenshots • SM Congestion Control Configuration - Updated GUI screenshot • Autonomous Link Maintenance (ALM) Plugin - Added GUI screenshots in ALM UI • Appendix - UFM Subnet Manager Default Properties - Updated the max_op_vls from 3 to 2. <p>Added:</p> <ul style="list-style-type: none"> • Kerberos Authentication and Enabling Kerberos Authentication • Secondary Telemetry Exposing IPv6 Counters • Dynamic Telemetry • Configuring Syslog • Configuring UFM Logging • Appendix - OpenSM Configuration Files for Congestion Control
	Mar 6, 2024	<p>Updated:</p> <ul style="list-style-type: none"> • Troubleshooting • Known Issues in This Release • Installation Notes
6.15.2	Jan 4, 2024	<p>Updated:</p> <ul style="list-style-type: none"> • Changes and New Features • Known Issues in This Release
	Jan 23, 2024	Added a note to Installation Notes about the UFM SM version
6.15.1	Dec 14, 2023	<p>Updated:</p> <ul style="list-style-type: none"> • Bug Fixes in This Release • Known Issues in This Release • Supported NVIDIA Internally Managed Switches - Removed MTX6100, MTX6240 and MTX6280 switches and the SX6036G (FDR) gateway • Installation Notes - Updated with the new MFT package version • System Requirements - Added MLNX_OFED23.x • Unsupported Functionalities/Features <p>Added:</p> <p>Cable Validation Report in Subnet Merger</p>
	Dec 19, 2023	<ul style="list-style-type: none"> • Updated Changes and New Features • Added a Known issue to Bug Fixes in This Release

Release	Date	Description
6.15.0	Nov 5, 2023	<p>Updated:</p> <ul style="list-style-type: none"> • Changes and New Features • Bug Fixes in This Release • Azure Authentication Login Page - Introduced new Azure authentication login page • Enabling Azure AD Authentication - Added further instructions • UFM Logs Tab - Added log occurrences display <p>Added</p> <ul style="list-style-type: none"> • Events History • Device Status Events • Link Status Events • GNMI-Telemetry Plugin • In Secondary Telemetry, added instructions on Exposing Switch Aggregation Nodes Telemetry and Stopping Telemetry Endpoint Using CLI Command • UFM Authentication Server • Enabling UFM Authentication Server • Low-Frequency (Secondary) Telemetry Fields
6.14.1	Aug 31, 2023	<p>Updated:</p> <ul style="list-style-type: none"> • Changes and New Features • Bug Fixes in This Release
	Oct 17, 2023	<p>Updated:</p> <ul style="list-style-type: none"> • System Requirements
6.14.0	Aug 10, 2023	<p>Updated:</p> <ul style="list-style-type: none"> • Changes and New Features • Bug Fixes in This Release • Known Issues in This Release • Plugin Management • Secondary Telemetry • PDR Deterministic Plugin - Updated step 3 in "Deployment". • REST-RDMA Plugin • NDT Plugin • Autonomous Link Maintenance (ALM) Plugin • Appendix - Supported Port Counters and Events - Added alarm ID #134, 1602 and 1603 and status column for all alarm IDs. <p>Added:</p> <ul style="list-style-type: none"> • Disabling Rest Roles Access Control • Enabling Azure AD Authentication • Azure AD Authentication • Health Policy Management • Rest Roles Access Control • UFM Factory Reset
6.13.1	May 18, 2023	<p>Updated:</p> <ul style="list-style-type: none"> • Changes and New Features • Bug Fixes in This Release

Release	Date	Description
6.13.0	May 5, 2023	<p>Updated:</p> <ul style="list-style-type: none"> Changes and New Features Bug Fixes in This Release Known Issues in This Release Email - Added time zone preference NDT Plugin UFM Telemetry Fluentd Streaming (TFS) Plugin - Updated REST API UFM System Dump Tab Appendix - Supported Port Counters and Events <p>Added:</p> <ul style="list-style-type: none"> Multi-Subnet UFM Enable Network Fast Recovery NDT Format Merger Subnet Merger UI Added the following Plugins: <ul style="list-style-type: none"> UFM Bright Cluster Integration Plugin UFM Cyber-AI Plugin Autonomous Link Maintenance (ALM) Plugin ClusterMinder Plugin Sysinfo Plugin SNMP Plugin Packet Level Monitoring Collector (PMC) Plugin PDR Deterministic Plugin
	May 9, 2023	<p>Updated</p> <ul style="list-style-type: none"> Known Issues in This Release Appendix - Enhanced Quality of Service - Updated notes and example
6.12.1	Feb 19, 2023	<p>Updated</p> <ul style="list-style-type: none"> Changes and New Features Bug Fixes in This Release Known Issues in This Release
	Mar 1, 2023	Updated Changes and New Features
	Mar 16, 2023	Updated Changes and New Features - Added MFT package integration details
	Mar 27, 2023	Updated UFM Server Communication with Externally Managed Switches
6.12.0	Feb 2, 2023	<p>Updated:</p> <ul style="list-style-type: none"> Changes and New Features Bug Fixes in This Release Known Issues in This Release Configuring Partial Switch ASIC Failure Events Updated example in Multi-port SM UFM System Dump Tab Appendix - Used Ports Appendix - UFM SLURM Integration <p>Added:</p> <ul style="list-style-type: none"> Added a note under Ports Window Added a note under Unhealthy Ports Window Delegate Authentication to a Proxy <p>Removed:</p> <ul style="list-style-type: none"> UFM Logical Elements tab from the Web UI
	Feb 6, 2023	Updated Troubleshooting

Release	Date	Description
6.11.1	Dec 1, 2022	Updated: <ul style="list-style-type: none"> • Changes and New Features to include the upgrade of NVIDIA SHARP SW version • Installation Notes • Known Issues in This Release • Troubleshooting
	Dec 19, 2022	Updated Changes and New Features

15 EULA, Legal Notices and 3rd Party Licenses

15.1 Legal Notice

15.2 Third-Party Licenses

15.3 License Agreement

This license is a legal agreement (“Agreement”) between you and Mellanox Technologies, Ltd. (“NVIDIA”) and governs the use of the NVIDIA UFM software and materials provided hereunder (“SOFTWARE”). If you are entering into this Agreement on behalf of a company or other legal entity, you represent that you have the legal authority to bind the entity to this Agreement, in which case “you” will mean the entity you represent.

You agree to use the SOFTWARE only for purposes that are permitted by (a) this license, and (b) any applicable law, regulation, or generally accepted practices or guidelines in the relevant jurisdictions.

1. License. Subject to the terms and conditions of this Agreement and payment of applicable subscription fee, NVIDIA MELLANOX grants you a personal, non-exclusive, non-sublicensable (except as provided in this Agreement), non-transferable, non-commercial license to install and use the Software for your internal business purposes for configuring, operating, and managing your InfiniBand network and not for further distribution.
2. Authorized Users. You may allow access and use of the Software to: (i) employees and contractors of your entity provided that the access and use of the Software is made from your secure network to perform work on your behalf and (ii) If you are an academic institution you may allow users enrolled or employed by the academic institution to access and use the Software from your secure network (“Authorized Users”). You hereby undertake to be responsible and liable for any non-compliance with the terms of this Agreement by your Authorized Users. You further agree to immediately resolve any non-compliance by your Authorized Users of which you become aware and endeavor take necessary steps to prevent any new occurrences.
3. Limitations Your license to use the SOFTWARE is restricted as follows:
 - 3.1 The SOFTWARE is licensed for your use in systems with the registered NVIDIA Host Channel Adapter (HCA) Products or related adapter products.
 - 3.2 Each copy of the SOFTWARE shall be limited to the number of HCAs indicated in the applicable purchase order.
 - 3.3 You may use software back-up utilities to make one back-up copy of the Software Product. You may use the back-up copy solely for archival purposes
 - 3.4 You may not use the SOFTWARE in conjunction with a number of managed nodes or managed devices which is beyond the allowable limit or copy the SOFTWARE on additional hardware. You shall not use any features which are not included in the scope of this Agreement as described in the accompanying documentation.
 - 3.5 You may not reverse engineer, decompile or disassemble, or remove copyright or other proprietary notices from any portion of the SOFTWARE or copies of the SOFTWARE.
 - 3.6 You may not disclose the results of benchmarking, competitive analysis, regression, or performance data relating to the SOFTWARE without the prior written permission from NVIDIA

Mellanox.

3.7 Except as expressly provided in this license, you may not copy, sell, rent, sublicense, transfer, distribute, modify, or create derivative works of any portion of the SOFTWARE. For clarity, unless, you have an agreement with NVIDIA Mellanox for this purpose you may not distribute or sublicense the SOFTWARE as a stand-alone product.

3.8 You may not bypass, disable, or circumvent any technical limitation, encryption, security, digital rights management, or authentication mechanism in the SOFTWARE.

3.9 You may not use the Software in any manner that would cause it to become subject to an open source software license. As examples, licenses that require as a condition of use, modification, and/or distribution that the Software be: (i) disclosed or distributed in source code form; (ii) licensed for the purpose of making derivative works; or (iii) redistributable at no charge.

3.10 Unless you have an agreement with NVIDIA Mellanox for this purpose, you may not use the Software with any system or application where the use or failure of the system or application can reasonably be expected to threaten or result in personal injury, death, or catastrophic loss. Examples include use in avionics, navigation, military, medical, life support or other life critical applications. NVIDIA Mellanox does not design, test, or manufacture the Software for these critical uses and NVIDIA Mellanox shall not be liable to you or any third party, in whole or in part, for any claims or damages arising from such uses.

3.11 You agree to defend, indemnify and hold harmless NVIDIA Mellanox and its affiliates, and their respective employees, contractors, agents, officers and directors, from and against any and all claims, damages, obligations, losses, liabilities, costs or debt, fines, restitutions and expenses (including but not limited to attorney's fees and costs incident to establishing the right of indemnification) arising out of or related to your use of the Software outside of the scope of this license, or not in compliance with its terms.

4. Updates. NVIDIA Mellanox may, at its option, make available patches, workarounds, or other updates to this Software. Unless the updates are provided with their separate governing terms, they are deemed part of the Software licensed to you as provided in this license. You agree that the form and content of the Software that NVIDIA Mellanox provides may change without prior notice to you. While NVIDIA Mellanox generally maintains compatibility between versions, NVIDIA Mellanox may in some cases make changes that introduce incompatibilities in future versions of the SOFTWARE.
5. Pre-Release Versions. Software versions identified as alpha, beta, preview, early access or otherwise as pre-release may not be fully functional, may contain errors or design flaws, and may have reduced or different security, privacy, availability, and reliability standards relative to commercial versions of NVIDIA Mellanox software and materials. You may use a pre-release Software version at your own risk, understanding that these versions are not intended for use in production or business-critical systems. NVIDIA Mellanox may choose not to make available a commercial version of any pre-release Software. NVIDIA Mellanox may also choose to abandon development and terminate the availability of a pre-release Software at any time without liability.
6. Third-Party Components. The Software may include third-party components with separate legal notices or terms as may be described in proprietary notices accompanying the Software or as provided in an Exhibit to this Agreement. If and to the extent there is a conflict between the terms in this license and the third-party license terms, the third-party terms control only to the extent necessary to resolve the conflict. For details regarding the third party components, please review Exhibit A.

7. OWNERSHIP

7.1 NVIDIA Mellanox or its licensors reserves all rights, title, and interest in and to the Software not expressly granted to you under this license NVIDIA Mellanox and its suppliers hold all rights, title, and interest in and to the Software, including their respective intellectual property rights. The Software is copyrighted and protected by the laws of the United States and other countries, and international treaty provisions.

7.2 Subject to the rights of NVIDIA Mellanox and its suppliers in the Software, you hold all rights, title, and interest in and to your applications and your derivative works of the sample source code delivered in the Software including their respective intellectual property rights.

8. You may, but are not obligated to, provide to NVIDIA Mellanox Feedback. "Feedback" means suggestions, fixes, modifications, feature requests or other feedback regarding the Software. Feedback, even if designated as confidential by you, shall not create any confidentiality obligation for NVIDIA Mellanox. NVIDIA Mellanox and its designees have a perpetual, non-exclusive, worldwide, irrevocable license to use, reproduce, publicly display, modify, create derivative works of, license, sublicense, and otherwise distribute and exploit Feedback as NVIDIA Mellanox sees fit without payment and without obligation or restriction of any kind on account of intellectual property rights or otherwise.
9. No Warranties. THE SOFTWARE IS PROVIDED AS-IS. TO THE MAXIMUM EXTENT PERMITTED BY APPLICABLE LAW NVIDIA MELLANOX AND ITS AFFILIATES EXPRESSLY DISCLAIM ALL WARRANTIES OF ANY KIND OR NATURE, WHETHER EXPRESS, IMPLIED OR STATUTORY, INCLUDING, BUT NOT LIMITED TO, WARRANTIES OF MERCHANTABILITY, NON-INFRINGEMENT, OR FITNESS FOR A PARTICULAR PURPOSE. NVIDIA MELLANOX DOES NOT WARRANT THAT THE SOFTWARE WILL MEET YOUR REQUIREMENTS OR THAT THE OPERATION THEREOF WILL BE UNINTERRUPTED OR ERROR-FREE, OR THAT ALL ERRORS WILL BE CORRECTED.
10. Limitations of Liability. TO THE MAXIMUM EXTENT PERMITTED BY APPLICABLE LAW NVIDIA MELLANOX AND ITS AFFILIATES SHALL NOT BE LIABLE FOR ANY SPECIAL, INCIDENTAL, PUNITIVE OR CONSEQUENTIAL DAMAGES, OR FOR ANY LOST PROFITS, PROJECT DELAYS, LOSS OF USE, LOSS OF DATA OR LOSS OF GOODWILL, OR THE COSTS OF PROCURING SUBSTITUTE PRODUCTS, ARISING OUT OF OR IN CONNECTION WITH THIS LICENSE OR THE USE OR PERFORMANCE OF THE SOFTWARE, WHETHER SUCH LIABILITY ARISES FROM ANY CLAIM BASED UPON BREACH OF CONTRACT, BREACH OF WARRANTY, TORT (INCLUDING NEGLIGENCE), PRODUCT LIABILITY OR ANY OTHER CAUSE OF ACTION OR THEORY OF LIABILITY, EVEN IF NVIDIA MELLANOX HAS PREVIOUSLY BEEN ADVISED OF, OR COULD REASONABLY HAVE FORESEEN, THE POSSIBILITY OF SUCH DAMAGES. IN NO EVENT WILL NVIDIA MELLANOX AND ITS AFFILIATES TOTAL CUMULATIVE LIABILITY UNDER OR ARISING OUT OF THIS LICENSE EXCEED US\$10.00. THE NATURE OF THE LIABILITY OR THE NUMBER OF CLAIMS OR SUITS SHALL NOT ENLARGE OR EXTEND THIS LIMIT.
11. T Your rights under this license will terminate automatically without notice from NVIDIA Mellanox (a) upon expiration of your subscription, (b) if you fail to comply with any term and condition of this license including non-payment of applicable fees, or (c) if you commence or participate in any legal proceeding against NVIDIA Mellanox with respect to the Software. NVIDIA Mellanox may terminate this license with advance written notice to you, if NVIDIA Mellanox decides to no longer provide the Software in a country or, in NVIDIA Mellanox's sole discretion, the continued use of it is no longer commercially viable. Upon any termination of this license, you agree to promptly discontinue use of the Software and destroy all copies in your possession or control. All provisions of this license will survive termination, except for the license granted to you.

12. Product Support. Product support for the Software Product is provided by NVIDIA Mellanox or its authorized agents under the applicable subscription license, in accordance with NVIDIA Mellanox's standard support and maintenance terms and conditions. For product support, please refer to NVIDIA Mellanox support number provided in the documentation.
13. Applicable Law. This license will be governed in all respects by the laws of the United States and of the State of Delaware, without regard to the conflicts of laws principles. The United Nations Convention on Contracts for the International Sale of Goods is specifically disclaimed. You agree to all terms of this license in the English language. The state or federal courts residing in Santa Clara County, California shall have exclusive jurisdiction over any dispute or claim arising out of this license. Notwithstanding this, you agree that NVIDIA Mellanox shall still be allowed to apply for injunctive remedies or urgent legal relief in any jurisdiction.
14. No Assignment. This license and your rights and obligations thereunder may not be assigned by you by any means or operation of law without NVIDIA Mellanox's permission. Any attempted assignment not approved by NVIDIA MELLANOX in writing shall be void and of no effect. NVIDIA Mellanox may assign, delegate, or transfer this license and its rights and obligations, and if to a non-affiliate you will be notified.
15. E The Software is subject to United States export laws and regulations. You agree to comply with all applicable U.S. and international export laws, including the Export Administration Regulations (EAR) administered by the U.S. Department of Commerce and economic sanctions administered by the U.S. Department of Treasury's Office of Foreign Assets Control (OFAC). These laws include restrictions on destinations, end-users and end-use. By accepting this license, you confirm that you are not currently residing in a country or region currently embargoed by the U.S. and that you are not otherwise prohibited from receiving the Software.
16. Government Use. The Software is, and shall be treated as being, "Commercial Items" as that term is defined at 48 CFR § 2.101, consisting of "commercial computer software" and "commercial computer software documentation", respectively, as such terms are used in, respectively, 48 CFR § 12.212 and 48 CFR §§ 227.7202 & 252.227-7014(a)(1). Use, duplication or disclosure by the U.S. Government or a U.S. Government subcontractor is subject to the restrictions in this license pursuant to 48 CFR § 12.212 or 48 CFR § 227.7202. In no event shall the US Government user acquire rights in the Software beyond those specified in 48 C.F.R. 52.227-19(b)(1)-(2).
17. Please direct your legal notices or other correspondence to NVIDIA Corporation, 2788 San Tomas Expressway, Santa Clara, CA, 95051 United States of America, Attention: Legal Department and to: NBU-Legal_Notices@exchange.nvidia.com
18. Entire Agreement. This license is the final, complete, and exclusive agreement between the parties relating to the subject matter of this license and supersedes all prior or contemporaneous understandings and agreements relating to this subject matter, whether oral or written. If any court of competent jurisdiction determines that any provision of this license is illegal, invalid, or unenforceable, the remaining provisions will remain in full force and effect. Any amendment or waiver under this license shall be in writing and signed by representatives of both parties.

(v APR. 28, 2022)

15.3.1 Exhibit A

SOFTWARE includes the following open source/ freeware that are subject to specific license conditions listed in the table below, which may be updated from time to time by NVIDIA Mellanox or the Open Source provider. The below table is current as of December 2021. To obtain source code for software provided under licenses that require redistribution of source code, including the GNU General Public License or for update queries contact: http://www.mellanox.com/page/gnu_code_request .This offer is valid for a period of three (3) years from the date of the distribution of this product by NVIDIA Mellanox.

Component name	Version	Home Page	License
@candlefw/wick	0.8.12	https://github.com/galactrax/cfw-wick#readme	MIT License
ABSender	master-20121122	https://github.com/100Continue/ABSender	Apache License 2.0
APBS	apbs-0.3.1	https://sourceforge.net/projects/apbs	GNU General Public License v2.0 or later
Amazon Kindle Source Code	6.2	http://www.amazon.com/gp/help/customer/display.html?nodeId=200203720	Apache License 2.0
Amiga Research OS	20120217	https://aros.sourceforge.io/license.html	Aros Public License V 1.1
Apache ActiveMQ	2.2.2	http://activemq.apache.org/	Apache License 2.0
Apache HTTP Server	1.3.7, 1.3.8	http://httpd.apache.org/	Apache License 1.0
Apache HTTP Server	2, 2.0.11, 2.0.23, 2.0.25, 2.0.26, 2.0.30, 2.0.33, 2.0.35, 2.0.36, 2.0.38, 2.0.39, 2.0.40, 2.0.41, 2.0.43, 2.1.0	http://httpd.apache.org/	Apache License 1.1
Apache HTTP Server	2.0.59, 2.1.1, 2.1.10, 2.1.2, 2.1.3, 2.1.4, 2.1.5, 2.1.6, 2.1.7, 2.1.8, 2.1.9, 2.2.1, 2.2.2 2.2.12, 2.2.13, 2.2.14, 2.2.15, 2.2.16, 2.2.17, 2.2.22, 2.2.26, 2.2.3, 2.2.4, 2.2.5, 2.2.6, 2.2.7, 2.2.9, 2.3.0, 2.3.1, 2.3.4	http://httpd.apache.org/	Apache License 2.0
Apache HTTP Server	STRIKER_2_1_0_RC1	http://httpd.apache.org/	Apache License 2.0

Component name	Version	Home Page	License
Apache Portable Runtime	0.9.13, 0.9.15, 1.2.0, 1.2.10, 1.2.11, 1.2.12, 1.2.7, 1.2.8, 1.2.9, 1.3.0, 1.3.1, 1.3.10, 1.3.12, 1.3.2, 1.3.3, 1.3.4, 1.3.5, 1.3.7, 1.3.8, 1.3.9, 1.4.7, 1.5.1, 1.5.2; APR_1_0_RC2; JCW_0_9_5_PRE1	http://apr.apache.org/	Apache License 2.0
Apache Portable Runtime	0.9.4 APACHE_2_0_37 APACHE_2_0_40 APACHE_2_0_44 APACHE_2_0_48	http://apr.apache.org/	Apache License 1.1
Apache Portable Runtime	APU_1_0_RC1	http://apr.apache.org/	(MIT License AND RSA Message-Digest License AND Apache License 2.0 AND Beerware License AND RSA MD4 or MD5 Message-Digest Algorithm License AND Christian Michelsen Research License AND Apache License 1.1)
Apache Tomcat	1.1.0, 6.0.24	http://tomcat.apache.org/	Apache License 2.0
BIND9 (Berkeley Internet Name Domain)	9.9.11	https://www.isc.org/wordpress/software/bind/	Mozilla Public License 2.0
Berkeley DB	4.5.20	http://www.oracle.com/technology/products/berkeley-db/db/index.html	BSD 3-clause "New" or "Revised" License
Chromium (Google Chrome)	32.0.1700.102	http://code.google.com/chromium/	BSD 3-clause "New" or "Revised" License
Cinder	v0.8.0	http://libcinder.org	BSD 3-clause "New" or "Revised" License

Component name	Version	Home Page	License
Clonezilla	1.2.10	http://clonezilla.org/	GNU General Public License v3.0 or later
Cron	3.0pl1	https://alioth.debian.org/projects/pkg-cron/	Cron License
CyanogenMod - android_external_busybox	cm-10.1-M1, cm-10.1-M2	https://github.com/CyanogenMod/android_external_busybox/blob/cm-12.0/LICENSE	GNU General Public License v2.0 or later
D-Bus	1.2.6	http://www.freedesktop.org/wiki/Software/dbus	Academic Free License v2.1
DHCP (ISC)	4.3.6	http://www.isc.org/downloads/dhcp/	ISC License
Darik's Boot and Nuke	dban-2.0.0	http://sourceforge.net/projects/dban	(GNU Lesser General Public License v3.0 or later AND GNU General Public License v3.0 or later)
Debian Games	11.04.1+repack	http://wiki.debian.org/Games	BSD 3-clause "New" or "Revised" License
FLAC - Free Lossless Audio Codec	flac-1.1.1-beta1-src	http://flac.sourceforge.net	BSD 3-clause "New" or "Revised" License
FarGroup/ FarManager	builds/3.0.2890	https://github.com/FarGroup/FarManager/blob/master/LICENSE	BSD 3-clause "New" or "Revised" License
FreeBSD	5.5, 6, 9.0-BETA1, release/11.2.0,12.2, 2.2.0, 2.2.6, 5.0.0cvs	https://github.com/trueos/trueos	BSD 2-clause "Simplified" License
FreeBSD	bsd_44_lite	https://github.com/trueos/trueos	BSD 4-clause "Original" or "Old" License
FreeBSD Ports	RELEASE_4_5_0 RELEASE_4_6_0	https://www.freebsd.org/ports/	BSD 2-clause FreeBSD License
FreeNAS	0.7	https://www.freenas.org/	BSD 3-clause "New" or "Revised" License
GD	2.0.1beta, 2.0.32, 2.0.33, 2.0.34RC1, 2.0.35, 2.0.35RC5	http://www.libgd.org	GD License
GD	2.0.36_rc1	http://www.libgd.org	(X11 License OR MIT License)
GLib	1.2.3, 2.14.6, 2.19.5	http://library.gnome.org/devel/glib/	Apache License 2.0
GNU Compiler Collection	4.7.0	http://gcc.gnu.org/	(GD License OR Unknown License)
GNU Libtool	1.4.1	http://www.gnu.org/software/libtool/	BSD 3-clause "New" or "Revised" License

Component name	Version	Home Page	License
GNU Parted	1.8.1, 2.4	http://www.gnu.org/software/parted	GNU General Public License v2.0 or later
GNU Parted	2.4	http://www.gnu.org/software/parted	GNU General Public License v3.0 or later
Gentoo Linux	release_1_3_17	https://www.gentoo.org/	GNU General Public License v2.0 or later
Heimdal Kerberos	heimdal-0.0n	http://www.h5l.org/	BSD 3-clause "New" or "Revised" License
HipHop Virtual Machine for PHP	HHVM-3.1.0	https://github.com/facebook/hhvm	(PHP License v3.01 AND Zend License v2.0)
Kablank	1.1 Alpha1	https://www.kablank.org/	Apache License 2.0
Less	374	http://www.greenwoodsoftware.com/less/	BSD 2-clause "Simplified" License
Less	429	http://www.greenwoodsoftware.com/less/	GNU General Public License v2.0 or later OR Less License
LineageOS	cm-10.1.0-RC1	https://lineageos.org/	(FSF Unlimited License AND BSD 3-clause "New" or "Revised" License)
Linux Test Project	2004	https://github.com/linux-test-project/ltp	GNU General Public License v2.0 or later
Linux-Pam	0.59, 0.72, 0.74, 0.76, 0.99.1.0, 0.99.2.0, 0.99.4.0, 0.99.5.0, 0.99.6.1, 0.99.6.2, 1.0.0	http://www.linux-pam.org	BSD 3-clause "New" or "Revised" License
Linux-Pam	1.0.1	http://www.linux-pam.org	(X11 License AND FSF Unlimited License)
MapServer	rel-1-0-0	http://mapserver.org	(X11 License AND MIT License)
Merruk-Technology	2.0-20121113	http://www.merruk.ma	GNU General Public License v2.0 only
MinGW - Minimalist GNU for Windows	binutils-2.20	http://mingw.sourceforge.net/	Public Domain
MythTV	v0.13	http://www.mythtv.org	GNU General Public License v2.0 or later
NFS	1.0.6	http://linux-nfs.org/	GNU General Public License v2.0 or later

Component name	Version	Home Page	License
Net-SNMP	5.0.9, 5.4.2.1, 5.5.2.pre1, 5.7.3, END-UCD-SNMP. Ext-5-3-cvs20050331, JBPN-CBL-1, 5.0.11.1, 5.2.2	http://www.net-snmp.org	(CMU License AND BSD 3-clause "New" or "Revised" License)
Net-SNMP	5.1.2, Ext-5-0, Ext-5-0-2, Ext-5-0-4, Ext-5-4-1-1, V4-2-patches-merge2	http://www.net-snmp.org	(Diffstat License OR BSD 3-clause "New" or "Revised" License)
Net-SNMP	Ext-5-0, Ext-5-0-4	http://www.net-snmp.org	(Diffstat License AND BSD 3-clause "New" or "Revised" License AND Christian Michelsen Research License)
Net-SNMP	Ext-5-4-1-1	http://www.net-snmp.org	(Diffstat License AND BSD 3-clause "New" or "Revised" License AND Christian Michelsen Research License AND Bzip2 License)
Net-SNMP	V4-2-patches-merge2	http://www.net-snmp.org	Diffstat License AND Christian Michelsen Research License)
Net-SNMP	5.2.4 source code, 5.2.5 pre-releases, 5.3.1, 5.3.2 pre-releases, 5.4.2 pre-releases, 5.5, Ext-4-0-pre5, Ext-4-1-pre1, Ext-5-0-2-pre1, Ext-5-0-7-pre1, Ext-5-0-8-pre1, Ext-5-2-2rc6, Ext-5-2-pre2, Ext-5-2-pre3, Ext-5-3-pre1, Ext-5-3-pre3, Ext-5-3-pre4, Ext-5-4-1-pre1, Ext-5-4-1-pre3, Ext-5-4-pre1, Ext-5-4-pre1, Ext-5-4-pre4, Ext-5-5-pre1, Ext-5-5-pre2, Ext-5-5-pre3, Ext-5-5-rc1, Ext-5-5-rc3, 5.3.0.1. 5.8.1.pre1, 5.8.1.pre2	http://www.net-snmp.org	BSD 3-clause "New" or "Revised" License
NetBSD	1.1, 1.5, 2	http://www.netbsd.org	BSD 3-clause "New" or "Revised" License

Component name	Version	Home Page	License
OpenFabrics Enterprise Distribution - OFED	1.2, 1.5, 3.3.2018	https://www.openfabrics.org/downloads/rdmacm/	BSD 2-clause "Simplified" License
OpenFabrics Enterprise Distribution - OFED	3.1.8	https://www.openfabrics.org/downloads/rdmacm/	BSD 3-clause "New" or "Revised" License
OpenLDAP	2.4.44	http://www.openldap.org/	Open LDAP Public License v2.8
OpenSSH	5.3p1, 7.4p1,7.7, 7.7p1, 7.8, 7.8p1, 7.9, 7.9p1, 8.0p1, pre-reorder	http://www.openssh.com/	BSD 3-clause "New" or "Revised" License
OpenSSH	7.2p2, 7.6p1	http://www.openssh.com/	X11 License
OpenWrt	12.09, 14.07	http://openwrt.org/	GNU General Public License v2.0 or later
PCRE	7.1, 7.4, 7.6	http://www.pcre.org/	PCRE License
PCRE	4, 7.6, 7.7, 7.8	http://www.pcre.org/	BSD 3-clause "New" or "Revised" License
PHP	MERGE_FROM_NEW_LO OK_2001_TAG_1	http://svn.php.net	BSD 2-clause "Simplified" License
PortableApps.com	WinMerge 2.10.0 , 2.6.12Source	http://portableapps.com/	Apache License 2.0
Python programming language	v2.4a2	https://www.python.org	Python Software Foundation License 2.0
Qualcomm Kernel Tree for MSM/QSD family and Android 4.4	ath-201808291719	https://www.codeaurora.org/projects/all-active-projects/linux-msm	ISC License
TACACS+ client library and PAM module	1.2.10, 1.2.9	https://sourceforge.net/projects/tacplus	BSD 3-clause "New" or "Revised" License
Stephane-D/SGDK	V1.62	https://github.com/Stephane-D/SGDK/blob/master/license.txt	MIT License
TACACS+ client library and PAM module	1.3.2	https://sourceforge.net/projects/tacplus	GNU General Public License v2.0 or later
Tarifa	Tarifa019.tar	http://sourceforge.net/projects/tarifa	GNU General Public License v2.0 or later
Tcl/Tk	8.1.1	http://www.tcl.tk/	TCL/TK License
Tecla Library	1.2.3, 1.4.0, 1.4.1, 1.5.0, 1.6.0, 1.6.2	http://www.astro.caltech.edu/~mcs/tecla/index.html	MIT License

Component name	Version	Home Page	License
The GWARE Project	2.10.2	http://sourceforge.net/projects/gware	GNU Lesser General Public License v2.1 or later
TizenRT	1.1_Public_Release	https://github.com/Samsung/TizenRT	Apache License 2.0
UC-7402.7408.7410.7420-LX Plus Source	20100210	http://www.moxa.com/product/UC-7408.htm	GNU General Public License v2.0 only
WinMerge	2.11.1.7	https://winmerge.org/	Apache License 2.0
XAMPP	1.4.5, 1.6.4	https://www.apachefriends.org/index.html	BSD 3-clause "New" or "Revised" License
XAMPP	1.6.4	https://www.apachefriends.org/index.html	GNU General Public License v2.0 or later
XQilla	1.1.0	http://xqilla.sourceforge.net	BSD 3-clause "New" or "Revised" License
YaST	broken/svn/openSUSE-9_3	http://opensuse.org/YaST	MIT License
Zile (Zile is Lossy Emacs)	1.4, 1.5, 1.5.2, 1.5.3, 1.6, 1.6.1, 1.6.2	http://zile.sourceforge.net	GNU General Public License v2.0 or later
afwall	V2.6.0.1, v2.8.0, v2.9.0, v2.9.1, v2.9.4	https://github.com/ukanth/afwall	MIT License
alcatel	20	http://www.alcatel-mobilephones.com/	Apache License 2.0
alcatel	4/18/2012, 20120601, 918	http://www.alcatel-mobilephones.com/	GNU General Public License v2.0 or later
appweb	3.0B.0-0	http://code.google.com/p/appweb	Apache License 2.0
asuswrt-merlin	376.48, 376.48, 380.62	https://github.com/RMerl/asuswrt-merlin	Artistic License 1.0
asuswrt-merlin	378.51, 380.62	https://github.com/RMerl/asuswrt-merlin	GNU General Public License v2.0 or later
avahi	v0.6	http://avahi.org	GNU Lesser General Public License v2.1 or later
awokengazebo-lfi	lfi-20080723	http://www.awokengazebo.com/software/lfi/	BSD 4-clause "Original" or "Old" License
beefproject	beef-0.4.3.1	http://beefproject.com	Apache License 2.0
bitswitcher	0.2.0, 0.3.0, 0.3.3	http://sourceforge.net/projects/bitswitcher	GNU General Public License v2.0 or later
buildroot-kindle	master-20130206	https://github.com/twobob/buildroot-kindle	GNU General Public License v2.0 or later

Component name	Version	Home Page	License
busybox	1.10.0, 1.12.0, 1.2.0, 1.4.0, 1.5.0, 1.8.0, 1_11_0, 1_13_0, 1_14_1, 1_16_0, 1_17_1, 1_17_2, 1_18_0, 1_18_2, 1_19_0, 1_19_1, 1_19_4, 1_20_2, 1_21_0, 1_24_0, 1_29_0, 1_3_0, 1_7_0	https://github.com/mirror/busybox	GNU General Public License v2.0 only
busybox	1_14_0, 1_15_0, 1_17_0, 1_19_2, 1_19_3, 1_20_0, 1_20_1, 1_28_0,	https://github.com/mirror/busybox	GNU General Public License v2.0 or later
catboost/catboost	v0.2	https://catboost.ai	Apache License 2.0
curl	7.16.0	https://curl.se/	curl License
decorator-ko	26, 28	http://jinsell.tistory.com/372	Public Domain
file	5.22	http://www.darwinsys.com/file/	Fine Free File Command License
fluxcapacitor	0	https://github.com/majek/fluxcapacitor	MIT License
fvpawds : fvpaw Webdev Server	fvpawds v0.1.4	http://sourceforge.net/projects/fvpawds	Apache License 2.0
generator-minxing	1.0.2	https://github.com/yeoman/generator-minxing#readme	Apache License 2.0
geonkick	2.3.6	https://github.com/iurie-sw/geonkick	GNU General Public License v3.0 or later
hostap-ct	If-5.1.7, If-5.3.3, If-5.3.3b, If-5.3.4, If-5.3.5	https://github.com/greearb/hostap-ct	BSD 3-clause "New" or "Revised" License
hostapd	hostap_0_5_2, hostap_0_5_3, hostap_0_5_6,	http://w1.fi/hostapd/	GNU General Public License v2.0 or later
howl	0.9.4, 0.9.6, 0.9.7, 0.9.9, 1.0.0, 0.9.3, 0.9.1	https://howl.io	BSD 3-clause "New" or "Revised" License
illumos-joyent	20121101	http://www.illumos.org/projects/illumos-gate	Common Development and Distribution License 1.0
krb5/krb5	1.0-alpha3, 1.0-beta2, 1.0-beta5	https://github.com/krb5/krb5	Krb5-MIT License
libevent - an event notification library	0.1, 1.0d, 1.0e, 1.4.1-beta	http://libevent.org/	BSD 3-clause "New" or "Revised" License
libexpat	1.95.0, 1.95.1, 1.95.2, 2.0.0, v19991013	http://www.libexpat.org/	Expat License

Component name	Version	Home Page	License
libexpat	V19991013	http://www.libexpat.org/	Mozilla Public License 1.1
linux-yocto-dev	v2.6.12	http://git.yoctoproject.org/cgit/cgit.cgi/linux-yocto-dev/	GNU General Public License v2.0 with Linux Syscall Note
littlekernel-m900-eclair	master-20110326	http://github.com/LouZiffer/littlekernel-m900-eclair	GNU General Public License v2.0 only
lmbd	0.9.18	http://syomas.com/mdb/	Open LDAP Public License
math-linux	0.0.1	http://sourceforge.net/projects/math-linux	GNU General Public License v3.0 or later
mod_dup	2.5.0	http://github.com/Orange-OpenSource/mod_dup/	Apache License 2.0
ngx_pagespeed	1.9.32.4-dbg-ssl-crash	https://github.com/pagespeed/ngx_pagespeed	Apache License 2.0
nss_ldap	253	https://github.com/PADL/nss_ldap	GNU Library General Public License v2 or later
opensm	3.3.17	http://www.openfabrics.org/	BSD 2-clause "Simplified" License
pGina	Plugin Bundle 05-11-2006	http://pgina.org/	MIT License
pam_radius	release_2_0_0	http://freeradius.org/pam_radius_auth/	GNU General Public License v2.0 only
protovis	3.3.1	http://mbostock.github.io/protovis/	BSD 3-clause "New" or "Revised" License
root-project	5-13-04e	https://root.cern	(GNU Lesser General Public License v2.1 or later AND MIT License AND GNU General Public License v2.0 or later)
rsyslog	sysklogd-141-import	https://www.rsyslog.com/	GNU General Public License v2.0 or later
rtems-libbsd	5.1	http://git.rtems.org/rtems-libbsd.git/	Apache License 2.0
rtl8186 - toolchain	0.5.5_src	http://rtl8186.sourceforge.net	GNU General Public License v2.0 or later
snake-os	0.9	http://code.google.com/p/snake-os/	GNU General Public License v2.0 or later

Component name	Version	Home Page	License
ssmtp	2.61	http://packages.qa.debian.org/s/ssmtp.html	GNU General Public License v2.0 or later
svn://svn.tug.org/texlive/trunk	texlive-2009.0	http://www.tug.org/texlive/	LaTeX Project Public License - Version Unspecified
util-linux	2.11q, 2.11w, 2.12a, 2.13-pre1	https://en.wikipedia.org/wiki/Util-linux	GNU General Public License v2.0 or later
videolan/vlc	0.5.0	https://github.com/videolan/vlc	(GNU Lesser General Public License v2.1 or later AND GNU General Public License v2.0 or later)
wakame-vdc	v13.06.0	http://wakame.axsh.jp/	Unknown License
wpa_supplicant - IEEE 802.1X, WPA, WPA2, RSN, IEEE 802.11i	0.5.0, 0.5.3, 0.5.5, 0.5.6, 0.5.8, 0.6.0, 0.6.10, 0.6.2, 0.6.3, 0.6.4, 0.6.8, 0.7.0, 0.7.1, 0.7.2, 0.7.3, 1, 2, 2.1, 2.2, 2.3, 2.4, 2.5, 2.6, 2.7, 2.7+git20190108+11ce7a1, , 2.7-git20180504+60a5737, 2.7-git20180606+b915f2c, 2.7-git20180706+420b5dd	http://w1.fi/wpa_supplicant/	BSD 3-clause "New" or "Revised" License
xorp.ct	1.5, xorp-1-7	http://www.candelatech.com/xorp.ct	MIT License
zeroconf	0.9	https://files.pythonhosted.org/packages/20/d7/418ff6c684ace0f5855ec56c66cfa99ec50443c41693b91e9abcccfa096c/zeroconf-0.20.0.tar.gz	GNU General Public License v2.0 or later

Notice

This document is provided for information purposes only and shall not be regarded as a warranty of a certain functionality, condition, or quality of a product. Neither NVIDIA Corporation nor any of its direct or indirect subsidiaries and affiliates (collectively: "NVIDIA") make any representations or warranties, expressed or implied, as to the accuracy or completeness of the information contained in this document and assumes no responsibility for any errors contained herein. NVIDIA shall have no liability for the consequences or use of such information or for any infringement of patents or other rights of third parties that may result from its use. This document is not a commitment to develop, release, or deliver any Material (defined below), code, or functionality.

NVIDIA reserves the right to make corrections, modifications, enhancements, improvements, and any other changes to this document, at any time without notice. Customer should obtain the latest relevant information before placing orders and should verify that such information is current and complete.

NVIDIA products are sold subject to the NVIDIA standard terms and conditions of sale supplied at the time of order acknowledgement, unless otherwise agreed in an individual sales agreement signed by authorized representatives of NVIDIA and customer ("Terms of Sale"). NVIDIA hereby expressly objects to applying any customer general terms and conditions with regards to the purchase of the NVIDIA product referenced in this document. No contractual obligations are formed either directly or indirectly by this document.

NVIDIA products are not designed, authorized, or warranted to be suitable for use in medical, military, aircraft, space, or life support equipment, nor in applications where failure or malfunction of the NVIDIA product can reasonably be expected to result in personal injury, death, or property or environmental damage. NVIDIA accepts no liability for inclusion and/or use of NVIDIA products in such equipment or applications and therefore such inclusion and/or use is at customer's own risk.

NVIDIA makes no representation or warranty that products based on this document will be suitable for any specified use. Testing of all parameters of each product is not necessarily performed by NVIDIA. It is customer's sole responsibility to evaluate and determine the applicability of any information contained in this document, ensure the product is suitable and fit for the application planned by customer, and perform the necessary testing for the application in order to avoid a default of the application or the product. Weaknesses in customer's product designs may affect the quality and reliability of the NVIDIA product and may result in additional or different conditions and/or requirements beyond those contained in this document. NVIDIA accepts no liability related to any default, damage, costs, or problem which may be based on or attributable to: (i) the use of the NVIDIA product in any manner that is contrary to this document or (ii) customer product designs.

No license, either expressed or implied, is granted under any NVIDIA patent right, copyright, or other NVIDIA intellectual property right under this document. Information published by NVIDIA regarding third-party products or services does not constitute a license from NVIDIA to use such products or services or a warranty or endorsement thereof. Use of such information may require a license from a third party under the patents or other intellectual property rights of the third party, or a license from NVIDIA under the patents or other intellectual property rights of NVIDIA.

Reproduction of information in this document is permissible only if approved in advance by NVIDIA in writing, reproduced without alteration and in full compliance with all applicable export laws and regulations, and accompanied by all associated conditions, limitations, and notices.

THIS DOCUMENT AND ALL NVIDIA DESIGN SPECIFICATIONS, REFERENCE BOARDS, FILES, DRAWINGS, DIAGNOSTICS, LISTS, AND OTHER DOCUMENTS (TOGETHER AND SEPARATELY, "MATERIALS") ARE BEING PROVIDED "AS IS." NVIDIA MAKES NO WARRANTIES, EXPRESSED, IMPLIED, STATUTORY, OR OTHERWISE WITH RESPECT TO THE MATERIALS, AND EXPRESSLY DISCLAIMS ALL IMPLIED WARRANTIES OF NONINFRINGEMENT, MERCHANTABILITY, AND FITNESS FOR A PARTICULAR PURPOSE. TO THE EXTENT NOT PROHIBITED BY LAW, IN NO EVENT WILL NVIDIA BE LIABLE FOR ANY DAMAGES, INCLUDING WITHOUT LIMITATION ANY DIRECT, INDIRECT, SPECIAL, INCIDENTAL, PUNITIVE, OR CONSEQUENTIAL DAMAGES, HOWEVER CAUSED AND REGARDLESS OF THE THEORY OF LIABILITY, ARISING OUT OF ANY USE OF THIS DOCUMENT, EVEN IF NVIDIA HAS BEEN ADVISED OF THE POSSIBILITY OF SUCH DAMAGES. Notwithstanding any damages that customer might incur for any reason whatsoever, NVIDIA's aggregate and cumulative liability towards customer for the products described herein shall be limited in accordance with the Terms of Sale for the product.

Trademarks

NVIDIA, the NVIDIA logo, and Mellanox are trademarks and/or registered trademarks of NVIDIA Corporation and/or



Mellanox Technologies Ltd. in the U.S. and in other countries. Other company and product names may be trademarks of the respective companies with which they are associated.

Copyright

© 2024 NVIDIA Corporation & affiliates. All Rights Reserved.

